



CORECO

2021

RECINTOS FRIGORÍFICOS COLD ROOMS

Tarifa de precios / *price list*
01-06-2023

Equipamientos y sistemas de frío comercial
Equipment & commercial cooling systems



infinite projects by coreco

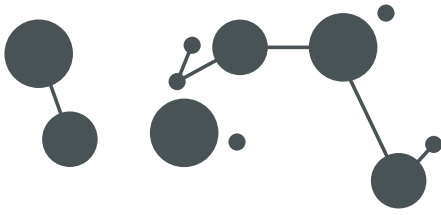

CORECO amplia la gama de recintos frigoríficos, presentando el sistema de unión de paneles por sin columnas, como alternativa a nuestro tradicional concepto de montaje con columnas

Esta nueva solución estructural, pone en el mercado una alternativa tan eficiente como la tradicional, mantiene la modularidad que permite cubrir las necesidades de espacio que cada instalación requiere

CORECO expanded the range of products, providing an alternative to our traditional system for mounting panels with columns. This new structural conception, puts on the market an alternative as efficient as the traditional one, keeping the modularity that let you find the proper solution to your needs

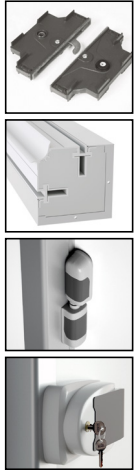

RFM-S

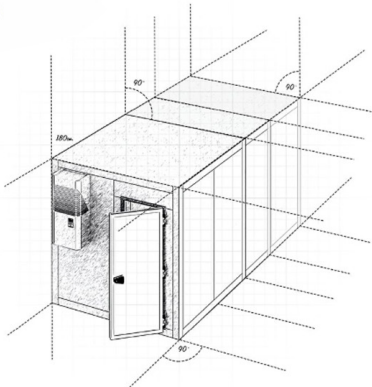
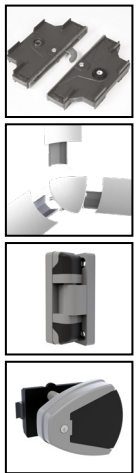

Esta aplicación web le permitirá configurar una cámara frigorífica en muy poco tiempo siguiendo unos sencillos pasos. Una vez finalizado el proceso, deberá rellenar un formulario indicando algunos datos básicos de contacto con el fin de que podamos proporcionarle un presupuesto acorde a sus necesidades.

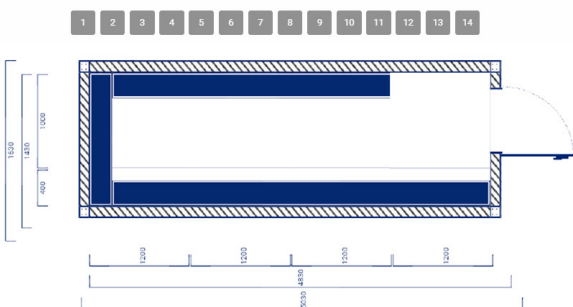

Seguimos evolucionando la herramienta de configuración que, desde PC o dispositivo móvil, le permite componer su cámara y recibir por correo electrónico un completo informe con la información más relevante:

- Dimensiones y volumen
- Tipo y acabados del suelo
- Composición de paneles
- Posición y apertura de la puerta
- Configuración de estanterías
- Equipo frigorífico recomendado

coldrooms.coreco.es



We continue updating the configuration tool that, from PC or mobile device, allows you to compose your camera and receive by email a complete report with the most relevant information:

- Dimensions and volume
- Type and floor finishes
- Composition of panels
- Position and opening of the door
- Shelving configuration
- Recommended refrigeration equipment

HISTORIA - HISTORY

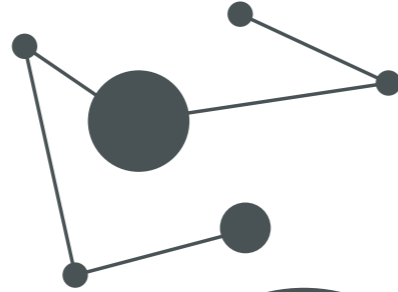

CORECO es una empresa creada en 1986. Todos estos años han significado una continua evolución tecnológica y un gran crecimiento empresarial en pro de ofrecer a nuestros clientes el mejor de los productos.

En el continuo servicio y atención a nuestros clientes, seguimos desarrollando nuevos modelos recogidos en nuestro índice de novedades, que completan una oferta de productos de gran eficiencia energética respetuosos con la conservación del medio ambiente

The CORECO company was established in 1986. Our many years of experience have seen constant technological development and continued business growth offering our customers the best products on the market.

Years of continuous service and attention to our customers mean we have continued to develop new models, as shown in our table of contents, which complement our wide range of products that are highly energy efficient and environmentally friendly.

INSTALACIONES - FACILITIES



CORECO, es una empresa española con presencia comercial en los cinco continentes.

El presente catálogo comprende cuatro apartados, donde se presentan productos enfocados a la industria de la hostelería y alimentación.

Nuestras instalaciones se han reunificado en dos centros productivos, uno de ellos en plena ampliación cubre un total de 23.000 m², más otros 8.000 m² de zonas para uso social y logístico.

Nuestro segundo centro (Centro 2) cubre un total de 7.500 m² de los cuales 1.500 están destinados a zona logística.

La estructura comercial de la que disponemos está formada por 16 delegaciones que cubren todo el territorio nacional, otras 3 en Europa y estamos presentes en más de 70 países.

Este esfuerzo inversor y tecnológico es el que ponemos a su servicio, representado por el presente catálogo, que esperamos sea una herramienta útil para su negocio.

CORECO is a Spanish company commercially present in 5 continents.

This catalogue includes four sections containing products focused on the hospitality and food industry, which fulfil all installation needs, with maximum accuracy and productivity, according to the use they have been designed for.

We have consolidated our installations in two production centres, one still expanding, with 23,000m², and another with 8,000m² for logistics and social use.

Our commercial structure consists of 16 delegations, that cover the entire national territory, another 3 in Europe and we are present in over 70 countries.

The investment and technological effort that we put into our service, is shown by in our catalogue that we hope will be a useful tool for your business.

FERIAS INTERNACIONALES - INTERNATIONAL EXHIBITIONS

En CORECO creemos además en la necesidad de participar año tras año en las manifestaciones comerciales más importantes, tanto nacionales como internacionales con el objeto de mantener el continuo contacto con nuestros colaboradores, así como de mostrar las novedades más recientes incorporadas a nuestro extenso catálogo.

At CORECO we also believe in the need to take part in the most relevant national and international trade events held each year in order to keep permanently in touch with our collaborators, as well as to show the most recent innovations included in our extensive catalogue.

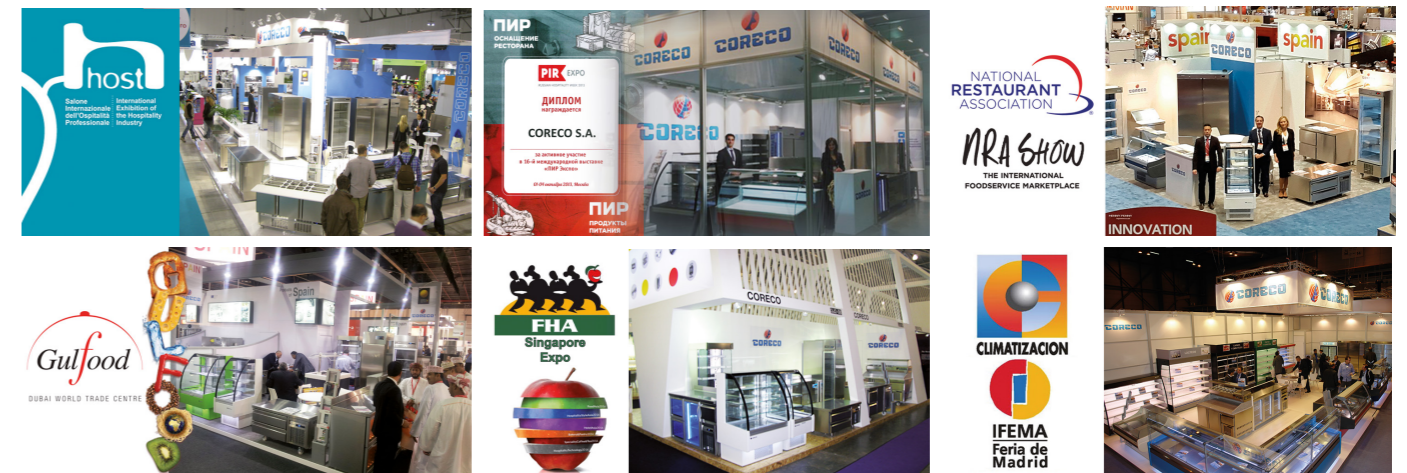

Italy, Milan Covered areas: Europe, America, Asia-Oceania, Middle East and Africa

Italia, Milán. Áreas cubiertas: Europa, América, Asia-Oceania, Oriente medio y África



(PIR) Russia, Moscow. Covered areas Europe and Eastern European countries

(PIR) Rusia, Moscú. Áreas cubiertas: Europa y países de Europa del Este.



United Arab Emirates, Dubai. Covered areas: Middle East, Africa

Emiratos Árabes Unidos, Dubai. Áreas cubiertas: Oriente Medio, África



Singapore Expo. Covered areas: Asia-Oceania

Singapore Expo. Áreas cubiertas: Asia-Oceania



USA. Covered areas: Nord, center and sud america

EE.UU. Áreas cubiertas: Norte, centro y sudamérica



IFEMA, Madrid. Covered areas: Spain and Portugal

IFEMA, Madrid. Áreas cubiertas: España y Portugal



CERTIFICACIÓN como herramienta competitiva CERTIFICATION as a competitive value

Tenemos muy presente que gran parte de nuestro desarrollo es debido al alto nivel tecnológico de nuestros productos. Para ello y cumpliendo con la más estricta normativa internacional, tenemos implantados altos estándares de calidad, utilizando para ello los más sofisticados medios de control a nuestra disposición. Cada proceso de fabricación es supervisado de forma minuciosa para optimizar tanto el rendimiento como el consumo de energía.

En consecuencia, CORECO ha obtenido homologación y certificaciones nacionales e internacionales en normas de higiene, seguridad eléctrica, compatibilidad electromagnética y medioambiental, lo que nos permite exportar a cualquier país del mundo.

Nuestros fabricados cumplen con la actual normativa de la U.E. incorporando la marca de homologación europea.

Our products comply with current E.U. regulations, and incorporate European homologation marking.



We are fully aware that most of our development is due to the high technology level of our products. To this end, and in compliance with the most stringent international regulations, we have implemented high quality standards, using the most sophisticated means of control at our disposal. Each manufacturing process is carefully supervised in order to optimise both performance and energy consumption.

As a result, CORECO has been granted national and international homologations and certifications in hygiene, electrical safety, electromagnetic compatibility, and environmental standards, which enables us to export to any country in the world.

La calidad y seguridad de nuestros productos y empresa, está asegurada mediante el cumplimiento de las normas certificadas y auditadas por Bureau Veritas:

ISO-9001 : 2015
ISO 14001 : 2015
ISO 45001 : 2018

y las directivas correspondientes al mercado CE en cuanto a seguridad eléctrica y compatibilidad electromagnética, y sus correspondientes a países como Arabia Saudí, Qatar, Kuwait y Rusia.

Los productos fabricados por CORECO, han obtenido homologación en normas de higiene y seguridad eléctrica tan restrictivas y exigentes como son las americanas, estando homologados por ETL. Esto nos permite exportarlos a países de centro y Norte América.

The quality and safety of our products and company is guaranteed by complying with standards certified and audited by Bureau Veritas:

ISO-9001 : 2015
ISO 14001 : 2015
OHSAS 18001 : 2007

and with the relevant directives concerning EU marking in terms of electrical safety and electromagnetic compatibility, and their corresponding equivalents for countries such as Saudi Arabia, Qatar, Kuwait, and Russia.

The products manufactured by CORECO have been certified in hygiene and electrical safety standards as restrictive and demanding as American regulations, being ETL Listed. This allows us to export them to countries in Central and North America.



LABORATORIOS CERTIFICADOS - CERTIFIED LABORATORIES



El proceso de innovación no sería posible sin los laboratorios más avanzados de Europa, así como la dedicación de un experimentado equipo de investigadores.

Innovation process would not be possible without the most state-of-the-art laboratories in Europe, as well as the dedication of an experienced team of researchers.

Confiamos en que la innovación, el servicio continuo y el apoyo al cliente deben seguir siendo el sello distintivo de CORECO para afrontar los retos del futuro.

We are confident that innovation, continuous service and client support must remain as CORECO's hallmark to face the challenges of the future.

REACCIÓN AL FUEGO - FIRE REACTION

Certificación como herramienta competitiva, no es sólo una frase.

Certification as a competitive value, is not just a phrase.

En CORECO, incrementamos la oferta estándar de recintos frigoríficos, con la posibilidad de fabricarlos, bajo pedido, con grado de reacción al fuego **B-s3d0**, para dar servicio a los requisitos y clientes más exigentes.

*At CORECO, we increase the standard offer of cold rooms, with the possibility to produce them, on demand, with fire reaction **B-s3 d0** degree, to set the requirements of most exigent markets.*

Los recintos adaptados a **B-s3d0**, tendrán precios y plazos de entrega particulares.

*Cold rooms adapted to **B-s3d0**, will have particular prices and delivery time.*



Informe de Producto Tipo Report by Product Type



Laboratorio de Reacción al Fuego Reaction to Fire Laboratory

SOLICITANTE: APPLICANT: CORECO, S.A. Toledo, 25 de septiembre de 2019
Toledo, 25th of September of 2019

Clasificación de la Reacción al Fuego - Reaction to fire classification

Comportamiento al Fuego Fire behaviour	Producción de humo Smoke production	Gotas inflamadas Flaming droplets
B	s 3	d 0
B - s3 , d0		

innovation
by coreco

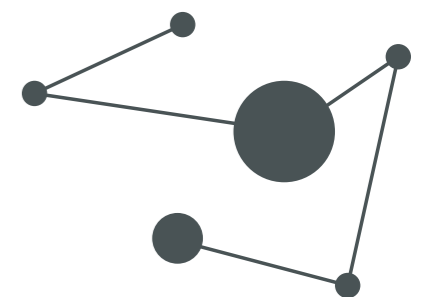

VERSATILIDAD - VERSATILITY

La versatilidad, siempre ha sido un valor añadido a la marca CORECO.

Aplicamos este valor a todos nuestros productos, y los recinto frigoríficos no son una excepción.

Cuando los modelos estándar no llegan a cubrir la necesidad de la instalación, aplicamos nuestra experiencia para dar respuesta a la exigencia que el proyecto pueda plantearnos, siempre dentro de los estándares de calidad que empleamos en la producción de paneles.

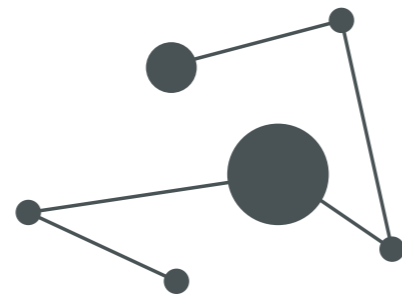

Versatility has always been an added value to the CORECO brand.

We apply this value to all our products, and cold rooms are no exception.

When the standard models do not cover the installation needs, we apply our experience to respond to the requirements that the project may pose, always within the quality standards that we use in the production of panels.

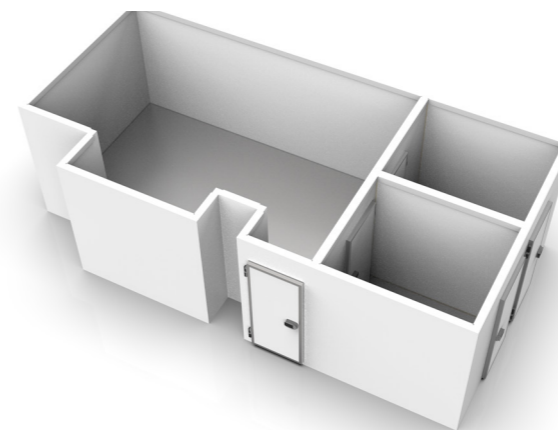
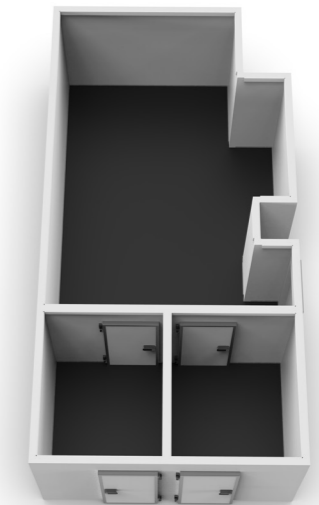
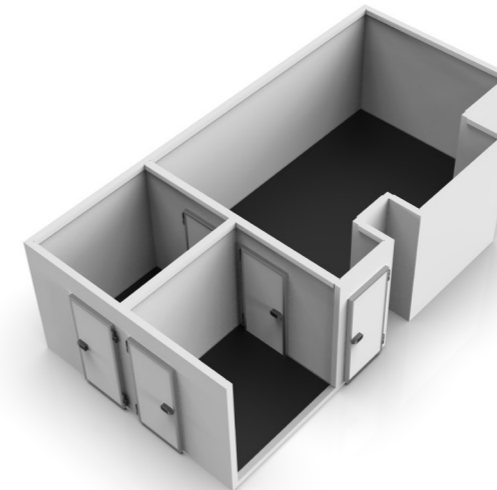
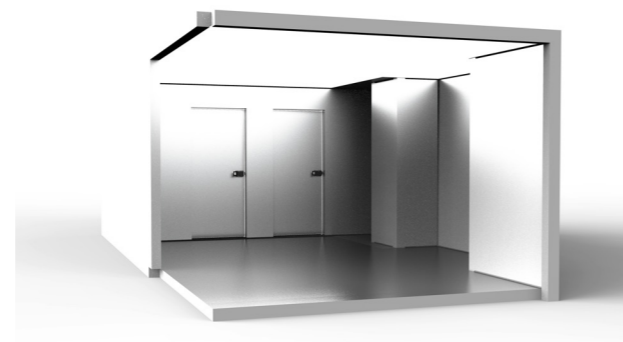
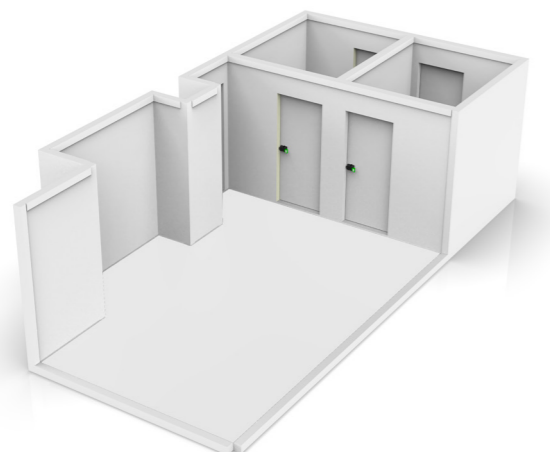
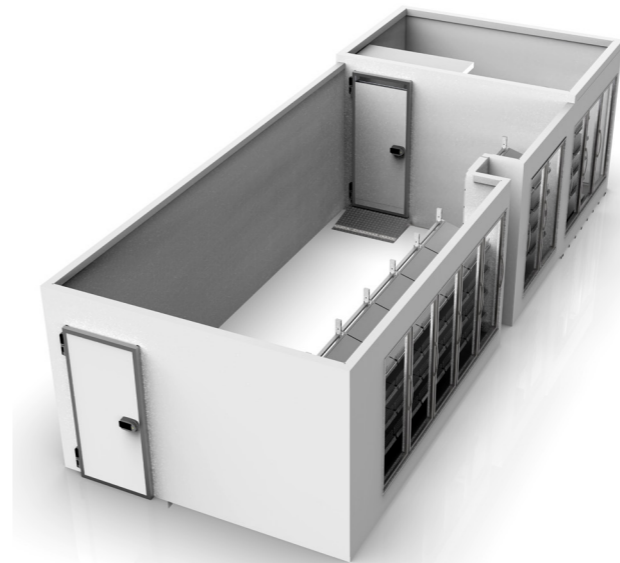
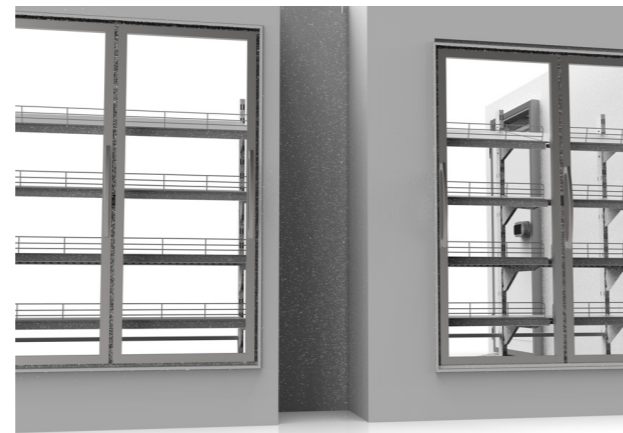
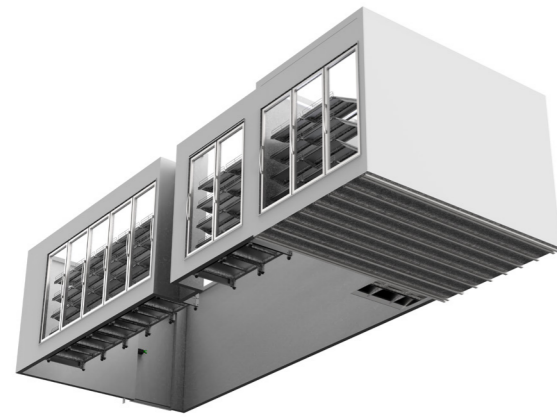

VERSATILIDAD - VERSATILITY

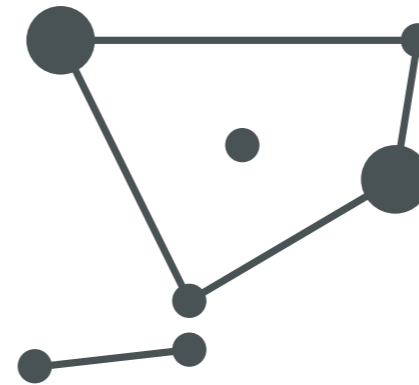
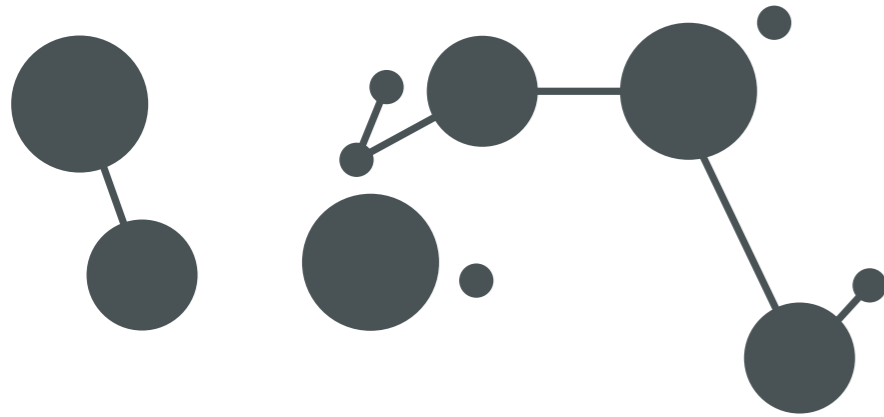

RED DE DISTRIBUCIÓN CORECO

Nuestro desarrollo comercial está basado en la venta a especialistas, distribuidores y montadores apoyados por personal de nuestras delegaciones tanto en el conocimiento del producto como en la formación técnica y un ágil servicio pos-venta y de repuestos.

CORECO DISTRIBUTION NETWORK

Our commercial development is based on the sale to specialist, distributors and assemblers supported by personal of your branches as in the product knowledge as in the technical preparation and an agile after sale service and spare parts.

Departamento comercial

Tel. + 34 957 50 22 75
Fax. + 34 957 51 42 98
comercial@coreco.es
comercial2@coreco.es

Repuestos

Tel. + 34 957 50 98 22
fjlebron@coreco.es

SAT

Tel. + 34 957 50 22 75
Ext. 143
cmartinez@coreco.es

EXPORT DEPARTMENT ● ● ●

EXPORT MANAGER

Rida Kabbaj
Mobile: +34 629 891 677
E-mail: meast@coreco.es

CORECO S.A.

Export Main Office
Tel. +34 957 510 357
Fax. +34 957 509 106
exportd@coreco.es

Technical Support

Mobile: +34 681 037 631
technical.support@coreco.es

WEST EUROPE AREA MANAGER

Rafik Tarhini
Mobile: +34 646 589 339
E-mail: europe@coreco.es

AFRICA AREA MANAGER

Guichard Montour
Mobile: +34 606 026 962
E-mail: africa@coreco.es

CENTRAL & EASTERN EUROPE AREA MANAGER

AnaGómez
Mobile: +34 628 454 435
E-mail: easteurope@coreco.es

MIDDLE EAST AREA MANAGER

Rida Kabbaj
Mobile: +34 629 891 677
E-mail: meast@coreco.es

CENTRAL & SOUTH AMERICA

Rida Kabbaj
Mobile: +34 629 891 677
E-mail: csamerica@coreco.es

USA & CANADA

Rida Kabbaj
Mobile: +34 629 891 677
E-mail: miguelalomir@coreco.es

ASIA-PACIFIC AREA MANAGER

Rafael Pérez
Mobile: +34 660 969 635
E-mail: asiapacific@coreco.es

OFFICE SUPERVISOR

Julia Ruiz
Tel. +34 957 510 357
E-mail: office.j@coreco.es

SENIOR OFFICE ASSISTANT

Alina Liashok
Tel. +34 957 510 357
E-mail: office.a@coreco.es

OFFICE ASSISTANT

Araceli Blanco
Tel. +34 957 510 173
E-mail: office.b@coreco.es

OFFICE ASSISTANT

Miguel Roldan
Tel. +34 957 510 357
E-mail: office.m@coreco.es

DELEGATIONS

CORECO Portugal

VIOTELNOX
Delegacion Coreco, S.A.
P Industrial Quinta das Rebelas
Rua Encarnação Coelho Lt 14
2830-222 Barreiro
Lisboa
Telf. 21 2943833
Fax 21 2944762
coreco.portugal@coreco.es

CORECO Francia

Codigel
Sr. Matthieu Sibille
Compagnie de Distribution Générale S.A.
ZAC du PETIT PARC
4, rue du Grand Etang
78920 ECQUEVILLY – FRANCE
Tél : +33 1.80.83.77.00
Fax: +33 1.80.83.67.0
matthieu-sibille@codigel.com

DELEGACIONES NACIONALES ● ● ●

ANDALUCÍA OCCIDENTAL

Representaciones Rosco&Olmo
Pedro Rosco Cartagena
Alcalá de Guadaira (Sevilla)
Mov. 669 466 153 delegacionandaluciaoccidental@coreco.es
info@roscoyolmo.es

DELEGACIÓN FABRICA MÁLAGA, ASTURIAS, CASTILLA Y LEÓN

CORECO S.A.
Ctra. Córdoba- Málaga Km. 80,800 14900
Lucena (Córdoba)
Tel. 957 50 22 75 (5 líneas)
Fax. 957 51 42 98
comercial@coreco.es

CORDOBA, GRANADA, JAEN

José Carlos Pineda
Camino Las Fontanillas, 5 Piso 20 Lucena (Córdoba)
Tel. 669 741 191
Fax. 957 78 01 15
j-cpineda@hotmail.com

EXTREMADURA

Hostelfrio
Fermín Guerrero Lebrón
Pol. Industrial Los Caños
C/ Guadajira Nº 41
06300 Zafra (Badajoz)
Tel. / Fax. 924 55 36 72
Mov. 607 945 431
delegacionextremadura@coreco.es
hostelfrio@hotmail.es

BALEARES

Vidal Ros Representaciones
Ricardo Peralta Palma
Gremi Cirugians i Barbers, 24
Pasaje particular, Local 15
Polígono Son Rossinyol
Tel. 971 75 45 79
Fax. 971 29 27 18
07009 PALMA DE MALLORCA
delegacionbalears@coreco.es
ricardo@vidalros.com

DELEGACIÓN CENTRO MADRID

Dexfrio, C.B.
Alberto Zorrilla 649 857 110
Angel Velasco 659 023 977
CORECO S.A.
Pol. Ind. Las Mezquitas
C/ Edison, 44
28906 Getafe (Madrid)
Tel. 91 682 47 11
Fax. 91 682 47 61
delegacioncentro@coreco.es
comercial@dexfrio.com

AVILA, CIUDAD REAL, CUENCA, GUADALAJARA, SEGOVIA, TOLEDO

Francisco Javier Bahón Larrucea
Av/ Gran Vía de Hortaleza nº5
portal P 5ªA
28033 Madrid
Mov. 616947352
fjavierbahon@gmail.com

CANARIAS

Insular Hostelería, S.L.
Jorge Cabrera 620 217 211
Andrés Cabrera 609 358 870
Arequipa, 10 Urb. Ind. El Cebadal
35008 Las Palmas de Gran Canaria
Tel. 928 47 40 30
Fax: 928 47 41 41
delegacioncanarias@coreco.es
info@insularhosteleria.es

DELEGACIÓN TENERIFE

Insular Hostelería, S.L.
Arequipa, 10 Urb. Ind. El Cebadal
35008 Las Palmas de Gran Canaria
Tel. 928 47 40 30
Fax: 928 47 41 41
Mov. 696 976 781
delegaciontenerife@coreco.es
info@insularhosteleria.es

ALMERIA

Juan Morón Hidalgo
C/Azucena, 8
Huerca de Almería
Almería
Mov. 651 408 414
moronhj@gmail.com

CATALUÑA

Pastor Intermediaciones Comerciales S.L.U.
Francisco Pastor
C/ Grand de Sant Andreu, 296-300
08090 Barcelona
Tel. 93 298 0452
Móvil: 668 581 366
delegacioncataluna@coreco.es
info@comercialpic.com

ARAGÓN

Pastor Intermediaciones Comerciales S.L.U.
Francisco Pastor
C/ Grand de Sant Andreu, 296-300
08090 Barcelona
Tel. 93 298 0452
Móvil: 668 581 366
delegacioncataluna@coreco.es
info@comercialpic.com

GALICIA

José Manuel Balay García
Avda. Alcalde Manuel Platas Varela
nº 158 15141 Villarrodris-Arteixo –L.
Coruña Comercial 687 967073
Oficina 648222128
delegaciongalicia@coreco.es
representaciones@jmbalay.com

LEVANTE

Rhostelev
Rubén Rodríguez-Rey Ferrón
Polígono Industrial Canastell
Travesía C/ Fustería, 24-26, a
C/ El Clavo 23-25 nave 5
03690 San Vicente del Raspeig
Tel. 965 67 27 24 / 649 149 245
Fax. 965 67 52 16
Mov. 639 626 121
delegacionlevante@coreco.es
rhostelev@gmail.com

NORTE

Refrimak Hostelería S.L.
Santiago Uriarte
Pol. Lezama Leguizamón
C/ Gorbeia, Nº 33
48450 Etxebarri (Vizcaya)
Tel. 944 26 20 28
Fax. 944 26 30 64
delegacionnorte@coreco.es
refrimakhosteleria@gmail.com

CONDICIONES DE VENTA - GENERAL SALES TERMS

- PEDIDOS**
 Los pedidos deberán cursarse por escrito (carta, fax o e-mail). Deberán reflejar las referencias de cada producto, indicadas en la tarifa vigente. Queda reservado a admitir pedidos de aquellos clientes que hayan incumplido anteriores contratos. Las condiciones particulares que se citen en el pedido del cliente quedarán anuladas si no se ajustan a las presentes condiciones generales de venta o que se acepten expresamente.
- PRECIOS**
 Los precios de la presente lista son de venta al público (recomendados) y figuran en Euros. Estos precios, en ningún caso, incluyen la instalación ni la puesta en marcha del material. Todos los precios se entienden sin accesorios.
- TRANSPORTE Y PORTES**
 El embalaje será el estándar. Cualquier embalaje o sistema de envío especial que sea requerido expresamente por el cliente, será a cargo de este último. Las mercancías viajan siempre por cuenta y riesgo del comprador. Recomendamos encarecidamente realice el control del estado de la mercancía en el tiempo establecido ya que, de lo contrario, Coreco S.A. declina toda responsabilidad al comprador. La reclamación por golpes o deterioro de la mercancía originados en el transporte no será aceptada, en ningún caso, si no va acompañada del comprobante de reclamación efectuada por el comprador a la agencia de transporte, dentro del plazo máximo legal de 24 horas después de la recepción de la mercancía.
- DEVOLUCIONES DE MATERIAL**
 No se aceptará ninguna devolución del material sin el consentimiento expreso y por escrito de Coreco S.A. En el caso de la aceptación de una devolución de material, todos los gastos generados, incluidos los portes correrán a cargo del cliente. Los materiales se abonarán de acuerdo con las condiciones del estado de la mercancía, reservándose Coreco S.A. el derecho a estipular el precio final del abono.
- GARANTÍA**
 Coreco S.A. se responsabilizará únicamente de los defectos de fabricación, quedando excluidos la manipulación o utilización incorrecta del material por parte del cliente o usuario. La garantía será la establecida según la ley vigente. Todo material remitido en garantía se facturará y se procederá a su correspondiente abono, una vez remitidas las piezas defectuosas y comprobadas por parte de Coreco S.A.
- CONDICIONES DE PAGO**
 Hasta la concesión de crédito a un cliente, todas las operaciones serán abonadas mediante pago anticipado. De no efectuarse el pago de las facturas en los vencimientos acordados, el cliente se hará cargo de los gastos de devolución y/o gastos de demora.
- ENVÍO DE REPUESTOS**
 Todos los repuestos se enviarán a portes debidos.
- RESERVA DE DOMINIO**
 La mercancía es propiedad y dominio de Coreco S.A. hasta el total pago de la misma por parte del cliente.
- LITIGIO**
 En este caso serán competentes los Tribunales de Lucena (Córdoba).
- INFORMACIÓN**
 Coreco S.A. se reserva el derecho a introducir, sin previo aviso, las modificaciones que crea necesarias, sin que ello perjudique a las características principales de los productos.

- ORDERS**
Orders must be submitted in writing (letter, fax or e-mail). They should reflect the references of each product, indicated in the current rate. It is reserved to accept orders from those customers who have breached previous contracts. The particular conditions cited in the customer's order will be cancelled if they do not comply with these general conditions of sale or that are expressly accepted.
- PRICES**
The prices in this list are for sale to the public (recommended) and appear in Euros. These prices, in no case, include the installation or commissioning of the material. All prices are understood without accessories.
- TRANSPORTATION AND PORTES**
The packaging will be the standard. Any packaging or special shipping system that is expressly required by the customer will be in charge of the latter. The goods always travel at the buyer's risk. We strongly recommend that you check the condition of the merchandise in the established time, otherwise Coreco S.A. declines all responsibility to the buyer. The claim for blows or deterioration of the goods originated in the transport will not be accepted, in any case, if it is not accompanied by the proof of the claim made by the buyer to the transport agency, within the maximum legal term of 24 hours after the receipt of the merchandise.
- MATERIAL RETURNS**
No return of the material will be accepted without the express written consent of Coreco S.A. In the case of the acceptance of a return of material, all expenses generated, including postage will be borne by the customer. The materials will be paid in accordance with the conditions of the state of the merchandise, reserving Coreco S.A. the right to stipulate the final price of the subscription.
- WARRANTY**
Coreco S.A. will be held responsible only for manufacturing defects, excluding the manipulation or incorrect use of the material by the customer or user. The guarantee will be established according to the current law. All material remitted as guarantee will be billed and its corresponding payment will be made, once the defective and proven parts have been sent by Coreco S.A.
- PAYMENT CONDITIONS**
Until the granting of credit to a customer, all transactions will be paid by advance payment. If the invoices are not paid within the agreed deadlines, the customer will be responsible for the return and/or delay costs.
- SHIPPING OF SPARE PARTS**
All spare parts will be sent postage due.
- RESERVATION OF DOMAIN**
The merchandise is owned and controlled by Coreco S.A. until the total payment of the same by the client.
- LITIGATION**
In this case, the Courts of Lucena (Córdoba) will be competent.
- INFORMATION**
Coreco S.A. reserves the right to introduce, without prior notice, the modifications it deems necessary, without prejudice to the main characteristics of the products.

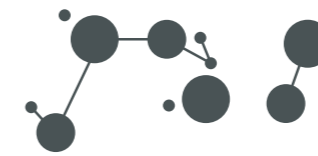

1

RECINTOS MODULARES SERIE RFM
 RFM MOLULAR COLDROOMS
 pag. 12 - 41



2

RECINTOS RFM CON PUERTAS DE CRISTAL
 RFM COLD-ROOMS WITH GLASS DOOR
 pag. 42 - 49



3

ARMARIOS DESMONTABLES SERIE AFD
 AFD MODULAR REACH-IN
 pag. 50 - 57



4

ARMARIOS AFD CON PUERTAS DE CRISTAL
 AFD REACH-IN WITH GLASS DOOR
 pag. 58 - 63



RECINTOS MODULARES SERIE RFM-S
 RFM-S MOLULAR COLDROOMS
 pag. 64 - 93



5



CORTINAS DE LAMAS
 PVC STRIP CURTAINS
 pag. 94 - 97

6



ESTANTERIAS
 SHELVING
 pag. 98 - 119

7



EQUIPOS FRIGORÍFICOS
 COOLIGF UNITS
 pag. 120 - 149

8

Serie RFM

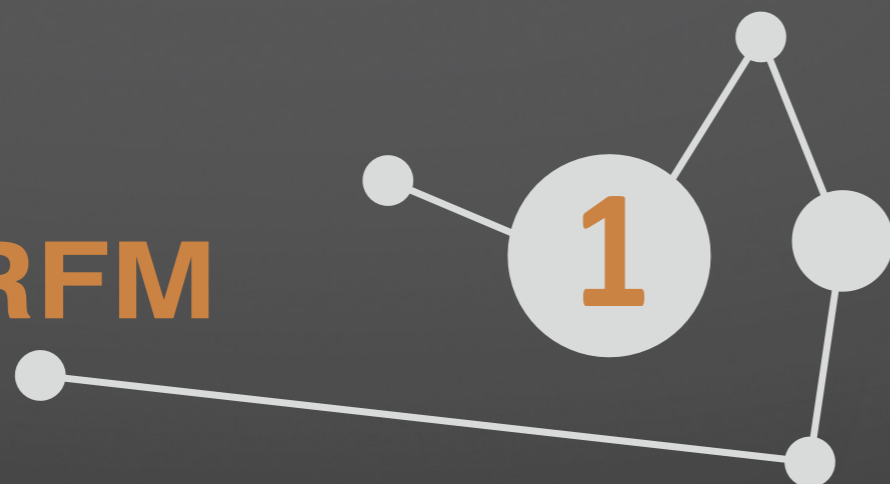

RECINTOS FRIGORÍFICOS MODULARES
MODULAR COLD ROOMS



CORECO

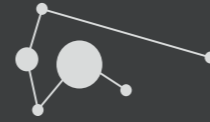

CORECO le presenta ofrecela gama de Recintos Frigoríficos Modulares, **RFM**

En nuestras instalaciones CORECO Centro 2, hemos desarrollado recintos frigoríficos modulare desde la concepción del producto, pasando por el diseño, fabricación, embalaje y comercialización... hemos dedicado la máxima atención y esfuerzo, sobre todo a los pequeños detalles.

En nuestra fabricación empleamos maquinaria sofisticada controladas por computadora y personal bien cualificado. El resultado es un recinto frigorífico con personalidad propia y adaptado al mercado actual.

CORECO presents the Modular Cold Rooms range RFM. We have developed modular cold rooms in our CORECO Centro 2 facilities, from product conception, through design, manufacturing, packaging and marketing ... we have devoted the utmost attention and effort, especially to small details.

We employ sophisticated computer controlled machinery and well-trained personnel in our manufacturing. The result is a cold room with own personality, dapted and ready to be competitive in the current market.

Mecanismo de ganchos excéntricos de doble efecto (gira y recoge)

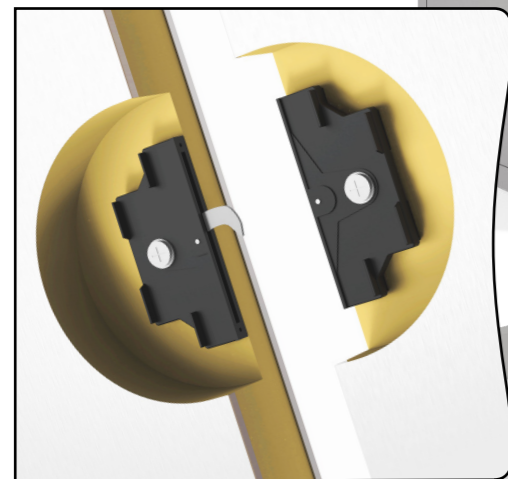

Double effect eccentric hooks mechanism (turns and locks)



Características técnicas y constructivas sujetas a variación sin previo aviso.

We reserve the right to change specifications without prior notice.

SECCIÓN Y ALTURAS. / HEIGHTS AND SECTIONS.

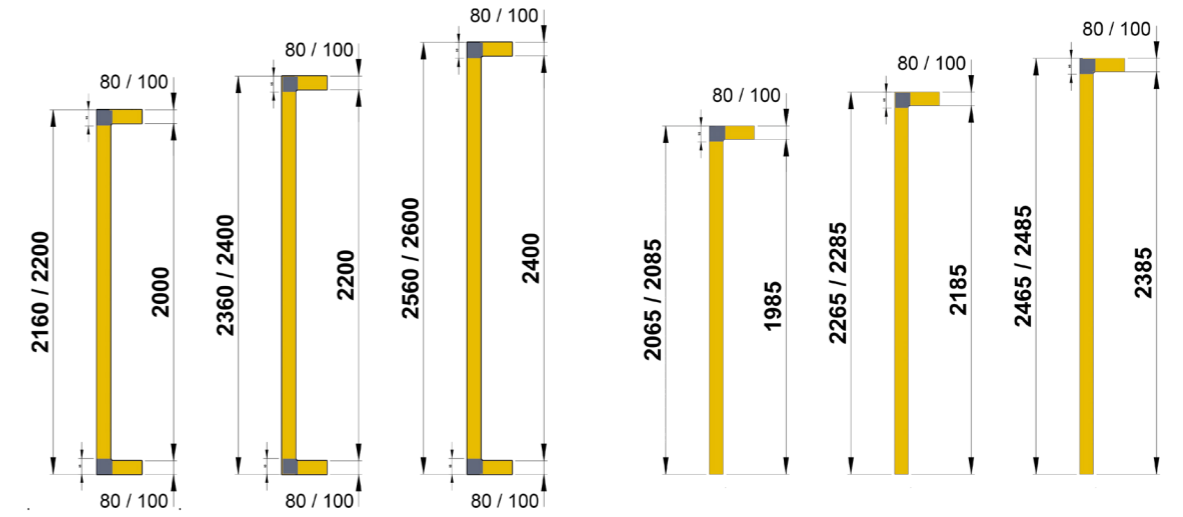

CON suelo panel
WITH floor panel

SIN suelo panel
WITHOUT floor panel

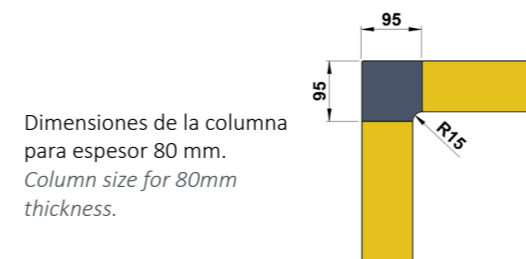

Dimensiones de la columna para espesor 80 mm.
Column size for 80mm thickness.

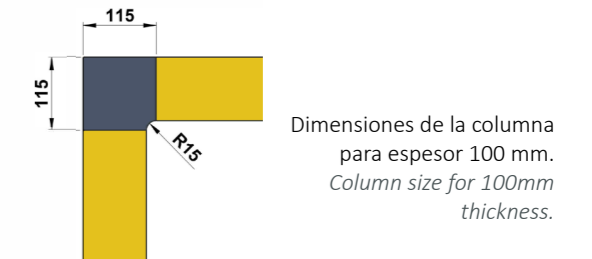

Dimensiones de la columna para espesor 100mm.
Column size for 100mm thickness.

ESPACIOS NECESARIOS PARA UNA CORRECTA INSTALACIÓN.

Recomendamos una adecuada nivelación del suelo donde vaya a ser instalado el recinto frigorífico. Prever que el lugar de ubicación permite el acceso del panel de mayor dimensión.

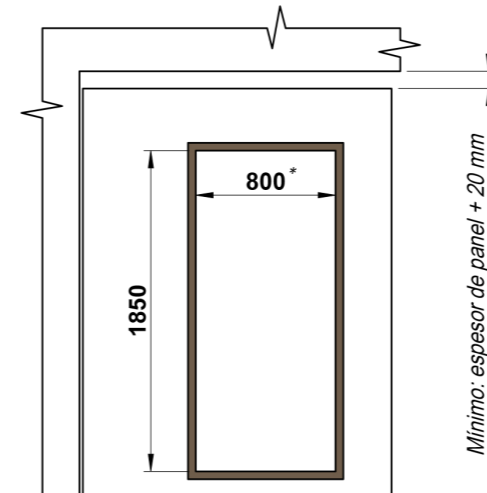

*Bajo pedido, 600, 700, 900 y 1000
*On demmand 600, 700, 900 and 1000

Para poder realizar un montaje correcto es necesario dejar entre el techo del local y el techo del recinto al menos el espesor del panel + 20 mm.

For correct assembly, leave at least the thickness of a panel + 20mm between the roof of the premises and the roof of the room.

Características técnicas y constructivas sujetas a variación sin previo aviso.

SPACE NEEDED FOR CORRECT INSTALLATION.

We recommend an adequate leveling of the floor where the cold room will be installed.. Ensure that the location allows access with the largest panel.

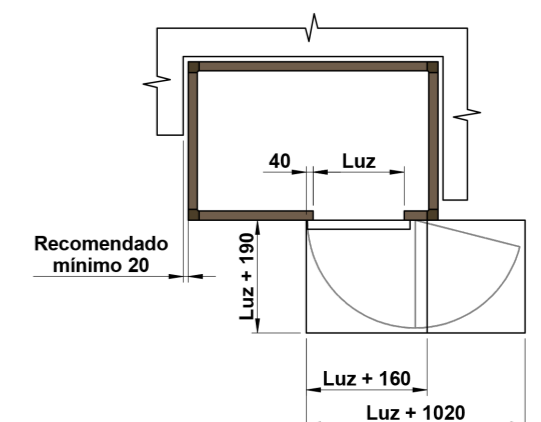

Dimensiones necesarias para una apertura de la puerta a 90° y 180°

Measurements needed to open the door at 90° and 180°

We reserve the right to change specifications without prior notice.

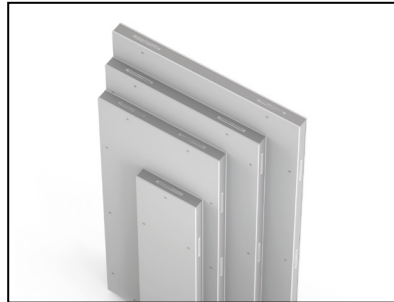
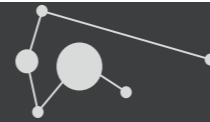

Paneles:

- Espesor de 80 y 100 mm.
- Modularidad 400, 800, 1000 y 1200 mm facilita la adaptabilidad a las dimensiones de su recinto.
- Longitud máxima del panel 3000 mm.

Panels:

- 80 and 100mm thickness.
- 400, 800, 1000 and 1200mm modules to suit the size of your room.
- Maximum panel length 3000mm.



Revestimiento:

- Revestimiento estándar en acero galvanizado prelacado poliéster, con film de protección.
- Color blanco pirineo.
- Calidad alimentaria.

Cladding:

- Galvanized steel cladding pre-lacquered with polyester, with a protective film, as standard.
- Colour white, "blanco pirineo".
- Food grade.

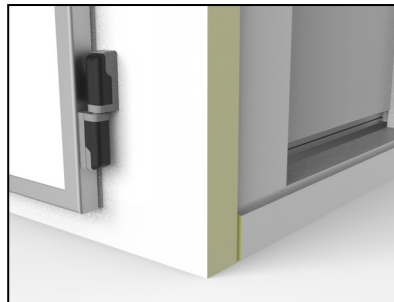

Aislamiento:

- Espuma rígida de poliuretano, libre de CFC e inyectado a alta presión
- Densidad 45 Kg. / m²
- Coeficiente de conductividad térmica 0.022W/mK a 10°C. (Sin envejecimiento)

Insulation:

- Rigid polyurethane foam, CFC-free, injected at high pressure.
- Density 45kg/m².
- Thermal conductivity coefficient 0.022W/mK at 10°C. (Without ageing).



Terminación del Panel de Suelo:

- Suelo reforzado: Idóneo para el tránsito de personas y carretillas manuales. Acabado interior de contrachapado de abedul y resina fenólica antideslizante.
- Suelo de acero inoxidable antideslizante aisi 304 18/8.
- Suelo de chapa lacada blanca igual que el resto de paneles.

Floor Panel Finish:

- Reinforced flooring: Ideal for the transit of people and manual trucks. Birch plywood interior finish with non-slip phenolic resin.
- Non-slip stainless steel flooring AISI 304 18/8.
- Metal flooring lacquered white the same as the rest of the panels.



Columnas verticales y horizontales:

- Columnas perimetrales con innovador perfil sanitario de labio flexible
- Unión perfecta de gran calidad.
- Revestimiento exterior en el mismo material usado en los paneles
- Línea estética regular en toda la cámara.
- Conjunto inyectado con poliuretano

Vertical and horizontal columns:

- Perimeter columns with innovative sanitary flexible lip seal.
- High quality perfect joints.
- Exterior cladding in the same material as the panels.
- Regular aesthetic line throughout the room.
- Everything is injected with polyurethane.



Sistema de Unión:

- Mecanismo de ganchos excéntricos de alta resistencia y doble efecto (gira y recoge), colocados en carcasas de ABS. El conjunto está pensado para trabajar de dos maneras: engancha y puede ser enganchado.

Connecting System:

- High resistance and double effect eccentric hooks mechanism (turns and locks), installed in ABS housings. The combination is designed to work in two ways: it engages and can be hooked.

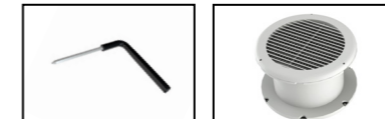
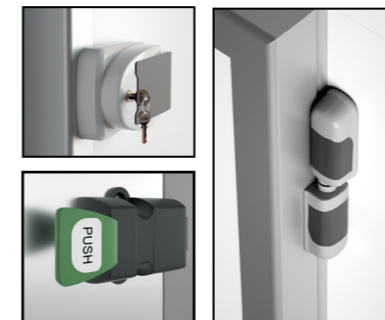
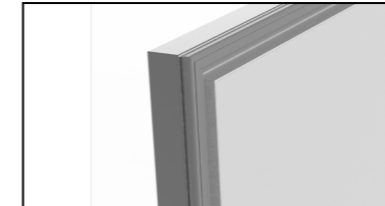
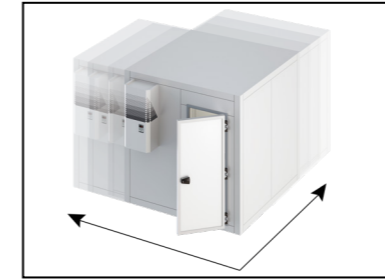

Modularidad:

- Dos espesores: 80 y 100 mm.
- Modulación 200 mm.
- Tres alturas exteriores diferentes

Modularity:

- Two thicknesses: 80 and 100mm.
- Modulation 200mm.
- Three different external heights.

Puerta:

- Espesor 80 mm
- Marco perimetral exterior de aluminio anodizado anticorrosión.
- Burlete de estanqueidad.
- Hueco de luz 1850 x 800 mm.
- Sólo en panel 100 mm: resistencia eléctrica antiescarcha colocada en el marco del panel de puerta.
- Tanto el panel puerta como la puerta están inyectados en su interior con el mismo aislamiento del resto de paneles.
- Bisagras con regulación y pasador inoxidable.
- Cierre con llave y con un punto de presión.

Door:

- 80 mm thickness
- Exterior perimeter frame made of anodized anti-corrosion aluminium.
- Sealing gasket.
- A light shaft of 1850mm and 800mm.
- Only for 100 mm panel: frost prevention electric resistance placed on door panel frame.
- Both the door panel and the door are injected with the same insulation as the rest of the panels.
- Adjustable hinges with stainless steel pin.
- Locks with key and pressure point.

Accesorios incluidos:

- Válvula compensadora de presiones para todas las cámaras de espesor 100
- Caja de conexiones y resistencia marco sólo en puerta para panel 100
- Perfil sanitario con labio flexible, incorporado en todos los perfiles COLUMNA
- Perfil "U" de montaje para cámaras sin panel de suelo
- Luz interior
- Llave hexagonal con mango para montaje de las fijaciones de paneles

Parts included:

- Pressure compensation valve for all chambers of thickness 100
- Junction box and resistance frame only in door for panel 100
- Incorporated sanitary profile with flexible lip, in all COLUMNS
- Mounting "U" profile for cameras without floor panel
- Interior light
- Hexagonal wrench with handle for mounting panel fixings

OPCIONES bajo pedido

- Otras calidades y colores para el revestimiento del panel tanto para el exterior como en el interior
- Suelo con acabado interior en acero inoxidable antideslizante
- Suelo con acabado blanco pirineo, igual al resto de paneles
- Equipo frigorífico
- Estanterías de aluminio y polietileno de fabricación propia.
- Resistencia eléctrica en cámaras de espesor 80 mm.
- Puerta apertura a mano izquierda (estándar abre a mano derecha)
- Puerta corredera 1850 x 800 mm
- Huecos de puerta, abatible o corredera, con anchos especiales: 600, 700, 900 y 1000 mm
- Hacha de bombero
- Soporte hacha
- Alarma hombre atrapado
- Rampa para puerta abatible o corredera
- Rastreles para separación entre el panel inferior y el suelo

OPTIONS on request

- Other qualities and colors for the panel covering both for the exterior and interior
- Floor with non-slip stainless steel interior finish
- Floor with a white pyrenean finish, the same as the other panels
- Refrigeration equipment
- Self-made aluminum and polyethylene shelves.
- Electrical resistance in chambers of thickness 80 mm.
- Door open on the left (standard opens on the right)
- Sliding door 1850 x 800 mm
- Door openings, pivoting or sliding, with special widths: 600, 700, 900 and 1000 mm
- Fire ax
- Ax support
- Trapped man alarm
- Ramp for swing or sliding door
- Tracks for separation between bottom panel and base floor

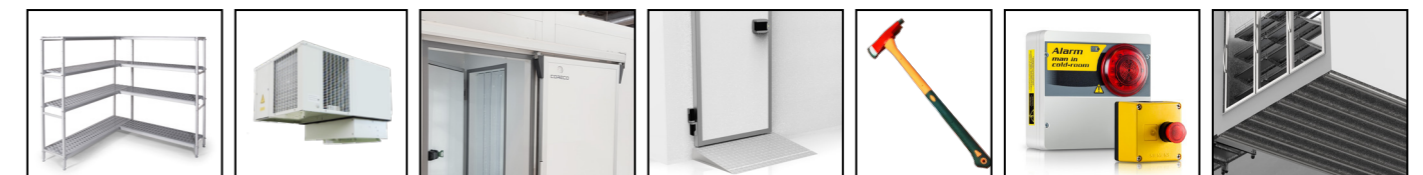

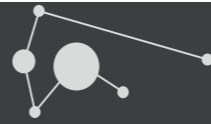

Información completa en la sección 7 de este catálogo

All data about shelving, in the section 7 of this catalogue

ESTANTERÍAS MODULARES realizadas con una estructura de aluminio anodizado y parrillas de polietileno, aptas para el uso con productos alimentarios.

Con nuestras Estanterías y sus múltiples combinaciones conseguirá una óptima eficiencia en la organización y almacenaje. Los materiales empleados en su construcción, la hacen especialmente adecuadas para su uso en cámaras frigoríficas.

MODULAR SHELVING UNITS made with an anodized aluminium structure and polyethylene wire shelves, suitable for food storage. Our Shelving Units and their multiple combinations will enable you to efficiently store and organise your products. The materials used to build the units make them especially durable for use in cold room.

Características técnicas:

- Especialmente diseñadas para uso alimentario.
- Estructura de aluminio anodizado que proporciona gran rigidez al conjunto.
- Parrillas fabricadas en polietileno calidad alimentaria.
- Tornillería utilizada en su construcción de acero inoxidable.
- Máxima modularidad que la hace adaptable a todos los espacios.
- Dos Fondos de estantes, 400 ó 500 mm.
- Tres alturas, con estantes regulables cada 150 mm.
- También recomendadas para el uso en cámaras frigoríficas, tanto para temperaturas positivas como negativas.
- No se necesita ningún tipo de herramientas para su montaje.

Technical specifications:

- Specifically designed for use with food products.
- Strong anodized aluminium structure.
- Wire shelves are made of food grade polyethylene.
- Assembled using stainless steel screws.
- Maximum modularity making the units adaptable to all spaces.
- Two shelf depths, 400 or 500mm.
- Three heights, with adjustable shelves every 150mm.
- Also recommended for use in cold rooms, for both plus and minus temperatures.
- No tools are needed for assembly.



ALTURA 1370 mm.
FONDO 400 Ó 500 mm.
3 ó 4 NIVELES

HEIGHT 1370mm
DEPTH 400 or 500mm
3 or 4 SHELVES

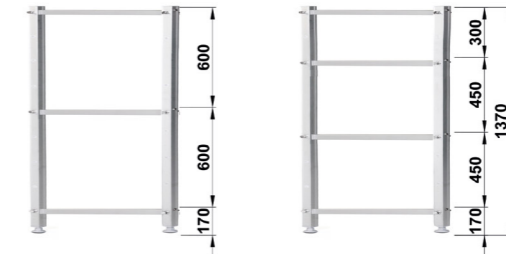

ALTURA 1670 mm.
FONDO 400 Ó 500 mm.
3 ó 4 NIVELES

HEIGHT 1670mm
DEPTH 400 or 500mm
3 or 4 SHELVES

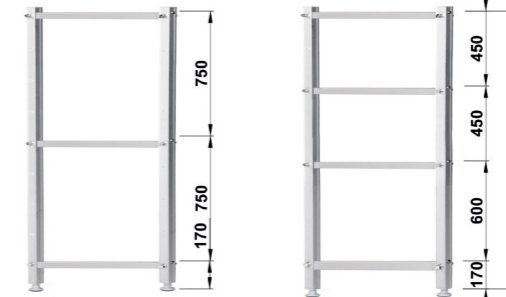

Separación mínima entre estantes 150 mm

150 mm min. distance between shelves

ALTURA 1970 mm.
FONDO 400 Ó 500 mm.
3,4 ó 5 NIVELES

HEIGHT 1970mm
DEPTH 400 or 500mm
3, 4 or 5 SHELVES

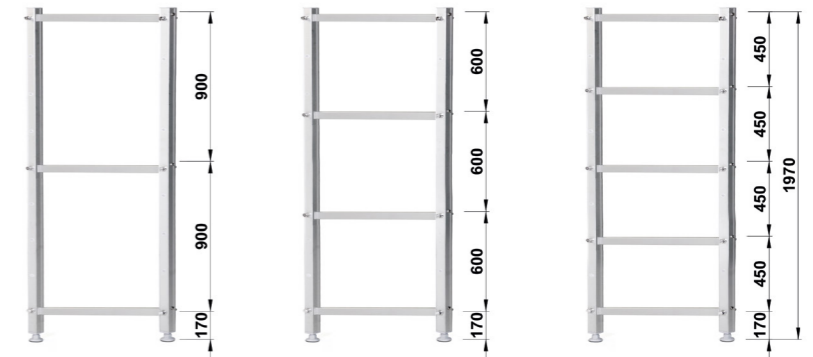

LONGITUD DE ESTANTERÍAS LINEALES INDIVIDUALES. COMPOSICIÓN DE ESTANTES.

LENGTH OF INDIVIDUAL LINEAR SHELVING UNITS. SHELF ASSEMBLY.

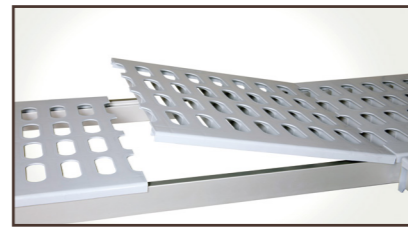
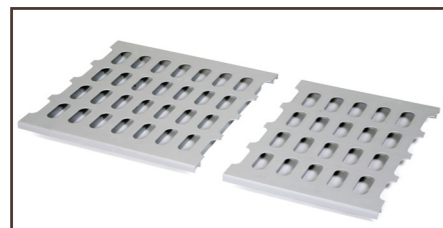
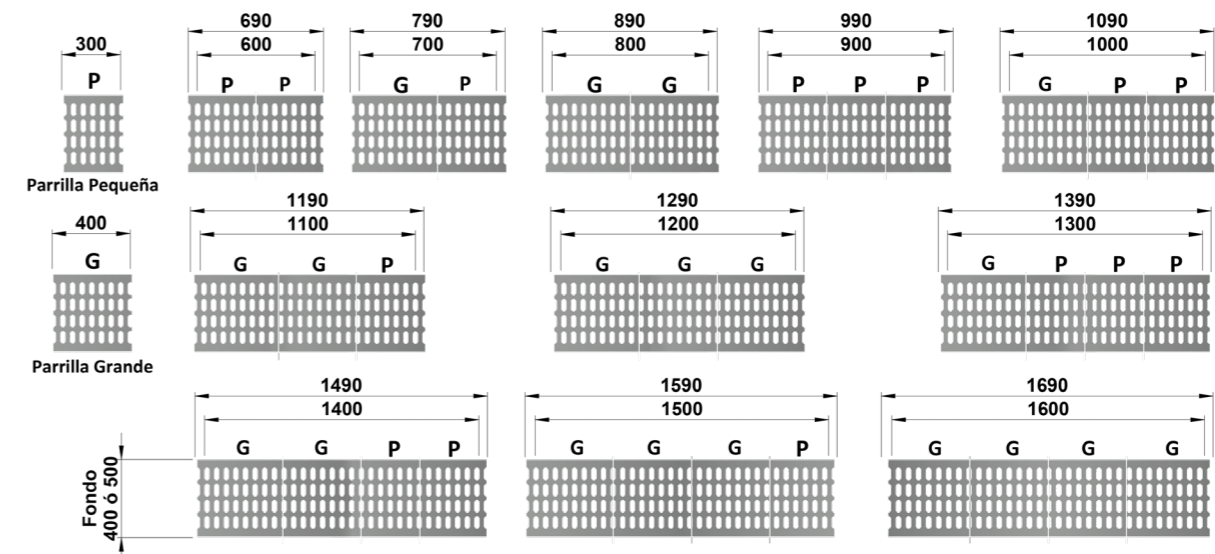

Parrillas: Fácil montaje y desmontaje. Máxima higiene. Las parrillas se pueden lavar en lavavajillas convencional.
Wire shelves: Easy assembly and disassembly. Maximum hygiene. Wire shelves can be washed in a conventional dishwasher.



Soportos ángulo: Posibilitan el montaje en ángulo de la estantería otorgándole gran modularidad.
Angle brackets: Make it possible to mount shelving units at an angle providing a high amount of flexibility.



Montaje: Fácil montaje. Todas las piezas encajan a la perfección sin necesidad de herramientas.
Assembly: Easy assembly. All pieces fit together perfectly without the need for tools.

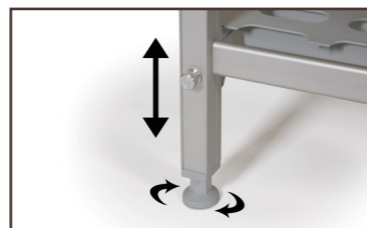

Pies: Con regulación en altura para salvar posibles desniveles del suelo.
Feet: Adjustable feet for uneven floors.

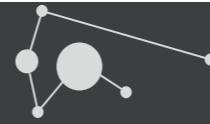

En las tablas de la siguiente página, se identifica el modelo del recinto correspondiente con el espesor de aislamiento (80 / 100 mm) y las medias en planta (largo y fondo).

Este código te dirigirá a la página correspondiente, donde en base a la altura y tipo de suelo, podrá determinar código y precio del recinto.

También se identifica en la tabla particular para cada configuración, el volumen interior de la cámara, lo cual le ayudará a seleccionar el equipo frigorífico apropiado.

The tables on the following page show the corresponding room model with an insulation thickness of 80/100mm and its floor measurements (length and width).

Use the code to locate the corresponding page, where based on the height and type of floor, you can determine the code and price of the room.

For each room layout the table also gives its interior volume, to help you to select the appropriate refrigerator equipment.

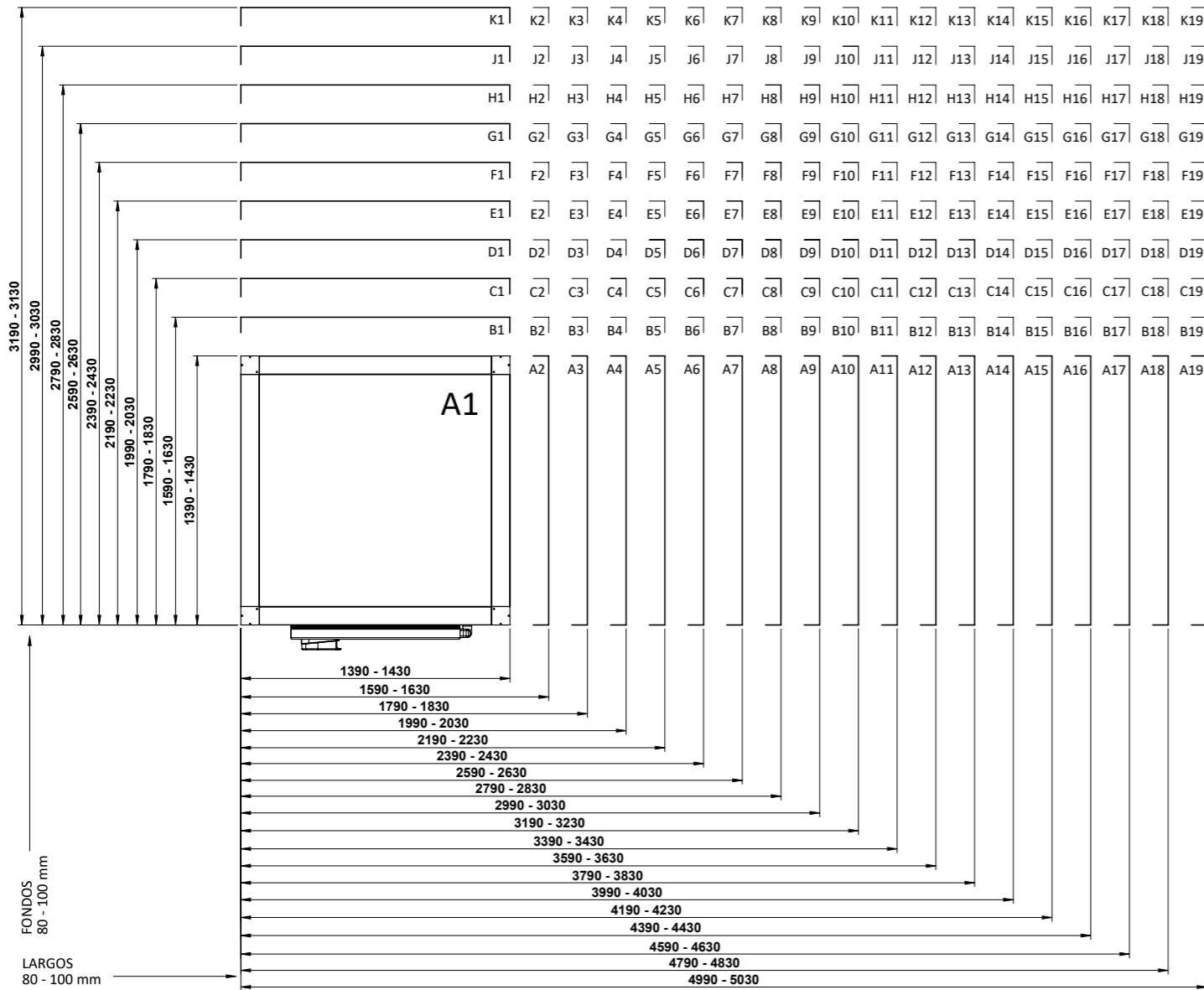

*Ejemplo de elección
D4, 80 mm.: Fondo 1990 mm. Largo 1990 mm.

*Example choices
D4, 80mm.: Depth 1990mm. Length 1990mm.

80		Largo - Length (L) mm																			
		1390	1590	1790	1990	2190	2390	2590	2790	2990	3190	3390	3590	3790	3990	4190	4390	4590	4790	4990	PAG
Fondo - Depth mm	1390	A1	A2	A3	A4	A5	A6	A7	A8	A9	A10	A11	A12	A13	A14	A15	A16	A17	A18	A19	18
	1590	B1	B2	B3	B4	B5	B6	B7	B8	B9	B10	B11	B12	B13	B14	B15	B16	B17	B18	B19	20
	1790	C1	C2	C3	C4	C5	C6	C7	C8	C9	C10	C11	C12	C13	C14	C15	C16	C17	C18	C19	22
	1990	D1	D2	D3	D4	D5	D6	D7	D8	D9	D10	D11	D12	D13	D14	D15	D16	D17	D18	D19	24
	2190	E1	E2	E3	E4	E5	E6	E7	E8	E9	E10	E11	E12	E13	E14	E15	E16	E17	E18	E19	26
	2390	F1	F2	F3	F4	F5	F6	F7	F8	F9	F10	F11	F12	F13	F14	F15	F16	F17	F18	F19	28
	2590	G1	G2	G3	G4	G5	G6	G7	G8	G9	G10	G11	G12	G13	G14	G15	G16	G17	G18	G19	30
	2790	H1	H2	H3	H4	H5	H6	H7	H8	H9	H10	H11	H12	H13	H14	H15	H16	H17	H18	H19	32
	2990	J1	J2	J3	J4	J5	J6	J7	J8	J9	J10	J11	J12	J13	J14	J15	J16	J17	J18	J19	34
	3190	K1	K2	K3	K4	K5	K6	K7	K8	K9	K10	K11	K12	K13	K14	K15	K16	K17	K18	K19	36

100		Largo - Length (L) mm																			
		1430	1630	1830	2030	2230	2430	2630	2830	3030	3230	3430	3630	3830	4030	4230	4430	4630	4830	5030	PAG
Fondo - Depth mm	1430	A1	A2	A3	A4	A5	A6	A7	A8	A9	A10	A11	A12	A13	A14	A15	A16	A17	A18	A19	19
	1630	B1	B2	B3	B4	B5	B6	B7	B8	B9	B10	B11	B12	B13	B14	B15	B16	B17	B18	B19	21
	1830	C1	C2	C3	C4	C5	C6	C7	C8	C9	C10	C11	C12	C13	C14	C15	C16	C17	C18	C19	23
	2030	D1	D2	D3	D4	D5	D6	D7	D8	D9	D10	D11	D12	D13	D14	D15	D16	D17	D18	D19	25
	2230	E1	E2	E3	E4	E5	E6	E7	E8	E9	E10	E11	E12	E13	E14	E15	E16	E17	E18	E19	27
	2430	F1	F2	F3	F4	F5	F6	F7	F8	F9	F10	F11	F12	F13	F14	F15	F16	F17	F18	F19	29
	2630	G1	G2	G3	G4	G5	G6	G7	G8	G9	G10	G11	G12	G13	G14	G15	G16	G17	G18	G19	31
	2830	H1	H2	H3	H4	H5	H6	H7	H8	H9	H10	H11	H12	H13	H14	H15	H16	H17	H18	H19	33
	3030	J1	J2	J3	J4	J5	J6	J7	J8	J9	J10	J11	J12	J13	J14	J15	J16	J17	J18	J19	35
	3230	K1	K2	K3	K4	K5	K6	K7	K8	K9	K10	K11	K12	K13	K14	K15	K16	K17	K18	K19	37

A la hora de elegir su cámara, tenga en cuenta que la ubicación de la puerta estará siempre colocada en el largo.
At time of choosing your Cold Room, keep in mind that the location of the door will always be placed on the length part of the Cold Room.

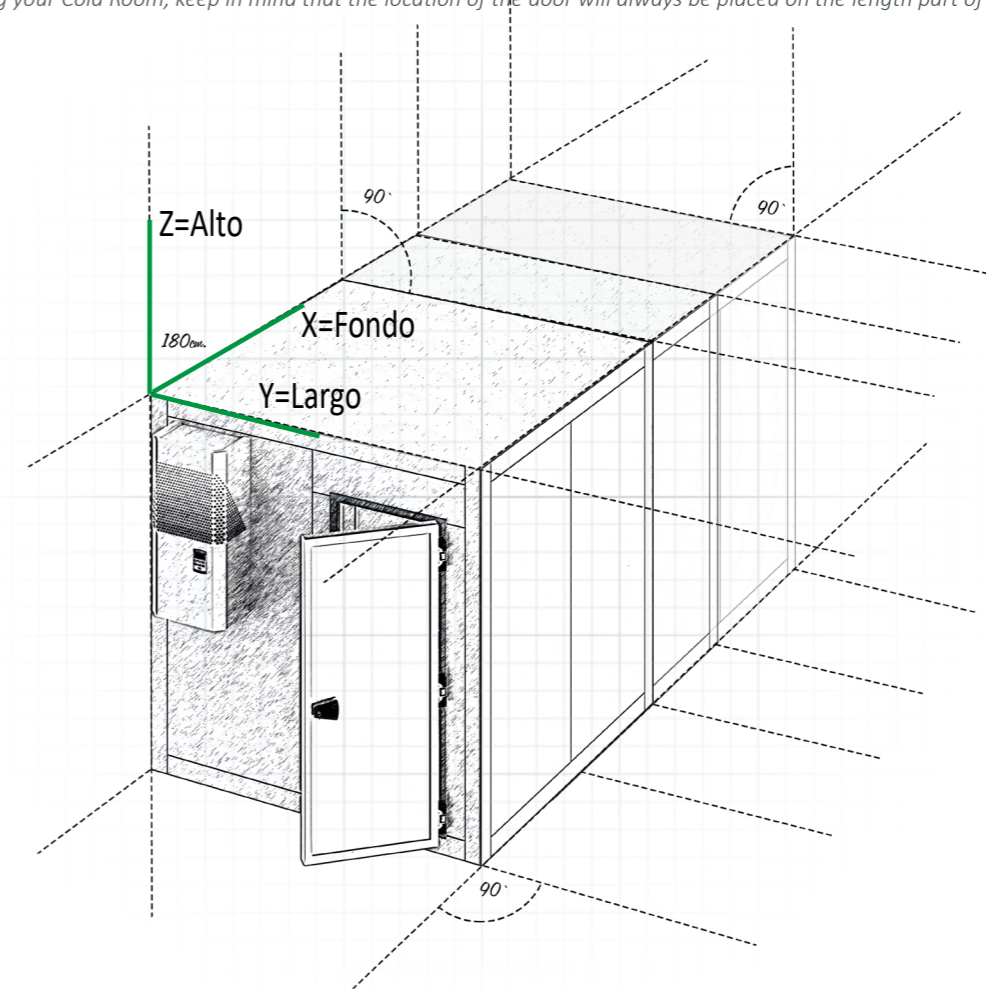



80	Largo - Length (L)																			
	1390	1590	1790	1990	2190	2390	2590	2790	2990	3190	3390	3590	3790	3990	4190	4390	4590	4790	4990	
Fondo - Depth mm	1390	A1	A2	A3	A4	A5	A6	A7	A8	A9	A10	A11	A12	A13	A14	A15	A16	A17	A18	A19

80	CON suelo - WITH floor panel					SIN suelo - WITHOUT floor panel				
	COD	m²	L	H	€	COD	m²	L	H	€
A1	A1R-139139AC	3.03	1390	2160	3.211 €	A1R-139139AS	3	1390	2065	2.818 €
	A1R-139139BC	3.33	1390	2360	3.366 €	A1R-139139BS	3.31	1390	2265	2.967 €
	A1R-139139CC	3.63	1390	2560	3.513 €	A1R-139139CS	3.61	1390	2465	3.121 €
A2	A2R-139159AC	3.52	1590	2160	3.430 €	A2R-139159AS	3.49	1590	2065	2.973 €
	A2R-139159BC	3.87	1590	2360	3.591 €	A2R-139159BS	3.84	1590	2265	3.135 €
	A2R-139159CC	4.22	1590	2560	3.753 €	A2R-139159CS	4.19	1590	2465	3.295 €
A3	A3R-139179AC	4.01	1790	2160	3.650 €	A3R-139179AS	3.98	1790	2065	3.127 €
	A3R-139179BC	4.41	1790	2360	3.824 €	A3R-139179BS	4.38	1790	2265	3.301 €
	A3R-139179CC	4.81	1790	2560	3.989 €	A3R-139179CS	4.78	1790	2465	3.469 €
A4	A4R-139199AC	4.5	1990	2160	3.868 €	A4R-139199AS	4.47	1990	2065	3.288 €
	A4R-139199BC	4.95	1990	2360	4.049 €	A4R-139199BS	4.92	1990	2265	3.469 €
	A4R-139199CC	5.4	1990	2560	4.229 €	A4R-139199CS	5.37	1990	2465	3.650 €
A5	A5R-139219AC	4.99	2190	2160	4.088 €	A5R-139219AS	4.96	2190	2065	3.443 €
	A5R-139219BC	5.49	2190	2360	4.280 €	A5R-139219BS	5.46	2190	2265	3.630 €
	A5R-139219CC	5.99	2190	2560	4.467 €	A5R-139219CS	5.96	2190	2465	3.824 €
A6	A6R-139239AC	5.49	2390	2160	4.305 €	A6R-139239AS	5.44	2390	2065	3.597 €
	A6R-139239BC	6.03	2390	2360	4.504 €	A6R-139239BS	5.99	2390	2265	3.797 €
	A6R-139239CC	6.58	2390	2560	4.704 €	A6R-139239CS	6.54	2390	2465	3.997 €
A7	A7R-139259AC	5.98	2590	2160	4.517 €	A7R-139259AS	5.93	2590	2065	3.753 €
	A7R-139259BC	6.58	2590	2360	4.731 €	A7R-139259BS	6.53	2590	2265	3.965 €
	A7R-139259CC	7.17	2590	2560	4.943 €	A7R-139259CS	7.13	2590	2465	4.177 €
A8	A8R-139279AC	6.47	2790	2160	4.738 €	A8R-139279AS	6.42	2790	2065	3.908 €
	A8R-139279BC	7.12	2790	2360	4.962 €	A8R-139279BS	7.07	2790	2265	4.132 €
	A8R-139279CC	7.76	2790	2560	5.181 €	A8R-139279CS	7.72	2790	2465	4.351 €
A9	A9R-139299AC	6.96	2990	2160	4.956 €	A9R-139299AS	6.91	2990	2065	4.061 €
	A9R-139299BC	7.66	2990	2360	5.188 €	A9R-139299BS	7.61	2990	2265	4.295 €
	A9R-139299CC	8.35	2990	2560	5.419 €	A9R-139299CS	8.3	2990	2465	4.531 €
A10	A10R-139319AC	7.45	3190	2160	5.174 €	A10R-139319AS	7.4	3190	2065	4.216 €
	A10R-139319BC	8.2	3190	2360	5.419 €	A10R-139319BS	8.14	3190	2265	4.460 €
	A10R-139319CC	8.94	3190	2560	5.663 €	A10R-139319CS	8.89	3190	2465	4.704 €
A11	A11R-139339AC	7.95	3390	2160	5.393 €	A11R-139339AS	7.89	3390	2065	4.370 €
	A11R-139339BC	8.74	3390	2360	5.650 €	A11R-139339BS	8.68	3390	2265	4.627 €
	A11R-139339CC	9.53	3390	2560	5.908 €	A11R-139339CS	9.48	3390	2465	4.879 €
A12	A12R-139359AC	8.44	3590	2160	5.612 €	A12R-139359AS	8.37	3590	2065	4.526 €
	A12R-139359BC	9.28	3590	2360	5.883 €	A12R-139359BS	9.22	3590	2265	4.796 €
	A12R-139359CC	10.13	3590	2560	6.154 €	A12R-139359CS	10.06	3590	2465	5.052 €
A13	A13R-139379AC	8.93	3790	2160	5.830 €	A13R-139379AS	8.86	3790	2065	4.680 €
	A13R-139379BC	9.82	3790	2360	6.115 €	A13R-139379BS	9.76	3790	2265	4.962 €
	A13R-139379CC	10.72	3790	2560	6.399 €	A13R-139379CS	10.65	3790	2465	5.225 €
A14	A14R-139399AC	9.42	3990	2160	6.049 €	A14R-139399AS	9.35	3990	2065	4.834 €
	A14R-139399BC	10.36	3990	2360	6.346 €	A14R-139399BS	10.29	3990	2265	5.130 €
	A14R-139399CC	11.31	3990	2560	6.641 €	A14R-139399CS	11.24	3990	2465	5.400 €
A15	A15R-139419AC	9.91	4190	2160	6.270 €	A15R-139419AS	9.84	4190	2065	4.988 €
	A15R-139419BC	10.91	4190	2360	6.578 €	A15R-139419BS	10.83	4190	2265	5.297 €
	A15R-139419CC	11.9	4190	2560	6.887 €	A15R-139419CS	11.82	4190	2465	5.573 €
A16	A16R-139439AC	10.41	4390	2160	6.489 €	A16R-139439AS	10.33	4390	2065	5.141 €
	A16R-139439BC	11.45	4390	2360	6.809 €	A16R-139439BS	11.37	4390	2265	5.465 €
	A16R-139439CC	12.49	4390	2560	7.132 €	A16R-139439CS	12.41	4390	2465	5.747 €
A17	A17R-139459AC	10.9	4590	2160	6.707 €	A17R-139459AS	10.82	4590	2065	5.297 €
	A17R-139459BC	11.99	4590	2360	7.043 €	A17R-139459BS	11.91	4590	2265	5.632 €
	A17R-139459CC	13.08	4590	2560	7.376 €	A17R-139459CS	13	4590	2465	5.921 €
A18	A18R-139479AC	11.39	4790	2160	6.927 €	A18R-139479AS	11.3	4790	2065	5.451 €
	A18R-139479BC	12.53	4790	2360	7.274 €	A18R-139479BS	12.44	4790	2265	5.800 €
	A18R-139479CC	13.67	4790	2560	7.620 €	A18R-139479CS	13.58	4790	2465	6.097 €
A19	A19R-139499AC	11.88	4990	2160	7.145 €	A19R-139499AS	11.79	4990	2065	5.606 €
	A19R-139499BC	13.07	4990	2360	7.504 €	A19R-139499BS	12.98	4990	2265	5.966 €
	A19R-139499CC	14.26	4990	2560	7.866 €	A19R-139499CS	14.17	4990	2465	6.270 €

100	Largo - Length (L)																			
	1430	1630	1830	2030	2230	2430	2630	2830	3030	3230	3430	3630	3830	4030	4230	4430	4630	4830	5030	
Fondo - Depth mm	1430	A1	A2	A3	A4	A5	A6	A7	A8	A9	A10	A11	A12	A13	A14	A15	A16	A17	A18	A19

100	CON suelo - WITH floor panel					SIN suelo - WITHOUT floor panel				
	COD	m²	L	H	€	COD	m²	L	H	€
A1	A1C-143143AC	3.03	1430	2200	3.522 €	A1C-143143AS	3	1430	2085	3.127 €
	A1C-143143BC	3.33	1430	2400	3.681 €	A1C-143143BS	3.31	1430	2285	3.282 €
	A1C-143143CC	3.63	1430	2600	3.842 €	A1C-143143CS	3.61	1430	2485	3.443 €
A2	A2C-143163AC	3.52	1630	2200	3.753 €	A2C-143163AS	3.49	1630	2085	3.288 €
	A2C-143163BC	3.87	1630	2400	3.919 €	A2C-143163BS	3.84	1630	2285	3.455 €
	A2C-143163CC	4.22	1630	2600	4.094 €	A2C-143163CS	4.19	1630	2485	3.630 €
A3	A3C-143183AC	4.01	1830	2200	3.977 €	A3C-143183AS	3.98	1830	2085	3.450 €
	A3C-143183BC	4.41	1830	2400	4.157 €	A3C-143183BS	4.38	1830	2285	3.636 €
	A3C-143183CC	4.81	1830	2600	4.339 €	A3C-143183CS	4.78	1830	2485	3.816 €
A4	A4C-143203AC	4.5	2030	2200	4.201 €	A4C-143203AS	4.47	2030	2085	3.617 €
	A4C-143203BC	4.95	2030	2400	4.396 €	A4C-143203BS	4.92	2030	2285	3.809 €
	A4C-143203CC	5.4	2030	2600	4.588 €	A4C-143203CS	5.37	2030	2485	4.003 €
A5	A5C-143223AC	4.99	2230	2200	4.428 €	A5C-143223AS	4.96	2230	2085	3.779 €
	A5C-143223BC	5.49	2230	2400	4.633 €	A5C-143223BS	5.46	2230	2285	3.984 €
	A5C-143223CC	5.99	2230	2600	4.840 €	A5C-143223CS	5.96	2230	2485	4.190 €
A6	A6C-143243AC	5.49	2430	2200	4.659 €	A6C-143243AS	5.44	2430	2085	3.945 €
	A6C-143243BC	6.03	2430	2400	4.871 €	A6C-143243BS	5.99	2430	2285	4.157 €
	A6C-143243CC	6.58	2430	2600	5.085 €	A6C-143243CS	6.54	2430	2485	4.370 €
A7	A7C-143263AC	5.98	2630	2200	4.885 €	A7C-143263AS	5.93	2630	2085	4.106 €
	A7C-143263BC	6.58	2630	2400	5.112 €	A7C-143263BS	6.53	2630	2285	4.331 €
	A7C-143263CC	7.17	2630	2600	5.335 €	A7C-143263CS	7.13	2630	2485	4.556 €
A8	A8C-143283AC	6.47	2830	2200	5.112 €	A8C-143283AS	6.42	2830	2085	4.273 €
	A8C-143283BC	7.12	2830	2400	5.348 €	A8C-143283BS	7.07	2830	2285	4.504 €
	A8C-143283CC	7.76	2830	2600	5.579 €	A8C-143283CS	7.72	2830	2485	4.743 €
A9	A9C-143303AC	6.96	3030	2200	5.335 €	A9C-143303AS	6.91	3030	2085	4.433 €
	A9C-143303BC	7.66	3030	2400	5.588 €	A9C-143303BS	7.61	3030	2285	4.687 €
	A9C-143303CC	8.35	3030	2600	5.830 €	A9C-143303CS	8.3	3030	2485	4.929 €
A10	A10C-143323AC	7.45	3230	2200	5.568 €	A10C-143323AS				

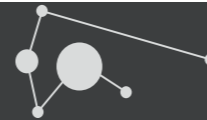

80	Largo - Length (L)																		
	1390	1590	1790	1990	2190	2390	2590	2790	2990	3190	3390	3590	3790	3990	4190	4390	4590	4790	4990
Fondo - Depth mm 1590	B1	B2	B3	B4	B5	B6	B7	B8	B9	B10	B11	B12	B13	B14	B15	B16	B17	B18	B19

80	CON suelo - WITH floor panel					SIN suelo - WITHOUT floor panel				
	COD	m³	L	H	€	COD	m³	L	H	€
B1	B1R-159139AC	4,09	1590	2160	3.430 €	B1R-159139AS	4,06	1590	2065	2.973 €
	B1R-159139BC	4,5	1590	2360	3.591 €	B1R-159139BS	4,47	1590	2265	3.135 €
	B1R-159139CC	4,91	1590	2560	3.753 €	B1R-159139CS	4,88	1590	2465	3.295 €
B2	B2R-159159AC	4,09	1590	2160	3.669 €	B2R-159159AS	4	1590	2065	3.135 €
	B2R-159159BC	4,5	1590	2360	3.837 €	B2R-159159BS	4	1590	2265	3.309 €
	B2R-159159CC	4,91	1590	2560	4.010 €	B2R-159159CS	5	1590	2465	3.474 €
B3	B3R-159179AC	4,66	1790	2160	3.900 €	B3R-159179AS	5	1790	2065	3.295 €
	B3R-159179BC	5,13	1790	2360	4.080 €	B3R-159179BS	5	1790	2265	3.474 €
	B3R-159179CC	5,59	1790	2560	4.261 €	B3R-159179CS	6	1790	2465	3.662 €
B4	B4R-159199AC	5,23	1990	2160	4.132 €	B4R-159199AS	5	1990	2065	3.455 €
	B4R-159199BC	5,76	1990	2360	4.325 €	B4R-159199BS	6	1990	2265	3.650 €
	B4R-159199CC	6,28	1990	2560	4.512 €	B4R-159199CS	6	1990	2465	3.842 €
B5	B5R-159219AC	5,81	2190	2160	4.363 €	B5R-159219AS	6	2190	2065	3.617 €
	B5R-159219BC	6,39	2190	2360	4.564 €	B5R-159219BS	6	2190	2265	3.816 €
	B5R-159219CC	6,97	2190	2560	4.770 €	B5R-159219CS	7	2190	2465	4.023 €
B6	B6R-159239AC	6,38	2390	2160	4.596 €	B6R-159239AS	6	2390	2065	3.779 €
	B6R-159239BC	7,02	2390	2360	4.809 €	B6R-159239BS	7	2390	2265	3.989 €
	B6R-159239CC	7,65	2390	2560	5.020 €	B6R-159239CS	8	2390	2465	4.201 €
B7	B7R-159259AC	6,95	2590	2160	4.827 €	B7R-159259AS	7	2590	2065	3.939 €
	B7R-159259BC	7,64	2590	2360	5.052 €	B7R-159259BS	8	2590	2265	4.157 €
	B7R-159259CC	8,34	2590	2560	5.277 €	B7R-159259CS	8	2590	2465	4.384 €
B8	B8R-159279AC	7,52	2790	2160	5.066 €	B8R-159279AS	7	2790	2065	4.100 €
	B8R-159279BC	8,27	2790	2360	5.297 €	B8R-159279BS	8	2790	2265	4.331 €
	B8R-159279CC	9,03	2790	2560	5.528 €	B8R-159279CS	9	2790	2465	4.564 €
B9	B9R-159299AC	8,09	2990	2160	5.297 €	B9R-159299AS	8	2990	2065	4.261 €
	B9R-159299BC	8,9	2990	2360	5.543 €	B9R-159299BS	9	2990	2265	4.499 €
	B9R-159299CC	9,71	2990	2560	5.780 €	B9R-159299CS	10	2990	2465	4.743 €
B10	B10R-159319AC	8,67	3190	2160	5.528 €	B10R-159319AS	9	3190	2065	4.423 €
	B10R-159319BC	9,53	3190	2360	5.780 €	B10R-159319BS	9	3190	2265	4.672 €
	B10R-159319CC	10,4	3190	2560	6.036 €	B10R-159319CS	10	3190	2465	4.924 €
B11	B11R-159339AC	9,24	3390	2160	5.761 €	B11R-159339AS	9	3390	2065	4.583 €
	B11R-159339BC	10,16	3390	2360	6.026 €	B11R-159339BS	10	3390	2265	4.846 €
	B11R-159339CC	11,09	3390	2560	6.287 €	B11R-159339CS	11	3390	2465	5.112 €
B12	B12R-159359AC	9,81	3590	2160	5.992 €	B12R-159359AS	10	3590	2065	4.738 €
	B12R-159359BC	10,79	3590	2360	6.270 €	B12R-159359BS	11	3590	2265	5.013 €
	B12R-159359CC	11,77	3590	2560	6.546 €	B12R-159359CS	12	3590	2465	5.291 €
B13	B13R-159379AC	10,38	3790	2160	6.224 €	B13R-159379AS	10,3	3790	2065	4.890 €
	B13R-159379BC	11,42	3790	2360	6.513 €	B13R-159379BS	11,34	3790	2265	5.181 €
	B13R-159379CC	12,46	3790	2560	6.804 €	B13R-159379CS	12,38	3790	2465	5.471 €
B14	B14R-159399AC	10,95	3990	2160	6.456 €	B14R-159399AS	10,87	3990	2065	5.046 €
	B14R-159399BC	12,05	3990	2360	6.758 €	B14R-159399BS	11,97	3990	2265	5.348 €
	B14R-159399CC	13,14	3990	2560	7.061 €	B14R-159399CS	13,06	3990	2465	5.650 €
B15	B15R-159419AC	11,53	4190	2160	6.688 €	B15R-159419AS	11,44	4190	2065	5.201 €
	B15R-159419BC	12,68	4190	2360	7.004 €	B15R-159419BS	12,59	4190	2265	5.516 €
	B15R-159419CC	13,83	4190	2560	7.319 €	B15R-159419CS	13,74	4190	2465	5.830 €
B16	B16R-159439AC	12,1	4390	2160	6.920 €	B16R-159439AS	12,01	4390	2065	5.356 €
	B16R-159439BC	13,31	4390	2360	7.247 €	B16R-159439BS	13,22	4390	2265	5.683 €
	B16R-159439CC	14,52	4390	2560	7.575 €	B16R-159439CS	14,43	4390	2465	6.012 €
B17	B17R-159459AC	12,67	4590	2160	7.150 €	B17R-159459AS	12,57	4590	2065	5.510 €
	B17R-159459BC	13,94	4590	2360	7.492 €	B17R-159459BS	13,84	4590	2265	5.850 €
	B17R-159459CC	15,2	4590	2560	7.834 €	B17R-159459CS	15,11	4590	2465	6.192 €
B18	B18R-159479AC	13,24	4790	2160	7.382 €	B18R-159479AS	13,14	4790	2065	5.663 €
	B18R-159479BC	14,57	4790	2360	7.736 €	B18R-159479BS	14,47	4790	2265	6.018 €
	B18R-159479CC	15,89	4790	2560	8.090 €	B18R-159479CS	15,79	4790	2465	6.372 €
B19	B19R-159499AC	13,81	4990	2160	7.614 €	B19R-159499AS	13,71	4990	2065	5.819 €
	B19R-159499BC	15,2	4990	2360	7.981 €	B19R-159499BS	15,09	4990	2265	6.187 €
	B19R-159499CC	16,58	4990	2560	8.348 €	B19R-159499CS	16,47	4990	2465	6.551 €

100	Largo - Length (L)																			
	1430	1630	1830	2030	2230	2430	2630	2830	3030	3230	3430	3630	3830	4030	4230	4430	4630	4830	5030	
Fondo - Depth mm 1630	B1	B2	B3	B4	B5	B6	B7	B8	B9	B10	B11	B12	B13	B14	B15	B16	B17	B18	B19	

100	CON suelo - WITH floor panel					SIN suelo - WITHOUT floor panel				
	COD	m³	L	H	€	COD	m³	L	H	€
B1	B1C-163143AC	4,09	1630	2200	3.753 €	B1C-163143AS	4,06	1630	2085	3.288 €
	B1C-163143BC	4,5	1630	2400	3.919 €	B1C-163143BS	4,47	1630	2285	3.455 €
	B1C-163143CC	4,91	1630	2600	4.094 €	B1C-163143CS	4,88	1630	2485	3.630 €
B2	B2C-163163AC	4,09	1630	2200	3.989 €	B2C-163163AS	4	1630	2085	3.455 €
	B2C-163163BC	4,5	1630	2400	4.177 €	B2C-163163BS	4	1630	2285	3.642 €
	B2C-163163CC	4,91	1630	2600	4.357 €	B2C-163163CS	5	1630	2485	3.824 €
B3	B3C-163183AC	4,66	1830	2200	4.234 €	B3C-163183AS	5	1830	2085	3.630 €
	B3C-163183BC	5,13	1830	2400	4.428 €	B3C-163183BS	5	1830	2285	3.824 €
	B3C-163183CC	5,59	1830	2600	4.620 €	B3C-163183CS	6	1830	2485	4.010 €
B4	B4C-163203AC	5,23	2030	2200	4.473 €	B4C-163203AS	5	2030	2085	3.797 €
	B4C-163203BC	5,76	2030	2400	4.680 €	B4C-163203BS	6	2030	2285	4.003 €
	B4C-163203CC	6,28	2030	2600	4.885 €	B4C-163203CS	6	2030	2485	4.201 €
B5	B5C-163223AC	5,81	2230	2200	4.717 €	B5C-163223AS	6	2230	2085	3.965 €
	B5C-163223BC	6,39	2230	2400	4.938 €	B5C-163223BS	6	2230	2285	4.183 €
	B5C-163223CC	6,97	2230	2600	5.149 €	B5C-163223CS	7	2230	2485	4.396 €
B6	B6C-163243AC	6,38	2430	2200	4.962 €	B6C-163243AS	6	2430	2085	4.139 €
	B6C-163243BC	7,02	2430	2400	5.188 €	B6C-163243BS	7	2430	2285	4.363 €
	B6C-163243CC	7,65	2430	2600	5.413 €	B6C-163243CS	8	2430	2485	4.588 €
B7	B7C-163263AC	6,95	2630	2200	5.207 €	B7C-163263AS	7	2630	2085	4.305 €
	B7C-163263BC	7,64	2630	2400	5.439 €	B7C-163263BS	8	2630	2285	4.544 €
	B7C-163263CC	8,34	2630	2600	5.677 €	B7C-163263CS	8	2630	2485	4.776 €
B8	B8C-163283AC	7,52	2830	2200	5.445 €	B8C-163283AS	7	2830	2085	4.473 €
	B8C-163283BC	8,27	2830	2400	5.696 €	B8C-163283BS	8	2830	2285	4.717 €
	B8C-163283CC	9,03	2830	2600	5.942 €	B8C-163283CS	9	2830	2485	4.969 €
B9	B9C-163303AC	8,09	3030	2200	5.690 €	B9C-163303AS	8	3030	2085	4.648 €
	B9C-163303BC	8,9	3030	2400	5.947 €	B9C-163303BS	9	3030	2285	4.904 €
	B9C-163303CC	9,71	3030	2600	6.204 €	B9C-163303CS	10	3030	2485	5.162 €
B10	B10C-163323AC	8,67	3230	2200	5.928 €	B10C-163323AS	9	3230	2085	4.815 €
	B10C-163323BC	9,53	3230	2400	6.198 €	B10C-163323				

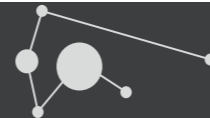

80	Largo - Length (L)																		
	1390	1590	1790	1990	2190	2390	2590	2790	2990	3190	3390	3590	3790	3990	4190	4390	4590	4790	4990
Fondo - Depth mm 1790	C1	C2	C3	C4	C5	C6	C7	C8	C9	C10	C11	C12	C13	C14	C15	C16	C17	C18	C19

80	CON suelo - WITH floor panel					SIN suelo - WITHOUT floor panel				
	COD	m³	L	H	€	COD	m³	L	H	€
C1	C1R-179139AC	4,01	1390	2160	3.650 €	C1R-179139AS	3,98	1390	2065	3.127 €
	C1R-179139BC	4,41	1390	2360	3.824 €	C1R-179139BS	4,38	1390	2265	3.301 €
	C1R-179139CC	4,81	1390	2560	3.989 €	C1R-179139CS	4,78	1390	2465	3.469 €
C2	C2R-179159AC	4,66	1590	2160	3.900 €	C2R-179159AS	4,63	1590	2065	3.295 €
	C2R-179159BC	5,13	1590	2360	4.080 €	C2R-179159BS	5,09	1590	2265	3.474 €
	C2R-179159CC	5,59	1590	2560	4.261 €	C2R-179159CS	5,56	1590	2465	3.662 €
C3	C3R-179179AC	5,31	1790	2160	4.145 €	C3R-179179AS	5	1790	2065	3.464 €
	C3R-179179BC	5,85	1790	2360	4.339 €	C3R-179179BS	6	1790	2265	3.656 €
	C3R-179179CC	6,38	1790	2560	4.531 €	C3R-179179CS	6	1790	2465	3.842 €
C4	C4R-179199AC	5,97	1990	2160	4.396 €	C4R-179199AS	6	1990	2065	3.630 €
	C4R-179199BC	6,56	1990	2360	4.596 €	C4R-179199BS	7	1990	2265	3.829 €
	C4R-179199CC	7,16	1990	2560	4.801 €	C4R-179199CS	7	1990	2465	4.028 €
C5	C5R-179219AC	6,62	2190	2160	4.641 €	C5R-179219AS	7	2190	2065	3.791 €
	C5R-179219BC	7,28	2190	2360	4.854 €	C5R-179219BS	7	2190	2265	4.003 €
	C5R-179219CC	7,94	2190	2560	5.066 €	C5R-179219CS	8	2190	2465	4.216 €
C6	C6R-179239AC	7,27	2390	2160	4.890 €	C6R-179239AS	7	2390	2065	3.959 €
	C6R-179239BC	8	2390	2360	5.112 €	C6R-179239BS	8	2390	2265	4.183 €
	C6R-179239CC	8,72	2390	2560	5.335 €	C6R-179239CS	9	2390	2465	4.403 €
C7	C7R-179259AC	7,92	2590	2160	5.135 €	C7R-179259AS	8	2590	2065	4.127 €
	C7R-179259BC	8,71	2590	2360	5.375 €	C7R-179259BS	9	2590	2265	4.357 €
	C7R-179259CC	9,51	2590	2560	5.606 €	C7R-179259CS	9	2590	2465	4.588 €
C8	C8R-179279AC	8,57	2790	2160	5.387 €	C8R-179279AS	9	2790	2065	4.286 €
	C8R-179279BC	9,43	2790	2360	5.632 €	C8R-179279BS	9	2790	2265	4.531 €
	C8R-179279CC	10,29	2790	2560	5.876 €	C8R-179279CS	10	2790	2465	4.776 €
C9	C9R-179299AC	9,23	2990	2160	5.639 €	C9R-179299AS	9	2990	2065	4.454 €
	C9R-179299BC	10,15	2990	2360	5.889 €	C9R-179299BS	10	2990	2265	4.711 €
	C9R-179299CC	11,07	2990	2560	6.141 €	C9R-179299CS	11	2990	2465	4.962 €
C10	C10R-179319AC	9,88	3190	2160	5.883 €	C10R-179319AS	10	3190	2065	4.620 €
	C10R-179319BC	10,87	3190	2360	6.147 €	C10R-179319BS	11	3190	2265	4.885 €
	C10R-179319CC	11,85	3190	2560	6.411 €	C10R-179319CS	12	3190	2465	5.149 €
C11	C11R-179339AC	10,53	3390	2160	6.134 €	C11R-179339AS	10	3390	2065	4.787 €
	C11R-179339BC	11,58	3390	2360	6.404 €	C11R-179339BS	12	3390	2265	5.058 €
	C11R-179339CC	12,64	3390	2560	6.680 €	C11R-179339CS	13	3390	2465	5.335 €
C12	C12R-179359AC	11,18	3590	2160	6.379 €	C12R-179359AS	11	3590	2065	4.949 €
	C12R-179359BC	12,3	3590	2360	6.669 €	C12R-179359BS	12	3590	2265	5.240 €
	C12R-179359CC	13,42	3590	2560	6.950 €	C12R-179359CS	13	3590	2465	5.522 €
C13	C13R-179379AC	11,83	3790	2160	6.630 €	C13R-179379AS	12	3790	2065	5.117 €
	C13R-179379BC	13,02	3790	2360	6.927 €	C13R-179379BS	13	3790	2265	5.413 €
	C13R-179379CC	14,2	3790	2560	7.221 €	C13R-179379CS	14	3790	2465	5.711 €
C14	C14R-179399AC	12,49	3990	2160	6.881 €	C14R-179399AS	12,39	3990	2065	5.285 €
	C14R-179399BC	13,73	3990	2360	7.182 €	C14R-179399BS	13,64	3990	2265	5.588 €
	C14R-179399CC	14,98	3990	2560	7.492 €	C14R-179399CS	14,89	3990	2465	5.897 €
C15	C15R-179419AC	13,14	4190	2160	7.132 €	C15R-179419AS	13,04	4190	2065	5.451 €
	C15R-179419BC	14,45	4190	2360	7.442 €	C15R-179419BS	14,35	4190	2265	5.761 €
	C15R-179419CC	15,77	4190	2560	7.762 €	C15R-179419CS	15,67	4190	2465	6.083 €
C14	C16R-179439AC	13,79	4390	2160	7.382 €	C16R-179439AS	13,69	4390	2065	5.617 €
	C16R-179439BC	15,17	4390	2360	7.697 €	C16R-179439BS	15,07	4390	2265	5.933 €
	C16R-179439CC	16,55	4390	2560	8.033 €	C16R-179439CS	16,44	4390	2465	6.270 €
C17	C17R-179459AC	14,44	4590	2160	7.634 €	C17R-179459AS	14,33	4590	2065	5.786 €
	C17R-179459BC	15,89	4590	2360	7.955 €	C17R-179459BS	15,78	4590	2265	6.108 €
	C17R-179459CC	17,33	4590	2560	8.303 €	C17R-179459CS	17,22	4590	2465	6.456 €
C18	C18R-179479AC	15,09	4790	2160	7.884 €	C18R-179479AS	14,98	4790	2065	5.953 €
	C18R-179479BC	16,6	4790	2360	8.212 €	C18R-179479BS	16,49	4790	2265	6.281 €
	C18R-179479CC	18,11	4790	2560	8.574 €	C18R-179479CS	18	4790	2465	6.641 €
C19	C19R-179499AC	15,75	4990	2160	8.136 €	C19R-179499AS	15,63	4990	2065	6.120 €
	C19R-179499BC	17,32	4990	2360	8.470 €	C19R-179499BS	17,2	4990	2265	6.456 €
	C19R-179499CC	18,89	4990	2560	8.845 €	C19R-179499CS	18,78	4990	2465	6.829 €

100	Largo - Length (L)																			
	1430	1630	1830	2030	2230	2430	2630	2830	3030	3230	3430	3630	3830	4030	4230	4430	4630	4830	5030	
Fondo - Depth mm 1830	C1	C2	C3	C4	C5	C6	C7	C8	C9	C10	C11	C12	C13	C14	C15	C16	C17	C18	C19	

100	CON suelo - WITH floor panel					SIN suelo - WITHOUT floor panel				
	COD	m³	L	H	€	COD	m³	L	H	€
C1	C1C-183143AC	4,01	1430	2200	3.977 €	C1C-183143AS	3,98	1430	2085	3.450 €
	C1C-183143BC	4,41	1430	2400	4.157 €	C1C-183143BS	4,38	1430	2285	3.636 €
	C1C-183143CC	4,81	1430	2600	4.339 €	C1C-183143CS	4,78	1430	2485	3.816 €
C2	C2C-183163AC	4,66	1630	2200	4.234 €	C2C-183163AS	4,63	1630	2085	3.630 €
	C2C-183163BC	5,13	1630	2400	4.428 €	C2C-183163BS	5,09	1630	2285	3.824 €
	C2C-183163CC	5,59	1630	2600	4.620 €	C2C-183163CS	5,56	1630	2485	4.010 €
C3	C3C-183183AC	5,31	1830	2200	4.492 €	C3C-183183AS	5	1830	2085	3.803 €
	C3C-183183BC	5,85	1830	2400	4.698 €	C3C-183183BS	6	1830	2285	4.003 €
	C3C-183183CC	6,38	1830	2600	4.899 €	C3C-183183CS	6	1830	2485	4.211 €
C4	C4C-183203AC	5,97	2030	2200	4.749 €	C4C-183203AS	6	2030	2085	3.977 €
	C4C-183203BC	6,56	2030	2400	4.962 €	C4C-183203BS	7	2030	2285	4.190 €
	C4C-183203CC	7,16	2030	2600	5.181 €	C4C-183203CS	7	2030	2485	4.409 €
C5	C5C-183223AC	6,62	2230	2200	5.007 €	C5C-183223AS	7	2230	2085	4.151 €
	C5C-183223BC	7,28	2230	2400	5.233 €	C5C-183223BS	7	2230	2285	4.376 €
	C5C-183223CC	7,94	2230	2600	5.458 €	C5C-183223CS	8	2230	2485	4.602 €
C6	C6C-183243AC	7,27	2430	2200	5.263 €	C6C-183243AS	7	2430	2085	4.325 €
	C6C-183243BC	8	2430	2400	5.504 €	C6C-183243BS	8	2430	2285	4.564 €
	C6C-183243CC	8,72	2430	2600	5.734 €	C6C-183243CS	9	2430	2485	4.801 €
C7	C7C-183263AC	7,92	2630	2200	5.522 €	C7C-183263AS	8	2630	2085	4.499 €
	C7C-183263BC	8,71	2630	2400	5.773 €	C7C-183263BS	9	2630	2285	4.749 €
	C7C-183263CC	9,51	2630	2600	6.018 €	C7C-183263CS	9	2630	2485	4.995 €
C8	C8C-183283AC	8,57	2830	2200	5.780 €	C8C-183283AS	9	2830	2085	4.680 €
	C8C-183283BC	9,43	2830	2400	6.036 €	C8C-183283BS	9	2830	2285	4.938 €
	C8C-183283CC	10,29	2830	2600	6.295 €	C8C-183283CS	10	2830	2485	5.196 €
C9	C9C-183303AC	9,23	3030	2200	6.036 €	C9C-183303AS	9	3030	2085	4.854 €
	C9C-183303BC	10,15	3030	2400	6.306 €	C9C-183303BS	10	3030	2285	5.117 €
	C9C-183303CC	11,07	3030	2600	6.578 €	C9C-183303CS	11	3030	2485	5.387 €
C10	C10C-183323AC	9,88	3230	2200	6.295 €	C10C-183323AS	10	3230	2085	5.027 €
	C10C-183323BC	10,87	3230	2400	6.578 €	C10C-183323BS	11	3230	2285	5.303 €
	C10C-183323CC	11,85	3230	2600	6.856 €	C10C-183323CS	12	3230	2485	5.588 €
C11	C11C-183343AC	10,53	3430	2200	6.551 €	C11C-183343AS	10	3430	2085	5.201 €
	C11C-183343BC	11,58	3430	2400	6.848 €	C11C-183343BS	12	3430	2285	5.489 €
	C11C-183343CC	12,64	3430	2600	7.254 €	C11C-183343CS	13	3430	2485	5.780 €
C12	C12C-183363AC	11,18	3630	2200	6.816 €	C12C-183363AS	11	3630	2085	5.375 €
	C12C-183363BC	12,3	3630	2400	7.235 €	C12C-183363BS	12	3630	2285	5.677 €
	C12C-183363CC	13,42	3630	2600	7.531 €					

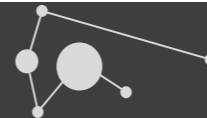

80	Largo - Length (L)																		
	1390	1590	1790	1990	2190	2390	2590	2790	2990	3190	3390	3590	3790	3990	4190	4390	4590	4790	4990
Fondo - Depth mm 1990	D1	D2	D3	D4	D5	D6	D7	D8	D9	D10	D11	D12	D13	D14	D15	D16	D17	D18	D19

80	CON suelo - WITH floor panel					SIN suelo - WITHOUT floor panel				
	COD	m³	L	H	€	COD	m³	L	H	€
D1	D1R-199139AC	4,5	1390	2160	3.868 €	D1R-199139AS	4,47	1390	2065	3.288 €
	D1R-199139BC	4,95	1390	2360	4.049 €	D1R-199139BS	4,92	1390	2265	3.469 €
	D1R-199139CC	5,4	1390	2560	4.229 €	D1R-199139CS	5,37	1390	2465	3.650 €
D2	D2R-199159AC	5,23	1590	2160	4.132 €	D2R-199159AS	5,19	1590	2065	3.455 €
	D2R-199159BC	5,76	1590	2360	4.325 €	D2R-199159BS	5,72	1590	2265	3.650 €
	D2R-199159CC	6,28	1590	2560	4.512 €	D2R-199159CS	6,24	1590	2465	3.842 €
D3	D3R-199179AC	5,97	1790	2160	4.396 €	D3R-199179AS	5,92	1790	2065	3.630 €
	D3R-199179BC	6,56	1790	2360	4.596 €	D3R-199179BS	6,52	1790	2265	3.829 €
	D3R-199179CC	7,16	1790	2560	4.801 €	D3R-199179CS	7,11	1790	2465	4.028 €
D4	D4R-199199AC	6,7	1990	2160	4.659 €	D4R-199199AS	6,65	1990	2065	3.797 €
	D4R-199199BC	7,37	1990	2360	4.871 €	D4R-199199BS	7,32	1990	2265	4.010 €
	D4R-199199CC	8,04	1990	2560	5.085 €	D4R-199199CS	7,99	1990	2465	4.222 €
D5	D5R-199219AC	7,43	2190	2160	4.924 €	D5R-199219AS	7,37	2190	2065	3.971 €
	D5R-199219BC	8,17	2190	2360	5.141 €	D5R-199219BS	8,12	2190	2265	4.190 €
	D5R-199219CC	8,92	2190	2560	5.368 €	D5R-199219CS	8,86	2190	2465	4.414 €
D6	D6R-199239AC	8,16	2390	2160	5.188 €	D6R-199239AS	8,1	2390	2065	4.139 €
	D6R-199239BC	8,98	2390	2360	5.419 €	D6R-199239BS	8,92	2390	2265	4.370 €
	D6R-199239CC	9,79	2390	2560	5.650 €	D6R-199239CS	9,73	2390	2465	4.609 €
D7	D7R-199259AC	8,89	2590	2160	5.451 €	D7R-199259AS	8,83	2590	2065	4.313 €
	D7R-199259BC	9,78	2590	2360	5.690 €	D7R-199259BS	9,72	2590	2265	4.556 €
	D7R-199259CC	10,67	2590	2560	5.933 €	D7R-199259CS	10,61	2590	2465	4.796 €
D8	D8R-199279AC	9,63	2790	2160	5.716 €	D8R-199279AS	9,55	2790	2065	4.481 €
	D8R-199279BC	10,59	2790	2360	5.966 €	D8R-199279BS	10,52	2790	2265	4.738 €
	D8R-199279CC	11,55	2790	2560	6.217 €	D8R-199279CS	11,48	2790	2465	4.988 €
D9	D9R-199299AC	10,36	2990	2160	5.973 €	D9R-199299AS	10,28	2990	2065	4.654 €
	D9R-199299BC	11,39	2990	2360	6.243 €	D9R-199299BS	11,32	2990	2265	4.918 €
	D9R-199299CC	12,43	2990	2560	6.501 €	D9R-199299CS	12,35	2990	2465	5.181 €
D10	D10R-199319AC	11,09	3190	2160	6.236 €	D10R-199319AS	11,01	3190	2065	4.820 €
	D10R-199319BC	12,2	3190	2360	6.513 €	D10R-199319BS	12,12	3190	2265	5.097 €
	D10R-199319CC	13,31	3190	2560	6.791 €	D10R-199319CS	13,22	3190	2465	5.375 €
D11	D11R-199339AC	11,82	3390	2160	6.501 €	D11R-199339AS	11,73	3390	2065	4.995 €
	D11R-199339BC	13	3390	2360	6.791 €	D11R-199339BS	12,92	3390	2265	5.277 €
	D11R-199339CC	14,19	3390	2560	7.073 €	D11R-199339CS	14,1	3390	2465	5.561 €
D12	D12R-199359AC	12,55	3590	2160	6.764 €	D12R-199359AS	12,46	3590	2065	5.162 €
	D12R-199359BC	13,81	3590	2360	7.061 €	D12R-199359BS	13,72	3590	2265	5.458 €
	D12R-199359CC	15,06	3590	2560	7.358 €	D12R-199359CS	14,97	3590	2465	5.755 €
D13	D13R-199379AC	13,29	3790	2160	7.028 €	D13R-199379AS	13,19	3790	2065	5.335 €
	D13R-199379BC	14,61	3790	2360	7.337 €	D13R-199379BS	14,51	3790	2265	5.639 €
	D13R-199379CC	15,94	3790	2560	7.614 €	D13R-199379CS	15,84	3790	2465	5.947 €
D14	D14R-199399AC	14,02	3990	2160	7.292 €	D14R-199399AS	13,91	3990	2065	5.504 €
	D14R-199399BC	15,42	3990	2360	7.608 €	D14R-199399BS	15,31	3990	2265	5.825 €
	D14R-199399CC	16,82	3990	2560	7.890 €	D14R-199399CS	16,72	3990	2465	6.141 €
D15	D15R-199419AC	14,75	4190	2160	7.557 €	D15R-199419AS	14,64	4190	2065	5.677 €
	D15R-199419BC	16,22	4190	2360	7.851 €	D15R-199419BS	16,11	4190	2265	6.004 €
	D15R-199419CC	17,7	4190	2560	8.168 €	D15R-199419CS	17,59	4190	2465	6.327 €
D16	D16R-199439AC	15,48	4390	2160	7.788 €	D16R-199439AS	15,37	4390	2065	5.844 €
	D16R-199439BC	17,03	4390	2360	8.123 €	D16R-199439BS	16,91	4390	2265	6.187 €
	D16R-199439CC	18,58	4390	2560	8.451 €	D16R-199439CS	18,46	4390	2465	6.519 €
D17	D17R-199459AC	16,21	4590	2160	8.051 €	D17R-199459AS	16,09	4590	2065	6.012 €
	D17R-199459BC	17,84	4590	2360	8.393 €	D17R-199459BS	17,71	4590	2265	6.359 €
	D17R-199459CC	19,46	4590	2560	8.730 €	D17R-199459CS	19,33	4590	2465	6.707 €
D18	D18R-199479AC	16,95	4790	2160	8.309 €	D18R-199479AS	16,82	4790	2065	6.178 €
	D18R-199479BC	18,64	4790	2360	8.663 €	D18R-199479BS	18,51	4790	2265	6.539 €
	D18R-199479CC	20,33	4790	2560	9.010 €	D18R-199479CS	20,21	4790	2465	6.893 €
D19	D19R-199499AC	17,68	4990	2160	8.574 €	D19R-199499AS	17,55	4990	2065	6.346 €
	D19R-199499BC	19,45	4990	2360	8.934 €	D19R-199499BS	19,31	4990	2265	6.713 €
	D19R-199499CC	21,21	4990	2560	9.295 €	D19R-199499CS	21,08	4990	2465	7.088 €

100	Largo - Length (L)																			
	1430	1630	1830	2030	2230	2430	2630	2830	3030	3230	3430	3630	3830	4030	4230	4430	4630	4830	5030	
Fondo - Depth mm 2030	D1	D2	D3	D4	D5	D6	D7	D8	D9	D10	D11	D12	D13	D14	D15	D16	D17	D18	D19	

100	CON suelo - WITH floor panel					SIN suelo - WITHOUT floor panel				
	COD	m³	L	H	€	COD	m³	L	H	€
D1	D1C-203143AC	4,5	1430	2200	4.201 €	D1C-203143AS	4,47	1430	2085	3.617 €
	D1C-203143BC	4,95	1430	2400	4.396 €	D1C-203143BS	4,92	1430	2285	3.809 €
	D1C-203143CC	5,4	1430	2600	4.588 €	D1C-203143CS	5,37	1430	2485	4.003 €
D2	D2C-203163AC	5,23	1630	2200	4.473 €	D2C-203163AS	5,19	1630	2085	3.797 €
	D2C-203163BC	5,76	1630	2400	4.680 €	D2C-203163BS	5,72	1630	2285	4.003 €
	D2C-203163CC	6,28	1630	2600	4.885 €	D2C-203163CS	6,24	1630	2485	4.201 €
D3	D3C-203183AC	5,97	1830	2200	4.749 €	D3C-203183AS	5,92	1830	2085	3.977 €
	D3C-203183BC	6,56	1830	2400	4.962 €	D3C-203183BS	6,52	1830	2285	4.190 €
	D3C-203183CC	7,16	1830	2600	5.181 €	D3C-203183CS	7,11	1830	2485	4.409 €
D4	D4C-203203AC	6,7	2030	2200	5.020 €	D4C-203203AS	6,65	2030	2085	4.157 €
	D4C-203203BC	7,37	2030	2400	5.245 €	D4C-203203BS	7,32	2030	2285	4.384 €
	D4C-203203CC	8,04	2030	2600	5.476 €	D4C-203203CS	7,99	2030	2485	4.609 €
D5	D5C-203223AC	7,43	2230	2200	5.297 €	D5C-203223AS	7,37	2230	2085	4.339 €
	D5C-203223BC	8,17	2230	2400	5.534 €	D5C-203223BS	8,12	2230	2285	4.575 €
	D5C-203223CC	8,92	2230	2600	5.766 €	D5C-203223CS	8,86	2230	2485	4.809 €
D6	D6C-203243AC	8,16	2430	2200	5.573 €	D6C-203243AS	8,1	2430	2085	4.517 €
	D6C-203243BC	8,98	2430	2400	5.819 €	D6C-203243BS	8,92	2430	2285	4.762 €
	D6C-203243CC	9,79	2430	2600	6.064 €	D6C-203243CS	9,73	2430	2485	5.013 €
D7	D7C-203263AC	8,89	2630	2200	5.844 €	D7C-203263AS	8,83	2630	2085	4.698 €
	D7C-203263BC	9,78	2630	2400	6.102 €	D7C-203263BS	9,72	2630	2285	4.956 €
	D7C-203263CC	10,67	2630	2600	6.359 €	D7C-203263CS	10,61	2630	2485	5.214 €
D8	D8C-203283AC	9,63	2830	2200	6.120 €	D8C-203283AS	9,55	2830	2085	4.879 €
	D8C-203283BC	10,59	2830	2400	6.385 €	D8C-203283BS	10,52	2830	2285	5.149 €
	D8C-203283CC	11,55	2830	2600	6.656 €	D8C-203283CS	11,48	2830	2485	5.419 €
D9	D9C-203303AC	10,36	3030	2200	6.390 €	D9C-203303AS	10,28	3030	2085	5.058 €
	D9C-203303BC	11,39	3030	2400	6.669 €	D9C-203303BS	11,32	3030	2285	5.342 €
	D9C-203303CC	12,43	3030	2600	6.950 €	D9C-203303CS	12,35	3030	2485	5.617 €
D10	D10C-203323AC	11,09	3230	2200</						



80	Largo - Length (L)																		
	1390	1590	1790	1990	2190	2390	2590	2790	2990	3190	3390	3590	3790	3990	4190	4390	4590	4790	4990
Fondo - Depth mm 2190	E1	E2	E3	E4	E5	E6	E7	E8	E9	E10	E11	E12	E13	E14	E15	E16	E17	E18	E19

80	CON suelo - WITH floor panel					SIN suelo - WITHOUT floor panel				
	COD	m³	L	H	€	COD	m³	L	H	€
E1	E1R-219139AC	4,99	1390	2160	4.088 €	E1R-219139AS	4,96	1390	2065	3.443 €
	E1R-219139BC	5,49	1390	2360	4.280 €	E1R-219139BS	5,46	1390	2265	3.630 €
	E1R-219139CC	5,99	1390	2560	4.467 €	E1R-219139CS	5,96	1390	2465	3.824 €
E2	E2R-219159AC	5,81	1590	2160	4.363 €	E2R-219159AS	5,76	1590	2065	3.617 €
	E2R-219159BC	6,39	1590	2360	4.564 €	E2R-219159BS	6,34	1590	2265	3.816 €
	E2R-219159CC	6,97	1590	2560	4.770 €	E2R-219159CS	6,92	1590	2465	4.023 €
E3	E3R-219179AC	6,62	1790	2160	4.641 €	E3R-219179AS	6,57	1790	2065	3.791 €
	E3R-219179BC	7,28	1790	2360	4.854 €	E3R-219179BS	7,23	1790	2265	4.003 €
	E3R-219179CC	7,94	1790	2560	5.066 €	E3R-219179CS	7,89	1790	2465	4.216 €
E4	E4R-219199AC	7,43	1990	2160	4.924 €	E4R-219199AS	7,37	1990	2065	3.971 €
	E4R-219199BC	8,17	1990	2360	5.141 €	E4R-219199BS	8,12	1990	2265	4.151 €
	E4R-219199CC	8,92	1990	2560	5.368 €	E4R-219199CS	8,86	1990	2465	4.414 €
E5	E5R-219219AC	8,24	2190	2160	5.201 €	E5R-219219AS	8	2190	2065	4.145 €
	E5R-219219BC	9,07	2190	2360	5.432 €	E5R-219219BS	9	2190	2265	4.376 €
	E5R-219219CC	9,89	2190	2560	5.663 €	E5R-219219CS	10	2190	2465	4.609 €
E6	E6R-219239AC	9,05	2390	2160	5.476 €	E6R-219239AS	9	2390	2065	4.318 €
	E6R-219239BC	9,96	2390	2360	5.721 €	E6R-219239BS	10	2390	2265	4.564 €
	E6R-219239CC	10,86	2390	2560	5.966 €	E6R-219239CS	11	2390	2465	4.809 €
E7	E7R-219259AC	9,87	2590	2160	5.761 €	E7R-219259AS	10	2590	2065	4.499 €
	E7R-219259BC	10,85	2590	2360	6.012 €	E7R-219259BS	11	2590	2265	4.749 €
	E7R-219259CC	11,84	2590	2560	6.262 €	E7R-219259CS	12	2590	2465	5.007 €
E8	E8R-219279AC	10,68	2790	2160	6.036 €	E8R-219279AS	11	2790	2065	4.672 €
	E8R-219279BC	11,75	2790	2360	6.301 €	E8R-219279BS	12	2790	2265	4.938 €
	E8R-219279CC	12,81	2790	2560	6.565 €	E8R-219279CS	13	2790	2465	5.201 €
E9	E9R-219299AC	11,49	2990	2160	6.315 €	E9R-219299AS	11	2990	2065	4.846 €
	E9R-219299BC	12,64	2990	2360	6.591 €	E9R-219299BS	13	2990	2265	5.125 €
	E9R-219299CC	13,79	2990	2560	6.867 €	E9R-219299CS	14	2990	2465	5.400 €
E10	E10R-219319AC	12,3	3190	2160	6.596 €	E10R-219319AS	12	3190	2065	5.027 €
	E10R-219319BC	13,53	3190	2360	6.881 €	E10R-219319BS	13	3190	2265	5.310 €
	E10R-219319CC	14,76	3190	2560	7.163 €	E10R-219319CS	15	3190	2465	5.593 €
E11	E11R-219339AC	13,11	3390	2160	6.875 €	E11R-219339AS	13	3390	2065	5.201 €
	E11R-219339BC	14,43	3390	2360	7.171 €	E11R-219339BS	14	3390	2265	5.497 €
	E11R-219339CC	15,74	3390	2560	7.465 €	E11R-219339CS	16	3390	2465	5.792 €
E12	E12R-219359AC	13,93	3590	2160	7.150 €	E12R-219359AS	14	3590	2065	5.375 €
	E12R-219359BC	15,32	3590	2360	7.460 €	E12R-219359BS	15	3590	2265	5.683 €
	E12R-219359CC	16,71	3590	2560	7.736 €	E12R-219359CS	17	3590	2465	5.986 €
E13	E13R-219379AC	14,74	3790	2160	7.429 €	E13R-219379AS	15	3790	2065	5.555 €
	E13R-219379BC	16,21	3790	2360	7.717 €	E13R-219379BS	16	3790	2265	5.870 €
	E13R-219379CC	17,69	3790	2560	8.027 €	E13R-219379CS	18	3790	2465	6.187 €
E14	E14R-219399AC	15,55	3990	2160	7.711 €	E14R-219399AS	15	3990	2065	5.729 €
	E14R-219399BC	17,1	3990	2360	8.001 €	E14R-219399BS	17	3990	2265	6.057 €
	E14R-219399CC	18,66	3990	2560	8.321 €	E14R-219399CS	19	3990	2465	6.379 €
E15	E15R-219419AC	16,36	4190	2160	7.955 €	E15R-219419AS	16	4190	2065	5.903 €
	E15R-219419BC	18	4190	2360	8.283 €	E15R-219419BS	18	4190	2265	6.243 €
	E15R-219419CC	19,63	4190	2560	8.612 €	E15R-219419CS	20	4190	2465	6.578 €
E16	E16R-219439AC	17,17	4390	2160	8.225 €	E16R-219439AS	17	4390	2065	6.083 €
	E16R-219439BC	18,89	4390	2360	8.566 €	E16R-219439BS	19	4390	2265	6.429 €
	E16R-219439CC	20,61	4390	2560	8.908 €	E16R-219439CS	20	4390	2465	6.777 €
E17	E17R-219459AC	17,99	4590	2160	8.495 €	E17R-219459AS	18	4590	2065	6.257 €
	E17R-219459BC	19,78	4590	2360	8.850 €	E17R-219459BS	20	4590	2265	6.617 €
	E17R-219459CC	21,58	4590	2560	9.198 €	E17R-219459CS	21	4590	2465	6.971 €
E18	E18R-219479AC	18,8	4790	2160	8.774 €	E18R-219479AS	19	4790	2065	6.429 €
	E18R-219479BC	20,68	4790	2360	9.133 €	E18R-219479BS	21	4790	2265	6.796 €
	E18R-219479CC	22,56	4790	2560	9.494 €	E18R-219479CS	22	4790	2465	7.163 €
E19	E19R-219499AC	19,61	4990	2160	9.050 €	E19R-219499AS	19	4990	2065	6.596 €
	E19R-219499BC	21,57	4990	2360	9.423 €	E19R-219499BS	21	4990	2265	6.976 €
	E19R-219499CC	23,53	4990	2560	9.792 €	E19R-219499CS	23	4990	2465	7.358 €

100	Largo - Length (L)																			
	1430	1630	1830	2030	2230	2430	2630	2830	3030	3230	3430	3630	3830	4030	4230	4430	4630	4830	5030	
Fondo - Depth mm 2230	E1	E2	E3	E4	E5	E6	E7	E8	E9	E10	E11	E12	E13	E14	E15	E16	E17	E18	E19	

100	CON suelo - WITH floor panel					SIN suelo - WITHOUT floor panel				
	COD	m³	L	H	€	COD	m³	L	H	€
E1	E1C-223143AC	4,99	1430	2200	4.428 €	E1C-223143AS	4,96	1430	2085	3.779 €
	E1C-223143BC	5,49	1430	2400	4.633 €	E1C-223143BS	5,46	1430	2285	3.984 €
	E1C-223143CC	5,99	1430	2600	4.840 €	E1C-223143CS	5,96	1430	2485	4.190 €
E2	E2C-223163AC	5,81	1630	2200	4.717 €	E2C-223163AS	5,76	1630	2085	3.965 €
	E2C-223163BC	6,39	1630	2400	4.938 €	E2C-223163BS	6,34	1630	2285	4.183 €
	E2C-223163CC	6,97	1630	2600	5.149 €	E2C-223163CS	6,92	1630	2485	4.396 €
E3	E3C-223183AC	6,62	1830	2200	5.007 €	E3C-223183AS	6,57	1830	2085	4.151 €
	E3C-223183BC	7,28	1830	2400	5.233 €	E3C-223183BS	7,23	1830	2285	4.376 €
	E3C-223183CC	7,94	1830	2600	5.458 €	E3C-223183CS	7,89	1830	2485	4.602 €
E4	E4C-223203AC	7,43	2030	2200	5.297 €	E4C-223203AS	7,37	2030	2085	4.339 €
	E4C-223203BC	8,17	2030	2400	5.534 €	E4C-223203BS	8,12	2030	2285	4.575 €
	E4C-223203CC	8,92	2030	2600	5.766 €	E4C-223203CS	8,86	2030	2485	4.809 €
E5	E5C-223223AC	8,24	2230	2200	5.588 €	E5C-223223AS	8	2230	2085	4.526 €
	E5C-223223BC	9,07	2230	2400	5.830 €	E5C-223223BS	9	2230	2285	4.770 €
	E5C-223223CC	9,89	2230	2600	6.083 €	E5C-223223CS	10	2230	2485	5.020 €
E6	E6C-223243AC	9,05	2430	2200	5.876 €	E6C-223243AS	9	2430	2085	4.711 €
	E6C-223243BC	9,96	2430	2400	6.134 €	E6C-223243BS	10	2430	2285	4.969 €
	E6C-223243CC	10,86	2430	2600	6.390 €	E6C-223243CS	11	2430	2485	5.225 €
E7	E7C-223263AC	9,87	2630	2200	6.165 €	E7C-223263AS	10	2630	2085	4.899 €
	E7C-223263BC	10,85	2630	2400	6.429 €	E7C-223263BS	11	2630	2285	5.162 €
	E7C-223263CC	11,84	2630	2600	6.701 €	E7C-223263CS	12	2630	2485	5.432 €
E8	E8C-223283AC	10,68	2830	2200	6.456 €	E8C-223283AS	11	2830	2085	5.078 €
	E8C-223283BC	11,75	2830	2400	6.733 €	E8C-223283BS	12	2830	2285	5.361 €
	E8C-223283CC	12,81	2830	2600	7.009 €	E8C-223283CS	13	2830	2485	5.639 €
E9	E9C-223303AC	11,49	3030	2200	6.745 €	E9C-223303AS	11	3030	2085	5.263 €
	E9C-223303BC	12,64	3030	2400	7.034 €	E9C-223303BS	13	3030	2285	5.555 €
	E9C-223303CC	13,79	3030	2600	7.442 €	E9C-223303CS	14	3030	2485	5.850 €
E10	E10C-223323AC	12,3	3230	2200	7.028 €	E10C-223323AS	12	3230	2085	5.451 €
	E10C-223323BC	13,53	3230	2400	7.447 €	E10C-223323BS	13	3230	2285	5.755 €
	E10C-223323CC	14,76	3230	2600	7.750 €	E10C-223323CS	15	3230	2485	6.057 €
E11	E11C-223343AC	13,11	3430	2200	7.434 €	E11C-223343AS	13	3430	2085	5.639 €
	E11C-223343BC	14,43	3430	2400	7.750 €	E11C-223343BS	14	3430	2285	5.953 €
	E11C-223343CC	15,74	3430	2600	8.059 €	E11C-223343CS	16	3430	2485	6.262 €
E12	E12C-223363AC	13,93	3630	2200	7.723 €	E12C-223363AS	14	3630	2085	5.825 €
	E12C-223363BC	15,32	3630	2400	8.046 €	E12C-223363BS	15	3630	2285	6.147 €
	E12C-223363CC	16,71	36							

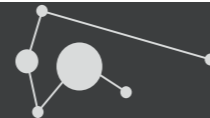

80	Largo - Length (L)																		
	1390	1590	1790	1990	2190	2390	2590	2790	2990	3190	3390	3590	3790	3990	4190	4390	4590	4790	4990
Fondo - Depth mm 2390	F1	F2	F3	F4	F5	F6	F7	F8	F9	F10	F11	F12	F13	F14	F15	F16	F17	F18	F19

80	CON suelo - WITH floor panel					SIN suelo - WITHOUT floor panel				
	COD	m³	L	H	€	COD	m³	L	H	€
F1	F1R-239139AC	5,49	1390	2160	4.305 €	F1R-239139AS	5,44	1390	2065	3.597 €
	F1R-239139BC	6,03	1390	2360	4.504 €	F1R-239139BS	5,99	1390	2265	3.797 €
	F1R-239139CC	6,58	1390	2560	4.704 €	F1R-239139CS	6,54	1390	2465	3.997 €
F2	F2R-239159AC	6,38	1590	2160	4.596 €	F2R-239159AS	6,33	1590	2065	3.779 €
	F2R-239159BC	7,02	1590	2360	4.809 €	F2R-239159BS	6,97	1590	2265	3.989 €
	F2R-239159CC	7,65	1590	2560	5.020 €	F2R-239159CS	7,61	1590	2465	4.201 €
F3	F3R-239179AC	7,27	1790	2160	4.890 €	F3R-239179AS	7,22	1790	2065	3.959 €
	F3R-239179BC	8	1790	2360	5.112 €	F3R-239179BS	7,94	1790	2265	4.183 €
	F3R-239179CC	8,72	1790	2560	5.335 €	F3R-239179CS	8,67	1790	2465	4.403 €
F4	F4R-239199AC	8,16	1990	2160	5.188 €	F4R-239199AS	8,1	1990	2065	4.139 €
	F4R-239199BC	8,98	1990	2360	5.419 €	F4R-239199BS	8,92	1990	2265	4.370 €
	F4R-239199CC	9,79	1990	2560	5.650 €	F4R-239199CS	9,73	1990	2465	4.609 €
F5	F5R-239219AC	9,05	2190	2160	5.439 €	F5R-239219AS	8,99	2190	2065	4.318 €
	F5R-239219BC	9,96	2190	2360	5.721 €	F5R-239219BS	9,89	2190	2265	4.564 €
	F5R-239219CC	10,86	2190	2560	5.966 €	F5R-239219CS	10,8	2190	2465	4.809 €
F6	F6R-239239AC	9,95	2390	2160	5.773 €	F6R-239239AS	10	2390	2065	4.499 €
	F6R-239239BC	10,94	2390	2360	6.026 €	F6R-239239BS	11	2390	2265	4.757 €
	F6R-239239CC	11,93	2390	2560	6.281 €	F6R-239239CS	12	2390	2465	5.007 €
F7	F7R-239259AC	10,84	2590	2160	6.070 €	F7R-239259AS	11	2590	2065	4.687 €
	F7R-239259BC	11,92	2590	2360	6.334 €	F7R-239259BS	12	2590	2265	4.949 €
	F7R-239259CC	13,01	2590	2560	6.596 €	F7R-239259CS	13	2590	2465	5.214 €
F8	F8R-239279AC	11,73	2790	2160	6.359 €	F8R-239279AS	12	2790	2065	4.866 €
	F8R-239279BC	12,9	2790	2360	6.635 €	F8R-239279BS	13	2790	2265	5.135 €
	F8R-239279CC	14,08	2790	2560	6.913 €	F8R-239279CS	14	2790	2465	5.413 €
F9	F9R-239299AC	12,62	2990	2160	6.656 €	F9R-239299AS	13	2990	2065	5.046 €
	F9R-239299BC	13,88	2990	2360	6.938 €	F9R-239299BS	14	2990	2265	5.329 €
	F9R-239299CC	15,15	2990	2560	7.229 €	F9R-239299CS	15	2990	2465	5.612 €
F10	F10R-239319AC	13,51	3190	2160	6.950 €	F10R-239319AS	13	3190	2065	5.225 €
	F10R-239319BC	14,87	3190	2360	7.247 €	F10R-239319BS	15	3190	2265	5.522 €
	F10R-239319CC	16,22	3190	2560	7.543 €	F10R-239319CS	16	3190	2465	5.819 €
F11	F11R-239339AC	14,41	3390	2160	7.241 €	F11R-239339AS	14	3390	2065	5.405 €
	F11R-239339BC	15,85	3390	2360	7.550 €	F11R-239339BS	16	3390	2265	5.716 €
	F11R-239339CC	17,29	3390	2560	7.826 €	F11R-239339CS	17	3390	2465	6.018 €
F12	F12R-239359AC	15,3	3590	2160	7.536 €	F12R-239359AS	15	3590	2065	5.588 €
	F12R-239359BC	16,83	3590	2360	7.820 €	F12R-239359BS	17	3590	2265	5.903 €
	F12R-239359CC	18,36	3590	2560	8.130 €	F12R-239359CS	18	3590	2465	6.224 €
F13	F13R-239379AC	16,19	3790	2160	7.801 €	F13R-239379AS	16	3790	2065	5.766 €
	F13R-239379BC	17,81	3790	2360	8.123 €	F13R-239379BS	18	3790	2265	6.097 €
	F13R-239379CC	19,43	3790	2560	8.438 €	F13R-239379CS	19	3790	2465	6.423 €
F14	F14R-239399AC	17,08	3990	2160	8.090 €	F14R-239399AS	17	3990	2065	5.953 €
	F14R-239399BC	18,79	3990	2360	8.420 €	F14R-239399BS	19	3990	2265	6.287 €
	F14R-239399CC	20,5	3990	2560	8.747 €	F14R-239399CS	20	3990	2465	6.623 €
F15	F15R-239419AC	17,97	4190	2160	8.376 €	F15R-239419AS	18	4190	2065	6.134 €
	F15R-239419BC	19,77	4190	2360	8.716 €	F15R-239419BS	20	4190	2265	6.481 €
	F15R-239419CC	21,57	4190	2560	9.056 €	F15R-239419CS	21	4190	2465	6.829 €
F16	F16R-239439AC	18,87	4390	2160	8.663 €	F16R-239439AS	19	4390	2065	6.315 €
	F16R-239439BC	20,75	4390	2360	9.010 €	F16R-239439BS	21	4390	2265	6.669 €
	F16R-239439CC	22,64	4390	2560	9.366 €	F16R-239439CS	23	4390	2465	7.028 €
F17	F17R-239459AC	19,76	4590	2160	8.947 €	F17R-239459AS	20	4590	2065	6.494 €
	F17R-239459BC	21,73	4590	2360	9.306 €	F17R-239459BS	22	4590	2265	6.861 €
	F17R-239459CC	23,71	4590	2560	9.669 €	F17R-239459CS	24	4590	2465	7.221 €
F18	F18R-239479AC	20,65	4790	2160	9.237 €	F18R-239479AS	20	4790	2065	6.674 €
	F18R-239479BC	22,71	4790	2360	9.609 €	F18R-239479BS	23	4790	2265	7.054 €
	F18R-239479CC	24,78	4790	2560	9.976 €	F18R-239479CS	25	4790	2465	7.420 €
F19	F19R-239499AC	21,54	4990	2160	9.533 €	F19R-239499AS	21	4990	2065	6.856 €
	F19R-239499BC	23,7	4990	2360	9.911 €	F19R-239499BS	24	4990	2265	7.247 €
	F19R-239499CC	25,85	4990	2560	10.292 €	F19R-239499CS	26	4990	2465	7.620 €

100	Largo - Length (L)																		
	1430	1630	1830	2030	2230	2430	2630	2830	3030	3230	3430	3630	3830	4030	4230	4430	4630	4830	5030
Fondo - Depth mm 2430	F1	F2	F3	F4	F5	F6	F7	F8	F9	F10	F11	F12	F13	F14	F15	F16	F17	F18	F19

100	CON suelo - WITH floor panel					SIN suelo - WITHOUT floor panel				
	COD	m³	L	H	€	COD	m³	L	H	€
F1	F1C-243143AC	5,49	1430	2200	4.659 €	F1C-243143AS	5,44	1430	2085	3.945 €
	F1C-243143BC	6,03	1430	2400	4.871 €	F1C-243143BS	5,99	1430	2285	4.157 €
	F1C-243143CC	6,58	1430	2600	5.085 €	F1C-243143CS	6,54	1430	2485	4.370 €
F2	F2C-243163AC	6,38	1630	2200	4.962 €	F2C-243163AS	6,33	1630	2085	4.139 €
	F2C-243163BC	7,02	1630	2400	5.188 €	F2C-243163BS	6,97	1630	2285	4.363 €
	F2C-243163CC	7,65	1630	2600	5.413 €	F2C-243163CS	7,61	1630	2485	4.588 €
F3	F3C-243183AC	7,27	1830	2200	5.263 €	F3C-243183AS	7,22	1830	2085	4.325 €
	F3C-243183BC	8	1830	2400	5.504 €	F3C-243183BS	7,94	1830	2285	4.564 €
	F3C-243183CC	8,72	1830	2600	5.734 €	F3C-243183CS	8,67	1830	2485	4.801 €
F4	F4C-243203AC	8,16	2030	2200	5.573 €	F4C-243203AS	8,1	2030	2085	4.517 €
	F4C-243203BC	8,98	2030	2400	5.819 €	F4C-243203BS	8,92	2030	2285	4.762 €
	F4C-243203CC	9,79	2030	2600	6.064 €	F4C-243203CS	9,73	2030	2485	5.013 €
F5	F5C-243223AC	9,05	2230	2200	5.876 €	F5C-243223AS	8,99	2230	2085	4.711 €
	F5C-243223BC	9,96	2230	2400	6.134 €	F5C-243223BS	9,89	2230	2285	4.969 €
	F5C-243223CC	10,86	2230	2600	6.390 €	F5C-243223CS	10,8	2230	2485	5.225 €
F6	F6C-243243AC	9,95	2430	2200	6.178 €	F6C-243243AS	10	2430	2085	4.899 €
	F6C-243243BC	10,94	2430	2400	6.450 €	F6C-243243BS	11	2430	2285	5.169 €
	F6C-243243CC	11,93	2430	2600	6.719 €	F6C-243243CS	12	2430	2485	5.439 €
F7	F7C-243263AC	10,84	2630	2200	6.481 €	F7C-243263AS	11	2630	2085	5.091 €
	F7C-243263BC	11,92	2630	2400	6.764 €	F7C-243263BS	12	2630	2285	5.375 €
	F7C-243263CC	13,01	2630	2600	7.043 €	F7C-243263CS	13	2630	2485	5.650 €
F8	F8C-243283AC	11,73	2830	2200	6.791 €	F8C-243283AS	12	2830	2085	5.285 €
	F8C-243283BC	12,9	2830	2400	7.079 €	F8C-243283BS	13	2830	2285	5.573 €
	F8C-243283CC	14,08	2830	2600	7.486 €	F8C-243283CS	14	2830	2485	5.863 €
F9	F9C-243303AC	12,62	3030	2200	7.093 €	F9C-243303AS	13	3030	2085	5.476 €
	F9C-243303BC	13,88	3030	2400	7.512 €	F9C-243303BS	14	3030	2285	5.773 €
	F9C-243303CC	15,15	3030	2600	7.815 €	F9C-243303CS	15	3030	2485	6.075 €
F10	F10C-243323AC	13,51	3230	2200	7.518 €	F10C-243323AS	13	3230	2085	5.663 €
	F10C-243323BC	14,87	3230	2400	7.826 €	F10C-243323BS	15	3230	2285	5.980 €
	F10C-243323CC	16,22	3230	2600	8.141 €	F10C-243323CS	16	3230	2485	6.287 €
F11	F11C-243343AC	14,41	3430	2200	7.820 €	F11C-243343AS	14	3430	2085	5.858 €
	F11C-243343BC	15,85	3430	2400	8.141 €	F11C-243343BS	16	3430	2285	6.178 €
	F11C-243343CC	17,29	3430	2600	8.309 €	F11C-243343CS	17	3430	2485	6.501 €
F12	F12C-243363AC	15,3	3630	2200	8.123 €	F12C-243363AS	15	3630	2085	6.049 €
	F12C-243363BC	16,83	3630	2400	8.303 €	F12C-243363BS	17	3630	2285	6.385 €
	F12C-243363CC									



80	Largo - Length (L)																		
	1390	1590	1790	1990	2190	2390	2590	2790	2990	3190	3390	3590	3790	3990	4190	4390	4590	4790	4990
Fondo - Depth mm 2590	G1	G2	G3	G4	G5	G6	G7	G8	G9	G10	G11	G12	G13	G14	G15	G16	G17	G18	G19

80	CON suelo - WITH floor panel					SIN suelo - WITHOUT floor panel				
	COD	m²	L	H	€	COD	m²	L	H	€
G1	G1R-259139AC	5,98	1390	2160	4.517 €	G1R-259139AS	5,93	1390	2065	3.753 €
	G1R-259139BC	6,58	1390	2360	4.731 €	G1R-259139BS	6,53	1390	2265	3.965 €
	G1R-259139CC	7,17	1390	2560	4.943 €	G1R-259139CS	7,13	1390	2465	4.177 €
G2	G2R-259159AC	6,95	1590	2160	4.827 €	G2R-259159AS	6,9	1590	2065	3.939 €
	G2R-259159BC	7,64	1590	2360	5.052 €	G2R-259159BS	7,59	1590	2265	4.157 €
	G2R-259159CC	8,34	1590	2560	5.277 €	G2R-259159CS	8,29	1590	2465	4.384 €
G3	G3R-259179AC	7,92	1790	2160	5.135 €	G3R-259179AS	7,86	1790	2065	4.127 €
	G3R-259179BC	8,71	1790	2360	5.375 €	G3R-259179BS	8,65	1790	2265	4.357 €
	G3R-259179CC	9,51	1790	2560	5.606 €	G3R-259179CS	9,45	1790	2465	4.588 €
G4	G4R-259199AC	8,89	1990	2160	5.451 €	G4R-259199AS	8,83	1990	2065	4.313 €
	G4R-259199BC	9,78	1990	2360	5.690 €	G4R-259199BS	9,72	1990	2265	4.556 €
	G4R-259199CC	10,67	1990	2560	5.933 €	G4R-259199CS	10,61	1990	2465	4.796 €
G5	G5R-259219AC	9,87	2190	2160	5.761 €	G5R-259219AS	9,79	2190	2065	4.499 €
	G5R-259219BC	10,85	2190	2360	6.012 €	G5R-259219BS	10,78	2190	2265	4.749 €
	G5R-259219CC	11,84	2190	2560	6.262 €	G5R-259219CS	11,76	2190	2465	5.007 €
G6	G6R-259239AC	10,84	2390	2160	6.070 €	G6R-259239AS	10,76	2390	2065	4.687 €
	G6R-259239BC	11,92	2390	2360	6.334 €	G6R-259239BS	11,84	2390	2265	4.949 €
	G6R-259239CC	13,01	2390	2560	6.596 €	G6R-259239CS	12,92	2390	2465	5.214 €
G7	G7R-259259AC	11,81	2590	2160	6.379 €	G7R-259259AS	12	2590	2065	4.866 €
	G7R-259259BC	12,99	2590	2360	6.649 €	G7R-259259BS	13	2590	2265	5.141 €
	G7R-259259CC	14,17	2590	2560	6.927 €	G7R-259259CS	14	2590	2465	5.419 €
G8	G8R-259279AC	12,78	2790	2160	6.688 €	G8R-259279AS	13	2790	2065	5.058 €
	G8R-259279BC	14,06	2790	2360	6.971 €	G8R-259279BS	14	2790	2265	5.342 €
	G8R-259279CC	15,34	2790	2560	7.260 €	G8R-259279CS	15	2790	2465	5.627 €
G9	G9R-259299AC	13,75	2990	2160	6.996 €	G9R-259299AS	14	2990	2065	5.240 €
	G9R-259299BC	15,13	2990	2360	7.292 €	G9R-259299BS	15	2990	2265	5.534 €
	G9R-259299CC	16,5	2990	2560	7.589 €	G9R-259299CS	16	2990	2465	5.830 €
G10	G10R-259319AC	14,73	3190	2160	7.305 €	G10R-259319AS	15	3190	2065	5.427 €
	G10R-259319BC	16,2	3190	2360	7.608 €	G10R-259319BS	16	3190	2265	5.734 €
	G10R-259319CC	17,67	3190	2560	7.884 €	G10R-259319CS	18	3190	2465	6.036 €
G11	G11R-259339AC	15,7	3390	2160	7.614 €	G11R-259339AS	16	3390	2065	5.612 €
	G11R-259339BC	17,27	3390	2360	7.897 €	G11R-259339BS	17	3390	2265	5.928 €
	G11R-259339CC	18,84	3390	2560	8.207 €	G11R-259339CS	19	3390	2465	6.250 €
G12	G12R-259359AC	16,67	3590	2160	7.890 €	G12R-259359AS	17	3590	2065	5.800 €
	G12R-259359BC	18,34	3590	2360	8.207 €	G12R-259359BS	18	3590	2265	6.127 €
	G12R-259359CC	20	3590	2560	8.527 €	G12R-259359CS	20	3590	2465	6.456 €
G13	G13R-259379AC	17,64	3790	2160	8.193 €	G13R-259379AS	18	3790	2065	5.986 €
	G13R-259379BC	19,41	3790	2360	8.522 €	G13R-259379BS	19	3790	2265	6.327 €
	G13R-259379CC	21,17	3790	2560	8.850 €	G13R-259379CS	21	3790	2465	6.662 €
G14	G14R-259399AC	18,61	3990	2160	8.495 €	G14R-259399AS	18	3990	2065	6.173 €
	G14R-259399BC	20,48	3990	2360	8.830 €	G14R-259399BS	20	3990	2265	6.519 €
	G14R-259399CC	22,34	3990	2560	9.172 €	G14R-259399CS	22	3990	2465	6.867 €
G15	G15R-259419AC	19,59	4190	2160	8.798 €	G15R-259419AS	19	4190	2065	6.359 €
	G15R-259419BC	21,54	4190	2360	9.147 €	G15R-259419BS	21	4190	2265	6.719 €
	G15R-259419CC	23,5	4190	2560	9.494 €	G15R-259419CS	23	4190	2465	7.073 €
G16	G16R-259439AC	20,56	4390	2160	9.102 €	G16R-259439AS	20	4390	2065	6.546 €
	G16R-259439BC	22,61	4390	2360	9.462 €	G16R-259439BS	22	4390	2265	6.913 €
	G16R-259439CC	24,67	4390	2560	9.815 €	G16R-259439CS	25	4390	2465	7.274 €
G17	G17R-259459AC	21,53	4590	2160	9.405 €	G17R-259459AS	21	4590	2065	6.733 €
	G17R-259459BC	23,68	4590	2360	9.771 €	G17R-259459BS	24	4590	2265	7.111 €
	G17R-259459CC	25,84	4590	2560	10.196 €	G17R-259459CS	26	4590	2465	7.473 €
G18	G18R-259479AC	22,5	4790	2160	9.707 €	G18R-259479AS	22	4790	2065	6.920 €
	G18R-259479BC	24,75	4790	2360	10.086 €	G18R-259479BS	25	4790	2265	7.300 €
	G18R-259479CC	27	4790	2560	10.466 €	G18R-259479CS	27	4790	2465	7.678 €
G19	G19R-259499AC	23,47	4990	2160	10.009 €	G19R-259499AS	23	4990	2065	7.106 €
	G19R-259499BC	25,82	4990	2360	10.396 €	G19R-259499BS	26	4990	2265	7.492 €
	G19R-259499CC	28,17	4990	2560	10.787 €	G19R-259499CS	28	4990	2465	7.878 €

100	Largo - Length (L)																			
	1430	1630	1830	2030	2230	2430	2630	2830	3030	3230	3430	3630	3830	4030	4230	4430	4630	4830	5030	
Fondo - Depth mm 2630	G1	G2	G3	G4	G5	G6	G7	G8	G9	G10	G11	G12	G13	G14	G15	G16	G17	G18	G19	

100	CON suelo - WITH floor panel					SIN suelo - WITHOUT floor panel				
	COD	m²	L	H	€	COD	m²	L	H	€
G1	G1C-263143AC	5,98	1430	2200	4.885 €	G1C-263143AS	5,93	1430	2085	4.106 €
	G1C-263143BC	6,58	1430	2400	5.112 €	G1C-263143BS	6,53	1430	2285	4.331 €
	G1C-263143CC	7,17	1430	2600	5.335 €	G1C-263143CS	7,13	1430	2485	4.556 €
G2	G2C-263163AC	6,95	1630	2200	5.207 €	G2C-263163AS	6,9	1630	2085	4.305 €
	G2C-263163BC	7,64	1630	2400	5.439 €	G2C-263163BS	7,59	1630	2285	4.544 €
	G2C-263163CC	8,34	1630	2600	5.677 €	G2C-263163CS	8,29	1630	2485	4.776 €
G3	G3C-263183AC	7,92	1830	2200	5.522 €	G3C-263183AS	7,86	1830	2085	4.499 €
	G3C-263183BC	8,71	1830	2400	5.773 €	G3C-263183BS	8,65	1830	2285	4.749 €
	G3C-263183CC	9,51	1830	2600	6.018 €	G3C-263183CS	9,45	1830	2485	4.995 €
G4	G4C-263203AC	8,89	2030	2200	5.844 €	G4C-263203AS	8,83	2030	2085	4.698 €
	G4C-263203BC	9,78	2030	2400	6.102 €	G4C-263203BS	9,72	2030	2285	4.956 €
	G4C-263203CC	10,67	2030	2600	6.359 €	G4C-263203CS	10,61	2030	2485	5.214 €
G5	G5C-263223AC	9,87	2230	2200	6.165 €	G5C-263223AS	9,79	2230	2085	4.899 €
	G5C-263223BC	10,85	2230	2400	6.429 €	G5C-263223BS	10,78	2230	2285	5.162 €
	G5C-263223CC	11,84	2230	2600	6.701 €	G5C-263223CS	11,76	2230	2485	5.569 €
G6	G6C-263243AC	10,84	2430	2200	6.481 €	G6C-263243AS	10,76	2430	2085	5.091 €
	G6C-263243BC	11,92	2430	2400	6.764 €	G6C-263243BS	11,84	2430	2285	5.375 €
	G6C-263243CC	13,01	2430	2600	7.043 €	G6C-263243CS	12,92	2430	2485	5.650 €
G7	G7C-263263AC	11,81	2630	2200	6.804 €	G7C-263263AS	12	2630	2085	5.291 €
	G7C-263263BC	12,99	2630	2400	7.093 €	G7C-263263BS	13	2630	2285	5.579 €
	G7C-263263CC	14,17	2630	2600	7.504 €	G7C-263263CS	14	2630	2485	5.870 €
G8	G8C-263283AC	12,78	2830	2200	7.127 €	G8C-263283AS	13	2830	2085	5.484 €
	G8C-263283BC	14,06	2830	2400	7.543 €	G8C-263283BS	14	2830	2285	5.786 €
	G8C-263283CC	15,34	2830	2600	7.846 €	G8C-263283CS	15	2830	2485	6.088 €
G9	G9C-263303AC	13,75	3030	2200	7.564 €	G9C-263303AS	14	3030	2085	5.683 €
	G9C-263303BC	15,13	3030	2400	7.872 €	G9C-263303BS	15	3030	2285	5.992 €
	G9C-263303CC	16,5	3030	2600	8.188 €	G9C-263303CS	16	3030	2485	6.306 €
G10	G10C-263323AC	14,73	3230	2200	7.878 €	G10C-263323AS	15	3230	2085	5.876 €
	G10C-263323BC	16,2	3230	2400	8.207 €	G10C-263323BS	16	3230	2285	6.204 €
	G10C-263323CC	17,67	3230	2600	8.376 €	G10C-263323CS	18	3230	2485	6.528 €
G11	G11C-263343AC	15,7	3430	2200	8.201 €	G11C-263343AS	16	3430	2085	6.075 €
	G11C-263343BC	17,27	3430	2400	8.381 €	G11C-263343BS	17	3430	2285	6.411 €
	G11C-263343CC	18,84	3430	2600	8.708 €	G11C-263343CS	19	3430	2485	6.861 €
G12	G12C-263363AC	16,67	3630	2200	8.366 €	G12C-263363AS	17	3630	2085	6.270 €
	G12C-263363BC	18,34	3630	2400	8.702 €	G12C-263363BS	18	3630	2285	

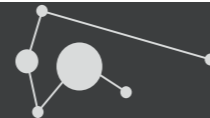

80	Largo - Length (L)																		
	1390	1590	1790	1990	2190	2390	2590	2790	2990	3190	3390	3590	3790	3990	4190	4390	4590	4790	4990
Fondo - Depth mm 2790	H1	H2	H3	H4	H5	H6	H7	H8	H9	H10	H11	H12	H13	H14	H15	H16	H17	H18	H19

80	CON suelo - WITH floor panel					SIN suelo - WITHOUT floor panel				
	COD	m³	L	H	€	COD	m³	L	H	€
H1	H1R-279139AC	6,47	1390	2160	4.738 €	H1R-279139AS	6,42	1390	2065	3.908 €
	H1R-279139BC	7,12	1390	2360	4.962 €	H1R-279139BS	7,07	1390	2265	4.132 €
	H1R-279139CC	7,76	1390	2560	5.181 €	H1R-279139CS	7,72	1390	2465	4.351 €
H2	H2R-279159AC	7,52	1590	2160	5.066 €	H2R-279159AS	7,47	1590	2065	4.100 €
	H2R-279159BC	8,27	1590	2360	5.297 €	H2R-279159BS	8,22	1590	2265	4.331 €
	H2R-279159CC	9,03	1590	2560	5.528 €	H2R-279159CS	8,97	1590	2465	4.564 €
H3	H3R-279179AC	8,57	1790	2160	5.387 €	H3R-279179AS	8,51	1790	2065	4.286 €
	H3R-279179BC	9,43	1790	2360	5.632 €	H3R-279179BS	9,37	1790	2265	4.531 €
	H3R-279179CC	10,29	1790	2560	5.876 €	H3R-279179CS	10,22	1790	2465	4.776 €
H4	H4R-279199AC	9,63	1990	2160	5.716 €	H4R-279199AS	9,55	1990	2065	4.481 €
	H4R-279199BC	10,59	1990	2360	5.966 €	H4R-279199BS	10,52	1990	2265	4.738 €
	H4R-279199CC	11,55	1990	2560	6.217 €	H4R-279199CS	11,48	1990	2465	4.988 €
H5	H5R-279219AC	10,68	2190	2160	6.036 €	H5R-279219AS	10,6	2190	2065	4.672 €
	H5R-279219BC	11,75	2190	2360	6.301 €	H5R-279219BS	11,67	2190	2265	4.938 €
	H5R-279219CC	12,81	2190	2560	6.565 €	H5R-279219CS	12,73	2190	2465	5.201 €
H6	H6R-279239AC	11,73	2390	2160	6.359 €	H6R-279239AS	11,64	2390	2065	4.866 €
	H6R-279239BC	12,9	2390	2360	6.635 €	H6R-279239BS	12,81	2390	2265	5.135 €
	H6R-279239CC	14,08	2390	2560	6.913 €	H6R-279239CS	13,99	2390	2465	5.413 €
H7	H7R-279259AC	12,78	2590	2160	6.688 €	H7R-279259AS	12,69	2590	2065	5.058 €
	H7R-279259BC	14,06	2590	2360	6.971 €	H7R-279259BS	13,96	2590	2265	5.342 €
	H7R-279259CC	15,34	2590	2560	7.260 €	H7R-279259CS	15,24	2590	2465	5.627 €
H8	H8R-279279AC	13,83	2790	2160	7.009 €	H8R-279279AS	14	2790	2065	5.245 €
	H8R-279279BC	15,22	2790	2360	7.305 €	H8R-279279BS	15	2790	2265	5.543 €
	H8R-279279CC	16,6	2790	2560	7.602 €	H8R-279279CS	17	2790	2465	5.839 €
H9	H9R-279299AC	14,89	2990	2160	7.337 €	H9R-279299AS	15	2990	2065	5.439 €
	H9R-279299BC	16,37	2990	2360	7.640 €	H9R-279299BS	16	2990	2265	5.741 €
	H9R-279299CC	17,86	2990	2560	7.910 €	H9R-279299CS	18	2990	2465	6.049 €
H10	H10R-279319AC	15,94	3190	2160	7.659 €	H10R-279319AS	16	3190	2065	5.632 €
	H10R-279319BC	17,53	3190	2360	7.944 €	H10R-279319BS	18	3190	2265	5.947 €
	H10R-279319CC	19,13	3190	2560	8.252 €	H10R-279319CS	19	3190	2465	6.262 €
H11	H11R-279339AC	16,99	3390	2160	7.949 €	H11R-279339AS	17	3390	2065	5.825 €
	H11R-279339BC	18,69	3390	2360	8.272 €	H11R-279339BS	19	3390	2265	6.147 €
	H11R-279339CC	20,39	3390	2560	8.588 €	H11R-279339CS	20	3390	2465	6.474 €
H12	H12R-279359AC	18,04	3590	2160	8.264 €	H12R-279359AS	18	3590	2065	6.012 €
	H12R-279359BC	19,85	3590	2360	8.598 €	H12R-279359BS	20	3590	2265	6.354 €
	H12R-279359CC	21,65	3590	2560	8.928 €	H12R-279359CS	22	3590	2465	6.688 €
H13	H13R-279379AC	19,09	3790	2160	8.588 €	H13R-279379AS	19	3790	2065	6.204 €
	H13R-279379BC	21	3790	2360	8.920 €	H13R-279379BS	21	3790	2265	6.551 €
	H13R-279379CC	22,91	3790	2560	9.262 €	H13R-279379CS	23	3790	2465	6.900 €
H14	H14R-279399AC	20,15	3990	2160	8.902 €	H14R-279399AS	20	3990	2065	6.399 €
	H14R-279399BC	22,16	3990	2360	9.250 €	H14R-279399BS	22	3990	2265	6.752 €
	H14R-279399CC	24,17	3990	2560	9.604 €	H14R-279399CS	24	3990	2465	7.106 €
H15	H15R-279419AC	21,2	4190	2160	9.217 €	H15R-279419AS	21	4190	2065	6.591 €
	H15R-279419BC	23,32	4190	2360	9.578 €	H15R-279419BS	23	4190	2265	6.959 €
	H15R-279419CC	25,44	4190	2560	9.938 €	H15R-279419CS	25	4190	2465	7.313 €
H16	H16R-279439AC	22,25	4390	2160	9.538 €	H16R-279439AS	22	4390	2065	6.777 €
	H16R-279439BC	24,47	4390	2360	9.906 €	H16R-279439BS	24	4390	2265	7.150 €
	H16R-279439CC	26,7	4390	2560	10.273 €	H16R-279439CS	27	4390	2465	7.524 €
H17	H17R-279459AC	23,3	4590	2160	9.854 €	H17R-279459AS	23	4590	2065	6.971 €
	H17R-279459BC	25,63	4590	2360	10.235 €	H17R-279459BS	26	4590	2265	7.351 €
	H17R-279459CC	27,96	4590	2560	10.614 €	H17R-279459CS	28	4590	2465	7.731 €
H18	H18R-279479AC	24,35	4790	2160	10.169 €	H18R-279479AS	24	4790	2065	7.163 €
	H18R-279479BC	26,79	4790	2360	10.563 €	H18R-279479BS	27	4790	2265	7.543 €
	H18R-279479CC	29,22	4790	2560	10.949 €	H18R-279479CS	29	4790	2465	7.936 €
H19	H19R-279499AC	25,41	4990	2160	10.485 €	H19R-279499AS	25	4990	2065	7.344 €
	H19R-279499BC	27,95	4990	2360	10.884 €	H19R-279499BS	28	4990	2265	7.744 €
	H19R-279499CC	30,49	4990	2560	11.292 €	H19R-279499CS	30	4990	2465	8.141 €

100	Largo - Length (L)																		
	1430	1630	1830	2030	2230	2430	2630	2830	3030	3230	3430	3630	3830	4030	4230	4430	4630	4830	5030
Fondo - Depth mm 2830	H1	H2	H3	H4	H5	H6	H7	H8	H9	H10	H11	H12	H13	H14	H15	H16	H17	H18	H19

100	CON suelo - WITH floor panel					SIN suelo - WITHOUT floor panel				
	COD	m³	L	H	€	COD	m³	L	H	€
H1	H1C-283143AC	6,47	1430	2200	5.112 €	H1C-283143AS	6,42	1430	2085	4.273 €
	H1C-283143BC	7,12	1430	2400	5.348 €	H1C-283143BS	7,07	1430	2285	4.504 €
	H1C-283143CC	7,76	1430	2600	5.579 €	H1C-283143CS	7,72	1430	2485	4.743 €
H2	H2C-283163AC	7,52	1630	2200	5.445 €	H2C-283163AS	7,47	1630	2085	4.473 €
	H2C-283163BC	8,27	1630	2400	5.696 €	H2C-283163BS	8,22	1630	2285	4.717 €
	H2C-283163CC	9,03	1630	2600	5.942 €	H2C-283163CS	8,97	1630	2485	4.969 €
H3	H3C-283183AC	8,57	1830	2200	5.780 €	H3C-283183AS	8,51	1830	2085	4.680 €
	H3C-283183BC	9,43	1830	2400	6.036 €	H3C-283183BS	9,37	1830	2285	4.938 €
	H3C-283183CC	10,29	1830	2600	6.295 €	H3C-283183CS	10,22	1830	2485	5.196 €
H4	H4C-283203AC	9,63	2030	2200	6.120 €	H4C-283203AS	9,55	2030	2085	4.879 €
	H4C-283203BC	10,59	2030	2400	6.385 €	H4C-283203BS	10,52	2030	2285	5.149 €
	H4C-283203CC	11,55	2030	2600	6.656 €	H4C-283203CS	11,48	2030	2485	5.419 €
H5	H5C-283223AC	10,68	2230	2200	6.456 €	H5C-283223AS	10,6	2230	2085	5.078 €
	H5C-283223BC	11,75	2230	2400	6.733 €	H5C-283223BS	11,67	2230	2285	5.361 €
	H5C-283223CC	12,81	2230	2600	7.009 €	H5C-283223CS	12,73	2230	2485	5.639 €
H6	H6C-283243AC	11,73	2430	2200	6.791 €	H6C-283243AS	11,64	2430	2085	5.285 €
	H6C-283243BC	12,9	2430	2400	7.079 €	H6C-283243BS	12,81	2430	2285	5.573 €
	H6C-283243CC	14,08	2430	2600	7.486 €	H6C-283243CS	13,99	2430	2485	5.863 €
H7	H7C-283263AC	12,78	2630	2200	7.127 €	H7C-283263AS	12,69	2630	2085	5.484 €
	H7C-283263BC	14,06	2630	2400	7.543 €	H7C-283263BS	13,96	2630	2285	5.786 €
	H7C-283263CC	15,34	2630	2600	7.846 €	H7C-283263CS	15,24	2630	2485	6.088 €
H8	H8C-283283AC	13,83	2830	2200	7.575 €	H8C-283283AS	14	2830	2085	5.690 €
	H8C-283283BC	15,22	2830	2400	7.890 €	H8C-283283BS	15	2830	2285	5.999 €
	H8C-283283CC	16,6	2830	2600	8.201 €	H8C-283283CS	17	2830	2485	6.315 €
H9	H9C-283303AC	14,89	3030	2200	7.910 €	H9C-283303AS	15	3030	2085	5.889 €
	H9C-283303BC	16,37	3030	2400	8.238 €	H9C-283303BS	16	3030	2285	6.212 €
	H9C-283303CC	17,86	3030	2600	8.405 €	H9C-283303CS	18	3030	2485	6.539 €
H10	H10C-283323AC	15,94	3230	2200	8.245 €	H10C-283323AS	16	3230		

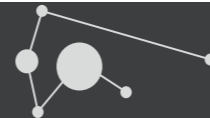

80	Largo - Length (L)																		
	1390	1590	1790	1990	2190	2390	2590	2790	2990	3190	3390	3590	3790	3990	4190	4390	4590	4790	4990
Fondo - Depth mm 2990	J1	J2	J3	J4	J5	J6	J7	J8	J9	J10	J11	J12	J13	J14	J15	J16	J17	J18	J19

80	CON suelo - WITH floor panel					SIN suelo - WITHOUT floor panel				
	COD	m³	L	H	€	COD	m³	L	H	€
J1	J1R-299139AC	6,96	1390	2160	4.956 €	J1R-299139AS	6,91	1390	2065	4.061 €
	J1R-299139BC	7,66	1390	2360	5.188 €	J1R-299139BS	7,61	1390	2265	4.295 €
	J1R-299139CC	8,35	1390	2560	5.419 €	J1R-299139CS	8,3	1390	2465	4.531 €
J2	J2R-299159AC	8,09	1590	2160	5.297 €	J2R-299159AS	8,03	1590	2065	4.261 €
	J2R-299159BC	8,9	1590	2360	5.543 €	J2R-299159BS	8,84	1590	2265	4.499 €
	J2R-299159CC	9,71	1590	2560	5.780 €	J2R-299159CS	9,65	1590	2465	4.743 €
J3	J3R-299179AC	9,23	1790	2160	5.639 €	J3R-299179AS	9,16	1790	2065	4.454 €
	J3R-299179BC	10,15	1790	2360	5.889 €	J3R-299179BS	10,08	1790	2265	4.711 €
	J3R-299179CC	11,07	1790	2560	6.141 €	J3R-299179CS	11	1790	2465	4.962 €
J4	J4R-299199AC	10,36	1990	2160	5.973 €	J4R-299199AS	10,28	1990	2065	4.654 €
	J4R-299199BC	11,39	1990	2360	6.243 €	J4R-299199BS	11,32	1990	2265	4.918 €
	J4R-299199CC	12,43	1990	2560	6.501 €	J4R-299199CS	12,35	1990	2465	5.181 €
J5	J5R-299219AC	11,49	2190	2160	6.315 €	J5R-299219AS	11,4	2190	2065	4.846 €
	J5R-299219BC	12,64	2190	2360	6.591 €	J5R-299219BS	12,55	2190	2265	5.125 €
	J5R-299219CC	13,79	2190	2560	6.867 €	J5R-299219CS	13,7	2190	2465	5.400 €
J6	J6R-299239AC	12,62	2390	2160	6.656 €	J6R-299239AS	12,53	2390	2065	5.046 €
	J6R-299239BC	13,88	2390	2360	6.938 €	J6R-299239BS	13,79	2390	2265	5.329 €
	J6R-299239CC	15,15	2390	2560	7.229 €	J6R-299239CS	15,05	2390	2465	5.612 €
J7	J7R-299259AC	13,75	2590	2160	6.996 €	J7R-299259AS	13,65	2590	2065	5.240 €
	J7R-299259BC	15,13	2590	2360	7.292 €	J7R-299259BS	15,03	2590	2265	5.534 €
	J7R-299259CC	16,5	2590	2560	7.589 €	J7R-299259CS	16,4	2590	2465	5.830 €
J8	J8R-299279AC	14,89	2790	2160	7.337 €	J8R-299279AS	14,77	2790	2065	5.439 €
	J8R-299279BC	16,37	2790	2360	7.640 €	J8R-299279BS	16,26	2790	2265	5.741 €
	J8R-299279CC	17,86	2790	2560	7.910 €	J8R-299279CS	17,75	2790	2465	6.049 €
J9	J9R-299299AC	16,02	2990	2160	7.918 €	J9R-299299AS	16	2990	2065	5.876 €
	J9R-299299BC	17,62	2990	2360	8.201 €	J9R-299299BS	18	2990	2265	6.192 €
	J9R-299299CC	19,22	2990	2560	8.509 €	J9R-299299CS	19	2990	2465	6.507 €
J10	J10R-299319AC	17,15	3190	2160	8.238 €	J10R-299319AS	17	3190	2065	6.088 €
	J10R-299319BC	18,86	3190	2360	8.561 €	J10R-299319BS	19	3190	2265	6.418 €
	J10R-299319CC	20,58	3190	2560	8.876 €	J10R-299319CS	20	3190	2465	6.745 €
J11	J11R-299339AC	18,28	3390	2160	8.588 €	J11R-299339AS	18	3390	2065	6.306 €
	J11R-299339BC	20,11	3390	2360	8.920 €	J11R-299339BS	20	3390	2265	6.641 €
	J11R-299339CC	21,94	3390	2560	9.250 €	J11R-299339CS	22	3390	2465	6.976 €
J12	J12R-299359AC	19,41	3590	2160	8.934 €	J12R-299359AS	19	3590	2065	6.519 €
	J12R-299359BC	21,36	3590	2360	9.277 €	J12R-299359BS	21	3590	2265	6.867 €
	J12R-299359CC	23,3	3590	2560	9.617 €	J12R-299359CS	23	3590	2465	7.216 €
J13	J13R-299379AC	20,55	3790	2160	9.288 €	J13R-299379AS	20	3790	2065	6.733 €
	J13R-299379BC	22,6	3790	2360	9.636 €	J13R-299379BS	22	3790	2265	7.093 €
	J13R-299379CC	24,65	3790	2560	9.984 €	J13R-299379CS	25	3790	2465	7.442 €
J14	J14R-299399AC	21,68	3990	2160	9.636 €	J14R-299399AS	22	3990	2065	6.945 €
	J14R-299399BC	23,85	3990	2360	9.995 €	J14R-299399BS	24	3990	2265	7.313 €
	J14R-299399CC	26,01	3990	2560	10.357 €	J14R-299399CS	26	3990	2465	7.673 €
J15	J15R-299419AC	22,81	4190	2160	9.984 €	J15R-299419AS	23	4190	2065	7.158 €
	J15R-299419BC	25,09	4190	2360	10.357 €	J15R-299419BS	25	4190	2265	7.531 €
	J15R-299419CC	27,37	4190	2560	10.722 €	J15R-299419CS	27	4190	2465	7.905 €
J16	J16R-299439AC	23,94	4390	2160	10.329 €	J16R-299439AS	24	4390	2065	7.376 €
	J16R-299439BC	26,34	4390	2360	10.711 €	J16R-299439BS	26	4390	2265	7.750 €
	J16R-299439CC	28,73	4390	2560	11.091 €	J16R-299439CS	29	4390	2465	8.130 €
J17	J17R-299459AC	25,07	4590	2160	10.683 €	J17R-299459AS	25	4590	2065	7.582 €
	J17R-299459BC	27,58	4590	2360	11.070 €	J17R-299459BS	27	4590	2265	7.967 €
	J17R-299459CC	30,09	4590	2560	11.464 €	J17R-299459CS	30	4590	2465	8.361 €
J18	J18R-299479AC	26,21	4790	2160	11.032 €	J18R-299479AS	26	4790	2065	7.788 €
	J18R-299479BC	28,83	4790	2360	11.430 €	J18R-299479BS	29	4790	2265	8.193 €
	J18R-299479CC	31,45	4790	2560	11.829 €	J18R-299479CS	31	4790	2465	8.593 €
J19	J19R-299499AC	27,34	4990	2160	11.381 €	J19R-299499AS	27	4990	2065	8.001 €
	J19R-299499BC	30,07	4990	2360	11.793 €	J19R-299499BS	30	4990	2265	8.413 €
	J19R-299499CC	32,81	4990	2560	12.205 €	J19R-299499CS	33	4990	2465	8.819 €

100	Largo - Length (L)																		
	1430	1630	1830	2030	2230	2430	2630	2830	3030	3230	3430	3630	3830	4030	4230	4430	4630	4830	5030
Fondo - Depth mm 3030	H1	H2	H3	H4	H5	H6	H7	H8	H9	H10	H11	H12	H13	H14	H15	H16	H17	H18	H19

100	CON suelo - WITH floor panel					SIN suelo - WITHOUT floor panel				
	COD	m³	L	H	€	COD	m³	L	H	€
J1	J1C-303143AC	6,96	1430	2200	5.335 €	J1C-303143AS	6,91	1430	2085	4.433 €
	J1C-303143BC	7,66	1430	2400	5.588 €	J1C-303143BS	7,61	1430	2285	4.687 €
	J1C-303143CC	8,35	1430	2600	5.830 €	J1C-303143CS	8,3	1430	2485	4.929 €
J2	J2C-303163AC	8,09	1630	2200	5.690 €	J2C-303163AS	8,03	1630	2085	4.648 €
	J2C-303163BC	8,9	1630	2400	5.947 €	J2C-303163BS	8,84	1630	2285	4.904 €
	J2C-303163CC	9,71	1630	2600	6.204 €	J2C-303163CS	9,65	1630	2485	5.162 €
J3	J3C-303183AC	9,23	1830	2200	6.036 €	J3C-303183AS	9,16	1830	2085	4.854 €
	J3C-303183BC	10,15	1830	2400	6.306 €	J3C-303183BS	10,08	1830	2285	5.117 €
	J3C-303183CC	11,07	1830	2600	6.578 €	J3C-303183CS	11	1830	2485	5.387 €
J4	J4C-303203AC	10,36	2030	2200	6.390 €	J4C-303203AS	10,28	2030	2085	5.058 €
	J4C-303203BC	11,39	2030	2400	6.669 €	J4C-303203BS	11,32	2030	2285	5.342 €
	J4C-303203CC	12,43	2030	2600	6.950 €	J4C-303203CS	12,35	2030	2485	5.617 €
J5	J5C-303223AC	11,49	2230	2200	6.745 €	J5C-303223AS	11,4	2230	2085	5.263 €
	J5C-303223BC	12,64	2230	2400	7.034 €	J5C-303223BS	12,55	2230	2285	5.555 €
	J5C-303223CC	13,79	2230	2600	7.442 €	J5C-303223CS	13,7	2230	2485	5.850 €
J6	J6C-303243AC	12,62	2430	2200	7.093 €	J6C-303243AS	12,53	2430	2085	5.476 €
	J6C-303243BC	13,88	2430	2400	7.512 €	J6C-303243BS	13,79	2430	2285	5.773 €
	J6C-303243CC	15,15	2430	2600	7.815 €	J6C-303243CS	15,05	2430	2485	6.075 €
J7	J7C-303263AC	13,75	2630	2200	7.564 €	J7C-303263AS	13,65	2630	2085	5.683 €
	J7C-303263BC	15,13	2630	2400	7.872 €	J7C-303263BS	15,03	2630	2285	5.992 €
	J7C-303263CC	16,5	2630	2600	8.188 €	J7C-303263CS	16,4	2630	2485	6.306 €
J8	J8C-303283AC	14,89	2830	2200	7.910 €	J8C-303283AS	14,77	2830	2085	5.889 €
	J8C-303283BC	16,37	2830	2400	8.238 €	J8C-303283BS	16,26	2830	2285	6.212 €
	J8C-303283CC	17,86	2830	2600	8.405 €	J8C-303283CS	17,75	2830	2485	6.539 €
J9	J9C-303303AC	16,02	3030	2200	8.504 €	J9C-303303AS	16	3030	2085	6.340 €
	J9C-303303BC	17,62	3030	2400	8.682 €	J9C-303303BS	18	3030	2285	6.674 €
	J9C-303303CC	19,22	3030	2600	9.010 €	J9C-303303CS	19	3030	2485	7.127 €
J10	J10C-303323AC	17,15	3230	2200	8.716 €	J10C-303323AS	17	3230	2085	6.565 €
	J10C-303323BC	18,86	3230	2400	9.050 €	J10C-303323BS	19	3230	2285	6.905 €
	J10C-303323CC	20,58	3230	2600	9.390 €	J10C-303323CS	20	3230	2485	7.369 €
J11	J11C-303343AC	18,28	3430	2200	9.075 €	J11C-303343AS	18	3430	2085	6.791 €
	J11C-303343BC	20,11	3430	2400	9.423 €	J11C-303343BS	20	3430	2285	7.260 €
	J11C-303343CC	21,94	3430	2600	9.771 €	J11C-303343CS	22	3430	2485	7.620 €
J12	J12C-303363AC	19,41	3630	2200	9.437 €	J12C-303363AS	19	3630	2085	7.016 €
	J12C-303363BC	21,36	3630							



80	Largo - Length (L)																		
	1390	1590	1790	1990	2190	2390	2590	2790	2990	3190	3390	3590	3790	3990	4190	4390	4590	4790	4990
Fondo - Depth mm 3190	K1	K2	K3	K4	K5	K6	K7	K8	K9	K10	K11	K12	K13	K14	K15	K16	K17	K18	K19

80	CON suelo - WITH floor panel					SIN suelo - WITHOUT floor panel				
	COD	m³	L	H	€	COD	m³	L	H	€
K1	K1R-319139AC	7,45	1390	2160	5.174 €	K1R-319139AS	7,4	1390	2065	4.216 €
	K1R-319139BC	8,2	1390	2360	5.419 €	K1R-319139BS	8,14	1390	2265	4.460 €
	K1R-319139CC	8,94	1390	2560	5.663 €	K1R-319139CS	8,89	1390	2465	4.704 €
K2	K2R-319159AC	8,67	1590	2160	5.528 €	K2R-319159AS	8,6	1590	2065	4.423 €
	K2R-319159BC	9,53	1590	2360	5.780 €	K2R-319159BS	9,47	1590	2265	4.672 €
	K2R-319159CC	10,4	1590	2560	6.036 €	K2R-319159CS	10,33	1590	2465	4.924 €
K3	K3R-319179AC	9,88	1790	2160	5.883 €	K3R-319179AS	9,8	1790	2065	4.620 €
	K3R-319179BC	10,87	1790	2360	6.147 €	K3R-319179BS	10,79	1790	2265	4.885 €
	K3R-319179CC	11,85	1790	2560	6.411 €	K3R-319179CS	11,78	1790	2465	5.149 €
K4	K4R-319199AC	11,09	1990	2160	6.236 €	K4R-319199AS	11,01	1990	2065	4.820 €
	K4R-319199BC	12,2	1990	2360	6.513 €	K4R-319199BS	12,12	1990	2265	5.097 €
	K4R-319199CC	13,31	1990	2560	6.791 €	K4R-319199CS	13,22	1990	2465	5.375 €
K5	K5R-319219AC	12,3	2190	2160	6.596 €	K5R-319219AS	12,21	2190	2065	5.027 €
	K5R-319219BC	13,53	2190	2360	6.881 €	K5R-319219BS	13,44	2190	2265	5.310 €
	K5R-319219CC	14,76	2190	2560	7.163 €	K5R-319219CS	14,67	2190	2465	5.593 €
K6	K6R-319239AC	13,51	2390	2160	6.950 €	K6R-319239AS	13,41	2390	2065	5.225 €
	K6R-319239BC	14,87	2390	2360	7.247 €	K6R-319239BS	14,76	2390	2265	5.522 €
	K6R-319239CC	16,22	2390	2560	7.543 €	K6R-319239CS	16,12	2390	2465	5.819 €
K7	K7R-319259AC	14,73	2590	2160	7.305 €	K7R-319259AS	14,62	2590	2065	5.427 €
	K7R-319259BC	16,2	2590	2360	7.608 €	K7R-319259BS	16,09	2590	2265	5.734 €
	K7R-319259CC	17,67	2590	2560	7.884 €	K7R-319259CS	17,56	2590	2465	6.036 €
K8	K8R-319279AC	15,94	2790	2160	7.659 €	K8R-319279AS	15,82	2790	2065	5.632 €
	K8R-319279BC	17,53	2790	2360	7.944 €	K8R-319279BS	17,41	2790	2265	5.947 €
	K8R-319279CC	19,13	2790	2560	8.252 €	K8R-319279CS	19,01	2790	2465	6.262 €
K9	K9R-319299AC	17,15	2990	2160	8.238 €	K9R-319299AS	17,02	2990	2065	6.088 €
	K9R-319299BC	18,86	2990	2360	8.561 €	K9R-319299BS	18,74	2990	2265	6.418 €
	K9R-319299CC	20,58	2990	2560	8.876 €	K9R-319299CS	20,45	2990	2465	6.745 €
K10	K10R-319319AC	18,36	3190	2160	8.588 €	K10R-319319AS	18	3190	2065	6.295 €
	K10R-319319BC	20,2	3190	2360	8.913 €	K10R-319319BS	20	3190	2265	6.630 €
	K10R-319319CC	22,03	3190	2560	9.243 €	K10R-319319CS	22	3190	2465	6.971 €
K11	K11R-319339AC	19,57	3390	2160	8.947 €	K11R-319339AS	19	3390	2065	6.513 €
	K11R-319339BC	21,53	3390	2360	9.288 €	K11R-319339BS	21	3390	2265	6.861 €
	K11R-319339CC	23,49	3390	2560	9.630 €	K11R-319339CS	23	3390	2465	7.208 €
K12	K12R-319359AC	20,79	3590	2160	9.315 €	K12R-319359AS	21	3590	2065	6.733 €
	K12R-319359BC	22,86	3590	2360	9.661 €	K12R-319359BS	23	3590	2265	7.088 €
	K12R-319359CC	24,94	3590	2560	10.014 €	K12R-319359CS	25	3590	2465	7.442 €
K13	K13R-319379AC	22	3790	2160	9.680 €	K13R-319379AS	22	3790	2065	6.950 €
	K13R-319379BC	24,2	3790	2360	10.041 €	K13R-319379BS	24	3790	2265	7.319 €
	K13R-319379CC	26,4	3790	2560	10.396 €	K13R-319379CS	26	3790	2465	7.673 €
K14	K14R-319399AC	23,21	3990	2160	10.041 €	K14R-319399AS	23	3990	2065	7.171 €
	K14R-319399BC	25,53	3990	2360	10.413 €	K14R-319399BS	25	3990	2265	7.536 €
	K14R-319399CC	27,85	3990	2560	10.782 €	K14R-319399CS	28	3990	2465	7.910 €
K15	K15R-319419AC	24,42	4190	2160	10.408 €	K15R-319419AS	24	4190	2065	7.390 €
	K15R-319419BC	26,86	4190	2360	10.787 €	K15R-319419BS	27	4190	2265	7.762 €
	K15R-319419CC	29,31	4190	2560	11.169 €	K15R-319419CS	29	4190	2465	8.141 €
K16	K16R-319439AC	25,63	4390	2160	10.767 €	K16R-319439AS	25	4390	2065	7.602 €
	K16R-319439BC	28,2	4390	2360	11.160 €	K16R-319439BS	28	4390	2265	7.989 €
	K16R-319439CC	30,76	4390	2560	11.553 €	K16R-319439CS	31	4390	2465	8.381 €
K17	K17R-319459AC	26,85	4590	2160	11.136 €	K17R-319459AS	27	4590	2065	7.815 €
	K17R-319459BC	29,53	4590	2360	11.534 €	K17R-319459BS	29	4590	2265	8.212 €
	K17R-319459CC	32,21	4590	2560	11.933 €	K17R-319459CS	32	4590	2465	8.612 €
K18	K18R-319479AC	28,06	4790	2160	11.495 €	K18R-319479AS	28	4790	2065	8.027 €
	K18R-319479BC	30,86	4790	2360	11.907 €	K18R-319479BS	31	4790	2265	8.438 €
	K18R-319479CC	33,67	4790	2560	12.321 €	K18R-319479CS	33	4790	2465	8.850 €
K19	K19R-319499AC	29,27	4990	2160	11.862 €	K19R-319499AS	29	4990	2065	8.245 €
	K19R-319499BC	32,2	4990	2360	12.332 €	K19R-319499BS	32	4990	2265	8.663 €
	K19R-319499CC	35,12	4990	2560	12.812 €	K19R-319499CS	35	4990	2465	9.083 €

100	Largo - Length (L)																		
	1430	1630	1830	2030	2230	2430	2630	2830	3030	3230	3430	3630	3830	4030	4230	4430	4630	4830	5030
Fondo - Depth mm 3230	K1	K2	K3	K4	K5	K6	K7	K8	K9	K10	K11	K12	K13	K14	K15	K16	K17	K18	K19

100	CON suelo - WITH floor panel					SIN suelo - WITHOUT floor panel				
	COD	m³	L	H	€	COD	m³	L	H	€
K1	K1C-323143AC	7,45	1430	2200	5.568 €	K1C-323143AS	7,4	1430	2085	4.602 €
	K1C-323143BC	8,2	1430	2400	5.825 €	K1C-323143BS	8,14	1430	2285	4.860 €
	K1C-323143CC	8,94	1430	2600	6.083 €	K1C-323143CS	8,89	1430	2485	5.117 €
K2	K2C-323163AC	8,67	1630	2200	5.928 €	K2C-323163AS	8,6	1630	2085	4.815 €
	K2C-323163BC	9,53	1630	2400	6.198 €	K2C-323163BS	9,47	1630	2285	5.085 €
	K2C-323163CC	10,4	1630	2600	6.469 €	K2C-323163CS	10,33	1630	2485	5.348 €
K3	K3C-323183AC	9,88	1830	2200	6.295 €	K3C-323183AS	9,8	1830	2085	5.027 €
	K3C-323183BC	10,87	1830	2400	6.578 €	K3C-323183BS	10,79	1830	2285	5.303 €
	K3C-323183CC	11,85	1830	2600	6.856 €	K3C-323183CS	11,78	1830	2485	5.588 €
K4	K4C-323203AC	11,09	2030	2200	6.662 €	K4C-323203AS	11,01	2030	2085	5.240 €
	K4C-323203BC	12,2	2030	2400	6.959 €	K4C-323203BS	12,12	2030	2285	5.528 €
	K4C-323203CC	13,31	2030	2600	7.363 €	K4C-323203CS	13,22	2030	2485	5.819 €
K5	K5C-323223AC	12,3	2230	2200	7.028 €	K5C-323223AS	12,21	2230	2085	5.451 €
	K5C-323223BC	13,53	2230	2400	7.447 €	K5C-323223BS	13,44	2230	2285	5.755 €
	K5C-323223CC	14,76	2230	2600	7.750 €	K5C-323223CS	14,67	2230	2485	6.057 €
K6	K6C-323243AC	13,51	2430	2200	7.518 €	K6C-323243AS	13,41	2430	2085	5.663 €
	K6C-323243BC	14,87	2430	2400	7.826 €	K6C-323243BS	14,76	2430	2285	5.980 €
	K6C-323243CC	16,22	2430	2600	8.141 €	K6C-323243CS	16,12	2430	2485	6.287 €
K7	K7C-323263AC	14,73	2630	2200	7.878 €	K7C-323263AS	14,62	2630	2085	5.876 €
	K7C-323263BC	16,2	2630	2400	8.207 €	K7C-323263BS	16,09	2630	2285	6.204 €
	K7C-323263CC	17,67	2630	2600	8.376 €	K7C-323263CS	17,56	2630	2485	6.528 €
K8	K8C-323283AC	15,94	2830	2200	8.245 €	K8C-323283AS	15,82	2830	2085	6.097 €
	K8C-323283BC	17,53	2830	2400	8.425 €	K8C-323283BS	17,41	2830	2285	6.423 €
	K8C-323283CC	19,13	2830	2600	8.753 €	K8C-323283CS	19,01	2830	2485	6.881 €
K9	K9C-323303AC	17,15	3030	2200	8.716 €	K9C-323303AS	17,02	3030	2085	6.565 €
	K9C-323303BC	18,86	3030	2400	9.050 €	K9C-323303BS	18,74	3030	2285	6.905 €
	K9C-323303CC	20,58	3030	2600	9.390 €	K9C-323303CS	20,45	3030	2485	7.369 €
K10	K10C-323323AC	18,36	3230	2200	9.075 €	K10C-323323AS	18	3230	2085	6.777 €
	K10C-323323BC	20,2	3230	2400	9.423 €	K10C-323323BS	20	3230	2285	7.254 €
	K10C-323323CC	22,03	3230	2600	9.771 €	K10C-323323CS	22	3230	2485	7.608 €
K11	K11C-323343AC	19,57	3430	2200	9.449 €	K11C-323343AS	19	3430	2085	7.009 €
	K11C-323343BC	21,53	3430	2400	9.809 €	K11C-323343BS	21	3430	2285	7.492 €
	K11C-323343CC	23,49	3430	2600	10.169 €	K11C-323343CS	23	3430	2485	7.859 €
K12	K12C-323363AC	20,79	3630	2200	9.821 €	K12C-323363AS	21	3630	2085	7.358 €
	K12C-32336									

Serie RFM-PC

2

MÓDULOS RFM CON PUERTAS DE CRISTAL
RFM MODULES WITH GLASS DOORS



CORECO

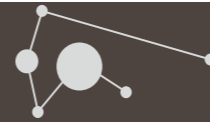

Estanterías NO incluidas
Shelves NOT included

Mecanismo de ganchos excéntricos de doble efecto (gira y recoge)

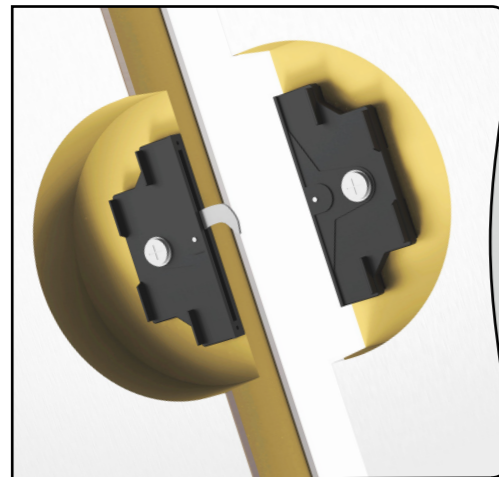

Double effect eccentric hooks mechanism (turns and locks)

Aislamiento:

- Espuma rígida de poliuretano con formulación libre de CFC e inyectado a alta presión
- Densidad 45 Kg. / m²
- Coeficiente de conductividad térmica 0.022W/mK a 10°C. (Sin envejecimiento)

Insulation:

- Rigid polyurethane foam, CFC-free, injected at high pressure.
- Density 45kg/m².
- Thermal conductivity coefficient 0.022W/mK at 10°C. (Without ageing).

Paneles

- Dos espesores: 80 y 100 mm.

Panels

- Two thickness: 80 and 100 mm.

Características técnicas y constructivas sujetas a variación sin previo aviso.

We reserve the right to change specifications without prior notice.

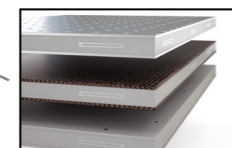
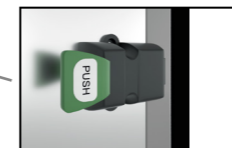
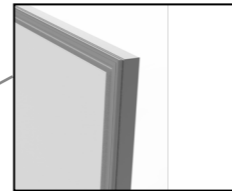
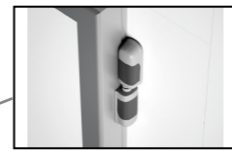

Revestimiento:

- Revestimiento estándar de chapa de acero galvanizado prelacado poliéster, con film de protección pelable.
- Color blanco pirineo.
- Calidad alimentaria.

Cladding:

- Galvanized steel cladding pre-lacquered with polyester, with peelable protective film, as standard.
- Colour white, "blanco pirineo".
- Food grade.

Sistema de Unión:

- Mecanismo de ganchos excéntricos de alta resistencia y doble efecto (gira y recoge), colocados en carcasas de ABS. El conjunto está pensado para trabajar de dos maneras: engancha y puede ser enganchado.

Connecting System:

- High resistance and double effect eccentric hooks mechanism (turns and locks), installed in ABS housings. The combination is designed to work in two ways: it engages and can be hooked.

Columnas verticales y horizontales:

- Columnas perimetrales que incluyen un innovador perfil sanitario con labio flexible que se adapta al panel consiguiendo una unión perfecta de gran calidad y revestidas en su exterior con la misma chapa utilizada en los paneles, consiguiendo así una línea estética regular en toda la cámara.
- Todo el conjunto está inyectado en su interior con poliuretano de las mismas características y densidad que el resto de paneles.

Vertical and horizontal columns:

- Perimeter columns with innovative flexible sanitary lip seal that adapts to fit the panel, combining high quality and an exterior coating made with the same metal sheeting as used to make the panels, thus achieving a uniform appearance throughout the room.
- Everything is injected with polyurethane and has the same characteristics and density as the rest of the panels.

Puerta ciega

- Marco perimetral exterior de aluminio anodizado anticorrosión
- Burlete de estanqueidad.
- Hueco de luz 1850x800 mm
- Resistencia eléctrica antiescarcha colocada en el marco del panel de puerta.
- Tanto el panel puerta como la puerta están inyectados en su interior con el mismo aislamiento del resto de paneles.
- Bisagras con regulación y pasador inoxidable.
- Cierre con llave y con punto de presión.

Solid door:

- Exterior perimeter frame made of anodized anti-corrosion aluminium.
- Sealing gasket.
- A light shaft of 1850x800 mm.
- Frost prevention electric resistance placed on door panel frame.
- Both the door panel and the door are injected with the same insulation as the rest of the panels.
- Adjustable hinges with stainless steel pin.
- Locks with key and pressure point.

Puerta cristal

- Marco perimetral exterior de aluminio anodizado anticorrosión color plata.
- Burlete magnético de estanqueidad.
- Hueco de luz 1700x610mm en puerta
- Doble cristal en temperatura positiva: exterior 4mm templado, separador 20mm, interior 4mm bajo emisivo, Ug 1,1 W/(m².K)
- Triple cristal en temperatura negativa: exterior 4mm templado bajo emisivo, separador 8mm, central 4mm, separador 8mm, interior 4mm bajo emisivo, Ug 0,9 W/(m².K)
- Apertura a derechas (apertura a izquierda bajo pedido)
- Cristales calefactados en temperatura negativa
- Soporte de puertas en acero inoxidable.
- Tirador superpuesto.
- Muelle de retorno automático, con fuerza de retorno ajustable.

Glass door:

- Perimetral exterior frame, made of aluminium and anodized anti-corrosion, silver colour
- Magnetic sealing gasket.
- Light shaft of 1700x610 mm in door.
- Double glazed positive temperatures: exterior tempered glass 4mm, gas 20mm, interior low-e glass 4mm, Ug 1,1 W/(m².K)
- Triple glazed negative temperatures: exterior low-e tempered glass 4mm, gas 8mm, central clear glass 4mm, gas 8mm, interior low-e glass 4mm, Ug 0,9 W/(m².K)
- Right opening (optional: left opening)
- Heated glass negative temperature
- Stainless steel door support.
- Superimposed handle.
- Adjustable automatic return spring

Marco

- Marco perimetral exterior de aluminio y PVC anodizado anticorrosión color plata
- Resistencia en el perímetro.

Frame

- Perimetral exterior frame, made of aluminium and anodized anti-corrosion PVC, silver colour
- Frame heating resistance

Iluminación

- LED

Lighting

- LED

Características técnicas y constructivas sujetas a variación sin previo aviso.

We reserve the right to change specifications without prior notice.

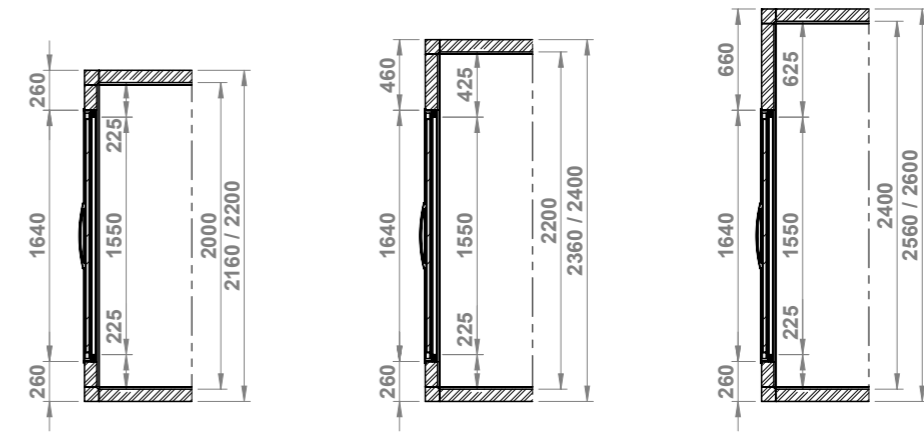
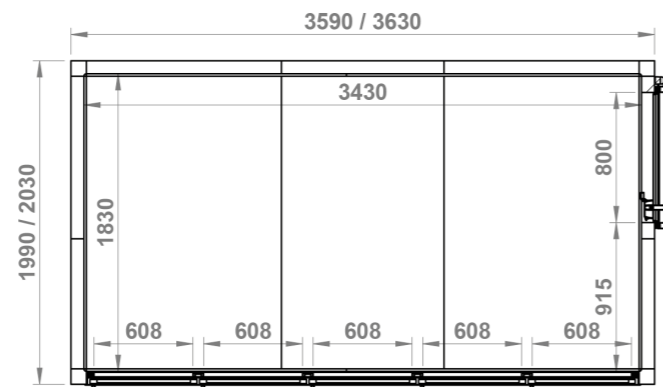
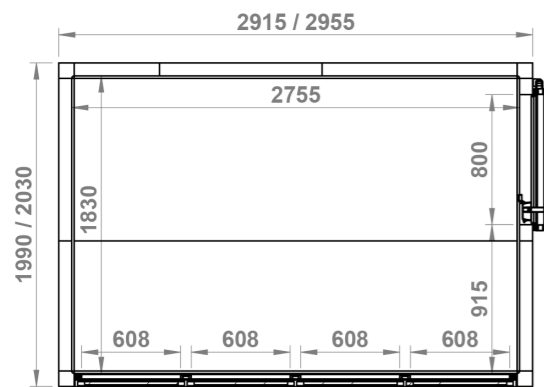
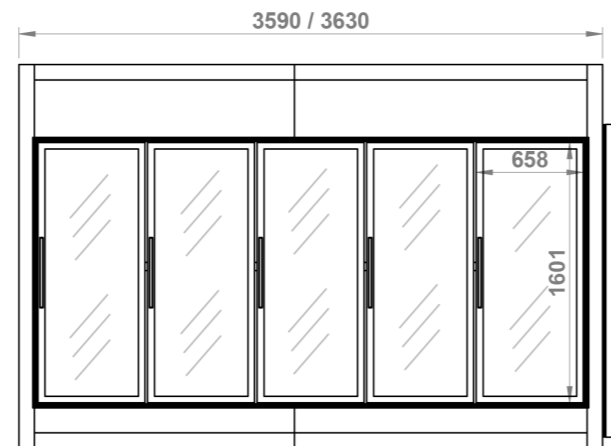
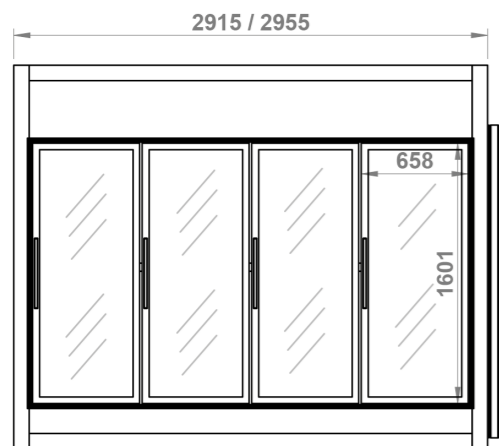
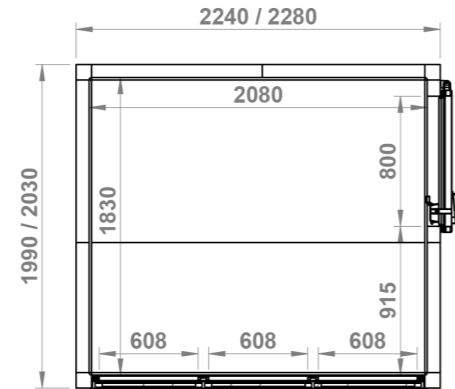
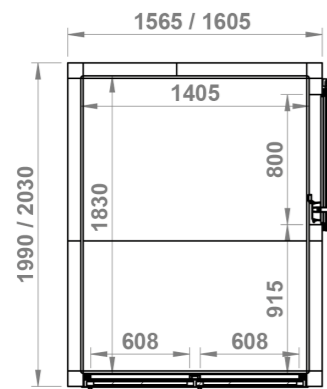
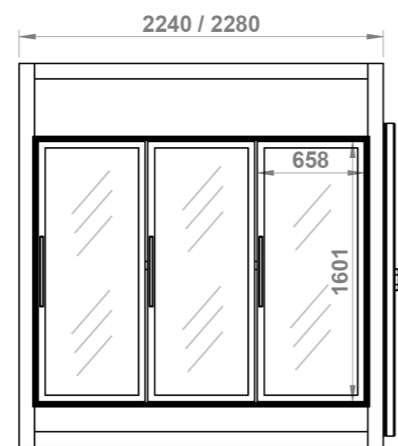
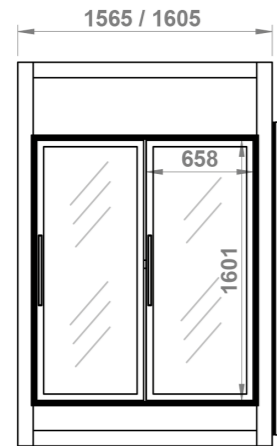
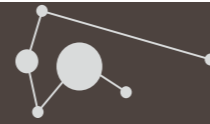

Estanterías **NO** incluidas
Shelves **NOT** included

	espesor Thickness mm	largo Length mm	alto height mm	fondo depth mm	capacidad capacity m ³	puertas doors	11/2 puertas half doors	€	
refrigeración - chiller	RFM2R-PC-A	80	1565	2160	1990	5,14	2	1	6.159 €
	RFM2R-PC-B	80	1565	2360	1990	5,62	2	1	6.400 €
	RFM2R-PC-C	80	1565	2560	1990	6,18	2	1	6.634 €
	RFM3R-PC-A	80	2240	2160	1990	7,61	3	1	7.679 €
	RFM3R-PC-B	80	2240	2360	1990	8,32	3	1	7.907 €
	RFM3R-PC-C	80	2240	2560	1990	9,15	3	1	8.134 €
	RFM4R-PC-A	80	2915	2160	1990	10,08	4	1	9.015 €
	RFM4R-PC-B	80	2915	2360	1990	11,02	4	1	9.279 €
	RFM4R-PC-C	80	2915	2560	1990	12,12	4	1	9.532 €
	RFM5R-PC-A	80	3590	2160	1990	15,55	5	1	10.057 €
RFM5R-PC-B	80	3590	2360	1990	13,72	5	1	10.348 €	
RFM5R-PC-C	80	3590	2560	1990	15,09	5	1	10.638 €	
congelados - freezer	RFM2C-PC-A	100	1605	2200	2030	5,14	2	1	6.897 €
	RFM2C-PC-B	100	1605	2400	2030	5,62	2	1	7.149 €
	RFM2C-PC-C	100	1605	2600	2030	6,18	2	1	7.402 €
	RFM3C-PC-A	100	2280	2200	2030	7,61	3	1	8.627 €
	RFM3C-PC-B	100	2280	2400	2030	8,32	3	1	8.866 €
	RFM3C-PC-C	100	2280	2600	2030	9,15	3	1	9.108 €
	RFM4C-PC-A	100	2295	2200	2030	10,08	4	1	10.647 €
	RFM4C-PC-B	100	2295	2400	2030	11,02	4	1	10.919 €
	RFM4C-PC-C	100	2295	2600	2030	12,12	4	1	11.196 €
	RFM5C-PC-A	100	3630	2200	2030	15,55	5	1	12.163 €
RFM5C-PC-B	100	3630	2400	2030	13,72	5	1	12.473 €	
RFM5C-PC-C	100	3630	2600	2030	15,09	5	1	12.782 €	

OPCIONES bajo pedido

- Otras calidades y colores para el revestimiento del panel tanto para el exterior como en el interior
- Suelo con acabado interior en acero inoxidable antideslizante
- Suelo con acabado blanco pirineo, igual al resto de paneles
- Equipo frigorífico
- Estanterías de aluminio y polietileno de fabricación propia.
- Resistencia eléctrica en cámaras de espesor 80 mm.
- Hacha de bombero
- Soporte hacha
- Alarma hombre atrapado
- Rampa para puerta abatible o corredera
- Rastreles para separación entre el panel inferior y el suelo

OPTIONS on request

- Other qualities and colors for the panel covering both for the exterior and interior
- Floor with non-slip stainless steel interior finish
- Floor with a white pyrenean finish, the same as the other panels
- Refrigeration equipment
- Self-made aluminum and polyethylene shelves.
- Electrical resistance in chambers of thickness 80 mm.
- Fire ax
- Ax support
- Trapped man alarm
- Ramp for swing or sliding door
- Tracks for separation between bottom panel and base floor

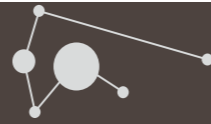

Información completa en la sección 7 de este catálogo

All data about shelving, in the section of this catalogue

ESTANTERÍAS MODULARES realizadas con una estructura de aluminio anodizado y parrillas de polietileno, aptas para el uso con productos alimentarios.

Con nuestras Estanterías y sus múltiples combinaciones conseguirá una óptima eficiencia en la organización y almacenaje. Los materiales empleados en su construcción, la hacen especialmente adecuadas para su uso en cámaras frigoríficas.

MODULAR SHELVING UNITS made with an anodized aluminium structure and polyethylene wire shelves, suitable for food storage. Our Shelving Units and their multiple combinations will enable you to efficiently store and organise your products. The materials used to build the units make them especially durable for use in cold room.

Características técnicas:

- Especialmente diseñadas para uso alimentario.
- Estructura de aluminio anodizado que proporciona gran rigidez al conjunto.
- Parrillas fabricadas en polietileno calidad alimentaria.
- Tornillería utilizada en su construcción de acero inoxidable.
- Máxima modularidad que la hace adaptable a todos los espacios.
- Dos Fondos de estantes, 400 ó 500 mm.
- Tres alturas, con estantes regulables cada 150 mm.
- También recomendadas para el uso en cámaras frigoríficas, tanto para temperaturas positivas como negativas.
- No se necesita ningún tipo de herramientas para su montaje.

Technical specifications:

- Specifically designed for use with food products.
- Strong anodized aluminium structure.
- Wire shelves are made of food grade polyethylene.
- Assembled using stainless steel screws.
- Maximum modularity making the units adaptable to all spaces.
- Two shelf depths, 400 or 500mm.
- Three heights, with adjustable shelves every 150mm.
- Also recommended for use in cold rooms, for both plus and minus temperatures.
- No tools are needed for assembly.

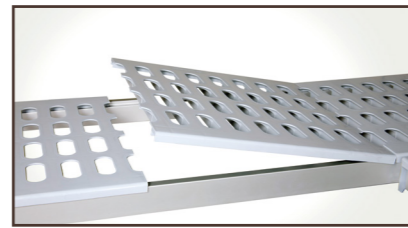
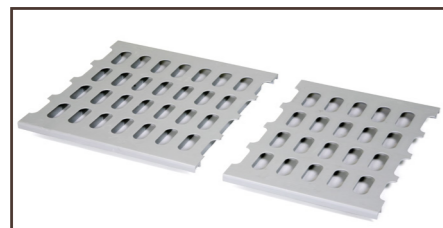

Parrillas: Fácil montaje y desmontaje. Máxima higiene. Las parrillas se pueden lavar en lavavajillas convencional.

Wire shelves: Easy assembly and disassembly. Maximum hygiene. Wire shelves can be washed in a conventional dishwasher.



Soportes ángulo: Posibilitan el montaje en ángulo de la estantería otorgándole gran modularidad.
Angle brackets: Make it possible to mount shelving units at an angle providing a high amount of flexibility.



Montaje: Fácil montaje. Todas las piezas encajan a la perfección sin necesidad de herramientas.
Assembly: Easy assembly. All pieces fit together perfectly without the need for tools.

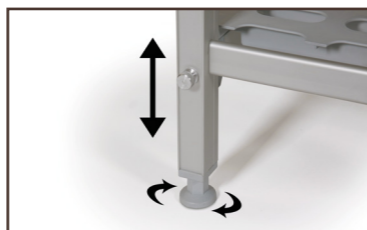

Pies: Con regulación en altura para salvar posibles desniveles del suelo.
Feet: Adjustable feet for uneven floors.

De serie:

- 1 estante base fijo de carga fijo.
- 4 estantes de carga móviles 600x665 regulables en altura (paso 80mm), inclinación (0°, 8° y 16°) y profundidad.
- Barandilla frontal de alambre plastificado blanco.
- Portaprecios.

Opción:

- Separador lateral blanco o cromado
- Barandilla frontal cromada o metacrilato

Standar:

- 1 loading level fixed
- 4 moving shelves of loading 600x665 adjustable on height (space 80mm), inclination (0°, 8° y 16°) and depth.
- Front railing in white coating wire
- Price tag

Optional:

- White or Chromed Side separator
- Chromed or Methacrylate front railing

módulo estantería shelves module	mod.	fondo depth mm	puertas doors uds	€
	ME1P600	600	1	1.110 €
	ME2P600	600	2	2.119 €
	ME3P600	600	3	3.108 €
	ME4P600	600	4	4.189 €
	ME5P600	600	5	5.233 €

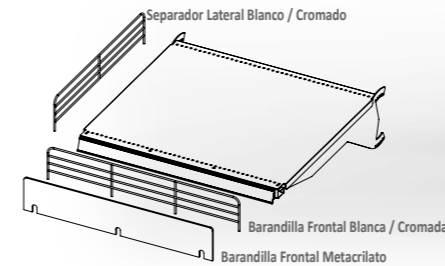

- Separación lateral, cada 1 cm.
- Lateral separation, every 1 cm.

Opcinal	Optional	€
separador lateral cromado	chromed lateral divider	35 €
barandilla frontal metacrilato	plexy front railing	35 €
barandilla frontal cromada	chromed front railing	35 €



ME2P600

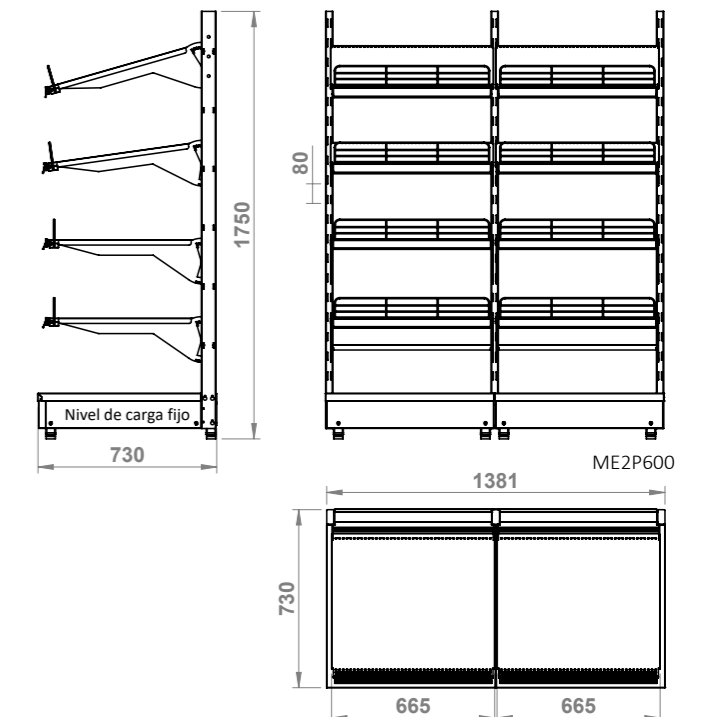

Serie AFD

3

ARMARIO FRIGORÍFICO DESMONTABLE
MODULAR REACH-IN REFRIGERATOR



CORECO



De serie:

- Estantes de 600 x 400 mm.
- 2 estantes por nivel.
- 4 niveles de estantes por cuerpo.
- Separación mínima entre estantes 70 mm.
- Puertas apertura a izquierda.
- 1/2 Puertas apertura a derechas.
- Resistencia antiescarcha y válvula en mantenimiento de congelados.
- Iluminación interior.

Opción:

- Elección de las aperturas de puertas y 1/2 puertas.
- Estantes intermedios
- Tirador con cerradura

Standard:

- Shelves 600 x 400mm.
- 2 shelves per level.
- 4 shelves per section.
- Spacing between shelves 70mm minimum.
- Left door opening.
- 1/2 right door opening.
- No-frost resistance and valve in frozen reach-in units.
- Interior lighting

Optional:

- Choice of door and 1/2 door openings.
- Intermediate shelves
- Locks with key

Armarios frigoríficos desmontables versátiles como nuestras cámaras, por lo que bajo presupuesto permiten otras opciones de construcción:

- Colocación de puertas tanto en el frontal como en la parte trasera.
- Sustitución de un panel de puertas por uno de pared vertical.
- Sin dotación interior (guías, parrillas y cremalleras)
- Construcción en diferentes alturas.
- Construcción en panel de espesor 80 o 100 mm.
- Puerta de cristal 1-1 o 1-2 en armarios de refrigeración

Modular reach-in refrigerators are as versatile as our rooms and offer low budget construction options:

- Positioning of doors on both the front and back.
- Replacing a door panel with a vertical wall panel.
- Without interior equipment (rails, wire shelves and supports).
- Different heights construction
- 80 or 100 mm thickness panel construction.
- Glass door 1-1 or 1-2 for chillers.

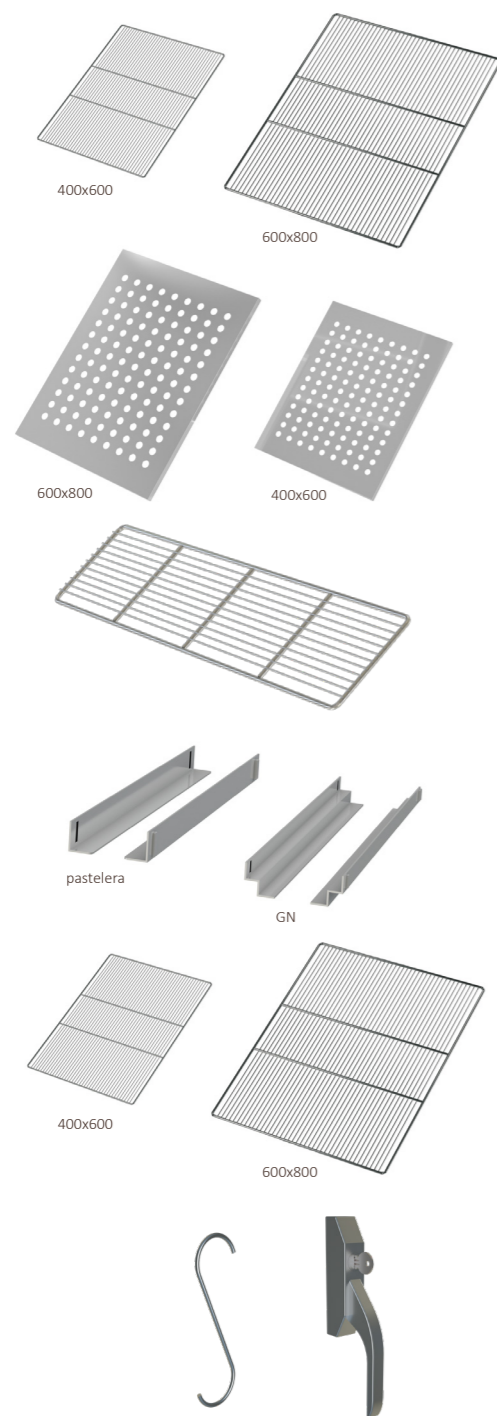

ESTANTES / SHELVES

ARTÍCULO ITEM	DIMENSIONES MEASUREMENTS	ACABADO FINISH	€
PP6080	600 x 800	Ac. plastificado Plastic-coated	57 €
PP6040	600 x 400	Ac. plastificado Plastic-coated	30 €

**ESTANTES REFORZADOS EN ACERO INOX
REINFORCED STAINLESS STEEL SHELVES**

ARTÍCULO ITEM	DIMENSIONES MEASUREMENTS	ACABADO FINISH	€
PR6080	600 x 800	Ac. inoxidable Stainless steel	120 €
PR6040	600 x 400	Ac. inoxidable Stainless steel	82 €

**ESTANTES INTERMEDIOS
INTERMEDIATE SHELVES**

ARTÍCULO ITEM	DIMENSIONES MEASUREMENTS	ACABADO FINISH	€
P17619-AFD	763 x 190	Ac. plastificado Plastic-coated stainless steel	21 €

JUEGO DE GUÍAS / SET OF RAILS

ARTÍCULO ITEM	DIMENSIONES MEASUREMENTS	ACABADO FINISH	€
L	Fondo 800	Ac. inoxidable Stainless steel	46 €
Z	Fondo 800	Ac. inoxidable Stainless steel	58 €

GASTRONORM

ARTÍCULO ITEM	DIMENSIONES MEASUREMENTS	ACABADOS FINISH	€
GN 2/1	530x650	Ac. plastificado	57 €
GN 1/1	530x325	Ac. plastificado	29 €
GN 2/1	530x650	Ac. inoxidable	98 €
GN 1/1	530x325	Ac. inoxidable	62 €

BARRAS CARNICERAS / MEAT RAILS

ARTÍCULO ITEM	PARA MODELO FOR MODEL	LONGITUD LENGTH	€
BC1	1 CUERPO / DOOR	610	185 €
GC	GANCHO CARNICERO / MEAT HOOKS		19 € x ud
TC	TIRADOR CON CERRADURA / LOCKS WITH KEY		46 € x ud

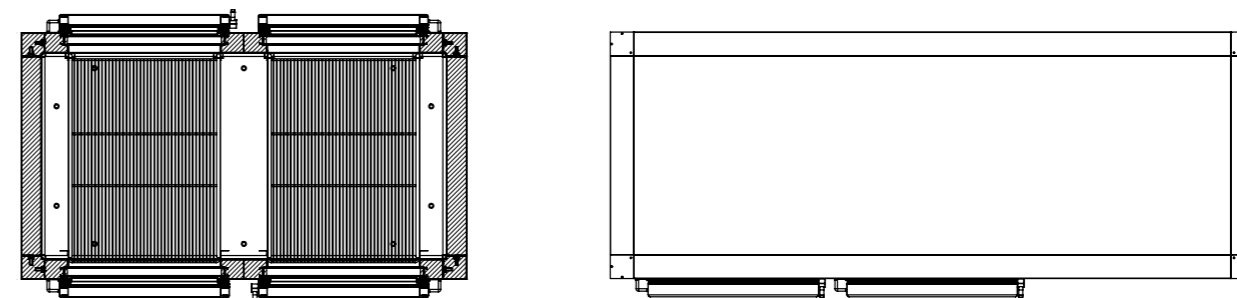

**CAMBIO DE PUERTA CIEGA A PUERTA CRISTAL REFRIGERACIÓN
SOLID DOOR TO GLASS DOOR REFRIGERATION**

ARTÍCULO ITEM	DIMENSIONES MEASUREMENTS	€
P1-1AFDVR	LUZ 610 x 1700	402 €
P1-2AFDVR	LUZ 610 x 800	242 €

Las puertas de cristal se suministrarán con iluminación led
Glass doors supplied with LED lighting



CONFIGURACIÓN DE PUERTAS DOOR COMPOSITION

1 CUERPO
1 SECTION

2 CUERPOS
2 SECTIONS

3 CUERPOS
3 SECTIONS

4 CUERPOS
4 SECTIONS

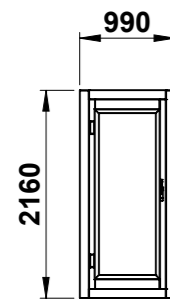

AFD-1R-A
AFD-1C-A

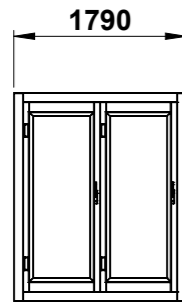

AFD-2R-A
AFD-2C-A

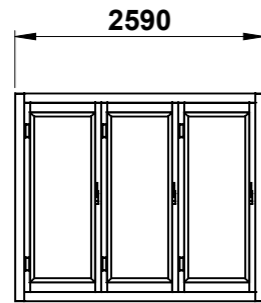

AFD-3R-A
AFD-3C-A

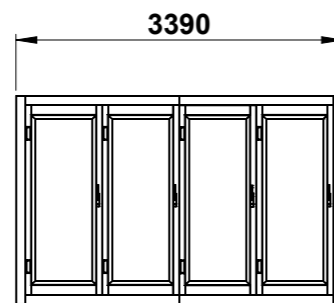

AFD-4R-A
AFD-4C-A

A

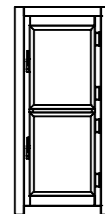

AFD-1R-B
AFD-1C-B

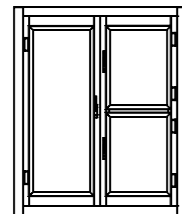

AFD-2R-B
AFD-2C-B

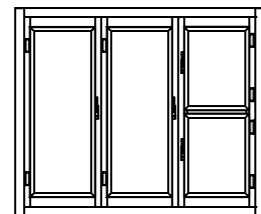

AFD-3R-B
AFD-3C-B

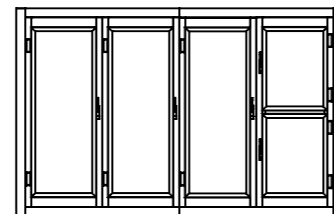

AFD-4R-B
AFD-4C-B

B

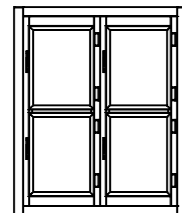

AFD-2R-C
AFD-2C-C

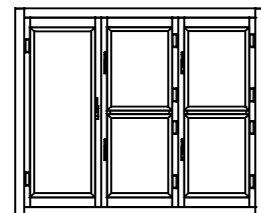

AFD-3R-C
AFD-3C-C

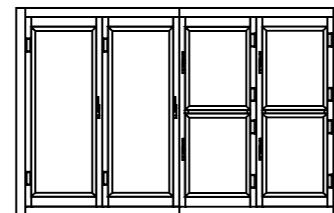

AFD-4R-C
AFD-4C-C

C

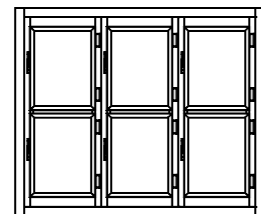

AFD-3R-D
AFD-3C-D

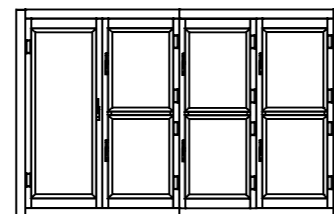

AFD-4R-D
AFD-4C-D

D

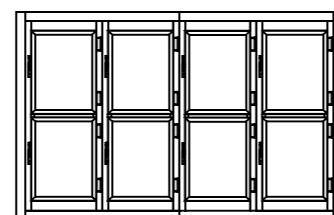
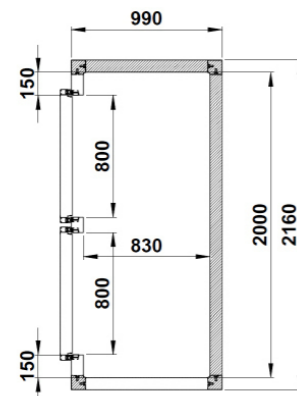
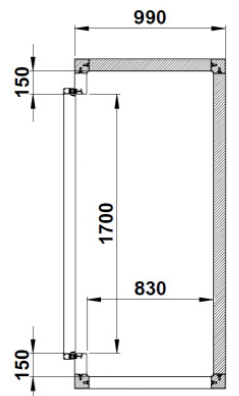

AFD-4R-E
AFD-4C-E

E

	largo length mm	alto height mm	fondo depth mm	capacidad capacity m³	puertas doors	1/2 puertas half doors	€	
refrigeración - chiller	AFD-1R-A	990	2160	990	1.38	1	-	2.232 €
	AFD-1R-B	990	2160	990	1.38	-	2	2.575 €
	AFD-2R-A	1790	2160	990	2.71	2	-	3.602 €
	AFD-2R-B	1790	2160	990	2.71	1	2	3.946 €
	AFD-2R-C	1790	2160	990	2.71	-	4	4.290 €
	AFD-3R-A	2590	2160	990	4.03	3	-	4.891 €
	AFD-3R-B	2590	2160	990	4.03	2	2	5.227 €
	AFD-3R-C	2590	2160	990	4.03	1	4	5.574 €
	AFD-3R-D	2590	2160	990	4.03	-	6	5.916 €
	AFD-4R-A	3390	2160	990	5.36	4	-	6.172 €
	AFD-4R-B	3390	2160	990	5.36	3	2	6.516 €
	AFD-4R-C	3390	2160	990	5.36	2	4	6.861 €
congelados - freezer	AFD-4R-D	3390	2160	990	5.36	1	6	7.197 €
	AFD-4R-E	3390	2160	990	5.36	-	8	7.543 €
	AFD-1C-A	990	2160	990	1.38	1	-	2.665 €
	AFD-1C-B	990	2160	990	1.38	-	2	2.830 €
	AFD-2C-A	1790	2160	990	2.71	2	-	4.303 €
	AFD-2C-B	1790	2160	990	2.71	1	2	4.462 €
	AFD-2C-C	1790	2160	990	2.71	-	4	4.628 €
	AFD-3C-A	2590	2160	990	4.03	3	-	5.764 €
	AFD-3C-B	2590	2160	990	4.03	2	2	5.930 €
	AFD-3C-C	2590	2160	990	4.03	1	4	6.096 €
	AFD-3C-D	2590	2160	990	4.03	-	6	6.255 €
	AFD-4C-A	3390	2160	990	5.36	4	-	7.236 €
AFD-4C-B	3390	2160	990	5.36	3	2	7.395 €	
AFD-4C-C	3390	2160	990	5.36	2	4	7.562 €	
AFD-4C-D	3390	2160	990	5.36	1	6	7.727 €	
AFD-4C-E	3390	2160	990	5.36	-	8	7.887 €	

Serie AFD-PC

4

ARMARIOS AFD PUERTAS DE CRISTAL ENCASTRADAS
AFD REACH-IN WITH BUILT-IN GLASS DOORS



CORECO





Armarios Frigoríficos Desmontables, GAMA AFD-PC., Ideales para la exposición de bebidas y alimentación.
 Recomendable para condiciones ambientales entre +10 y 33° C con un 65% de humedad relativa.

*AFD-PC Range of Modular Reach-In Refrigerator, are perfect to exhibit drinks and foods
 Ready to work under ambient conditions between +10 and 33° C with a 65% relative humidity.*



Estanterías NO incluidas en el precio del armario
Shelves NOT included in the reach-in standard price

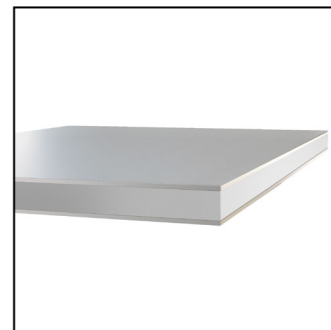

GENERALES

- Espuma rígida de poliuretano con formulación libre de CFC e inyectado a alta presión
- Densidad 45 Kg. / m²
- Coeficiente de conductividad térmica 0.022W/mK a 10°C. (Sin envejecimiento)
- Espesor de 80 mm.
- Revestimiento estándar de chapa de acero galvanizado prelacado poliéster, con film de protección pelable.
- Color blanco pirineo.
- Calidad alimentaria.
- Mecanismo de ganchos excéntricos de alta resistencia y doble efecto (gira y recoge), colocados en carcasas de ABS. El conjunto está pensado para trabajar de dos maneras: engancha y puede ser enganchado.
- Columnas perimetrales que incluyen un innovador perfil sanitario con labio flexible que se adapta al panel consiguiendo una unión perfecta de gran calidad y revestidas en su exterior con la misma chapa utilizada en los paneles, consiguiendo así una línea estética regular en toda la cámara.
- Todo el conjunto está inyectado en su interior con poliuretano de las mismas características y densidad que el resto de paneles.
- LED

MARCO ENCASTRADO

- Marco perimetral exterior de aluminio y PVC anodizado anticorrosión color plata
- Resistencia en el perímetro.

PUERTA

- Marco perimetral exterior de aluminio anodizado anticorrosión color plata.
- Burlete magnético de estanqueidad.
- Hueco de luz 1700 x 610mm en puerta
- Doble cristal en temperatura positiva: exterior 4mm templado, separador 20mm, interior 4mm bajo emisivo, Ug 1,1 W/(m².K)
- Triple cristal en temperatura negativa: exterior 4mm templado bajo emisivo, separador 8mm, central 4mm, separador 8mm, interior 4mm bajo emisivo, Ug 0,9 W/(m².K)
- Apertura a derechas (apertura a izquierda bajo pedido)
- Cristales calefactados en temperatura negativa
- Soporte de puertas en acero inoxidable.
- Tirador superpuesto.
- Muelle de retorno automático, con fuerza de retorno ajustable.

GENERAL

- Rigid polyurethane foam, CFC-free, injected at high pressure.
- Density 45kg/m².
- Thermal conductivity coefficient 0.022W/mK at 10°C. (Without ageing).
- 80 mm isolation thickness
- Galvanized steel cladding pre-lacquered with polyester, with peelable protective film, as standard.
- Colour white, "blanco pirineo".
- Food grade.
- High resistance and double effect eccentric hooks mechanism (turns and locks), installed in ABS housings. The combination is designed to work in two ways: it engages and can be hooked.
- Perimeter columns with innovative flexible sanitary lip seal that adapts to fit the panel, combining high quality and an exterior coating made with the same metal sheeting as used to make the panels, thus achieving a uniform appearance throughout the room.
- Everything is injected with polyurethane and has the same characteristics and density as the rest of the panels.
- LED

BUILT-IN FRAME

- Perimetral exterior frame, made of aluminium and anodized anti-corrosion PVC, silver colour
- Frame heating resistance

DOOR

- Perimetral exterior frame, made of aluminium and anodized anti-corrosion, silver colour
- Magnetic sealing gasket.
- Light shaft of 1700 x 610 mm in door.
- Double glazed positive temperatures: exterior tempered glass 4mm, gas 20mm, interior low-e glass 4mm, Ug 1,1 W/(m².K)
- Triple glazed negative temperatures: exterior low-e tempered glass 4mm, gas 8mm, central clear glass 4mm, gas 8mm, interior low-e glass 4mm, Ug 0,9 W/(m².K)
- Right opening (optional: left opening)
- Heated glass negative temperature
- Stainless steel door support.
- Superimposed handle.
- Adjustable automatic return spring



Estanterías NO incluidas
Shelves NOT included

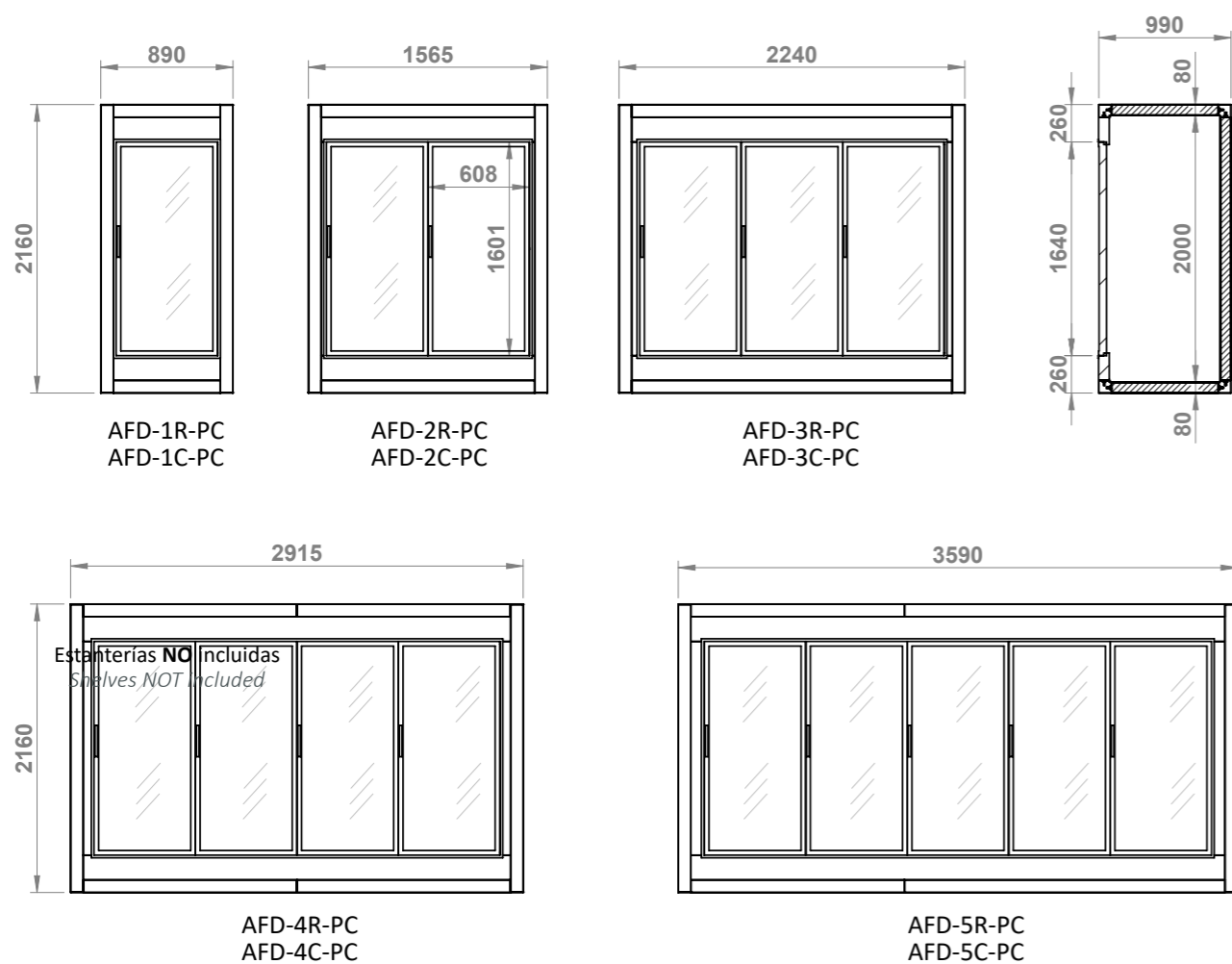

De serie:

- 1 estante base fijo de carga fijo.
- 4 estantes de carga móviles 600x665 regulables en altura (paso 80mm),
- inclinación (0°, 8° y 16°) y profundidad.
- Barandilla frontal de alambre plastificado blanco.
- Portaprecios.

Standar:

- 1 loading level fixed
- 4 moving shelves of loading 600x665 adjustable on height (space 80mm), inclination (0°, 8° y 16°) and depth.
- Front railing in white coating wire
- Price tag

Opción:

- Separador lateral blanco o cromado
- Barandilla frontal cromada o metacrilato

Optional:

- White or Chromed Side separator
- Chromed or Methacrylate front railing

módulo estantería shelves module	mod.	fondo depth mm	puertas doors uds	€
	ME1P600	600	1	1.110 €
	ME2P600	600	2	2.119 €
	ME3P600	600	3	3.108 €
	ME4P600	600	4	4.189 €
	ME5P600	600	5	5.233 €

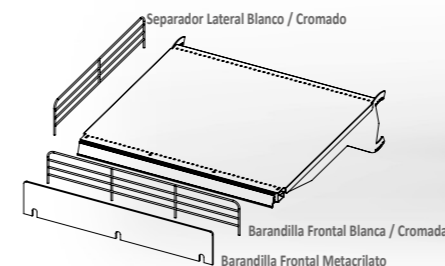

- Separación lateral, cada 1 cm.
- Lateral separation, every 1 cm.

Opcinal	Optional	€
separador lateral cromado	chromed lateral divider	35 €
barandilla frontal metacrilato	plexy front railing	35 €
barandilla frontal cromada	chromed front railing	35 €

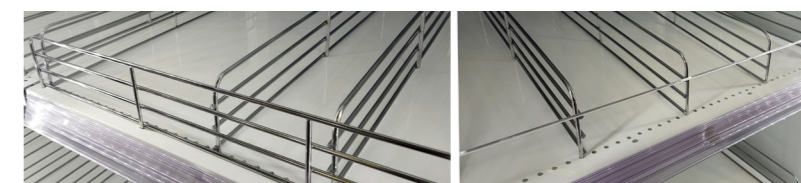

	largo Length mm	alto height mm	fondo depth mm	capacidad capacity m³	puertas doors	1/2 puertas half doors	€	
refrigeración - chiller	AFD-1R-PC	890	2160	990	1,21	1	0	3.480 €
	AFD-2R-PC	1565	2160	990	2,33	2	0	4.751 €
	AFD-3R-PC	2240	2160	990	3,48	3	0	6.018 €
	AFD-4R-PC	2915	2160	990	4,57	4	0	7.217 €
	AFD-5R-PC	3590	2160	990	5,69	5	0	8.097 €
congelados - freezer	AFD-1C-PC	890	2160	990	1,21	1	0	3.838 €
	AFD-2C-PC	1565	2160	990	2,33	2	0	5.285 €
	AFD-3C-PC	2240	2160	990	3,48	3	0	6.720 €
	AFD-4C-PC	2915	2160	990	4,57	4	0	8.441 €
	AFD-5C-PC	3590	2160	990	5,69	5	0	9.782 €

Opción:

Alturas diferentes a la estándar: 2360 y 2560
Espesor : 100mm

Optional:

Alternative heights: 2360 and 2560
Thickness: 100 mm

Estanterías NO incluidas
Shelves NOT included

Características técnicas y constructivas sujetas a variación sin previo aviso.

We reserve the right to change specifications without prior notice.

Características técnicas y constructivas sujetas a variación sin previo aviso.

We reserve the right to change specifications without prior notice.

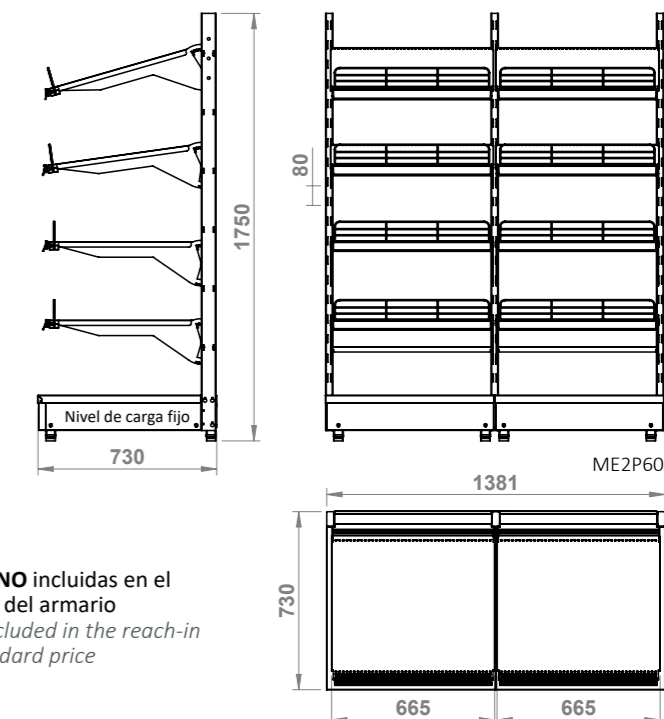

Estanterías NO incluidas en el
precio del armario
Shelves NOT included in the reach-in
standard price

S-line

Serie RFM-S

5

RECINTOS FRIGORÍFICOS MODULARES
SIN COLUMNAS

*MODULAR COLD ROOMS
WITHOUT COLUMNS*



CORECO



Recintos Frigoríficos Modulares, GAMA RFM-S, completa la primera gama presentada meses atrás por CORECO. Hemos desarrollado esta gama, reduciendo los elementos constructivos manteniendo la solidez y capacidad aislante del recinto. Esta nueva gama, se manufactura siguiendo los mismos principios empleados en el resto de la producción de cámaras frigoríficas, con maquinaria controlada por computadora y personal cualificado. El resultado es un recinto frigorífico con personalidad propia y adaptado a las exigencias del mercado actual.

RFM-S RANGE cold rooms, completes the first range presented months ago by CORECO. We have developed this range, reducing the construction elements while maintaining the solidity and insulating capacity of the room. This new range is manufactured following the same principles used in the rest of the production of cold rooms, with computer-controlled machinery and qualified personnel. The result is a Refrigerating Enclosure with its own personality and adapted to the demands of the current market.



Sistema de montaje SIN COLUMNAS

Panel to panel, easy assembly system

S-line

Características técnicas y constructivas sujetas a variación sin previo aviso.

We reserve the right to change specifications without prior notice.

SECCIÓN Y ALTURAS. / HEIGHTS AND SECTIONS.

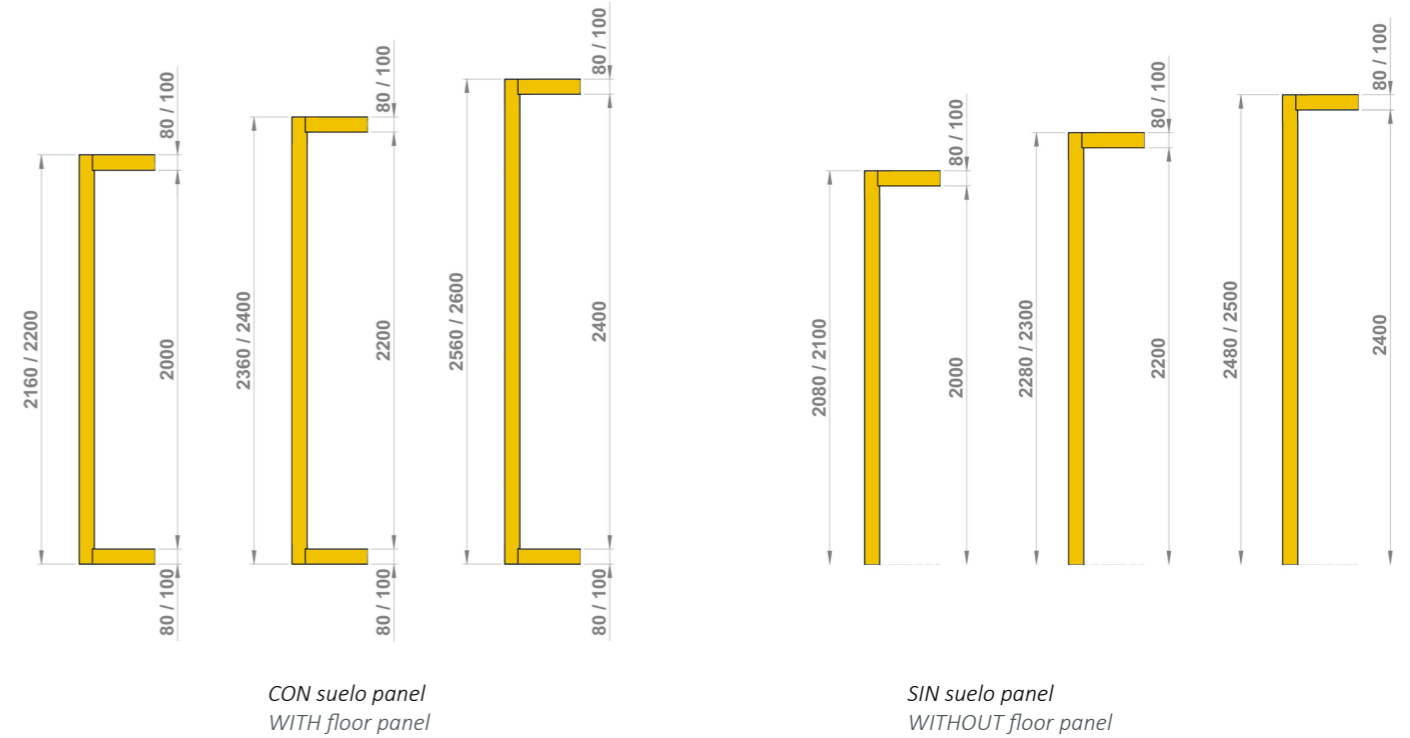

ESPACIOS NECESARIOS PARA UNA CORRECTA INSTALACIÓN.

Recomendamos una adecuada nivelación del suelo donde vaya a ser instalado el recinto frigorífico. Prever que el lugar de ubicación permite el acceso del panel de mayor dimensión.

SPACE NEEDED FOR CORRECT INSTALLATION.

We recommend an adequate leveling of the floor where the cold room will be installed. Ensure that the location allows access with the largest panel.

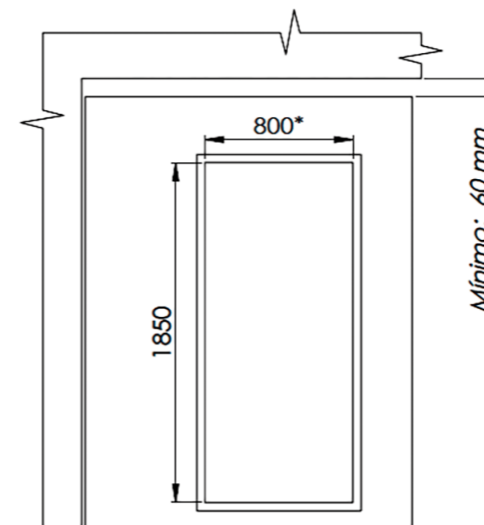

*Bajo pedido, 600, 700, 900 y 1000
*On demand 600, 700, 900 and 1000

Para poder realizar un montaje correcto es necesario dejar entre el techo del local y el techo del recinto al menos el espesor del panel + 20 mm.

For correct assembly, leave at least the thickness of a panel + 20mm between the roof of the premises and the roof of the room.

Características técnicas y constructivas sujetas a variación sin previo aviso.

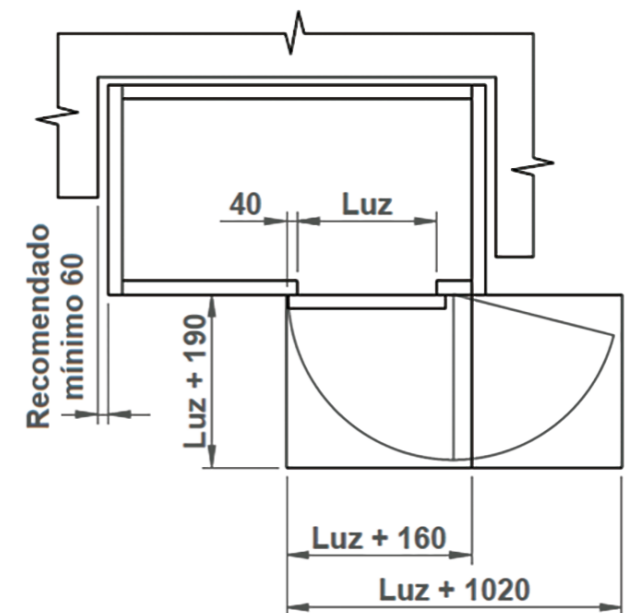

Dimensiones necesarias para una apertura de la puerta a 90° y 180°.
Measurements needed to open the door at 90° and 180°.

We reserve the right to change specifications without prior notice.

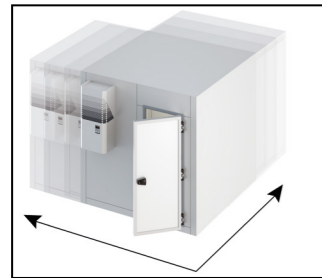

S-line

Modularidad y paneles:

- Espesor de 80 y 100 mm
- Modulación 200 mm.
- Cuatro anchos de panel: 400, 800, 1000 y 1200 mm
- Alturas exteriores panel 80: 2160, 2360 y 2560 mm
- Alturas exteriores panel 100: 2200, 2400, 2600
- Longitud máxima del panel 3120 mm (80) 3160 (100)

Modularity and panels:

- Thickness of 80 and 100 mm
- Modulation 200 mm.
- Four panel widths: 400, 800, 1000 and 1200 mm
- Exterior panel heights 80: 2160, 2360 and 2560 mm
- Exterior panel heights 100: 2200, 2400, 2600
- Maximum panel length 3120 mm (80) 3160 (100)

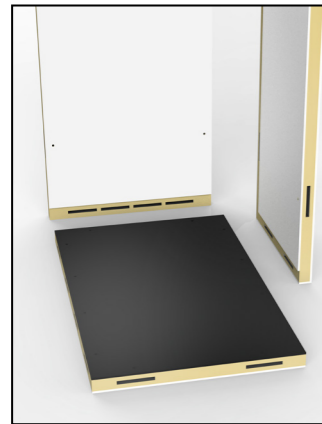
Aislamiento:

- Espuma rígida de poliuretano, libre de CFC e inyectado a alta presión
- Densidad 45 Kg. / m²
- Coeficiente de conductividad térmica 0.022W/mK a 10°C. (Sin envejecimiento)

Insulation:

- Rigid polyurethane foam, CFC-free, injected at high pressure.
- Density 45kg/m².
- Thermal conductivity coefficient 0.022W/mK at 10°C. (Without ageing).

Revestimiento:

- Revestimiento estándar en acero galvanizado prelacado poliéster, con film de protección.
- Color blanco pireneo.
- Calidad alimentaria.

Cladding:

- Galvanized steel cladding pre-lacquered with polyester, with a protective film, as standard.
- Colour white, "blanco pireneo".
- Food grade.

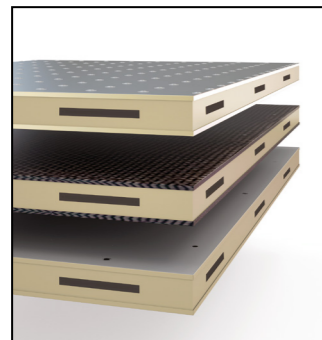
Terminación del Panel de Suelo:

- Suelo reforzado: Idóneo para el tránsito de personas y carretillas manuales. Acabado interior de contrachapado de abedul y resina fenólica antideslizante.
- Suelo de acero inoxidable antideslizante aisi 304 18/8.
- Suelo de chapa lacada blanca igual que el resto de paneles.

Floor Panel Finish:

- Reinforced flooring: Ideal for the transit of people and manual trucks. Birch plywood interior finish with non-slip phenolic resin.
- Non-slip stainless steel flooring AISI 304 18/8.
- Metal flooring lacquered white the same as the rest of the panels.

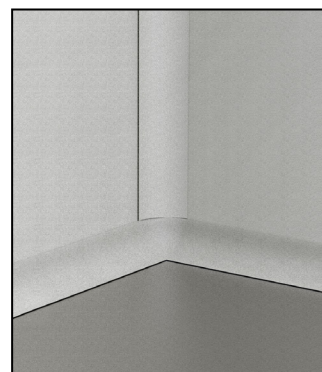
Perfil sanitario perimetral:

- Diseño cóncavo, dos piezas más tapones esquineros en las uniones
- Base de fijación fabricada en PVC alta resistencia y dispuesta en ángulo
- Perfil sanitario rígido en su parte central y flexible en los extremos para adaptarse al panel
- Esquinas rematadas con tapón de diseño semiesférico para dar continuidad al perímetro sanitario

Perimetral sanitary profile:

- Concave design, two pieces and corner plugs for the joints
- Base profile made of high resistance PVC and angled
- Rigid sanitary profile in its central part and flexible at the ends
- Finishing corners with a hemispherical design cap, let to continuity the sanitary perimetral structure

Sistema de Unión:

- Vástago giratorio, encajable en alojamiento con sistema de sujeción por presión, llave incluida, fabricado en ABS de alta resistencia.

Panel fixings:

- Swivel stem, nestable in housing with a pressure clamping system, key included, made of high resistance ABS.

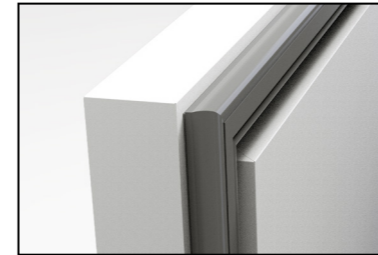
Puerta:

- Pivotante con apertura a mano derecha, puede colocarse en los 4 lados de la cámara
- Bultete desmontable con ajuste perimetral sobre el marco, asegura la estanqueidad
- Hueco de luz de puerta 1850 x 800 mm
- Sólo en panel 100 mm: resistencia eléctrica antiescarcha colocada en el marco del panel de puerta con caja de conexiones
- Panel puerta y la puerta, están aisladas con el mismo poliuretano empleado en el resto de paneles
- Bisagras de gran calidad y resistencia
- Cierre de un punto de presión, con llave exterior y desbloqueo interior

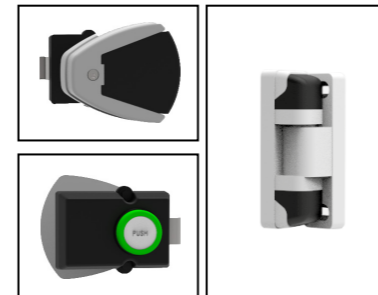
Door:

- Pivoting door with right-hand opening, can be placed on all 4 sides of the cold room
- Removable gasket with perimeter adjustment on the frame, ensures tightness
- Door passthrough 1850 x 800 mm
- Only for panel 100: electric frost resistance on the door panel frame with connections box
- Door panel and door are insulated with the same polyurethane used in the whole structure
- High quality and resistant hinges
- Locking of a pressure point, with external key and internal release

Accesorios incluidos:

- Válvula compensadora de presiones para todas las cámaras de espesor 100
- Perfil sanitario postizo
- Perfil "U" de montaje para cámaras sin panel de suelo
- Luz interior
- Llave hexagonal con mango para montaje de las fijaciones de paneles
- Caja de conexiones y resistencia marco sólo en puerta para panel 100

Parts included:

- Pressure compensation valve for all chambers of thickness 100
- Detachable sanitary profile
- Mounting "U" profile for cameras without floor panel
- Interior light
- Hexagonal wrench with handle for mounting panel fixings
- Junction box and resistance frame only in door for panel 100

OPCIONES bajo pedido

- Otras calidades y colores para el revestimiento del panel tanto para el exterior como en el interior
- Suelo con acabado interior en acero inoxidable antideslizante
- Suelo con acabado blanco pireneo, igual al resto de paneles
- Equipo frigorífico
- Estanterías de aluminio y polietileno de fabricación propia.
- Resistencia eléctrica en cámaras de espesor 80 mm.
- Puerta apertura a mano izquierda (estándar abre a mano derecha)
- Puerta corredera 1850 x 800 mm
- Huecos de puerta, abatible o corredera, con anchos especiales: 600, 700, 900 y 1000 mm
- Hacha de bombero
- Soporte hacha
- Alarma hombre atrapado
- Rampa para puerta abatible o corredera
- Rastres para separación entre el panel inferior y el suelo

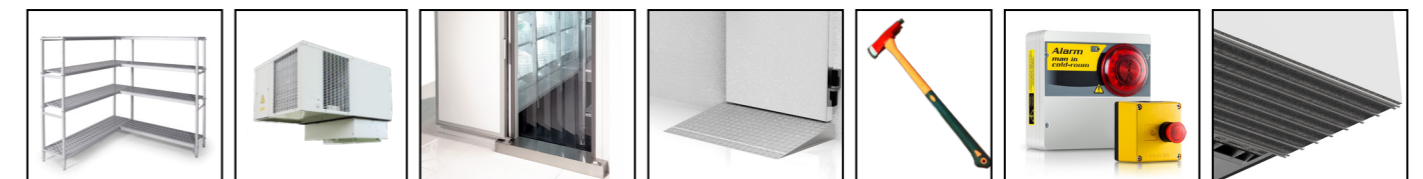
OPTIONS on request

- Other qualities and colors for the panel covering both for the exterior and interior
- Floor with non-slip stainless steel interior finish
- Floor with a white pyrenean finish, the same as the other panels
- Refrigeration equipment
- Self-made aluminum and polyethylene shelves.
- Electrical resistance in chambers of thickness 80 mm.
- Door open on the left (standard opens on the right)
- Sliding door 1850 x 800 mm
- Door openings, pivoting or sliding, with special widths: 600, 700, 900 and 1000 mm
- Fire ax
- Ax support
- Trapped man alarm
- Ramp for swing or sliding door
- Tracks for separation between bottom panel and base floor



Información completa en la sección 7 de este catálogo

All data about shelving, in the section of this catalogue

ESTANTERÍAS MODULARES realizadas con una estructura de aluminio anodizado y parrillas de polietileno, aptas para el uso con productos alimentarios.

Con nuestras Estanterías y sus múltiples combinaciones conseguirá una óptima eficiencia en la organización y almacenaje. Los materiales empleados en su construcción, la hacen especialmente adecuadas para su uso en cámaras frigoríficas.

MODULAR SHELVING UNITS made with an anodized aluminium structure and polyethylene wire shelves, suitable for food storage. Our Shelving Units and their multiple combinations will enable you to efficiently store and organise your products. The materials used to build the units make them especially durable for use in cold room.

Características técnicas:

- Especialmente diseñadas para uso alimentario.
- Estructura de aluminio anodizado que proporciona gran rigidez al conjunto.
- Parrillas fabricadas en polietileno calidad alimentaria.
- Tornillería utilizada en su construcción de acero inoxidable.
- Máxima modularidad que la hace adaptable a todos los espacios.
- Dos Fondos de estantes, 400 ó 500 mm.
- Tres alturas, con estantes regulables cada 150 mm.
- También recomendadas para el uso en cámaras frigoríficas, tanto para temperaturas positivas como negativas.
- No se necesita ningún tipo de herramientas para su montaje.

Technical specifications:

- Specifically designed for use with food products.
- Strong anodized aluminium structure.
- Wire shelves are made of food grade polyethylene.
- Assembled using stainless steel screws.
- Maximum modularity making the units adaptable to all spaces.
- Two shelf depths, 400 or 500mm.
- Three heights, with adjustable shelves every 150mm.
- Also recommended for use in cold rooms, for both plus and minus temperatures.
- No tools are needed for assembly.



ALTURA 1370 mm.
FONDO 400 Ó 500 mm.
3 ó 4 NIVELES

HEIGHT 1370mm
DEPTH 400 or 500mm
3 or 4 SHELVES

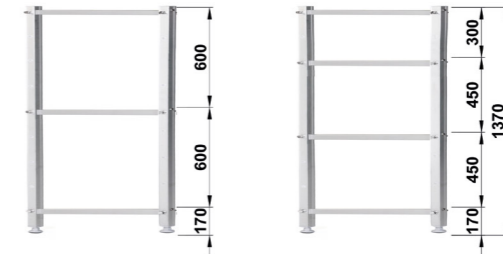

ALTURA 1670 mm.
FONDO 400 Ó 500 mm.
3 ó 4 NIVELES

HEIGHT 1670mm
DEPTH 400 or 500mm
3 or 4 SHELVES

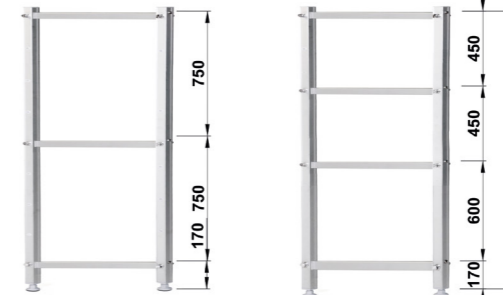

**Separación mínima
150 mm**

*150 mm
min. distance*

ALTURA 1970 mm.
FONDO 400 Ó 500 mm.
3,4 ó 5 NIVELES

HEIGHT 1970mm
DEPTH 400 or 500mm
3, 4 or 5 SHELVES

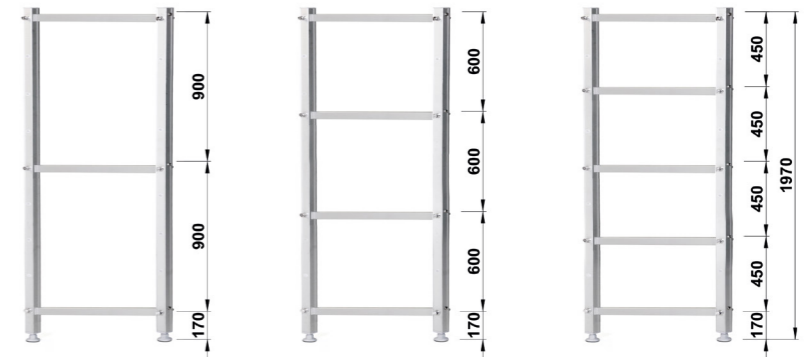

LONGITUD DE ESTANTERÍAS LINEALES INDIVIDUALES. COMPOSICIÓN DE ESTANTES.

LENGTH OF INDIVIDUAL LINEAR SHELVING UNITS. SHELF ASSEMBLY.

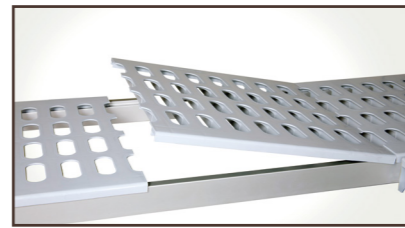
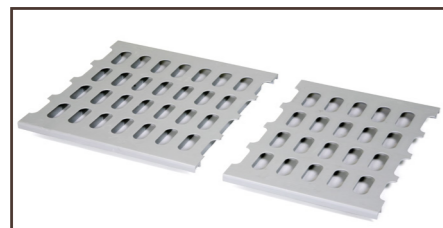
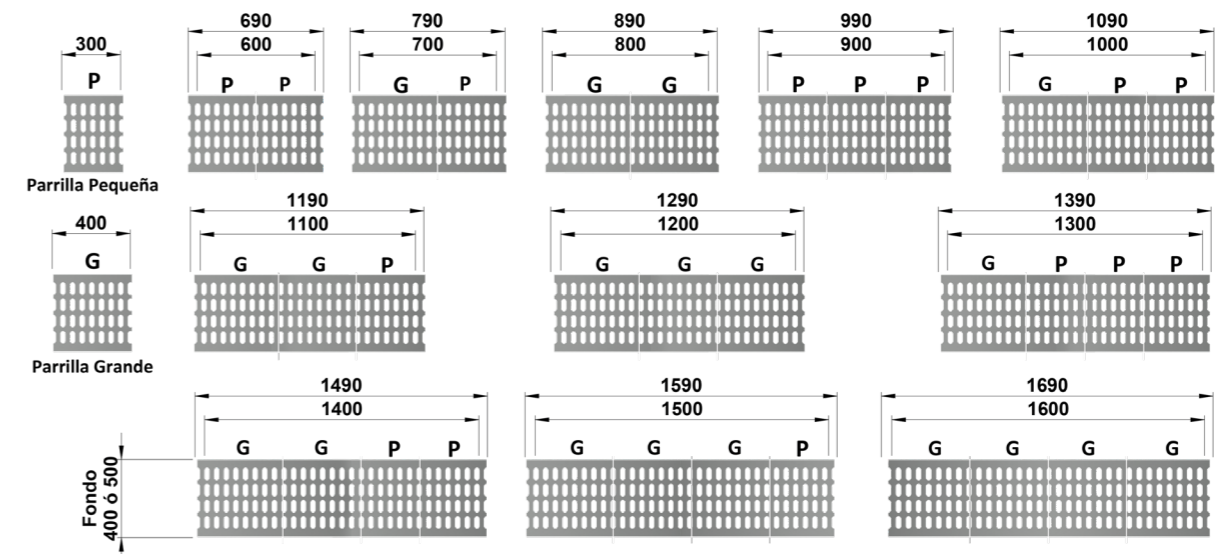

Parrillas: Fácil montaje y desmontaje. Máxima higiene. <Las parrillas se pueden lavar en lavavajillas convencional.

Wire shelves: Easy assembly and disassembly. Maximum hygiene. Wire shelves can be washed in a conventional dishwasher.



Soportos ángulo: Posibilitan el montaje en ángulo de la estantería otorgándole gran modularidad. *Angle brackets: Make it possible to mount shelving units at an angle providing a high amount of flexibility.*



Montaje: Fácil montaje. Todas las piezas encajan a la perfección sin necesidad de herramientas. *Assembly: Easy assembly. All pieces fit together perfectly without the need for tools.*

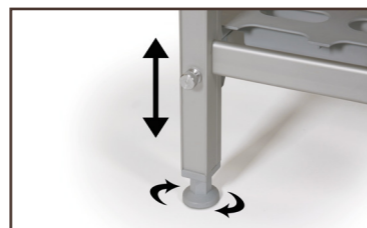

Pies: Con regulación en altura para salvar posibles desniveles del suelo. *Feet: Adjustable feet for uneven floors.*



En las tablas de la siguiente página, se identifica el modelo del recinto correspondiente con el espesor de aislamiento (80 / 100 mm) y las medias en planta (largo y fondo).

Este código le dirigirá a la página correspondiente, donde en base a la altura y tipo de suelo, podrá determinar código y precio del recinto.

También se identifica en la tabla particular para cada configuración, el volumen interior de la cámara, lo cual le ayudará a seleccionar el equipo frigorífico apropiado.

The tables on the following page show the corresponding room model with an insulation thickness of 80/100mm and its floor measurements (length and width).

Use the code to locate the corresponding page, where based on the height and type of floor, you can determine the code and price of the room.

For each room layout the table also gives its interior volume, to help you to select the appropriate refrigerator equipment.

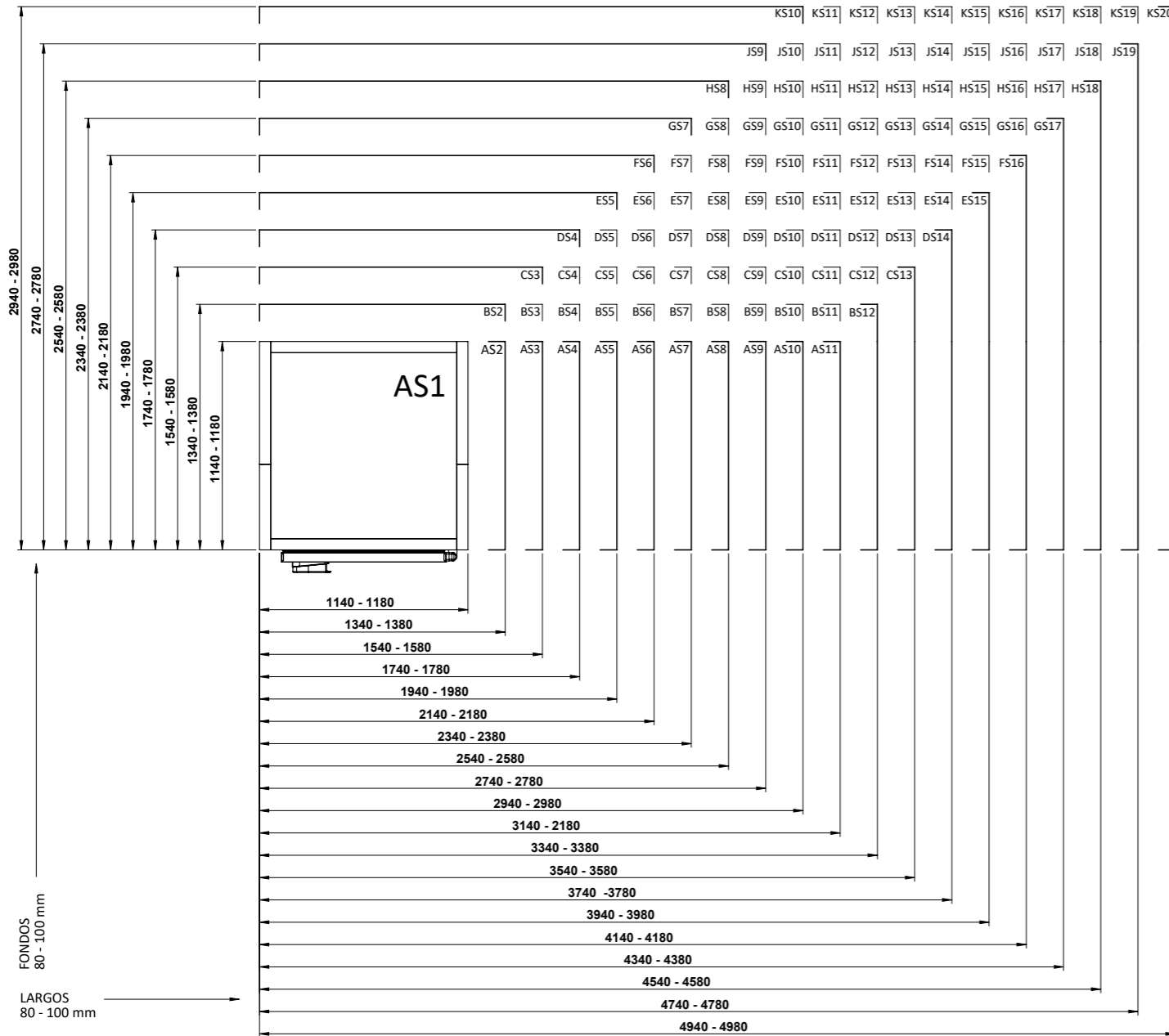

80		Largo - Length (L) mm																				
		1140	1340	1540	1740	1940	2140	2340	2540	2740	2940	3140	3340	3540	3740	3940	4140	4340	4540	4740	4940	PAG
Fondo - Depth mm	1140	AS1	AS2	AS3	AS4	AS5	AS6	AS7	AS8	AS9	AS10	AS11										
	1340		BS2	BS3	BS4	BS5	BS6	BS7	BS8	BS9	BS10	BS11	BS12									
	1540			CS3	CS4	CS5	CS6	CS7	CS8	CS9	CS10	CS11	CS12	CS13								
	1740				DS4	DS5	DS6	DS7	DS8	DS9	DS10	DS11	DS12	DS13	DS14							
	1940					ES5	ES6	ES7	ES8	ES9	ES10	ES11	ES12	ES13	ES14	ES15						
	2140						FS6	FS7	FS8	FS9	FS10	FS11	FS12	FS13	FS14	FS15	FS16					
	2340								GS7	GS8	GS9	GS10	GS11	GS12	GS13	GS14	GS15	GS16	GS17			
	2540									HS8	HS9	HS10	HS11	HS12	HS13	HS14	HS15	HS16	HS17	HS18		
	2740										JS9	JS10	JS11	JS12	JS13	JS14	JS15	JS16	JS17	JS18	JS19	
	2940											KS10	KS11	KS12	KS13	KS14	KS15	KS16	KS17	KS18	KS19	KS20

100		Largo - Length (L) mm																				
		1180	1380	1580	1780	1980	2180	2380	2580	2780	2980	3180	3380	3580	3780	3980	4180	4380	4580	4780	4980	PAG
Fondo - Depth mm	1180	AS1	AS2	AS3	AS4	AS5	AS6	AS7	AS8	AS9	AS10	AS11										
	1380		BS2	BS3	BS4	BS5	BS6	BS7	BS8	BS9	BS10	BS11	BS12									
	1580			CS3	CS4	CS5	CS6	CS7	CS8	CS9	CS10	CS11	CS12	CS13								
	1780				DS4	DS5	DS6	DS7	DS8	DS9	DS10	DS11	DS12	DS13	DS14							
	1980					ES5	ES6	ES7	ES8	ES9	ES10	ES11	ES12	ES13	ES14	ES15						
	2180						FS6	FS7	FS8	FS9	FS10	FS11	FS12	FS13	FS14	FS15	FS16					
	2380							GS7	GS8	GS9	GS10	GS11	GS12	GS13	GS14	GS15	GS16	GS17				
	2580								HS8	HS9	HS10	HS11	HS12	HS13	HS14	HS15	HS16	HS17	HS18			
	2780									JS9	JS10	JS11	JS12	JS13	JS14	JS15	JS16	JS17	JS18	JS19		
	2980										KS10	KS11	KS12	KS13	KS14	KS15	KS16	KS17	KS18	KS19	KS20	

A la hora de elegir su cámara, tenga en cuenta que la ubicación de la puerta estará siempre colocada en el largo.
At time of choosing your Cold Room, keep in mind that the location of the door will always be placed on the length part of the Cold Room.

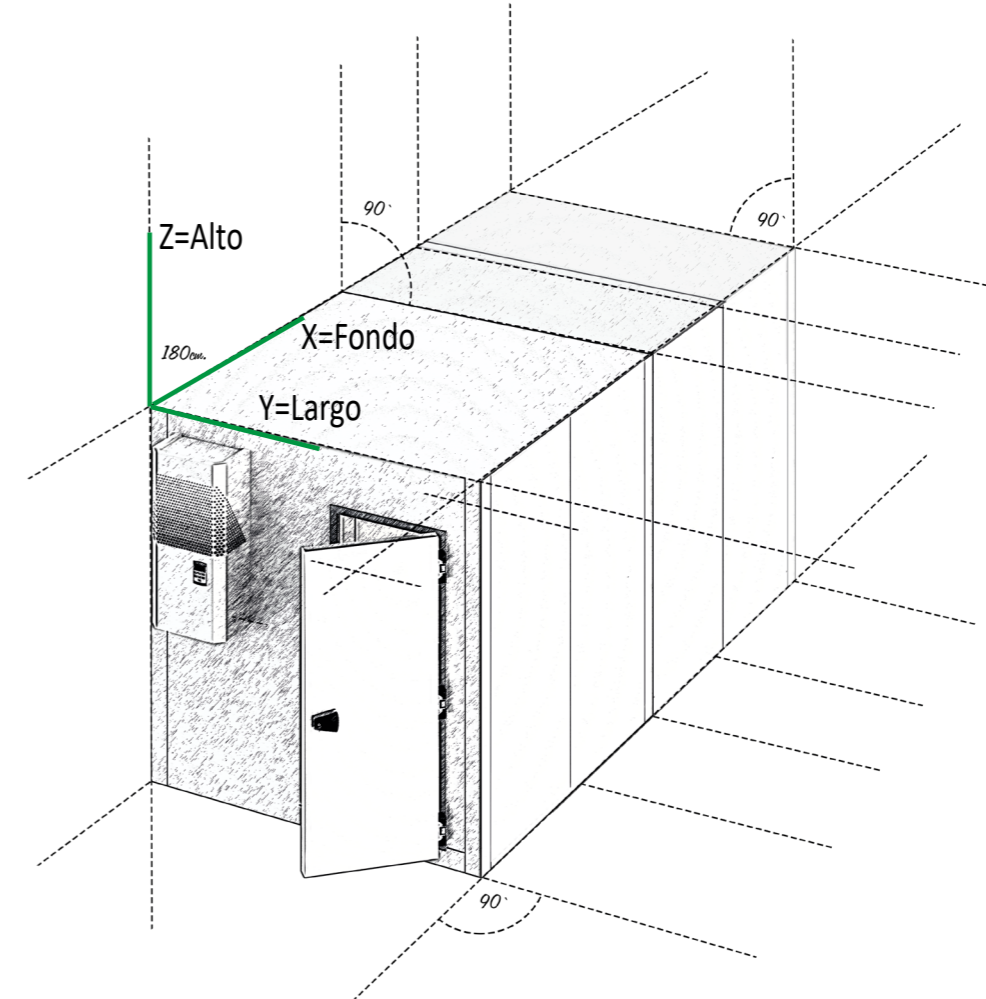



80	Largo - Length (L)																			
	1140	1340	1540	1740	1940	2140	2340	2540	2740	2940	3140	3340	3540	3740	3940	4140	4340	4540	4740	4940
Fondo - Depth mm 1140	AS1	AS2	AS3	AS4	AS5	AS6	AS7	AS8	AS9	AS10	AS11									

80	CON suelo - WITH floor panel					SIN suelo - WITHOUT floor panel				
	COD	m²	L	H	€	COD	m²	L	H	€
AS1	AS1R-114114AC	1,92	1140	2160	2.459 €	AS1R-114114AS	1,92	1140	2080	2.396 €
	AS1R-114114BC	2,11	1140	2360	2.582 €	AS1R-114114BS	2,11	1140	2280	2.519 €
	AS1R-114114CC	2,30	1140	2560	2.706 €	AS1R-114114CS	2,30	1140	2480	2.642 €
AS2	AS2R-114134AC	2,31	1340	2160	2.642 €	AS2R-114134AS	2,31	1340	2080	2.543 €
	AS2R-114134BC	2,54	1340	2360	2.771 €	AS2R-114134BS	2,54	1340	2280	2.681 €
	AS2R-114134CC	2,78	1340	2560	2.907 €	AS2R-114134CS	2,78	1340	2480	2.817 €
AS3	AS3R-114154AC	2,70	1540	2160	2.824 €	AS3R-114154AS	2,70	1540	2080	2.700 €
	AS3R-114154BC	2,98	1540	2360	2.964 €	AS3R-114154BS	2,98	1540	2280	2.842 €
	AS3R-114154CC	3,25	1540	2560	3.107 €	AS3R-114154CS	3,25	1540	2480	2.992 €
AS4	AS4R-114174AC	3,10	1740	2160	2.997 €	AS4R-114174AS	3,10	1740	2080	2.847 €
	AS4R-114174BC	3,41	1740	2360	3.153 €	AS4R-114174BS	3,41	1740	2280	3.003 €
	AS4R-114174CC	3,72	1740	2560	3.307 €	AS4R-114174CS	3,72	1740	2480	3.120 €
AS5	AS5R-114194AC	3,49	1940	2160	3.179 €	AS5R-114194AS	3,49	1940	2080	2.997 €
	AS5R-114194BC	3,84	1940	2360	3.346 €	AS5R-114194BS	3,84	1940	2280	3.174 €
	AS5R-114194CC	4,19	1940	2560	3.507 €	AS5R-114194CS	4,19	1940	2480	3.335 €
AS6	AS6R-114214AC	3,88	2140	2160	3.360 €	AS6R-114214AS	3,88	2140	2080	3.145 €
	AS6R-114214BC	4,27	2140	2360	3.533 €	AS6R-114214BS	4,27	2140	2280	3.328 €
	AS6R-114214CC	4,66	2140	2560	3.709 €	AS6R-114214CS	4,66	2140	2480	3.516 €
AS7	AS7R-114234AC	4,27	2340	2160	3.542 €	AS7R-114234AS	4,27	2340	2080	3.301 €
	AS7R-114234BC	4,70	2340	2360	3.729 €	AS7R-114234BS	4,70	2340	2280	3.495 €
	AS7R-114234CC	5,13	2340	2560	3.910 €	AS7R-114234CS	5,13	2340	2480	3.689 €
AS8	AS8R-114254AC	4,66	2540	2160	3.715 €	AS8R-114254AS	4,66	2540	2080	3.457 €
	AS8R-114254BC	5,13	2540	2360	3.915 €	AS8R-114254BS	5,13	2540	2280	3.656 €
	AS8R-114254CC	5,60	2540	2560	4.117 €	AS8R-114254CS	5,60	2540	2480	3.858 €
AS9	AS9R-114274AC	5,06	2740	2160	3.897 €	AS9R-114274AS	5,06	2740	2080	3.605 €
	AS9R-114274BC	5,56	2740	2360	4.104 €	AS9R-114274BS	5,56	2740	2280	3.819 €
	AS9R-114274CC	6,07	2740	2560	4.318 €	AS9R-114274CS	6,07	2740	2480	4.039 €
AS10	AS10R-114294AC	5,45	2940	2160	4.078 €	AS10R-114294AS	5,45	2940	2080	3.761 €
	AS10R-114294BC	5,99	2940	2360	4.299 €	AS10R-114294BS	5,99	2940	2280	3.989 €
	AS10R-114294CC	6,54	2940	2560	4.518 €	AS10R-114294CS	6,54	2940	2480	4.215 €
AS11	AS11R-114314AC	5,84	3140	2160	4.253 €	AS11R-114314AS	5,84	3140	2080	3.910 €
	AS11R-114314BC	6,42	3140	2360	4.486 €	AS11R-114314BS	6,42	3140	2280	4.143 €
	AS11R-114314CC	7,01	3140	2560	4.719 €	AS11R-114314CS	7,01	3140	2480	4.383 €

100	Largo - Length (L)																			
	1180	1380	1580	1780	1980	2180	2380	2580	2780	2980	3180	3380	3580	3780	3980	4180	4380	4580	4780	4980
Fondo - Depth mm 1180	AS1	AS2	AS3	AS4	AS5	AS6	AS7	AS8	AS9	AS10	AS11									

100	CON suelo - WITH floor panel					SIN suelo - WITHOUT floor panel				
	COD	m²	L	H	€	COD	m²	L	H	€
AS1	AS1C-118118AC	1,92	1180	2200	2.712 €	AS1C-118118AS	1,92	1180	2100	2.577 €
	AS1C-118118BC	2,11	1180	2400	2.842 €	AS1C-118118BS	2,11	1180	2300	2.706 €
	AS1C-118118CC	2,30	1180	2600	2.972 €	AS1C-118118CS	2,30	1180	2500	2.834 €
AS2	AS2C-118138AC	2,31	1380	2200	2.907 €	AS2C-118138AS	2,31	1380	2100	2.732 €
	AS2C-118138BC	2,54	1380	2400	3.041 €	AS2C-118138BS	2,54	1380	2300	2.874 €
	AS2C-118138CC	2,78	1380	2600	3.184 €	AS2C-118138CS	2,78	1380	2500	3.015 €
AS3	AS3C-118158AC	2,70	1580	2200	3.094 €	AS3C-118158AS	2,70	1580	2100	2.895 €
	AS3C-118158BC	2,98	1580	2400	3.244 €	AS3C-118158BS	2,98	1580	2300	3.041 €
	AS3C-118158CC	3,25	1580	2600	3.399 €	AS3C-118158CS	3,25	1580	2500	3.197 €
AS4	AS4C-118178AC	3,10	1780	2200	3.283 €	AS4C-118178AS	3,10	1780	2100	3.050 €
	AS4C-118178BC	3,41	1780	2400	3.449 €	AS4C-118178BS	3,41	1780	2300	3.217 €
	AS4C-118178CC	3,72	1780	2600	3.611 €	AS4C-118178CS	3,72	1780	2500	3.379 €
AS5	AS5C-118198AC	3,49	1980	2200	3.477 €	AS5C-118198AS	3,49	1980	2100	3.205 €
	AS5C-118198BC	3,84	1980	2400	3.651 €	AS5C-118198BS	3,84	1980	2300	3.386 €
	AS5C-118198CC	4,19	1980	2600	3.827 €	AS5C-118198CS	4,19	1980	2500	3.560 €
AS6	AS6C-118218AC	3,88	2180	2200	3.663 €	AS6C-118218AS	3,88	2180	2100	3.365 €
	AS6C-118218BC	4,27	2180	2400	3.852 €	AS6C-118218BS	4,27	2180	2300	3.554 €
	AS6C-118218CC	4,66	2180	2600	4.039 €	AS6C-118218CS	4,66	2180	2500	3.742 €
AS7	AS7C-118238AC	4,27	2380	2200	3.858 €	AS7C-118238AS	4,27	2380	2100	3.522 €
	AS7C-118238BC	4,70	2380	2400	4.052 €	AS7C-118238BS	4,70	2380	2300	3.724 €
	AS7C-118238CC	5,13	2380	2600	4.253 €	AS7C-118238CS	5,13	2380	2500	3.923 €
AS8	AS8C-118258AC	4,66	2580	2200	4.046 €	AS8C-118258AS	4,66	2580	2100	3.679 €
	AS8C-118258BC	5,13	2580	2400	4.253 €	AS8C-118258BS	5,13	2580	2300	3.891 €
	AS8C-118258CC	5,60	2580	2600	4.466 €	AS8C-118258CS	5,60	2580	2500	4.097 €
AS9	AS9C-118278AC	5,06	2780	2200	4.234 €	AS9C-118278AS	5,06	2780	2100	3.838 €
	AS9C-118278BC	5,56	2780	2400	4.460 €	AS9C-118278BS	5,56	2780	2300	4.060 €
	AS9C-118278CC	6,07	2780	2600	4.682 €	AS9C-118278CS	6,07	2780	2500	4.280 €
AS10	AS10C-118298AC	5,45	2980	2200	4.428 €	AS10C-118298AS	5,45	2980	2100	3.994 €
	AS10C-118298BC	5,99	2980	2400	4.660 €	AS10C-118298BS	5,99	2980	2300	4.227 €
	AS10C-118298CC	6,54	2980	2600	4.894 €	AS10C-118298CS	6,54	2980	2500	4.460 €
AS11	AS11C-118318AC	5,84	3180	2200	4.614 €	AS11C-118318AS	5,84	3180	2100	4.150 €
	AS11C-118318BC	6,42	3180	2400	4.861 €	AS11C-118318BS	6,42	3180	2300	4.397 €
	AS11C-118318CC	7,01	3180	2600	4.979 €	AS11C-118318CS	7,01	3180	2500	4.642 €





80	Largo - Length (L)																			
	1140	1340	1540	1740	1940	2140	2340	2540	2740	2940	3140	3340	3540	3740	3940	4140	4340	4540	4740	4940
Fondo - Depth mm	1340	BS2	BS3	BS4	BS5	BS6	BS7	BS8	BS9	BS10	BS11	BS12								

80	CON suelo - WITH floor panel					SIN suelo - WITHOUT floor panel				
	COD	m²	L	H	€	COD	m²	L	H	€
BS2	BS2R-134134AC	2,78	1340	2160	2.829 €	BS2R-134134AS	2,78	1340	2080	2.629 €
	BS2R-134134BC	3,06	1340	2360	2.978 €	BS2R-134134BS	3,06	1340	2280	2.777 €
	BS2R-134134CC	3,34	1340	2560	3.120 €	BS2R-134134CS	3,34	1340	2480	2.919 €
BS3	BS3R-134154AC	3,26	1540	2160	3.025 €	BS3R-134154AS	3,26	1540	2080	2.785 €
	BS3R-134154BC	3,58	1540	2360	3.179 €	BS3R-134154BS	3,58	1540	2280	2.940 €
	BS3R-134154CC	3,91	1540	2560	3.335 €	BS3R-134154CS	3,91	1540	2480	3.094 €
BS4	BS4R-134174AC	3,73	1740	2160	3.217 €	BS4R-134174AS	3,73	1740	2080	2.940 €
	BS4R-134174BC	4,1	1740	2360	3.379 €	BS4R-134174BS	4,1	1740	2280	3.100 €
	BS4R-134174CC	4,47	1740	2560	3.548 €	BS4R-134174CS	4,47	1740	2480	3.269 €
BS5	BS5R-134194AC	4,2	1940	2160	3.404 €	BS5R-134194AS	4,2	1940	2080	3.094 €
	BS5R-134194BC	4,62	1940	2360	3.587 €	BS5R-134194BS	4,62	1940	2280	3.269 €
	BS5R-134194CC	5,04	1940	2560	3.761 €	BS5R-134194CS	5,04	1940	2480	3.444 €
BS6	BS6R-134214AC	4,67	2140	2160	3.600 €	BS6R-134214AS	4,67	2140	2080	3.244 €
	BS6R-134214BC	5,14	2140	2360	3.787 €	BS6R-134214BS	5,14	2140	2280	3.430 €
	BS6R-134214CC	5,61	2140	2560	3.976 €	BS6R-134214CS	5,61	2140	2480	3.618 €
BS7	BS7R-134234AC	5,14	2340	2160	3.793 €	BS7R-134234AS	5,14	2340	2080	3.399 €
	BS7R-134234BC	5,66	2340	2360	3.989 €	BS7R-134234BS	5,66	2340	2280	3.600 €
	BS7R-134234CC	6,17	2340	2560	4.190 €	BS7R-134234CS	6,17	2340	2480	3.801 €
BS8	BS8R-134254AC	5,62	2540	2160	3.982 €	BS8R-134254AS	5,62	2540	2080	3.554 €
	BS8R-134254BC	6,18	2540	2360	4.195 €	BS8R-134254BS	6,18	2540	2280	3.761 €
	BS8R-134254CC	6,74	2540	2560	4.402 €	BS8R-134254CS	6,74	2540	2480	3.976 €
BS9	BS9R-134274AC	6,09	2740	2160	4.176 €	BS9R-134274AS	6,09	2740	2080	3.709 €
	BS9R-134274BC	6,7	2740	2360	4.397 €	BS9R-134274BS	6,7	2740	2280	3.930 €
	BS9R-134274CC	7,31	2740	2560	4.614 €	BS9R-134274CS	7,31	2740	2480	4.150 €
BS10	BS10R-134294AC	6,56	2940	2160	4.370 €	BS10R-134294AS	6,56	2940	2080	3.858 €
	BS10R-134294BC	7,22	2940	2360	4.596 €	BS10R-134294BS	7,22	2940	2280	4.092 €
	BS10R-134294CC	7,87	2940	2560	4.830 €	BS10R-134294CS	7,87	2940	2480	4.326 €
BS11	BS11R-134314AC	7,03	3140	2160	4.558 €	BS11R-134314AS	7,03	3140	2080	4.013 €
	BS11R-134314BC	7,74	3140	2360	4.804 €	BS11R-134314BS	7,74	3140	2280	4.253 €
	BS11R-134314CC	8,44	3140	2560	5.042 €	BS11R-134314CS	8,44	3140	2480	4.500 €
BS12	BS12R-134334AC	7,5	3340	2160	4.752 €	BS12R-134334AS	7,5	3340	2080	4.169 €
	BS12R-134334BC	8,26	3340	2360	5.003 €	BS12R-134334BS	8,26	3340	2280	4.420 €
	BS12R-134334CC	9,01	3340	2560	5.257 €	BS12R-134334CS	9,01	3340	2480	4.673 €

100	Largo - Length (L)																			
	1180	1380	1580	1780	1980	2180	2380	2580	2780	2980	3180	3380	3580	3780	3980	4180	4380	4580	4780	4980
Fondo - Depth mm	1380	BS2	BS3	BS4	BS5	BS6	BS7	BS8	BS9	BS10	BS11	BS12								

100	CON suelo - WITH floor panel					SIN suelo - WITHOUT floor panel				
	COD	m²	L	H	€	COD	m²	L	H	€
BS2	BS2C-138138AC	2,78	1380	2200	3.107 €	BS2C-138138AS	2,78	1380	2100	2.900 €
	BS2C-138138BC	3,06	1380	2400	3.256 €	BS2C-138138BS	3,06	1380	2300	3.050 €
	BS2C-138138CC	3,34	1380	2600	3.411 €	BS2C-138138CS	3,34	1380	2500	3.205 €
BS3	BS3C-138158AC	3,26	1580	2200	3.307 €	BS3C-138158AS	3,26	1580	2100	3.061 €
	BS3C-138158BC	3,58	1580	2400	3.477 €	BS3C-138158BS	3,58	1580	2300	3.223 €
	BS3C-138158CC	3,91	1580	2600	3.639 €	BS3C-138158CS	3,91	1580	2500	3.392 €
BS4	BS4C-138178AC	3,73	1780	2200	3.516 €	BS4C-138178AS	3,73	1780	2100	3.223 €
	BS4C-138178BC	4,10	1780	2400	3.689 €	BS4C-138178BS	4,1	1780	2300	3.399 €
	BS4C-138178CC	4,47	1780	2600	3.865 €	BS4C-138178CS	4,47	1780	2500	3.573 €
BS5	BS5C-138198AC	4,20	1980	2200	3.715 €	BS5C-138198AS	4,2	1980	2100	3.386 €
	BS5C-138198BC	4,62	1980	2400	3.905 €	BS5C-138198BS	4,62	1980	2300	3.573 €
	BS5C-138198CC	5,04	1980	2600	4.092 €	BS5C-138198CS	5,04	1980	2500	3.761 €
BS6	BS6C-138218AC	4,67	2180	2200	3.915 €	BS6C-138218AS	4,67	2180	2100	3.548 €
	BS6C-138218BC	5,14	2180	2400	4.117 €	BS6C-138218BS	5,14	2180	2300	3.748 €
	BS6C-138218CC	5,61	2180	2600	4.318 €	BS6C-138218CS	5,61	2180	2500	3.949 €
BS7	BS7C-138238AC	5,14	2380	2200	4.123 €	BS7C-138238AS	5,14	2380	2100	3.715 €
	BS7C-138238BC	5,66	2380	2400	4.331 €	BS7C-138238BS	5,66	2380	2300	3.923 €
	BS7C-138238CC	6,17	2380	2600	4.544 €	BS7C-138238CS	6,17	2380	2500	4.137 €
BS8	BS8C-138258AC	5,62	2580	2200	4.326 €	BS8C-138258AS	5,62	2580	2100	3.878 €
	BS8C-138258BC	6,18	2580	2400	4.552 €	BS8C-138258BS	6,18	2580	2300	4.097 €
	BS8C-138258CC	6,74	2580	2600	4.770 €	BS8C-138258CS	6,74	2580	2500	4.326 €
BS9	BS9C-138278AC	6,09	2780	2200	4.531 €	BS9C-138278AS	6,09	2780	2100	4.039 €
	BS9C-138278BC	6,70	2780	2400	4.765 €	BS9C-138278BS	6,7	2780	2300	4.272 €
	BS9C-138278CC	7,31	2780	2600	4.997 €	BS9C-138278CS	7,31	2780	2500	4.512 €
BS10	BS10C-138298AC	6,56	2980	2200	4.732 €	BS10C-138298AS	6,56	2980	2100	4.201 €
	BS10C-138298BC	7,22	2980	2400	4.979 €	BS10C-138298BS	7,22	2980	2300	4.448 €
	BS10C-138298CC	7,87	2980	2600	5.224 €	BS10C-138298CS	7,87	2980	2500	4.693 €
BS11	BS11C-138318AC	7,03	3180	2200	4.933 €	BS11C-138318AS	7,03	3180	2100	4.370 €
	BS11C-138318BC	7,74	3180	2400	5.192 €	BS11C-138318BS	7,74	3180	2300	4.622 €
	BS11C-138318CC	8,44	3180	2600	5.451 €	BS11C-138318CS	8,44	3180	2500	4.881 €
BS12	BS12C-138338AC	7,50	3380	2200	5.141 €	BS12C-138338AS	7,5	3380	2100	4.531 €
	BS12C-138338BC	8,26	3380	2400	5.406 €	BS12C-138338BS	8,26	3380	2300	4.804 €
	BS12C-138338CC	9,01	3380	2600	5.677 €	BS12C-138338CS	9,01	3380	2500	5.069 €





80	Largo - Length (L)																				
	1140	1340	1540	1740	1940	2140	2340	2540	2740	2940	3140	3340	3540	3740	3940	4140	4340	4540	4740	4940	
Fondo - Depth mm 1540				CS3	CS4	CS5	CS6	CS7	CS8	CS9	CS10	CS11	CS12	CS13							

80	CON suelo - WITH floor panel					SIN suelo - WITHOUT floor panel				
	COD	m²	L	H	€	COD	m²	L	H	€
CS3	CS3R-154154AC	3,81	1540	2160	3.231 €	CS3R-154154AS	3,81	1540	2080	2.946 €
	CS3R-154154BC	4,19	1540	2360	3.392 €	CS3R-154154BS	4,19	1540	2280	3.107 €
	CS3R-154154CC	4,57	1540	2560	3.560 €	CS3R-154154CS	4,57	1540	2480	3.275 €
CS4	CS4R-154174AC	4,36	1740	2160	3.430 €	CS4R-154174AS	4,36	1740	2080	3.100 €
	CS4R-154174BC	4,8	1740	2360	3.611 €	CS4R-154174BS	4,8	1740	2280	3.283 €
	CS4R-154174CC	5,23	1740	2560	3.787 €	CS4R-154174CS	5,23	1740	2480	3.457 €
CS5	CS5R-154194AC	4,91	1940	2160	3.639 €	CS5R-154194AS	4,91	1940	2080	3.262 €
	CS5R-154194BC	5,4	1940	2360	3.827 €	CS5R-154194BS	5,4	1940	2280	3.449 €
	CS5R-154194CC	5,9	1940	2560	4.013 €	CS5R-154194CS	5,9	1940	2480	3.639 €
CS6	CS6R-154214AC	5,46	2140	2160	3.845 €	CS6R-154214AS	5,46	2140	2080	3.424 €
	CS6R-154214BC	6,01	2140	2360	4.039 €	CS6R-154214BS	6,01	2140	2280	3.618 €
	CS6R-154214CC	6,56	2140	2560	4.241 €	CS6R-154214CS	6,56	2140	2480	3.819 €
CS7	CS7R-154234AC	6,02	2340	2160	4.046 €	CS7R-154234AS	6,02	2340	2080	3.579 €
	CS7R-154234BC	6,62	2340	2360	4.253 €	CS7R-154234BS	6,62	2340	2280	3.793 €
	CS7R-154234CC	7,22	2340	2560	4.466 €	CS7R-154234CS	7,22	2340	2480	3.999 €
CS8	CS8R-154254AC	6,57	2540	2160	4.247 €	CS8R-154254AS	6,57	2540	2080	3.742 €
	CS8R-154254BC	7,23	2540	2360	4.466 €	CS8R-154254BS	7,23	2540	2280	3.961 €
	CS8R-154254CC	7,88	2540	2560	4.693 €	CS8R-154254CS	7,88	2540	2480	4.181 €
CS9	CS9R-154274AC	7,12	2740	2160	4.454 €	CS9R-154274AS	7,12	2740	2080	3.897 €
	CS9R-154274BC	7,83	2740	2360	4.687 €	CS9R-154274BS	7,83	2740	2280	4.131 €
	CS9R-154274CC	8,54	2740	2560	4.919 €	CS9R-154274CS	8,54	2740	2480	4.363 €
CS10	CS10R-154294AC	7,67	2940	2160	4.660 €	CS10R-154294AS	7,67	2940	2080	4.060 €
	CS10R-154294BC	8,44	2940	2360	4.901 €	CS10R-154294BS	8,44	2940	2280	4.299 €
	CS10R-154294CC	9,21	2940	2560	5.146 €	CS10R-154294CS	9,21	2940	2480	4.544 €
CS11	CS11R-154314AC	8,22	3140	2160	4.861 €	CS11R-154314AS	8,22	3140	2080	4.215 €
	CS11R-154314BC	9,05	3140	2360	5.114 €	CS11R-154314BS	9,05	3140	2280	4.466 €
	CS11R-154314CC	9,87	3140	2560	5.372 €	CS11R-154314CS	9,87	3140	2480	4.725 €
CS12	CS12R-154334AC	8,78	3340	2160	5.069 €	CS12R-154334AS	8,78	3340	2080	4.377 €
	CS12R-154334BC	9,65	3340	2360	5.327 €	CS12R-154334BS	9,65	3340	2280	4.642 €
	CS12R-154334CC	10,53	3340	2560	5.594 €	CS12R-154334CS	10,53	3340	2480	4.907 €
CS13	CS13R-154354AC	9,33	3540	2160	5.269 €	CS13R-154354AS	9,33	3540	2080	4.539 €
	CS13R-154354BC	10,26	3540	2360	5.548 €	CS13R-154354BS	10,26	3540	2280	4.809 €
	CS13R-154354CC	11,19	3540	2560	5.818 €	CS13R-154354CS	11,19	3540	2480	5.088 €

100	Largo - Length (L)																				
	1180	1380	1580	1780	1980	2180	2380	2580	2780	2980	3180	3380	3580	3780	3980	4180	4380	4580	4780	4980	
Fondo - Depth mm 1580				CS3	CS4	CS5	CS6	CS7	CS8	CS9	CS10	CS11	CS12	CS13							

100	CON suelo - WITH floor panel					SIN suelo - WITHOUT floor panel				
	COD	m²	L	H	€	COD	m²	L	H	€
CS3	CS3C-158158AC	3,81	1580	2200	3.528 €	CS3C-158158AS	3,81	1580	2100	3.231 €
	CS3C-158158BC	4,19	1580	2400	3.703 €	CS3C-158158BS	4,19	1580	2300	3.404 €
	CS3C-158158CC	4,57	1580	2600	3.878 €	CS3C-158158CS	4,57	1580	2500	3.587 €
CS4	CS4C-158178AC	4,36	1780	2200	3.742 €	CS4C-158178AS	4,36	1780	2100	3.399 €
	CS4C-158178BC	4,80	1780	2400	3.930 €	CS4C-158178BS	4,80	1780	2300	3.587 €
	CS4C-158178CC	5,23	1780	2600	4.117 €	CS4C-158178CS	5,23	1780	2500	3.774 €
CS5	CS5C-158198AC	4,91	1980	2200	3.961 €	CS5C-158198AS	4,91	1980	2100	3.567 €
	CS5C-158198BC	5,40	1980	2400	4.156 €	CS5C-158198BS	5,40	1980	2300	3.767 €
	CS5C-158198CC	5,90	1980	2600	4.356 €	CS5C-158198CS	5,90	1980	2500	3.967 €
CS6	CS6C-158218AC	5,46	2180	2200	4.176 €	CS6C-158218AS	5,46	2180	2100	3.735 €
	CS6C-158218BC	6,01	2180	2400	4.388 €	CS6C-158218BS	6,01	2180	2300	3.949 €
	CS6C-158218CC	6,56	2180	2600	4.596 €	CS6C-158218CS	6,56	2180	2500	4.156 €
CS7	CS7C-158238AC	6,02	2380	2200	4.388 €	CS7C-158238AS	6,02	2380	2100	3.905 €
	CS7C-158238BC	6,62	2380	2400	4.614 €	CS7C-158238BS	6,62	2380	2300	4.131 €
	CS7C-158238CC	7,22	2380	2600	4.836 €	CS7C-158238CS	7,22	2380	2500	4.349 €
CS8	CS8C-158258AC	6,57	2580	2200	4.609 €	CS8C-158258AS	6,57	2580	2100	4.078 €
	CS8C-158258BC	7,23	2580	2400	4.843 €	CS8C-158258BS	7,23	2580	2300	4.309 €
	CS8C-158258CC	7,88	2580	2600	5.075 €	CS8C-158258CS	7,88	2580	2500	4.544 €
CS9	CS9C-158278AC	7,12	2780	2200	4.822 €	CS9C-158278AS	7,12	2780	2100	4.247 €
	CS9C-158278BC	7,83	2780	2400	5.069 €	CS9C-158278BS	7,83	2780	2300	4.493 €
	CS9C-158278CC	8,54	2780	2600	5.315 €	CS9C-158278CS	8,54	2780	2500	4.738 €
CS10	CS10C-158298AC	7,67	2980	2200	5.036 €	CS10C-158298AS	7,67	2980	2100	4.415 €
	CS10C-158298BC	8,44	2980	2400	5.296 €	CS10C-158298BS	8,44	2980	2300	4.668 €
	CS10C-158298CC	9,21	2980	2600	5.554 €	CS10C-158298CS	9,21	2980	2500	4.926 €
CS11	CS11C-158318AC	8,22	3180	2200	5.257 €	CS11C-158318AS	8,22	3180	2100	4.584 €
	CS11C-158318BC	9,05	3180	2400	5.522 €	CS11C-158318BS	9,05	3180	2300	4.849 €
	CS11C-158318CC	9,87	3180	2600	5.794 €	CS11C-158318CS	9,87	3180	2500	5.119 €
CS12	CS12C-158338AC	8,78	3380	2200	5.469 €	CS12C-158338AS	8,78	3380	2100	4.752 €
	CS12C-158338BC	9,65	3380	2400	5.755 €	CS12C-158338BS	9,65	3380	2300	5.031 €
	CS12C-158338CC	10,53	3380	2600	6.156 €	CS12C-158338CS	10,53	3380	2500	5.315 €
CS13	CS13C-158358AC	9,33	3580	2200	5.690 €	CS13C-158358AS	9,33	3580	2100	4.919 €
	CS13C-158358BC	10,26	3580	2400	6.104 €	CS13C-158358BS	10,26	3580	2300	5.212 €
	CS13C-158358CC	11,19	3580	2600	6.396 €	CS13C-158358CS	11,19	3580	2500	5.502 €





80	Largo - Length (L)																				
	1140	1340	1540	1740	1940	2140	2340	2540	2740	2940	3140	3340	3540	3740	3940	4140	4340	4540	4740	4940	
Fondo - Depth mm 1740				DS4	DS5	DS6	DS7	DS8	DS9	DS10	DS11	DS12	DS13	DS14							

80	CON suelo - WITH floor panel					SIN suelo - WITHOUT floor panel				
	COD	m²	L	H	€	COD	m²	L	H	€
DS4	DS4R-174174AC	4,99	1740	2160	3.651 €	DS4R-174174AS	4,99	1740	2080	3.269 €
	DS4R-174174BC	5,49	1740	2360	3.838 €	DS4R-174174BS	5,49	1740	2280	3.457 €
	DS4R-174174CC	5,99	1740	2560	4.027 €	DS4R-174174CS	5,99	1740	2480	3.645 €
DS5	DS5R-174194AC	5,62	1940	2160	3.865 €	DS5R-174194AS	5,62	1940	2080	3.430 €
	DS5R-174194BC	6,19	1940	2360	4.065 €	DS5R-174194BS	6,19	1940	2280	3.632 €
	DS5R-174194CC	6,75	1940	2560	4.264 €	DS5R-174194CS	6,75	1940	2480	3.832 €
DS6	DS6R-174214AC	6,26	2140	2160	4.084 €	DS6R-174214AS	6,26	2140	2080	3.600 €
	DS6R-174214BC	6,88	2140	2360	4.293 €	DS6R-174214BS	6,88	2140	2280	3.807 €
	DS6R-174214CC	7,51	2140	2560	4.505 €	DS6R-174214CS	7,51	2140	2480	4.013 €
DS7	DS7R-174234AC	6,89	2340	2160	4.299 €	DS7R-174234AS	6,89	2340	2080	3.761 €
	DS7R-174234BC	7,58	2340	2360	4.518 €	DS7R-174234BS	7,58	2340	2280	3.982 €
	DS7R-174234CC	8,27	2340	2560	4.738 €	DS7R-174234CS	8,27	2340	2480	4.201 €
DS8	DS8R-174254AC	7,52	2540	2160	4.518 €	DS8R-174254AS	7,52	2540	2080	3.923 €
	DS8R-174254BC	8,27	2540	2360	4.746 €	DS8R-174254BS	8,27	2540	2280	4.156 €
	DS8R-174254CC	9,02	2540	2560	4.854 €	DS8R-174254CS	9,02	2540	2480	4.388 €
DS9	DS9R-174274AC	8,15	2740	2160	4.732 €	DS9R-174274AS	8,15	2740	2080	4.092 €
	DS9R-174274BC	8,97	2740	2360	4.972 €	DS9R-174274BS	8,97	2740	2280	4.331 €
	DS9R-174274CC	9,78	2740	2560	5.217 €	DS9R-174274CS	9,78	2740	2480	4.579 €
DS10	DS10R-174294AC	8,78	2940	2160	4.947 €	DS10R-174294AS	8,78	2940	2080	4.253 €
	DS10R-174294BC	9,66	2940	2360	5.204 €	DS10R-174294BS	9,66	2940	2280	4.512 €
	DS10R-174294CC	10,54	2940	2560	5.457 €	DS10R-174294CS	10,54	2940	2480	4.765 €
DS11	DS11R-174314AC	9,42	3140	2160	5.164 €	DS11R-174314AS	9,42	3140	2080	4.415 €
	DS11R-174314BC	10,36	3140	2360	5.430 €	DS11R-174314BS	10,36	3140	2280	4.687 €
	DS11R-174314CC	11,3	3140	2560	5.696 €	DS11R-174314CS	11,3	3140	2480	4.952 €
DS12	DS12R-174334AC	10,05	3340	2160	5.379 €	DS12R-174334AS	10,05	3340	2080	4.584 €
	DS12R-174334BC	11,05	3340	2360	5.657 €	DS12R-174334BS	11,05	3340	2280	4.861 €
	DS12R-174334CC	12,06	3340	2560	5.936 €	DS12R-174334CS	12,06	3340	2480	5.134 €
DS13	DS13R-174354AC	10,68	3540	2160	5.600 €	DS13R-174354AS	10,68	3540	2080	4.752 €
	DS13R-174354BC	11,75	3540	2360	5.886 €	DS13R-174354BS	11,75	3540	2280	5.036 €
	DS13R-174354CC	12,82	3540	2560	6.176 €	DS13R-174354CS	12,82	3540	2480	5.322 €
DS14	DS14R-174374AC	11,31	3740	2160	5.813 €	DS14R-174374AS	11,31	3740	2080	4.912 €
	DS14R-174374BC	12,44	3740	2360	6.112 €	DS14R-174374BS	12,44	3740	2280	5.212 €
	DS14R-174374CC	13,58	3740	2560	6.396 €	DS14R-174374CS	13,58	3740	2480	5.508 €

100	Largo - Length (L)																				
	1180	1380	1580	1780	1980	2180	2380	2580	2780	2980	3180	3380	3580	3780	3980	4180	4380	4580	4780	4980	
Fondo - Depth mm 1780				DS4	DS5	DS6	DS7	DS8	DS9	DS10	DS11	DS12	DS13	DS14							

100	CON suelo - WITH floor panel					SIN suelo - WITHOUT floor panel				
	COD	m²	L	H	€	COD	m²	L	H	€
DS4	DS4C-178178AC	4,99	1780	2200	3.976 €	DS4C-178178AS	4,99	1780	2100	3.573 €
	DS4C-178178BC	5,49	1780	2400	4.169 €	DS4C-178178BS	5,49	1780	2300	3.774 €
	DS4C-178178CC	5,99	1780	2600	4.370 €	DS4C-178178CS	5,99	1780	2500	3.976 €
DS5	DS5C-178198AC	5,62	1980	2200	4.201 €	DS5C-178198AS	5,62	1980	2100	3.748 €
	DS5C-178198BC	6,19	1980	2400	4.409 €	DS5C-178198BS	6,19	1980	2300	3.961 €
	DS5C-178198CC	6,75	1980	2600	4.622 €	DS5C-178198CS	6,75	1980	2500	4.169 €
DS6	DS6C-178218AC	6,26	2180	2200	4.428 €	DS6C-178218AS	6,26	2180	2100	3.923 €
	DS6C-178218BC	6,88	2180	2400	4.653 €	DS6C-178218BS	6,88	2180	2300	4.143 €
	DS6C-178218CC	7,51	2180	2600	4.874 €	DS6C-178218CS	7,51	2180	2500	4.370 €
DS7	DS7C-178238AC	6,89	2380	2200	4.660 €	DS7C-178238AS	6,89	2380	2100	4.097 €
	DS7C-178238BC	7,58	2380	2400	4.894 €	DS7C-178238BS	7,58	2380	2300	4.331 €
	DS7C-178238CC	8,27	2380	2600	5.126 €	DS7C-178238CS	8,27	2380	2500	4.564 €
DS8	DS8C-178258AC	7,52	2580	2200	4.888 €	DS8C-178258AS	7,52	2580	2100	4.272 €
	DS8C-178258BC	8,27	2580	2400	5.134 €	DS8C-178258BS	8,27	2580	2300	4.518 €
	DS8C-178258CC	9,02	2580	2600	5.379 €	DS8C-178258CS	9,02	2580	2500	4.765 €
DS9	DS9C-178278AC	8,15	2780	2200	5.114 €	DS9C-178278AS	8,15	2780	2100	4.448 €
	DS9C-178278BC	8,97	2780	2400	5.372 €	DS9C-178278BS	8,97	2780	2300	4.708 €
	DS9C-178278CC	9,78	2780	2600	5.633 €	DS9C-178278CS	9,78	2780	2500	4.965 €
DS10	DS10C-178298AC	8,78	2980	2200	5.346 €	DS10C-178298AS	8,78	2980	2100	4.622 €
	DS10C-178298BC	9,66	2980	2400	5.612 €	DS10C-178298BS	9,66	2980	2300	4.894 €
	DS10C-178298CC	10,54	2980	2600	6.008 €	DS10C-178298CS	10,54	2980	2500	5.159 €
DS11	DS11C-178318AC	9,42	3180	2200	5.573 €	DS11C-178318AS	9,42	3180	2100	4.797 €
	DS11C-178318BC	10,36	3180	2400	5.858 €	DS11C-178318BS	10,36	3180	2300	5.075 €
	DS11C-178318CC	11,30	3180	2600	6.260 €	DS11C-178318CS	11,3	3180	2500	5.361 €
DS12	DS12C-178338AC	10,05	3380	2200	5.807 €	DS12C-178338AS	10,05	3380	2100	4.972 €
	DS12C-178338BC	11,05	3380	2400	6.222 €	DS12C-178338BS	11,05	3380	2300	5.262 €
	DS12C-178338CC	12,06	3380	2600	6.511 €	DS12C-178338CS	12,06	3380	2500	5.554 €
DS13	DS13C-178358AC	10,68	3580	2200	6.156 €	DS13C-178358AS	10,68	3580	2100	5.146 €
	DS13C-178358BC	11,75	3580	2400	6.461 €	DS13C-178358BS	11,75	3580	2300	5.451 €
	DS13C-178358CC	12,82	3580	2600	6.765 €	DS13C-178358CS	12,82	3580	2500	5.755 €
DS14	DS14C-178378AC	11,31	3780	2200	6.382 €	DS14C-178378AS	11,31	3780	2100	5.322 €
	DS14C-178378BC	12,44	3780	2400	6.700 €	DS14C-178378BS	12,44	3780	2300	5.638 €
	DS14C-178378CC	13,58	3780	2600	6.875 €	DS14C-178378CS	13,58	3780	2500	6.077 €





80	Largo - Length (L)																			
	1140	1340	1540	1740	1940	2140	2340	2540	2740	2940	3140	3340	3540	3740	3940	4140	4340	4540	4740	4940
				ES5	ES6	ES7	ES8	ES9	ES10	ES11	ES12	ES13	ES14	ES15						

80	CON suelo - WITH floor panel					SIN suelo - WITHOUT floor panel				
	COD	m²	L	H	€	COD	m²	L	H	€
ES5	ES5R-194194AC	6,34	1940	2160	4.097 €	ES5R-194194AS	6,34	1940	2080	3.605 €
	ES5R-194194BC	6,97	1940	2360	4.304 €	ES5R-194194BS	6,97	1940	2280	3.812 €
	ES5R-194194CC	7,6	1940	2560	4.512 €	ES5R-194194CS	7,6	1940	2480	4.020 €
ES6	ES6R-194214AC	7,05	2140	2160	4.326 €	ES6R-194214AS	7,05	2140	2080	3.774 €
	ES6R-194214BC	7,75	2140	2360	4.544 €	ES6R-194214BS	7,75	2140	2280	3.994 €
	ES6R-194214CC	8,46	2140	2560	4.765 €	ES6R-194214CS	8,46	2140	2480	4.215 €
ES7	ES7R-194234AC	7,76	2340	2160	4.552 €	ES7R-194234AS	7,76	2340	2080	3.942 €
	ES7R-194234BC	8,54	2340	2360	4.784 €	ES7R-194234BS	8,54	2340	2280	4.176 €
	ES7R-194234CC	9,31	2340	2560	5.017 €	ES7R-194234CS	9,31	2340	2480	4.409 €
ES8	ES8R-194254AC	8,47	2540	2160	4.784 €	ES8R-194254AS	8,47	2540	2080	4.111 €
	ES8R-194254BC	9,32	2540	2360	5.023 €	ES8R-194254BS	9,32	2540	2280	4.356 €
	ES8R-194254CC	10,17	2540	2560	5.269 €	ES8R-194254CS	10,17	2540	2480	4.596 €
ES9	ES9R-194274AC	9,18	2740	2160	5.010 €	ES9R-194274AS	9,18	2740	2080	4.280 €
	ES9R-194274BC	10,1	2740	2360	5.262 €	ES9R-194274BS	10,1	2740	2280	4.539 €
	ES9R-194274CC	11,02	2740	2560	5.515 €	ES9R-194274CS	11,02	2740	2480	4.791 €
ES10	ES10R-194294AC	9,9	2940	2160	5.238 €	ES10R-194294AS	9,9	2940	2080	4.454 €
	ES10R-194294BC	10,89	2940	2360	5.502 €	ES10R-194294BS	10,89	2940	2280	4.719 €
	ES10R-194294CC	11,88	2940	2560	5.767 €	ES10R-194294CS	11,88	2940	2480	4.985 €
ES11	ES11R-194314AC	10,61	3140	2160	5.469 €	ES11R-194314AS	10,61	3140	2080	4.622 €
	ES11R-194314BC	11,67	3140	2360	5.743 €	ES11R-194314BS	11,67	3140	2280	4.901 €
	ES11R-194314CC	12,73	3140	2560	6.020 €	ES11R-194314CS	12,73	3140	2480	5.172 €
ES12	ES12R-194334AC	11,32	3340	2160	5.696 €	ES12R-194334AS	11,32	3340	2080	4.791 €
	ES12R-194334BC	12,45	3340	2360	5.982 €	ES12R-194334BS	12,45	3340	2280	5.081 €
	ES12R-194334CC	13,58	3340	2560	6.272 €	ES12R-194334CS	13,58	3340	2480	5.367 €
ES13	ES13R-194354AC	12,03	3540	2160	5.930 €	ES13R-194354AS	12,03	3540	2080	4.965 €
	ES13R-194354BC	13,24	3540	2360	6.227 €	ES13R-194354BS	13,24	3540	2280	5.262 €
	ES13R-194354CC	14,44	3540	2560	6.506 €	ES13R-194354CS	14,44	3540	2480	5.561 €
ES14	ES14R-194374AC	12,74	3740	2160	6.156 €	ES14R-194374AS	12,74	3740	2080	5.134 €
	ES14R-194374BC	14,02	3740	2360	6.454 €	ES14R-194374BS	14,02	3740	2280	5.445 €
	ES14R-194374CC	15,29	3740	2560	6.752 €	ES14R-194374CS	15,29	3740	2480	5.750 €
ES15	ES15R-194394AC	13,46	3940	2160	6.382 €	ES15R-194394AS	13,46	3940	2080	5.301 €
	ES15R-194394BC	14,8	3940	2360	6.687 €	ES15R-194394BS	14,8	3940	2280	5.619 €
	ES15R-194394CC	16,15	3940	2560	6.999 €	ES15R-194394CS	16,15	3940	2480	5.943 €

100	Largo - Length (L)																			
	1180	1380	1580	1780	1980	2180	2380	2580	2780	2980	3180	3380	3580	3780	3980	4180	4380	4580	4780	4980
				ES5	ES6	ES7	ES8	ES9	ES10	ES11	ES12	ES13	ES14	ES15						

100	CON suelo - WITH floor panel					SIN suelo - WITHOUT floor panel				
	COD	m²	L	H	€	COD	m²	L	H	€
ES5	ES5C-198198AC	6,34	1980	2200	4.441 €	ES5C-198198AS	6,34	1980	2100	3.930 €
	ES5C-198198BC	6,97	1980	2400	4.668 €	ES5C-198198BS	6,97	1980	2300	4.150 €
	ES5C-198198CC	7,60	1980	2600	4.888 €	ES5C-198198CS	7,6	1980	2500	4.377 €
ES6	ES6C-198218AC	7,05	2180	2200	4.687 €	ES6C-198218AS	7,05	2180	2100	4.111 €
	ES6C-198218BC	7,75	2180	2400	4.919 €	ES6C-198218BS	7,75	2180	2300	4.344 €
	ES6C-198218CC	8,46	2180	2600	5.154 €	ES6C-198218CS	8,46	2180	2500	4.579 €
ES7	ES7C-198238AC	7,76	2380	2200	4.926 €	ES7C-198238AS	7,76	2380	2100	4.293 €
	ES7C-198238BC	8,54	2380	2400	5.172 €	ES7C-198238BS	8,54	2380	2300	4.539 €
	ES7C-198238CC	9,31	2380	2600	5.418 €	ES7C-198238CS	9,31	2380	2500	4.784 €
ES8	ES8C-198258AC	8,47	2580	2200	5.172 €	ES8C-198258AS	8,47	2580	2100	4.471 €
	ES8C-198258BC	9,32	2580	2400	5.424 €	ES8C-198258BS	9,32	2580	2300	4.725 €
	ES8C-198258CC	10,17	2580	2600	5.684 €	ES8C-198258CS	10,17	2580	2500	4.985 €
ES9	ES9C-198278AC	9,18	2780	2200	5.412 €	ES9C-198278AS	9,18	2780	2100	4.653 €
	ES9C-198278BC	10,10	2780	2400	5.684 €	ES9C-198278BS	10,1	2780	2300	4.919 €
	ES9C-198278CC	11,02	2780	2600	6.072 €	ES9C-198278CS	11,02	2780	2500	5.192 €
ES10	ES10C-198298AC	9,90	2980	2200	5.651 €	ES10C-198298AS	9,9	2980	2100	4.830 €
	ES10C-198298BC	10,89	2980	2400	6.060 €	ES10C-198298BS	10,89	2980	2300	5.114 €
	ES10C-198298CC	11,88	2980	2600	6.338 €	ES10C-198298CS	11,88	2980	2500	5.392 €
ES11	ES11C-198318AC	10,61	3180	2200	6.020 €	ES11C-198318AS	10,61	3180	2100	5.010 €
	ES11C-198318BC	11,67	3180	2400	6.311 €	ES11C-198318BS	11,67	3180	2300	5.308 €
	ES11C-198318CC	12,73	3180	2600	6.603 €	ES11C-198318CS	12,73	3180	2500	5.600 €
ES12	ES12C-198338AC	11,32	3380	2200	6.260 €	ES12C-198338AS	11,32	3380	2100	5.192 €
	ES12C-198338BC	12,45	3380	2400	6.565 €	ES12C-198338BS	12,45	3380	2300	5.496 €
	ES12C-198338CC	13,58	3380	2600	6.870 €	ES12C-198338CS	13,58	3380	2500	5.600 €
ES13	ES13C-198358AC	12,03	3580	2200	6.506 €	ES13C-198358AS	12,03	3580	2100	5.372 €
	ES13C-198358BC	13,24	3580	2400	6.816 €	ES13C-198358BS	13,24	3580	2300	5.690 €
	ES13C-198358CC	14,44	3580	2600	7.130 €	ES13C-198358CS	14,44	3580	2500	5.985 €
ES14	ES14C-198378AC	12,74	3780	2200	6.746 €	ES14C-198378AS	12,74	3780	2100	5.554 €
	ES14C-198378BC	14,02	3780	2400	7.066 €	ES14C-198378BS	14,02	3780	2300	5.868 €
	ES14C-198378CC	15,29	3780	2600	7.390 €	ES14C-198378CS	15,29	3780	2500	6.198 €
ES15	ES15C-198398AC	13,46	3980	2200	6.843 €	ES15C-198398AS	13,46	3980	2100	5.735 €
	ES15C-198398BC	14,80	3980	2400	7.173 €	ES15C-198398BS	14,8	3980	2300	6.119 €
	ES15C-198398CC	16,15	3980	2600	7.503 €	ES15C-198398CS	16,15	3980	2500	6.538 €





80	Largo - Length (L)																				
	1140	1340	1540	1740	1940	2140	2340	2540	2740	2940	3140	3340	3540	3740	3940	4140	4340	4540	4740	4940	
Fondo - Depth mm 2140						FS6	FS7	FS8	FS9	FS10	FS11	FS12	FS13	FS14	FS15	FS16					

80	CON suelo - WITH floor panel					SIN suelo - WITHOUT floor panel				
	COD	m²	L	H	€	COD	m²	L	H	€
FS6	FS6R-214214AC	7,84	2140	2160	4.564 €	FS6R-214214AS	7,84	2140	2080	3.949 €
	FS6R-214214BC	8,62	2140	2360	4.797 €	FS6R-214214BS	8,62	2140	2280	4.181 €
	FS6R-214214CC	9,41	2140	2560	5.031 €	FS6R-214214CS	9,41	2140	2480	4.409 €
FS7	FS7R-214234AC	8,63	2340	2160	4.804 €	FS7R-214234AS	8,63	2340	2080	4.123 €
	FS7R-214234BC	9,5	2340	2360	5.049 €	FS7R-214234BS	9,5	2340	2280	4.370 €
	FS7R-214234CC	10,36	2340	2560	5.296 €	FS7R-214234CS	10,36	2340	2480	4.609 €
FS8	FS8R-214254AC	9,42	2540	2160	5.049 €	FS8R-214254AS	9,42	2540	2080	4.299 €
	FS8R-214254BC	10,37	2540	2360	5.301 €	FS8R-214254BS	10,37	2540	2280	4.552 €
	FS8R-214254CC	11,31	2540	2560	5.554 €	FS8R-214254CS	11,31	2540	2480	4.804 €
FS9	FS9R-214274AC	10,22	2740	2160	5.289 €	FS9R-214274AS	10,22	2740	2080	4.471 €
	FS9R-214274BC	11,24	2740	2360	5.554 €	FS9R-214274BS	11,24	2740	2280	4.738 €
	FS9R-214274CC	12,26	2740	2560	5.818 €	FS9R-214274CS	12,26	2740	2480	5.003 €
FS10	FS10R-214294AC	11,01	2940	2160	5.528 €	FS10R-214294AS	11,01	2940	2080	4.648 €
	FS10R-214294BC	12,11	2940	2360	5.807 €	FS10R-214294BS	12,11	2940	2280	4.926 €
	FS10R-214294CC	13,21	2940	2560	6.084 €	FS10R-214294CS	13,21	2940	2480	5.198 €
FS11	FS11R-214314AC	11,8	3140	2160	5.774 €	FS11R-214314AS	11,8	3140	2080	4.822 €
	FS11R-214314BC	12,98	3140	2360	6.060 €	FS11R-214314BS	12,98	3140	2280	5.114 €
	FS11R-214314CC	14,16	3140	2560	6.343 €	FS11R-214314CS	14,16	3140	2480	5.400 €
FS12	FS12R-214334AC	12,59	3340	2160	6.014 €	FS12R-214334AS	12,59	3340	2080	5.003 €
	FS12R-214334BC	13,85	3340	2360	6.311 €	FS12R-214334BS	13,85	3340	2280	5.301 €
	FS12R-214334CC	15,11	3340	2560	6.590 €	FS12R-214334CS	15,11	3340	2480	5.600 €
FS13	FS13R-214354AC	13,38	3540	2160	6.254 €	FS13R-214354AS	13,38	3540	2080	5.178 €
	FS13R-214354BC	14,72	3540	2360	6.545 €	FS13R-214354BS	14,72	3540	2280	5.484 €
	FS13R-214354CC	16,06	3540	2560	6.849 €	FS13R-214354CS	16,06	3540	2480	5.794 €
FS14	FS14R-214374AC	14,18	3740	2160	6.481 €	FS14R-214374AS	14,18	3740	2080	5.354 €
	FS14R-214374BC	15,59	3740	2360	6.798 €	FS14R-214374BS	15,59	3740	2280	5.671 €
	FS14R-214374CC	17,01	3740	2560	7.108 €	FS14R-214374CS	17,01	3740	2480	5.994 €
FS15	FS15R-214394AC	14,97	3940	2160	6.719 €	FS15R-214394AS	14,97	3940	2080	5.528 €
	FS15R-214394BC	16,47	3940	2360	7.037 €	FS15R-214394BS	16,47	3940	2280	5.858 €
	FS15R-214394CC	17,96	3940	2560	7.367 €	FS15R-214394CS	17,96	3940	2480	6.188 €
FS16	FS16R-214414AC	15,76	4140	2160	6.954 €	FS16R-214414AS	15,76	4140	2080	5.704 €
	FS16R-214414BC	17,34	4140	2360	7.289 €	FS16R-214414BS	17,34	4140	2280	6.046 €
	FS16R-214414CC	18,91	4140	2560	7.618 €	FS16R-214414CS	18,91	4140	2480	6.377 €

100	Largo - Length (L)																				
	1180	1380	1580	1780	1980	2180	2380	2580	2780	2980	3180	3380	3580	3780	3980	4180	4380	4580	4780	4980	
Fondo - Depth mm 2180						FS6	FS7	FS8	FS9	FS10	FS11	FS12	FS13	FS14	FS15	FS16					

100	CON suelo - WITH floor panel					SIN suelo - WITHOUT floor panel				
	COD	m²	L	H	€	COD	m²	L	H	€
FS6	FS6C-218218AC	7,84	2180	2200	4.939 €	FS6C-218218AS	7,84	2180	2100	4.299 €
	FS6C-218218BC	8,62	2180	2400	5.186 €	FS6C-218218BS	8,62	2180	2300	4.544 €
	FS6C-218218CC	9,41	2180	2600	5.430 €	FS6C-218218CS	9,41	2180	2500	4.791 €
FS7	FS7C-218238AC	8,63	2380	2200	5.192 €	FS7C-218238AS	8,63	2380	2100	4.486 €
	FS7C-218238BC	9,50	2380	2400	5.451 €	FS7C-218238BS	9,5	2380	2300	4.738 €
	FS7C-218238CC	10,36	2380	2600	5.710 €	FS7C-218238CS	10,36	2380	2500	4.997 €
FS8	FS8C-218258AC	9,42	2580	2200	5.451 €	FS8C-218258AS	9,42	2580	2100	4.668 €
	FS8C-218258BC	10,37	2580	2400	5.716 €	FS8C-218258BS	10,37	2580	2300	4.939 €
	FS8C-218258CC	11,31	2580	2600	6.112 €	FS8C-218258CS	11,31	2580	2500	5.204 €
FS9	FS9C-218278AC	10,22	2780	2200	5.704 €	FS9C-218278AS	10,22	2780	2100	4.854 €
	FS9C-218278BC	11,24	2780	2400	6.112 €	FS9C-218278BS	11,24	2780	2300	5.134 €
	FS9C-218278CC	12,26	2780	2600	6.390 €	FS9C-218278CS	12,26	2780	2500	5.418 €
FS10	FS10C-218298AC	11,01	2980	2200	6.084 €	FS10C-218298AS	11,01	2980	2100	5.042 €
	FS10C-218298BC	12,11	2980	2400	6.377 €	FS10C-218298BS	12,11	2980	2300	5.336 €
	FS10C-218298CC	13,21	2980	2600	6.667 €	FS10C-218298CS	13,21	2980	2500	5.625 €
FS11	FS11C-218318AC	11,80	3180	2200	6.338 €	FS11C-218318AS	11,8	3180	2100	5.232 €
	FS11C-218318BC	12,98	3180	2400	6.643 €	FS11C-218318BS	12,98	3180	2300	5.535 €
	FS11C-218318CC	14,16	3180	2600	6.803 €	FS11C-218318CS	14,16	3180	2500	5.962 €
FS12	FS12C-218338AC	12,59	3380	2200	6.596 €	FS12C-218338AS	12,59	3380	2100	5.412 €
	FS12C-218338BC	13,85	3380	2400	6.909 €	FS12C-218338BS	13,85	3380	2300	5.729 €
	FS12C-218338CC	15,11	3380	2600	7.075 €	FS12C-218338CS	15,11	3380	2500	6.168 €
FS13	FS13C-218358AC	13,38	3580	2200	6.849 €	FS13C-218358AS	13,38	3580	2100	5.600 €
	FS13C-218358BC	14,72	3580	2400	7.029 €	FS13C-218358BS	14,72	3580	2300	6.053 €
	FS13C-218358CC	16,06	3580	2600	7.348 €	FS13C-218358CS	16,06	3580	2500	6.377 €
FS14	FS14C-218378AC	14,18	3780	2200	6.959 €	FS14C-218378AS	14,18	3780	2100	5.789 €
	FS14C-218378BC	15,59	3780	2400	7.289 €	FS14C-218378BS	15,59	3780	2300	6.247 €
	FS14C-218378CC	17,01	3780	2600	7.618 €	FS14C-218378CS	17,01	3780	2500	6.590 €
FS15	FS15C-218398AC	14,97	3980	2200	7.205 €	FS15C-218398AS	14,97	3980	2100	6.099 €
	FS15C-218398BC	16,47	3980	2400	7.548 €	FS15C-218398BS	16,47	3980	2300	6.448 €
	FS15C-218398CC	17,96	3980	2600	7.884 €	FS15C-218398CS	17,96	3980	2500	6.798 €
FS16	FS16C-218418AC	15,76	4180	2200	7.451 €	FS16C-218418AS	15,76	4180	2100	6.286 €
	FS16C-218418BC	17,34	4180	2400	7.808 €	FS16C-218418BS	17,34	4180	2300	6.649 €
	FS16C-218418CC	18,91	4180	2600	8.163 €	FS16C-218418CS	18,91	4180	2500	6.870 €





80	Largo - Length (L)																					
	1140	1340	1540	1740	1940	2140	2340	2540	2740	2940	3140	3340	3540	3740	3940	4140	4340	4540	4740	4940		
Fondo - Depth mm 2340							GS7	GS8	GS9	GS10	GS11	GS12	GS13	GS14	GS15	GS16	GS17					

80	CON suelo - WITH floor panel					SIN suelo - WITHOUT floor panel				
	COD	m²	L	H	€	COD	m²	L	H	€
GS7	GS7R-234234AC	9,5	2340	2160	5.062 €	GS7R-234234AS	9,5	2340	2080	4.304 €
	GS7R-234234BC	10,46	2340	2360	5.315 €	GS7R-234234BS	10,46	2340	2280	4.558 €
	GS7R-234234CC	11,41	2340	2560	5.567 €	GS7R-234234CS	11,41	2340	2480	4.809 €
GS8	GS8R-234254AC	10,38	2540	2160	5.315 €	GS8R-234254AS	10,38	2540	2080	4.486 €
	GS8R-234254BC	11,41	2540	2360	5.580 €	GS8R-234254BS	11,41	2540	2280	4.752 €
	GS8R-234254CC	12,45	2540	2560	5.846 €	GS8R-234254CS	12,45	2540	2480	5.017 €
GS9	GS9R-234274AC	11,25	2740	2160	5.567 €	GS9R-234274AS	11,25	2740	2080	4.668 €
	GS9R-234274BC	12,37	2740	2360	5.846 €	GS9R-234274BS	12,37	2740	2280	4.939 €
	GS9R-234274CC	13,5	2740	2560	6.117 €	GS9R-234274CS	13,5	2740	2480	5.217 €
GS10	GS10R-234294AC	12,12	2940	2160	5.818 €	GS10R-234294AS	12,12	2940	2080	4.849 €
	GS10R-234294BC	13,33	2940	2360	6.112 €	GS10R-234294BS	13,33	2940	2280	5.134 €
	GS10R-234294CC	14,54	2940	2560	6.396 €	GS10R-234294CS	14,54	2940	2480	5.424 €
GS11	GS11R-234314AC	12,99	3140	2160	6.077 €	GS11R-234314AS	12,99	3140	2080	5.031 €
	GS11R-234314BC	14,29	3140	2360	6.377 €	GS11R-234314BS	14,29	3140	2280	5.327 €
	GS11R-234314CC	15,59	3140	2560	6.655 €	GS11R-234314CS	15,59	3140	2480	5.625 €
GS12	GS12R-234334AC	13,86	3340	2160	6.330 €	GS12R-234334AS	13,86	3340	2080	5.212 €
	GS12R-234334BC	15,25	3340	2360	6.622 €	GS12R-234334BS	15,25	3340	2280	5.515 €
	GS12R-234334CC	16,64	3340	2560	6.920 €	GS12R-234334CS	16,64	3340	2480	5.826 €
GS13	GS13R-234354AC	14,74	3540	2160	6.565 €	GS13R-234354AS	14,74	3540	2080	5.392 €
	GS13R-234354BC	16,21	3540	2360	6.881 €	GS13R-234354BS	16,21	3540	2280	5.710 €
	GS13R-234354CC	17,68	3540	2560	7.192 €	GS13R-234354CS	17,68	3540	2480	6.032 €
GS14	GS14R-234374AC	15,61	3740	2160	6.816 €	GS14R-234374AS	15,61	3740	2080	5.573 €
	GS14R-234374BC	17,17	3740	2360	7.141 €	GS14R-234374BS	17,17	3740	2280	5.904 €
	GS14R-234374CC	18,73	3740	2560	7.457 €	GS14R-234374CS	18,73	3740	2480	6.234 €
GS15	GS15R-234394AC	16,48	3940	2160	7.063 €	GS15R-234394AS	16,48	3940	2080	5.755 €
	GS15R-234394BC	18,13	3940	2360	7.393 €	GS15R-234394BS	18,13	3940	2280	6.099 €
	GS15R-234394CC	19,78	3940	2560	7.730 €	GS15R-234394CS	19,78	3940	2480	6.427 €
GS16	GS16R-234414AC	17,35	4140	2160	7.309 €	GS16R-234414AS	17,35	4140	2080	5.936 €
	GS16R-234414BC	19,09	4140	2360	7.653 €	GS16R-234414BS	19,09	4140	2280	6.286 €
	GS16R-234414CC	20,82	4140	2560	8.001 €	GS16R-234414CS	20,82	4140	2480	6.622 €
GS17	GS17R-234434AC	18,22	4340	2160	7.555 €	GS17R-234434AS	18,22	4340	2080	6.117 €
	GS17R-234434BC	20,05	4340	2360	7.912 €	GS17R-234434BS	20,05	4340	2280	6.481 €
	GS17R-234434CC	21,87	4340	2560	8.266 €	GS17R-234434CS	21,87	4340	2480	6.830 €

100	Largo - Length (L)																					
	1180	1380	1580	1780	1980	2180	2380	2580	2780	2980	3180	3380	3580	3780	3980	4180	4380	4580	4780	4980		
Fondo - Depth mm 2380							GS7	GS8	GS9	GS10	GS11	GS12	GS13	GS14	GS15	GS16	GS17					

100	CON suelo - WITH floor panel					SIN suelo - WITHOUT floor panel				
	COD	m²	L	H	€	COD	m²	L	H	€
GS7	GS7C-238238AC	9,5	2380	2200	5.464 €	GS7C-238238AS	9,5	2380	2100	4.673 €
	GS7C-238238BC	10,46	2380	2400	5.729 €	GS7C-238238BS	10,46	2380	2300	4.947 €
	GS7C-238238CC	11,41	2380	2600	6.123 €	GS7C-238238CS	11,41	2380	2500	5.212 €
GS8	GS8C-238258AC	10,38	2580	2200	5.729 €	GS8C-238258AS	10,38	2580	2100	4.868 €
	GS8C-238258BC	11,41	2580	2400	6.139 €	GS8C-238258BS	11,41	2580	2300	5.146 €
	GS8C-238258CC	12,45	2580	2600	6.414 €	GS8C-238258CS	12,45	2580	2500	5.430 €
GS9	GS9C-238278AC	11,25	2780	2200	6.123 €	GS9C-238278AS	11,25	2780	2100	5.062 €
	GS9C-238278BC	12,37	2780	2400	6.414 €	GS9C-238278BS	12,37	2780	2300	5.354 €
	GS9C-238278CC	13,5	2780	2600	6.706 €	GS9C-238278CS	13,5	2780	2500	5.646 €
GS10	GS10C-238298AC	12,12	2980	2200	6.390 €	GS10C-238298AS	12,12	2980	2100	5.249 €
	GS10C-238298BC	13,33	2980	2400	6.694 €	GS10C-238298BS	13,33	2980	2300	5.554 €
	GS10C-238298CC	14,54	2980	2600	6.855 €	GS10C-238298CS	14,54	2980	2500	5.982 €
GS11	GS11C-238318AC	12,99	3180	2200	6.661 €	GS11C-238318AS	12,99	3180	2100	5.445 €
	GS11C-238318BC	14,29	3180	2400	6.830 €	GS11C-238318BS	14,29	3180	2300	5.761 €
	GS11C-238318CC	15,59	3180	2600	7.141 €	GS11C-238318CS	15,59	3180	2500	6.196 €
GS12	GS12C-238338AC	13,86	3380	2200	6.926 €	GS12C-238338AS	13,86	3380	2100	5.638 €
	GS12C-238338BC	15,25	3380	2400	7.102 €	GS12C-238338BS	15,25	3380	2300	6.084 €
	GS12C-238338CC	16,64	3380	2600	7.425 €	GS12C-238338CS	16,64	3380	2500	6.414 €
GS13	GS13C-238358AC	14,74	3580	2200	7.043 €	GS13C-238358AS	14,74	3580	2100	5.956 €
	GS13C-238358BC	16,21	3580	2400	7.373 €	GS13C-238358BS	16,21	3580	2300	6.292 €
	GS13C-238358CC	17,68	3580	2600	7.703 €	GS13C-238358CS	17,68	3580	2500	6.628 €
GS14	GS14C-208378AC	15,61	3780	2200	7.309 €	GS14C-208378AS	15,61	3780	2100	6.144 €
	GS14C-208378BC	17,17	3780	2400	7.653 €	GS14C-208378BS	17,17	3780	2300	6.493 €
	GS14C-208378CC	18,73	3780	2600	7.988 €	GS14C-208378CS	18,73	3780	2500	6.706 €
GS15	GS15C-238398AC	16,48	3980	2200	7.569 €	GS15C-238398AS	16,48	3980	2100	6.338 €
	GS15C-238398BC	18,13	3980	2400	7.923 €	GS15C-238398BS	18,13	3980	2300	6.700 €
	GS15C-238398CC	19,78	3980	2600	8.273 €	GS15C-238398CS	19,78	3980	2500	6.914 €
GS16	GS16C-238418AC	17,35	4180	2200	7.825 €	GS16C-238418AS	17,35	4180	2100	6.532 €
	GS16C-238418BC	19,09	4180	2400	8.194 €	GS16C-238418BS	19,09	4180	2300	6.765 €
	GS16C-238418CC	20,82	4180	2600	8.558 €	GS16C-238418CS	20,82	4180	2500	7.127 €
GS17	GS17C-238438AC	18,22	4380	2200	8.091 €	GS17C-238438AS	18,22	4380	2100	6.719 €
	GS17C-238438BC	20,05	4380	2400	8.468 €	GS17C-238438BS	20,05	4380	2300	6.959 €
	GS17C-238438CC	21,87	4380	2600	8.842 €	GS17C-238438CS	21,87	4380	2500	7.334 €





80	Largo - Length (L)																				
	1140	1340	1540	1740	1940	2140	2340	2540	2740	2940	3140	3340	3540	3740	3940	4140	4340	4540	4740	4940	
Fondo - Depth mm 2540								HS8	HS9	HS10	HS11	HS12	HS13	HS14	HS15	HS16	HS17	HS18			

80	CON suelo - WITH floor panel					SIN suelo - WITHOUT floor panel				
	COD	m²	L	H	€	COD	m²	L	H	€
HS8	HS8R-254254AC	11,33	2540	2160	5.580 €	HS8R-254254AS	11,33	2540	2080	4.673 €
	HS8R-254254BC	12,46	2540	2360	5.858 €	HS8R-254254BS	12,46	2540	2280	4.947 €
	HS8R-254254CC	13,59	2540	2560	6.131 €	HS8R-254254CS	13,59	2540	2480	5.224 €
HS9	HS9R-254274AC	12,28	2740	2160	5.846 €	HS9R-254274AS	12,28	2740	2080	4.861 €
	HS9R-254274BC	13,51	2740	2360	6.131 €	HS9R-254274BS	13,51	2740	2280	5.146 €
	HS9R-254274CC	14,74	2740	2560	6.409 €	HS9R-254274CS	14,74	2740	2480	5.430 €
HS10	HS10R-254294AC	13,23	2940	2160	6.112 €	HS10R-254294AS	13,23	2940	2080	5.042 €
	HS10R-254294BC	14,56	2940	2360	6.409 €	HS10R-254294BS	14,56	2940	2280	5.341 €
	HS10R-254294CC	15,88	2940	2560	6.687 €	HS10R-254294CS	15,88	2940	2480	5.638 €
HS11	HS11R-254314AC	14,18	3140	2160	6.377 €	HS11R-254314AS	14,18	3140	2080	5.107 €
	HS11R-254314BC	15,6	3140	2360	6.667 €	HS11R-254314BS	15,6	3140	2280	5.542 €
	HS11R-254314CC	17,02	3140	2560	6.972 €	HS11R-254314CS	17,02	3140	2480	5.852 €
HS12	HS12R-254334AC	15,14	3340	2160	6.628 €	HS12R-254334AS	15,14	3340	2080	5.418 €
	HS12R-254334BC	16,65	3340	2360	6.939 €	HS12R-254334BS	16,65	3340	2280	5.735 €
	HS12R-254334CC	18,16	3340	2560	7.250 €	HS12R-254334CS	18,16	3340	2480	6.060 €
HS13	HS13R-254354AC	16,09	3540	2160	6.887 €	HS13R-254354AS	16,09	3540	2080	5.606 €
	HS13R-254354BC	17,7	3540	2360	7.212 €	HS13R-254354BS	17,7	3540	2280	5.936 €
	HS13R-254354CC	19,31	3540	2560	7.534 €	HS13R-254354CS	19,31	3540	2480	6.266 €
HS14	HS14R-254374AC	17,04	3740	2160	7.147 €	HS14R-254374AS	17,04	3740	2080	5.794 €
	HS14R-254374BC	18,74	3740	2360	7.484 €	HS14R-254374BS	18,74	3740	2280	6.131 €
	HS14R-254374CC	20,45	3740	2560	7.814 €	HS14R-254374CS	20,45	3740	2480	6.466 €
HS15	HS15R-254394AC	17,99	3940	2160	7.406 €	HS15R-254394AS	17,99	3940	2080	5.982 €
	HS15R-254394BC	19,79	3940	2360	7.748 €	HS15R-254394BS	19,79	3940	2280	6.325 €
	HS15R-254394CC	21,59	3940	2560	8.091 €	HS15R-254394CS	21,59	3940	2480	6.667 €
HS16	HS16R-254414AC	18,94	4140	2160	7.664 €	HS16R-254414AS	18,94	4140	2080	6.161 €
	HS16R-254414BC	20,84	4140	2360	8.020 €	HS16R-254414BS	20,84	4140	2280	6.520 €
	HS16R-254414CC	22,73	4140	2560	8.377 €	HS16R-254414CS	22,73	4140	2480	6.875 €
HS17	HS17R-254434AC	19,9	4340	2160	7.923 €	HS17R-254434AS	19,9	4340	2080	6.343 €
	HS17R-254434BC	21,89	4340	2360	8.292 €	HS17R-254434BS	21,89	4340	2280	6.706 €
	HS17R-254434CC	23,88	4340	2560	8.655 €	HS17R-254434CS	23,88	4340	2480	7.075 €
HS18	HS18R-254454AC	20,85	4540	2160	8.182 €	HS18R-254454AS	20,85	4540	2080	6.525 €
	HS18R-254454BC	22,93	4540	2360	8.566 €	HS18R-254454BS	22,93	4540	2280	6.900 €
	HS18R-254454CC	25,02	4540	2560	8.939 €	HS18R-254454CS	25,02	4540	2480	7.282 €

100	Largo - Length (L)																				
	1180	1380	1580	1780	1980	2180	2380	2580	2780	2980	3180	3380	3580	3780	3980	4180	4380	4580	4780	4980	
Fondo - Depth mm 2580								HS8	HS9	HS10	HS11	HS12	HS13	HS14	HS15	HS16	HS17	HS18			

100	CON suelo - WITH floor panel					SIN suelo - WITHOUT floor panel				
	COD	m²	L	H	€	COD	m²	L	H	€
HS8	HS8C-258258AC	11,33	2580	2200	6.139 €	HS8C-258258AS	11,33	2580	2100	5.062 €
	HS8C-258258BC	12,46	2580	2400	6.427 €	HS8C-258258BS	12,46	2580	2300	5.354 €
	HS8C-258258CC	13,59	2580	2600	6.719 €	HS8C-258258CS	13,59	2580	2500	5.651 €
HS9	HS9C-258278AC	12,28	2780	2200	6.414 €	HS9C-258278AS	12,28	2780	2100	5.262 €
	HS9C-258278BC	13,51	2780	2400	6.719 €	HS9C-258278BS	13,51	2780	2300	5.561 €
	HS9C-258278CC	14,74	2780	2600	6.881 €	HS9C-258278CS	14,74	2780	2500	5.994 €
HS10	HS10C-258298AC	13,23	2980	2200	6.700 €	HS10C-258298AS	13,23	2980	2100	5.457 €
	HS10C-258298BC	14,56	2980	2400	6.870 €	HS10C-258298BS	14,56	2980	2300	5.774 €
	HS10C-258298CC	15,88	2980	2600	7.173 €	HS10C-258298CS	15,88	2980	2500	6.214 €
HS11	HS11C-258318AC	14,18	3180	2200	6.835 €	HS11C-258318AS	14,18	3180	2100	5.657 €
	HS11C-258318BC	15,60	3180	2400	7.154 €	HS11C-258318BS	15,6	3180	2300	6.112 €
	HS11C-258318CC	17,02	3180	2600	7.471 €	HS11C-258318CS	17,02	3180	2500	6.434 €
HS12	HS12C-258338AC	15,14	3380	2200	7.108 €	HS12C-258338AS	15,14	3380	2100	5.982 €
	HS12C-258338BC	16,65	3380	2400	7.436 €	HS12C-258338BS	16,65	3380	2300	6.318 €
	HS12C-258338CC	18,16	3380	2600	7.768 €	HS12C-258338CS	18,16	3380	2500	6.655 €
HS13	HS13C-258358AC	16,09	3580	2200	7.387 €	HS13C-258358AS	16,09	3580	2100	6.182 €
	HS13C-258358BC	17,70	3580	2400	7.722 €	HS13C-258358BS	17,7	3580	2300	6.532 €
	HS13C-258358CC	19,31	3580	2600	8.066 €	HS13C-258358CS	19,31	3580	2500	6.740 €
HS14	HS14C-258378AC	17,04	3780	2200	7.658 €	HS14C-258378AS	17,04	3780	2100	6.377 €
	HS14C-258378BC	18,74	3780	2400	8.007 €	HS14C-258378BS	18,74	3780	2300	6.740 €
	HS14C-258378CC	20,45	3780	2600	8.363 €	HS14C-258378CS	20,45	3780	2500	6.959 €
HS15	HS15C-258398AC	17,99	3980	2200	7.929 €	HS15C-258398AS	17,99	3980	2100	6.576 €
	HS15C-258398BC	19,79	3980	2400	8.292 €	HS15C-258398BS	19,79	3980	2300	6.810 €
	HS15C-258398CC	21,59	3980	2600	8.661 €	HS15C-258398CS	21,59	3980	2500	6.777 €
HS16	HS16C-258418AC	18,94	4180	2200	8.208 €	HS16C-258418AS	18,94	4180	2100	6.771 €
	HS16C-258418BC	20,84	4180	2400	8.584 €	HS16C-258418BS	20,84	4180	2300	7.011 €
	HS16C-258418CC	22,73	4180	2600	8.954 €	HS16C-258418CS	22,73	4180	2500	7.387 €
HS17	HS17C-258438AC	19,90	4380	2200	8.479 €	HS17C-258438AS	19,9	4380	2100	6.830 €
	HS17C-258438BC	21,89	4380	2400	8.868 €	HS17C-258438BS	21,89	4380	2300	7.219 €
	HS17C-258438CC	23,88	4380	2600	9.249 €	HS17C-258438CS	23,88	4380	2500	7.607 €
HS18	HS18C-258458AC	20,85	4580	2200	8.752 €	HS18C-258458AS	20,85	4580	2100	7.024 €
	HS18C-258458BC	22,93	4580	2400	9.155 €	HS18C-258458BS	22,93	4580	2300	7.425 €
	HS18C-258458CC	25,02	4580	2600	9.549 €	HS18C-258458CS	25,02	4580	2500	7.819 €





80	Largo - Length (L)																		
	1140	1340	1540	1740	1940	2140	2340	2540	2740	2940	3140	3340	3540	3740	3940	4140	4340	4540	4740
Fondo - Depth mm 2740																			

80	CON suelo - WITH floor panel					SIN suelo - WITHOUT floor panel				
	COD	m²	L	H	€	COD	m²	L	H	€
JS9	JS9R-274274AC	13,31	2740	2160	6.123 €	JS9R-274274AS	13,31	2740	2080	5.049 €
	JS9R-274274BC	14,64	2740	2360	6.421 €	JS9R-274274BS	14,64	2740	2280	5.346 €
	JS9R-274274CC	15,98	2740	2560	6.700 €	JS9R-274274CS	15,98	2740	2480	5.646 €
JS10	JS10R-274294AC	14,34	2940	2160	6.404 €	JS10R-274294AS	14,34	2940	2080	5.243 €
	JS10R-274294BC	15,78	2940	2360	6.694 €	JS10R-274294BS	15,78	2940	2280	5.554 €
	JS10R-274294CC	17,21	2940	2560	6.999 €	JS10R-274294CS	17,21	2940	2480	5.858 €
JS11	JS11R-274314AC	15,38	3140	2160	6.661 €	JS11R-274314AS	15,38	3140	2080	5.439 €
	JS11R-274314BC	16,91	3140	2360	6.977 €	JS11R-274314BS	16,91	3140	2280	5.755 €
	JS11R-274314CC	18,45	3140	2560	7.289 €	JS11R-274314CS	18,45	3140	2480	6.077 €
JS12	JS12R-274334AC	16,41	3340	2160	6.932 €	JS12R-274334AS	16,41	3340	2080	5.625 €
	JS12R-274334BC	18,05	3340	2360	7.258 €	JS12R-274334BS	18,05	3340	2280	5.962 €
	JS12R-274334CC	19,69	3340	2560	7.579 €	JS12R-274334CS	19,69	3340	2480	6.292 €
JS13	JS13R-274354AC	17,44	3540	2160	7.205 €	JS13R-274354AS	17,44	3540	2080	5.818 €
	JS13R-274354BC	19,18	3540	2360	7.542 €	JS13R-274354BS	19,18	3540	2280	6.161 €
	JS13R-274354CC	20,93	3540	2560	7.872 €	JS13R-274354CS	20,93	3540	2480	6.493 €
JS14	JS14R-274374AC	18,47	3740	2160	7.476 €	JS14R-274374AS	18,47	3740	2080	6.014 €
	JS14R-274374BC	20,32	3740	2360	7.819 €	JS14R-274374BS	20,32	3740	2280	6.357 €
	JS14R-274374CC	22,17	3740	2560	8.169 €	JS14R-274374CS	22,17	3740	2480	6.700 €
JS15	JS15R-274394AC	19,5	3940	2160	7.748 €	JS15R-274394AS	19,5	3940	2080	6.201 €
	JS15R-274394BC	21,46	3940	2360	8.105 €	JS15R-274394BS	21,46	3940	2280	6.550 €
	JS15R-274394CC	23,41	3940	2560	8.462 €	JS15R-274394CS	23,41	3940	2480	6.909 €
JS16	JS16R-274414AC	20,54	4140	2160	8.020 €	JS16R-274414AS	20,54	4140	2080	6.390 €
	JS16R-274414BC	22,59	4140	2360	8.389 €	JS16R-274414BS	22,59	4140	2280	6.752 €
	JS16R-274414CC	24,64	4140	2560	8.752 €	JS16R-274414CS	24,64	4140	2480	7.120 €
JS17	JS17R-274434AC	21,57	4340	2160	8.292 €	JS17R-274434AS	21,57	4340	2080	6.571 €
	JS17R-274434BC	23,73	4340	2360	8.668 €	JS17R-274434BS	23,73	4340	2280	6.954 €
	JS17R-274434CC	25,88	4340	2560	9.048 €	JS17R-274434CS	25,88	4340	2480	7.327 €
JS18	JS18R-274454AC	22,6	4540	2160	8.566 €	JS18R-274454AS	22,6	4540	2080	6.765 €
	JS18R-274454BC	24,86	4540	2360	8.954 €	JS18R-274454BS	24,86	4540	2280	7.147 €
	JS18R-274454CC	27,12	4540	2560	9.342 €	JS18R-274454CS	27,12	4540	2480	7.534 €
JS19	JS19R-274474AC	23,63	4740	2160	8.836 €	JS19R-274474AS	23,63	4740	2080	6.946 €
	JS19R-274474BC	26	4740	2360	9.239 €	JS19R-274474BS	26	4740	2280	7.348 €
	JS19R-274474CC	28,36	4740	2560	9.504 €	JS19R-274474CS	28,36	4740	2480	7.748 €

100	Largo - Length (L)																		
	1180	1380	1580	1780	1980	2180	2380	2580	2780	2980	3180	3380	3580	3780	3980	4180	4380	4580	4780
Fondo - Depth mm 2780																			

100	CON suelo - WITH floor panel					SIN suelo - WITHOUT floor panel				
	COD	m²	L	H	€	COD	m²	L	H	€
JS9	JS9C-278278AC	13,31	2780	2200	6.714 €	JS9C-278278AS	13,31	2780	2100	5.464 €
	JS9C-278278BC	14,64	2780	2400	6.881 €	JS9C-278278BS	14,64	2780	2300	5.779 €
	JS9C-278278CC	15,98	2780	2600	7.185 €	JS9C-278278CS	15,98	2780	2500	6.222 €
JS10	JS10C-278298AC	14,34	2980	2200	6.860 €	JS10C-278298AS	14,34	2980	2100	5.671 €
	JS10C-278298BC	15,78	2980	2400	7.180 €	JS10C-278298BS	15,78	2980	2300	6.123 €
	JS10C-278298CC	17,21	2980	2600	7.496 €	JS10C-278298CS	17,21	2980	2500	6.448 €
JS11	JS11C-278318AC	15,38	3180	2200	7.147 €	JS11C-278318AS	15,38	3180	2100	6.001 €
	JS11C-278318BC	16,91	3180	2400	7.476 €	JS11C-278318BS	16,91	3180	2300	6.338 €
	JS11C-278318CC	18,45	3180	2600	7.808 €	JS11C-278318CS	18,45	3180	2500	6.674 €
JS12	JS12C-278338AC	16,41	3380	2200	7.431 €	JS12C-278338AS	16,41	3380	2100	6.201 €
	JS12C-278338BC	18,05	3380	2400	7.774 €	JS12C-278338BS	18,05	3380	2300	6.550 €
	JS12C-278338CC	19,69	3380	2600	8.119 €	JS12C-278338CS	19,69	3380	2500	6.765 €
JS13	JS13C-278358AC	17,44	3580	2200	7.716 €	JS13C-278358AS	17,44	3580	2100	6.409 €
	JS13C-278358BC	19,18	3580	2400	8.074 €	JS13C-278358BS	19,18	3580	2300	6.771 €
	JS13C-278358CC	20,93	3580	2600	8.429 €	JS13C-278358CS	20,93	3580	2500	6.984 €
JS14	JS14C-278378AC	18,47	3780	2200	8.007 €	JS14C-278378AS	18,47	3780	2100	6.610 €
	JS14C-278378BC	20,32	3780	2400	8.370 €	JS14C-278378BS	20,32	3780	2300	6.835 €
	JS14C-278378CC	22,17	3780	2600	8.733 €	JS14C-278378CS	22,17	3780	2500	7.205 €
JS15	JS15C-278398AC	19,5	3980	2200	8.292 €	JS15C-278398AS	19,5	3980	2100	6.816 €
	JS15C-278398BC	21,46	3980	2400	8.668 €	JS15C-278398BS	21,46	3980	2300	7.051 €
	JS15C-278398CC	23,41	3980	2600	9.043 €	JS15C-278398CS	23,41	3980	2500	7.431 €
JS16	JS16C-278418AC	20,54	4180	2200	8.584 €	JS16C-278418AS	20,54	4180	2100	6.875 €
	JS16C-278418BC	22,59	4180	2400	8.965 €	JS16C-278418BS	22,59	4180	2300	7.264 €
	JS16C-278418CC	24,64	4180	2600	9.354 €	JS16C-278418CS	24,64	4180	2500	7.653 €
JS17	JS17C-278438AC	21,57	4380	2200	8.868 €	JS17C-278438AS	21,57	4380	2100	7.075 €
	JS17C-278438BC	23,73	4380	2400	9.264 €	JS17C-278438BS	23,73	4380	2300	7.471 €
	JS17C-278438CC	25,88	4380	2600	9.664 €	JS17C-278438CS	25,88	4380	2500	7.872 €
JS18	JS18C-278458AC	22,6	4580	2200	9.155 €	JS18C-278458AS	22,6	4580	2100	7.276 €
	JS18C-278458BC	24,86	4580	2400	9.560 €	JS18C-278458BS	24,86	4580	2300	7.685 €
	JS18C-278458CC	27,12	4580	2600	9.969 €	JS18C-278458CS	27,12	4580	2500	8.091 €
JS19	JS19C-278478AC	23,63	4780	2200	9.437 €	JS19C-278478AS	23,63	4780	2100	7.471 €
	JS19C-278478BC	26	4780	2400	9.860 €	JS19C-278478BS	26	4780	2300	7.891 €
	JS19C-278478CC	28,36	4780	2600	10.145 €	JS19C-278478CS	28,36	4780	2500	8.312 €





80	Largo - Length (L)																			
	1140	1340	1540	1740	1940	2140	2340	2540	2740	2940	3140	3340	3540	3740	3940	4140	4340	4540	4740	4940
Fondo - Depth mm 2940										KS10	KS11	KS12	KS13	KS14	KS15	KS16	KS17	KS18	KS19	KS20

80	CON suelo - WITH floor panel					SIN suelo - WITHOUT floor panel				
	COD	m²	L	H	€	COD	m²	L	H	€
KS10	KS10R-294294AC	15,46	2940	2160	6.674 €	KS10R-294294AS	15,46	2940	2080	5.445 €
	KS10R-294294BC	17	2940	2360	6.984 €	KS10R-294294BS	17	2940	2280	5.761 €
	KS10R-294294CC	18,55	2940	2560	7.303 €	KS10R-294294CS	18,55	2940	2480	6.077 €
KS11	KS11R-294314AC	16,57	3140	2160	6.959 €	KS11R-294314AS	16,57	3140	2080	5.638 €
	KS11R-294314BC	18,23	3140	2360	7.282 €	KS11R-294314BS	18,23	3140	2280	5.969 €
	KS11R-294314CC	19,88	3140	2560	7.607 €	KS11R-294314CS	19,88	3140	2480	6.299 €
KS12	KS12R-294334AC	17,68	3340	2160	7.243 €	KS12R-294334AS	17,68	3340	2080	5.834 €
	KS12R-294334BC	19,45	3340	2360	7.579 €	KS12R-294334BS	19,45	3340	2280	6.176 €
	KS12R-294334CC	21,22	3340	2560	7.912 €	KS12R-294334CS	21,22	3340	2480	6.506 €
KS13	KS13R-294354AC	18,79	3540	2160	7.529 €	KS13R-294354AS	18,79	3540	2080	6.032 €
	KS13R-294354BC	20,67	3540	2360	7.872 €	KS13R-294354BS	20,67	3540	2280	6.377 €
	KS13R-294354CC	22,55	3540	2560	8.216 €	KS13R-294354CS	22,55	3540	2480	6.719 €
KS14	KS14R-294374AC	19,9	3740	2160	7.814 €	KS14R-294374AS	19,9	3740	2080	6.234 €
	KS14R-294374BC	21,9	3740	2360	8.169 €	KS14R-294374BS	21,9	3740	2280	6.583 €
	KS14R-294374CC	23,89	3740	2560	8.273 €	KS14R-294374CS	23,89	3740	2480	6.932 €
KS15	KS15R-294394AC	21,02	3940	2160	8.091 €	KS15R-294394AS	21,02	3940	2080	6.421 €
	KS15R-294394BC	23,12	3940	2360	8.462 €	KS15R-294394BS	23,12	3940	2280	6.783 €
	KS15R-294394CC	25,22	3940	2560	8.829 €	KS15R-294394CS	25,22	3940	2480	7.154 €
KS16	KS16R-294414AC	22,13	4140	2160	8.377 €	KS16R-294414AS	22,13	4140	2080	6.610 €
	KS16R-294414BC	24,34	4140	2360	8.752 €	KS16R-294414BS	24,34	4140	2280	6.992 €
	KS16R-294414CC	26,55	4140	2560	9.133 €	KS16R-294414CS	26,55	4140	2480	7.367 €
KS17	KS17R-294434AC	23,24	4340	2160	8.661 €	KS17R-294434AS	23,24	4340	2080	6.803 €
	KS17R-294434BC	25,56	4340	2360	9.048 €	KS17R-294434BS	25,56	4340	2280	7.192 €
	KS17R-294434CC	27,89	4340	2560	9.437 €	KS17R-294434CS	27,89	4340	2480	7.579 €
KS18	KS18R-294454AC	24,35	4540	2160	8.946 €	KS18R-294454AS	24,35	4540	2080	6.999 €
	KS18R-294454BC	26,79	4540	2360	9.347 €	KS18R-294454BS	26,79	4540	2280	7.393 €
	KS18R-294454CC	29,22	4540	2560	9.613 €	KS18R-294454CS	29,22	4540	2480	7.795 €
KS19	KS19R-294474AC	25,46	4740	2160	9.230 €	KS19R-294474AS	25,46	4740	2080	7.192 €
	KS19R-294474BC	28,01	4740	2360	9.510 €	KS19R-294474BS	28,01	4740	2280	7.601 €
	KS19R-294474CC	30,56	4740	2560	9.664 €	KS19R-294474CS	30,56	4740	2480	8.007 €
KS20	KS20R-294494AC	26,58	4940	2160	9.515 €	KS20R-294494AS	26,58	4940	2080	7.387 €
	KS20R-294494BC	29,23	4940	2360	9.801 €	KS20R-294494BS	29,23	4940	2280	7.800 €
	KS20R-294494CC	31,89	4940	2560	10.209 €	KS20R-294494CS	31,89	4940	2480	8.222 €

100	Largo - Length (L)																			
	1180	1380	1580	1780	1980	2180	2380	2580	2780	2980	3180	3380	3580	3780	3980	4180	4380	4580	4780	4980
Fondo - Depth mm 2980										KS10	KS11	KS12	KS13	KS14	KS15	KS16	KS17	KS18	KS19	KS20

100	CON suelo - WITH floor panel					SIN suelo - WITHOUT floor panel				
	COD	m²	L	H	€	COD	m²	L	H	€
KS10	KS10C-298298AC	15,46	2980	2200	7.159 €	KS10C-298298AS	15,46	2980	2100	6.008 €
	KS10C-298298BC	17	2980	2400	7.490 €	KS10C-298298BS	17	2980	2300	6.343 €
	KS10C-298298CC	18,55	2980	2600	7.819 €	KS10C-298298CS	18,55	2980	2500	6.679 €
KS11	KS11C-298318AC	16,57	3180	2200	7.457 €	KS11C-298318AS	16,57	3180	2100	6.214 €
	KS11C-298318BC	18,23	3180	2400	7.800 €	KS11C-298318BS	18,23	3180	2300	6.565 €
	KS11C-298318CC	19,88	3180	2600	8.144 €	KS11C-298318CS	19,88	3180	2500	6.771 €
KS12	KS12C-298338AC	17,68	3380	2200	7.756 €	KS12C-298338AS	17,68	3380	2100	6.421 €
	KS12C-298338BC	19,45	3380	2400	8.110 €	KS12C-298338BS	19,45	3380	2300	6.783 €
	KS12C-298338CC	21,22	3380	2600	8.462 €	KS12C-298338CS	21,22	3380	2500	7.004 €
KS13	KS13C-298358AC	18,79	3580	2200	8.060 €	KS13C-298358AS	18,79	3580	2100	6.635 €
	KS13C-298358BC	20,67	3580	2400	8.422 €	KS13C-298358BS	20,67	3580	2300	6.860 €
	KS13C-298358CC	22,55	3580	2600	8.783 €	KS13C-298358CS	22,55	3580	2500	7.230 €
KS14	KS14C-298378AC	19,9	3780	2200	8.357 €	KS14C-298378AS	19,9	3780	2100	6.706 €
	KS14C-298378BC	21,9	3780	2400	8.733 €	KS14C-298378BS	21,9	3780	2300	7.082 €
	KS14C-298378CC	23,89	3780	2600	9.109 €	KS14C-298378CS	23,89	3780	2500	7.457 €
KS15	KS15C-298398AC	21,02	3980	2200	8.655 €	KS15C-298398AS	21,02	3980	2100	6.909 €
	KS15C-298398BC	23,12	3980	2400	9.043 €	KS15C-298398BS	23,12	3980	2300	7.297 €
	KS15C-298398CC	25,22	3980	2600	9.431 €	KS15C-298398CS	25,22	3980	2500	7.685 €
KS16	KS16C-298418AC	22,13	4180	2200	8.960 €	KS16C-298418AS	22,13	4180	2100	7.114 €
	KS16C-298418BC	24,34	4180	2400	9.354 €	KS16C-298418BS	24,34	4180	2300	7.508 €
	KS16C-298418CC	26,55	4180	2600	9.748 €	KS16C-298418CS	26,55	4180	2500	7.912 €
KS17	KS17C-298438AC	23,24	4380	2200	9.259 €	KS17C-298438AS	23,24	4380	2100	7.321 €
	KS17C-298438BC	25,56	4380	2400	9.664 €	KS17C-298438BS	25,56	4380	2300	7.730 €
	KS17C-298438CC	27,89	4380	2600	10.073 €	KS17C-298438CS	27,89	4380	2500	8.137 €
KS18	KS18C-298458AC	24,35	4580	2200	9.555 €	KS18C-298458AS	24,35	4580	2100	7.276 €
	KS18C-298458BC	26,79	4580	2400	9.976 €	KS18C-298458BS	26,79	4580	2300	7.942 €
	KS18C-298458CC	29,22	4580	2600	10.253 €	KS18C-298458CS	29,22	4580	2500	8.363 €
KS19	KS19C-298478AC	25,46	4780	2200	9.852 €	KS19C-298478AS	25,46	4780	2100	7.730 €
	KS19C-298478BC	28,01	4780	2400	10.145 €	KS19C-298478BS	28,01	4780	2300	8.163 €
	KS19C-298478CC	30,56	4780	2600	10.694 €	KS19C-298478CS	30,56	4780	2500	8.590 €
KS20	KS20C-298498AC	26,58	4980	2200	10.158 €	KS20C-298498AS	26,58	4980	2100	7.929 €
	KS20C-298498BC	29,23	4980	2400	10.448 €	KS20C-298498BS	29,23	4980	2300	8.377 €
	KS20C-298498CC	31,89	4980	2600	11.012 €	KS20C-298498CS	31,89	4980	2500	8.818 €





CORTINAS DE LAMAS
PVC STRIP CURTAINS



CORECO



Las cortinas de lamas están formadas por láminas de PVC flexible y transparente solapadas entre si.

The PVC strip curtains strip are formed by flexible and transparent PVC sheets joined together.

Herrajes fabricados en acero inoxidable aptas el sector del frio industrial.

All fittings and screws are made in stainless Steel and suitable for the industrial refrigeration.

El uso de lamas de PVC flexible es muy útil en puertas frigoríficas para reducir el porcentaje de pérdidas de energía a la hora de cargar y descargar mercancías.

The use of flexible PVC strip are very useful for refrigerating doors. They reduced the lost of energy when you uoload and download the products

La fijación del soporte de lamas puede situarse tanto en el panel puerta como en el techo de la cámara.

The fixing of the PVC strip curtains support can be placed weather in the panel of the door or in the ceiling of the cold room.

Todas las lamas de PVC flexible, pueden ser utilizadas en salas donde se almacenan, preparan, elaboran, etc... los alimentos, incluidos los almacenes donde se cargan las mercancías.

All the PVC strip curtains, can be use in rooms where they can elaborate foods, as well as in warehouses where goods are loaded.

Con un sistema de montaje fácil y sencillo, permite la colocación y sustitución de las lamas de forma rápida y cómoda. Se suministrarán tornillos autorroscantes de acero inoxidable.

Whith an easy assembly system, it allows the place and replacement of the strip in an easily and comfortable way. It is supplied with stainless sets self-tapping screws.

PROPIEDADES PROPERTIES	NORMA TEST METHOD	UNIDAD UNIT	REFRIGERACIÓN CHILLER	CONGELACIÓN FREEZER
Dureza Shore "A" Hardnes	DIN53 505	-	75	65
Densidad específica Specific Density	DIN 53 479	g/cm3	1.22	1.2
Temperatura de servicio Temperature Resistance	-	°C	+50/-20	+35/-40
Flexibilidad Flexibility	-	°C	-35	-40
Temperatura de rotura al frío Cold Bend Brittle Point	DIN 53 372	°C	-35	-45
Elongación de rotura Elongation at Break	DIN 53 455	%	360	400
Resistencia a la rotura Tensile Strength	DIN 53 455	n/mm2	17	13
Absorción de agua Water Absorption	DIN 53 472	Mg	17	21
Transparencia Light Transmittance	ASTM D 1003	%	>80	>75
Protección acústica Sound Protection	DIN 52 210	dB	>35	>35
Inflamabilidad / Resistencia al Fuego Flammability/Reaction to Fire	DIN 53 382	-	Autoextinguibles Self extinguishing	

TODAS NUESTRAS LAMAS RESISTEN LOS RAYOS UV

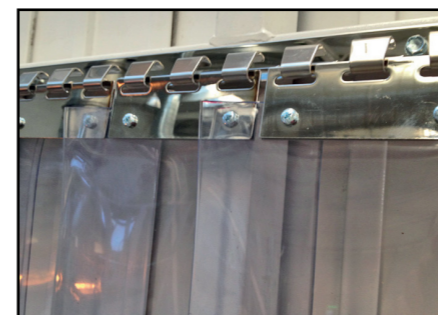
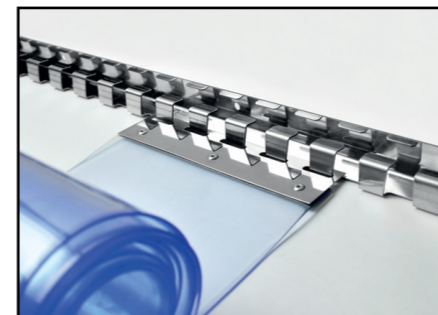
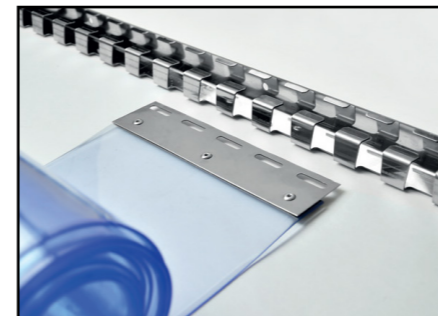

Dimensiones luz puerta
Door opening

	alto height mm	ancho width mm	€	
refrigeración - chiller	CLR060-185	1850	600	165 €
	CLR070-185	1850	700	191 €
	CLR080-185	1850	800	222 €
	CLR090-185	1850	900	248 €
	CLR0100-185	1850	1000	280 €
	CLR0120-185	1850	1200	331 €
	CLR0140-185	1850	1400	388 €
	CLR0160-185	1850	1600	446 €
	CLR0180-185	1850	1800	502 €
	CLR0200-185	1850	2000	555 €
	CLR060-200	2000	600	173 €
	CLR070-200	2000	700	203 €
	CLR080-200	2000	800	229 €
	CLR090-200	2000	900	261 €
	CLR0100-200	2000	1000	292 €
	CLR0120-200	2000	1200	351 €
	CLR0140-200	2000	1400	407 €
	CLR0160-200	2000	1600	464 €
	CLR0180-200	2000	1800	522 €
	CLR0200-200	2000	2000	579 €
congelados - freezer	CLC060-185	1850	600	209 €
	CLC070-185	1850	700	248 €
	CLC080-185	1850	800	280 €
	CLC090-185	1850	900	319 €
	CLC0100-185	1850	1000	351 €
	CLC0120-185	1850	1200	419 €
	CLC0140-185	1850	1400	497 €
	CLC0160-185	1850	1600	567 €
	CLC0180-185	1850	1800	636 €
	CLC0200-185	1850	2000	707 €
	CLC060-200	2000	600	222 €
	CLC070-200	2000	700	261 €
	CLC080-200	2000	800	300 €
	CLC090-200	2000	900	336 €
	CLC0100-200	2000	1000	369 €
	CLC0120-200	2000	1200	446 €
	CLC0140-200	2000	1400	522 €
	CLC0160-200	2000	1600	592 €
	CLC0180-200	2000	1800	669 €
	CLC0200-200	2000	2000	746 €

Fabricamos Cortinas de Lamas para cualquier dimensión de puerta.

We are the manufacturers of the strip curtains, and can supply curtains for any door sizes.

Consultar con nuestro departamento comercial.

Contact our sales team for a quote.

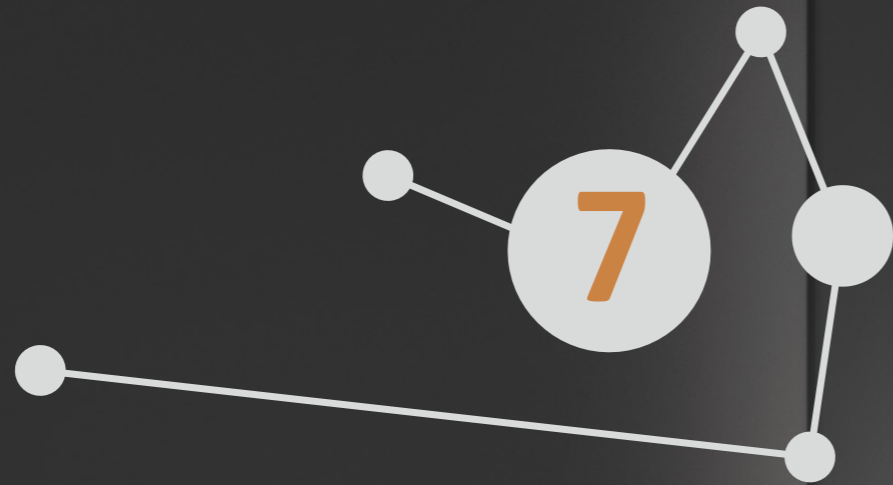

ESTANTERÍAS
SHELVING



CORECO



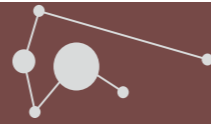

CORECO le presenta su nueva gama de ESTANTERÍAS MODULARES realizadas con una estructura de aluminio anodizado y parrillas de polietileno, aptas para el uso con productos alimentarios. Con nuestras Estanterías y sus múltiples combinaciones conseguiremos una óptima eficiencia en la organización y almacenaje de su cocina industrial. Además, los materiales empleados en su construcción, la hacen especialmente adecuadas para su uso en cámaras frigoríficas.

CORECO presents its new range of MODULAR SHELVING UNITS made with an anodized aluminium structure and polyethylene wire shelves, suitable for food storage. Our Shelving Units and their multiple combinations will enable you to efficiently store and organise your industrial kitchen. Additionally, the materials used to build the units make them especially durable for use in cold room.

Características técnicas:

- Especialmente diseñadas para uso alimentario.
- Estructura de aluminio anodizado que proporciona gran rigidez al conjunto.
- Parrillas fabricadas en polietileno calidad alimentaria.
- Tornillería utilizada en su construcción de acero inoxidable.
- Máxima modularidad que la hace adaptable a todos los espacios.
- Dos Fondos de estantes, 400 ó 500 mm.
- Tres alturas, con estantes regulables cada 150 mm.
- También recomendadas para el uso en cámaras frigoríficas, tanto para temperaturas positivas como negativas.
- No se necesita ningún tipo de herramientas para su montaje.

Technical specifications:

- Specifically designed for use with food products.
- Strong anodized aluminium structure.
- Wire shelves are made of food grade polyethylene.
- Assembled using stainless steel screws.
- Maximum modularity making the units adaptable to all spaces.
- Two shelf depths, 400 or 500mm.
- Three heights, with adjustable shelves every 150mm.
- Also recommended for use in cold rooms, for both plus and minus temperatures.
- No tools are needed for assembly.

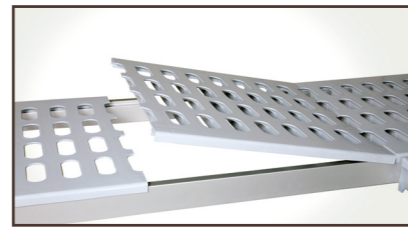
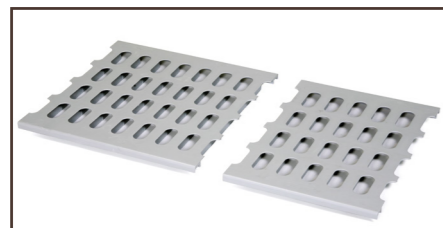

Parrillas: Fácil montaje y desmontaje. Máxima higiene. Las parrillas se pueden lavar en lavavajillas convencional.

Wire shelves: Easy assembly and disassembly. Maximum hygiene. Wire shelves can be washed in a conventional dishwasher.



Soportes ángulo: Posibilitan el montaje en ángulo de la estantería otorgándole gran modularidad.
Angle brackets: Make it possible to mount shelving units at an angle providing a high amount of flexibility.



Montaje: Fácil montaje. Todas las piezas encajan a la perfección sin necesidad de herramientas.
Assembly: Easy assembly. All pieces fit together perfectly without the need for tools.

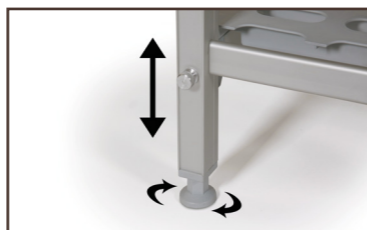

Pies: Con regulación en altura para salvar posibles desniveles del suelo.
Feet: Adjustable feet for uneven floors.

Características técnicas y constructivas sujetas a variación sin previo aviso.

We reserve the right to change specifications without prior notice.

MODULARIDAD TOTAL:

La gran modularidad de la estantería le permite combinar diferentes dimensiones y formas para así adaptarse al espacio disponible de su recinto. Personalice su estantería agregando, si lo requiere, mas niveles de estantes a los suministrados de manera estándar. La combinación de medidas y formas diferentes dan como resultado una óptima organización de su area de trabajo y/o almacenaje.

A partir de la estantería de que disponga, puede llegar a configurar tantas combinaciones como requiera.



COMPLETE FLEXIBILITY:

The enhanced flexibility of the shelving units allows you to combine different sizes and shapes to adapt to the space available in your room. If required, you can customise your product by adding extra shelves to the standard model. The combination of different shapes and sizes results in optimal organisation of your work area and/or storage.

From the shelving units available you can configure as many combinations as required.



CAPACIDAD Y RESISTENCIA:

En estantes de hasta 1 metro de longitud, puede almacenar hasta 120 Kgrs. de peso repartidos de forma uniforme. A partir de 1 metro de longitud la carga admisible repartida uniformemente pasa a ser de 100 Kgrs.

CAPACITY AND RESISTANCE:

Shelves up to one metre in length can store a maximum of 120kg of evenly distributed weight. Shelves over one metre in length can withstand a maximum of 100kg of evenly distributed weight.

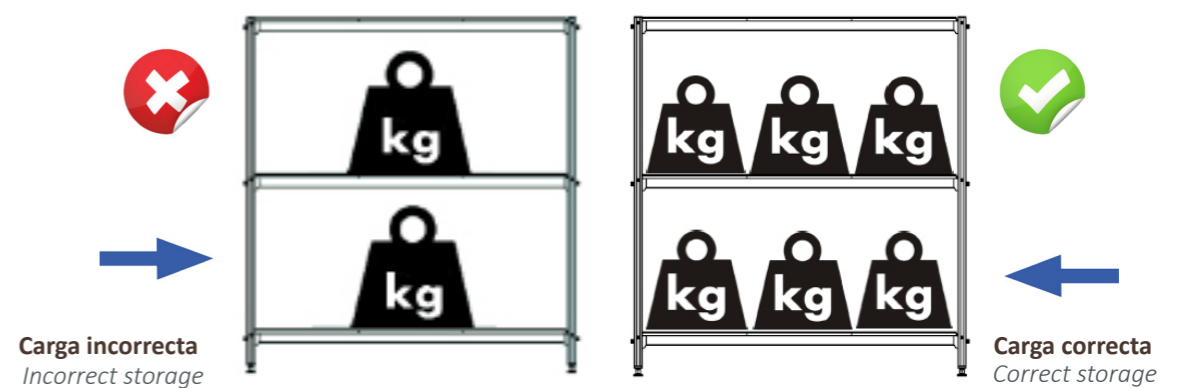

Características técnicas y constructivas sujetas a variación sin previo aviso.

We reserve the right to change specifications without prior notice.

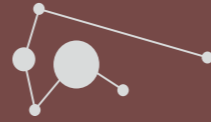

ESTANTERÍA LINEAL. (L)

La Estantería LINEAL es una estantería individual con escaleras soportes en cada extremo. Esta estantería permite, además de su montaje independiente, múltiples combinaciones mediante la colocación de estanterías complementarias y/o angulares por ambos lados.

LINEAR SHELVING UNITS. (L)

LINEAR Shelving Units are individual units supported by uprights at each end. This shelving unit allows, in addition to independent assembly, multiple shelving combinations by adding supplementary shelving units and/or angular shelving units on both sides.



ESTANTERÍA COMPLEMENTARIA. (C)

La Estantería COMPLEMENTARIA es una estantería individual con escaleras soportes en SÓLO uno de sus extremos, ya que el otro se une a la escalera de la estantería a la que complementa. La estantería complementaria puede complementar a una estantería Lineal, a otra Complementaria o a una Angular.

SUPPLEMENTARY SHELVING UNITS. (C)

SUPPLEMENTARY Shelving Units are individual units supported by uprights on ONLY one end as the other end connects to the additional shelving unit. Supplementary shelving can be added to Linear shelving units, other Supplementary shelving or to Angular shelving units.



ESTANTERÍA ANGULAR. (A)

La estantería ANGULAR es una estantería individual con escaleras soportes en SÓLO uno de sus extremos. La sujeción del extremo que no tiene escalera se realiza mediante unos soportes de acero inoxidable que facilitan su montaje en ángulo. Estos soportes van incluidos cuando se pide una estantería angular.

ANGULAR SHELVING UNITS. (A)

ANGULAR Shelving Units are individual units supported by uprights on ONLY one side. On the side without uprights, the stainless steel brackets which support the unit are assembled at an angle. These brackets are included when an angular shelving unit is ordered.

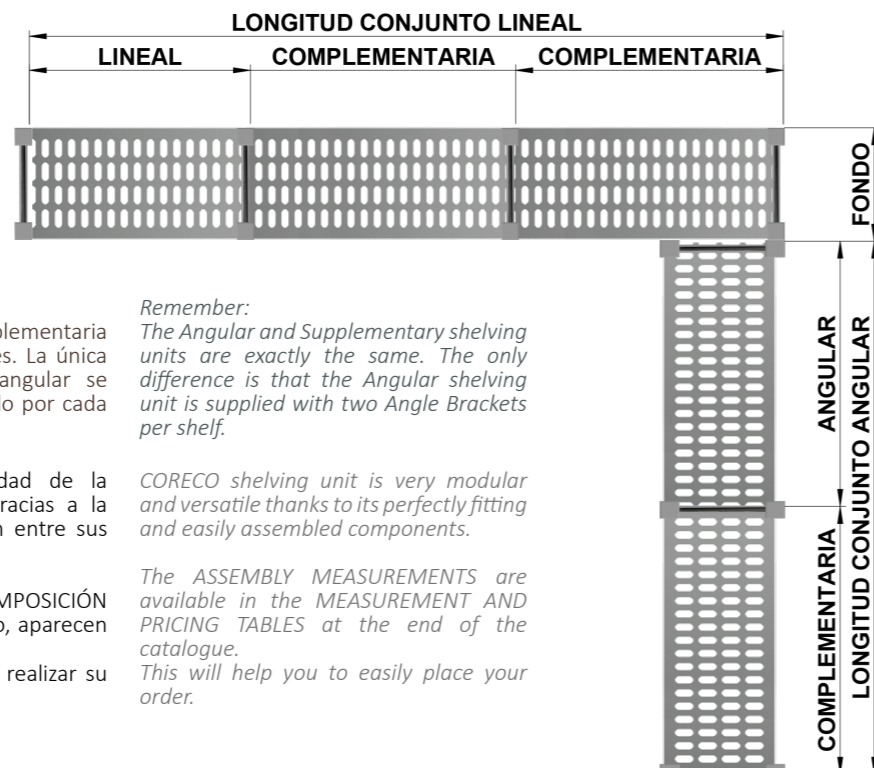
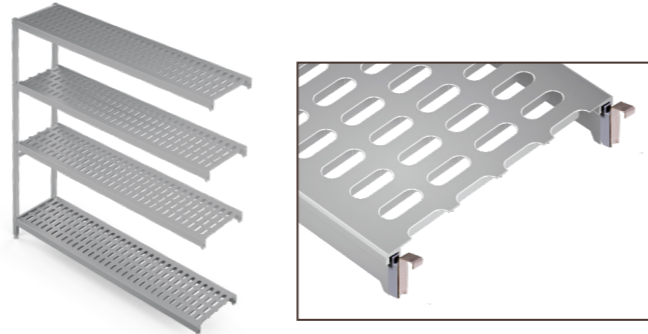

Recuerde: La estantería Angular y la Complementaria son estanterías exactamente iguales. La única diferencia es que la estantería angular se suministra con dos Soportes Ángulo por cada nivel.

Remember: The Angular and Supplementary shelving units are exactly the same. The only difference is that the Angular shelving unit is supplied with two Angle Brackets per shelf.

La gran modularidad y versatilidad de la Estantería CORECO se consigue gracias a la perfecta unión y fácil combinación entre sus elementos.

CORECO shelving unit is very modular and versatile thanks to its perfectly fitting and easily assembled components.

En las TABLAS DE VALORACIÓN Y COMPOSICIÓN DE CONJUNTOS, al final de catálogo, aparecen las LONGITUDES DE CONJUNTO. Esto le servirá de gran ayuda para realizar su pedido fácilmente.

The ASSEMBLY MEASUREMENTS are available in the MEASUREMENT AND PRICING TABLES at the end of the catalogue. This will help you to easily place your order.

Características técnicas y constructivas sujetas a variación sin previo aviso.

We reserve the right to change specifications without prior notice.

Recuerde:

Si se requieren mas niveles de estantes de los suministrados de manera estándar, sumar al valor de la estantería el valor del estante correspondiente que aparece en el apartado: COMPONENTES DE LA ESTANTERÍAS.

Remember:

If you need more shelves than the amount supplied with the standard product, add the price of the extra shelf or shelving unit to the corresponding price of the unit listed in this section SHELVING UNIT COMPONENTS.

ALTURA 1370 mm.
FONDO 400 Ó 500 mm.
3 ó 4 NIVELES

HEIGHT 1370mm
DEPTH 400 or 500mm
3 or 4 SHELVES

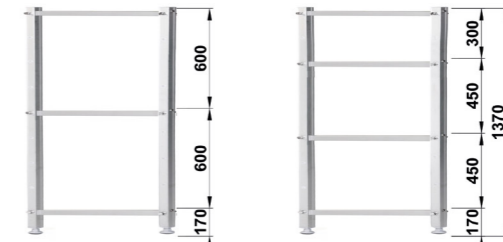

ALTURA 1670 mm.
FONDO 400 Ó 500 mm.
3 ó 4 NIVELES

HEIGHT 1670mm
DEPTH 400 or 500mm
3 or 4 SHELVES

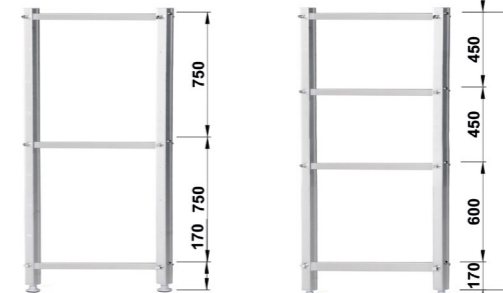

Separación mínima 150 mm
150 mm min. distance

ALTURA 1970 mm.
FONDO 400 Ó 500 mm.
3,4 ó 5 NIVELES

HEIGHT 1970mm
DEPTH 400 or 500mm
3, 4 or 5 SHELVES

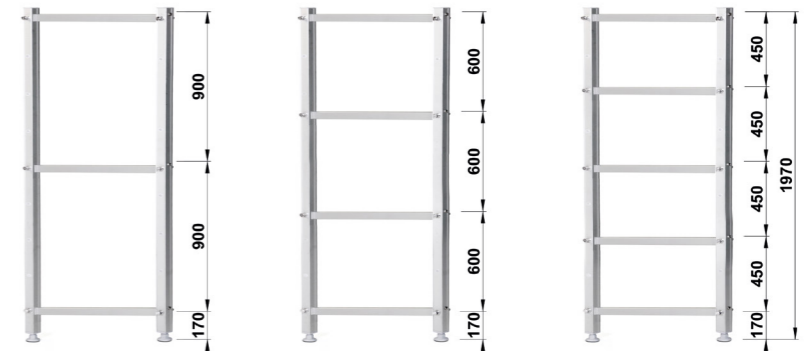

LONGITUD DE ESTANTERÍAS LINEALES INDIVIDUALES. COMPOSICIÓN DE ESTANTES.

LENGTH OF INDIVIDUAL LINEAR SHELVING UNITS. SHELF ASSEMBLY.

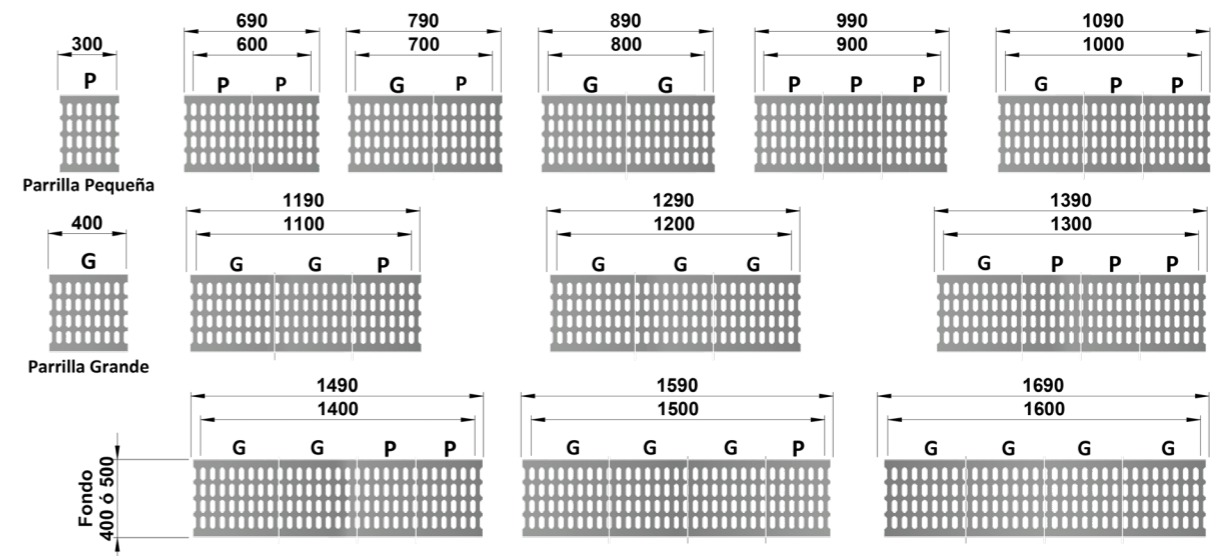

Características técnicas y constructivas sujetas a variación sin previo aviso.

We reserve the right to change specifications without prior notice.

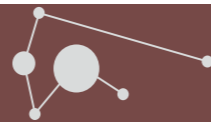

SOPORTES ESCALERAS:

Resistentes y fabricados en aluminio anodizado. De manera estándar se suministran en tres alturas diferentes y para dos fondos, 400 ó 500 mm. En función de su altura se pueden elegir con 3, 4 ó 5 niveles de estantes. Disponen de patas regulables y en todos los casos permiten la regulación de los estantes cada **150 mm**. Los Soportes Escaleras se sirven completos, con todos los elementos necesarios para montar los estantes.

SUPPORTING BRACKETS:

Hard-wearing anodised aluminium. The standard product includes three different heights and two depths of 400 or 500mm. Depending on their height, they can be ordered with 3, 4 or 5 individual shelves. They have adjustable feet which allow shelves to be adjusted every 150mm. Supporting uprights are provided with all the necessary components to assemble the shelves.

FONDO 400 / DEPTH 400

ALTURA HEIGHT	MODELO MODEL	NIVELES SHELVES	€
1370	E137F4-3N	3	76 €
1370	E137F4-4N	4	84 €
1670	E167F4-3N	3	83 €
1670	E167F4-4N	4	92 €
1970	E197F4-3N	3	101 €
1970	E197F4-4N	4	109 €
1970	E197F4-5N	5	117 €

FONDO 500 / DEPTH 500

ALTURA HEIGHT	MODELO MODEL	NIVELES SHELVES	€
1370	E137F5-3N	3	78 €
1370	E137F5-4N	4	85 €
1670	E167F5-3N	3	84 €
1670	E167F5-4N	4	94 €
1970	E197F5-3N	3	105 €
1970	E197F5-4N	4	113 €
1970	E197F5-5N	5	122 €

Recuerde:

Mas niveles de estantes bajo pedido. No olvide pedir los pasadores o soportes angulares necesarios.

Remember:

More shelves are available on request. Do not forget to ask for the necessary bolts or angular brackets.

KIT ESTANTES:

Los Estantes forman los distintos niveles de la estantería. Si necesita incorporar mas niveles a su estantería, nos puede solicitar estantes sueltos. En ese caso no olvide agregar a su pedido los pasadores y soportes ángulo necesarios.

FONDO 400 / DEPTH 400

LONGITUD LENGTH	MODELO MODEL	€
600	ES600F4	37 €
700	ES700F4	42 €
800	ES800F4	46 €
900	ES900F4	53 €
1000	ES1000F4	58 €
1100	ES1100F4	61 €
1200	ES1200F4	63 €
1300	ES1300F4	66 €
1400	ES1400F4	74 €
1500	ES1500F4	76 €
1600	ES1600F4	78 €

FONDO 500 / DEPTH 500

LONGITUD LENGTH	MODELO MODEL	€
600	ES600F5	42 €
700	ES700F5	48 €
800	ES800F5	53 €
900	ES900F5	59 €
1000	ES1000F5	64 €
1100	ES1100F5	68 €
1200	ES1200F5	73 €
1300	ES1300F5	74 €
1400	ES1400F5	81 €
1500	ES1500F5	84 €
1600	ES1600F5	85 €

PASADORES:

Juego de pasadores (macho + hembra). Fabricados en aluminio, van incorporados a la escalera en función al numero de niveles que solicite en su pedido. Son elementos necesarios para poder ampliar el número de estantes de su estantería.

BOLTS:

Set of bolts (male + female). The supporting uprights are put together with aluminium bolts, according to the number of shelves ordered. They are necessary to be able to increase the number of shelves in your shelving unit.

MODELO MODEL	€/ UD. € per U	DOTACIÓN NECESARIA POR ESTANTE EQUIPMENT NEEDED FOR SHELVES
PA	5 €	4 uds. por estante en estantería LINEAL y/o COMPLEMENTARIA 4 units per shelf in the LINEAR and/or SUPPLEMENTARY shelving units
		2 uds. por estante en estantería ANGULAR 2 units per shelf in the ANGULAR shelving



SOPORTES ÁNGULO:

Posibilitan el montaje de la estantería en un ángulo de 90º, dotando a la estantería de una gran modularidad.

ANGLE BRACKETS:

These allow the shelving units to be mounted at a 90° angle, making the unit very flexible.

MODELO MODEL	€/ UD. € per U	DOTACIÓN NECESARIA POR ESTANTE EQUIPMENT NEEDED FOR SHELVES
SA	9 €	2 uds. por estante en estantería ANGULAR 2 units per shelf in the ANGULAR shelving



1370 1670 1970

SHELVES KIT:

Shelves form the different levels of the shelving units. If you need to add more shelves to your shelving unit, you can request individual shelves. In that case, don't forget to add the necessary bolts and angle brackets to your order.



De serie:

- 1 estante base fijo de carga fijo.
- 4 estantes de carga móviles 600x665 regulables en altura (paso 80mm), inclinación (0°, 8° y 16°) y profundidad.
- Barandilla frontal de alambre plastificado blanco.
- Portaprecios.

Opción:

- Separador lateral blanco o cromado
- Barandilla frontal cromada o metacrilato



ME2P600

módulo estantería shelves module	mod.	fondo depth mm	puertas doors uds	€
ME1P600		600	1	1.110 €
ME2P600		600	2	2.119 €
ME3P600		600	3	3.108 €
ME4P600		600	4	4.189 €
ME5P600		600	5	5.233 €

Standar:

- 1 loading level fixed
- 4 moving shelves of loading 600x665 adjustable on height(space 80mm), inclination(0°, 8° y 16°) and depth.
- Front railing in white coating wire
- Price tag

Optional:

- White or Chromed Side separator
- Chromed or Methacrylate front railing

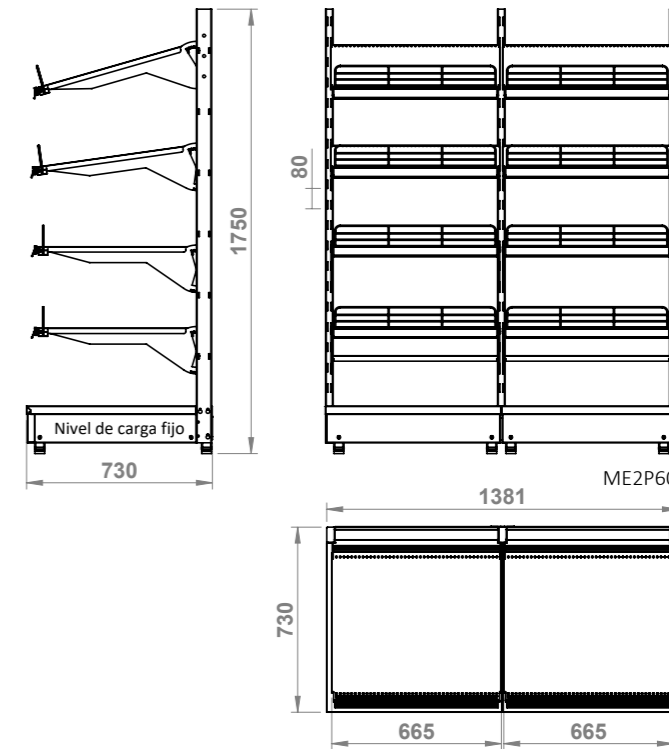

AFD-PC



RFM-PC

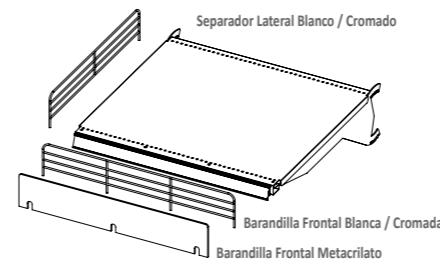

	Opcinal Optional	€
separador lateral cromado	chromed lateral divider	35 €
barandilla frontal metacrilato	plexy front railing	35 €
barandilla frontal cromada	chromed front railing	35 €



- Separación lateral, cada 1 cm.
- Lateral separation, every 1 cm.

Características técnicas y constructivas sujetas a variación sin previo aviso.

We reserve the right to change specifications without prior notice.

Características técnicas y constructivas sujetas a variación sin previo aviso.

We reserve the right to change specifications without prior notice.

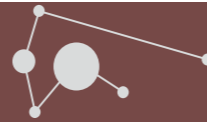

Para su comodidad en las **Tablas de Valoración y Composición de Conjuntos**, al final de este apartado, tiene ya calculados los conjuntos para cada longitud.

Usted solo ha de elegir el fondo de estante deseado, la altura de la estantería y el número de niveles de estantes.

Una vez elegido tome nota del Código de Artículo y háganos llegar su pedido.

For your convenience the length of each unit has been calculated in the Measurement and Pricing tables at the end of this catalogue. You only have to choose the shelf depth, the shelving unit height and the numbers of shelves you want. Once you have chosen, note down the product code and send us your order.

Ejemplo para colocar estanterías en forma de 'L' en un recinto de dimensiones 4000 x 3000 mm.

Para el ejemplo tomamos como base una estantería de altura 1670 mm, fondo 400 mm y 4 niveles de estantes.

1. Para la pared de 4000 mm de nuestro recinto consultaremos en la Tabla de Valoración y Composición de Conjuntos la estantería lineal de longitud inmediatamente inferior a los 4000 mm. Buscando en la tabla **Estantería lineal de fondo 400 mm. altura 1670 mm y 4 niveles** encontramos una estantería con longitud 3960 mm. (Cód. de artículo L214).

2. En la siguiente pared de 3000 mm. queremos colocar otra estantería. En este caso elegiremos una estantería angular. La longitud de la misma será 3000 mm. que es la dimensión de la pared menos el fondo de la estantería que hemos colocado anteriormente. En nuestro ejemplo es 400 mm. Buscaremos en la tabla **Estantería angular de fondo 400 mm. y altura 1670 mm y 4 niveles** y encontraremos una estantería de longitud 2580 mm. (Cód. de artículo A201).

Si quisieramos colocar otra estantería en la segunda pared de 4000 mm. solo tendríamos que repetir el paso 2.

Example of how to build an L shaped shelving unit in a 4000x3000mm room.

For this we would choose a shelving unit measuring 1670mm height, a 400mm depth and 4 shelves.

1. For a wall measuring 4000 mm, we would consult the Measurement and Pricing tables for a shelving unit measuring less than 4000mm in length.

Searching in the table for a Linear Shelving Unit with a depth of 400mm, a height of 1670 mm and 4 shelves, we find a shelving unit measuring 3960mm in length. (Product code L214).

2. On the other wall measuring 3000mm, we want to assemble another shelving unit.

In this case we choose an angular shelving unit. The length of the unit will measure 3000mm, equalling the length of the wall, minus the depth of the other shelving unit we have already assembled. In our example it measures 400mm.

Searching in the table for an Angular Shelving Unit with a depth of 400mm, a height of 1670 mm and 4 shelves, we find a shelving unit measuring 2580mm in length. (Product code A201).

If we wanted to put another shelving unit on the second wall measuring 4000mm, we would just repeat step 2.

Recuerde:

Para elegir su estantería LINEAL vaya a las tablas de valoraciones de Estantería Lineal y elija la que mejor se adapte a la longitud de su recinto.

Para elegir su estantería ANGULAR vaya a las tablas de valoraciones de Estantería Angular y elija la que mejor se adapte a su recinto.

En este caso NO OLVIDE descontar a las dimensiones de su recinto el FONDO que haya elegido para su estantería lineal.

Remember:

To choose your LINEAR shelving unit check the measurement and pricing table for Linear Shelving Units and choose the one that best suits the length of your room.

To choose your ANGULAR shelving unit check the measurement and pricing table for Angular Shelving Units and

choose the one that best suits your room.

DO NOT FORGET to subtract from the room measurements the DEPTH of the linear shelving unit you choose.

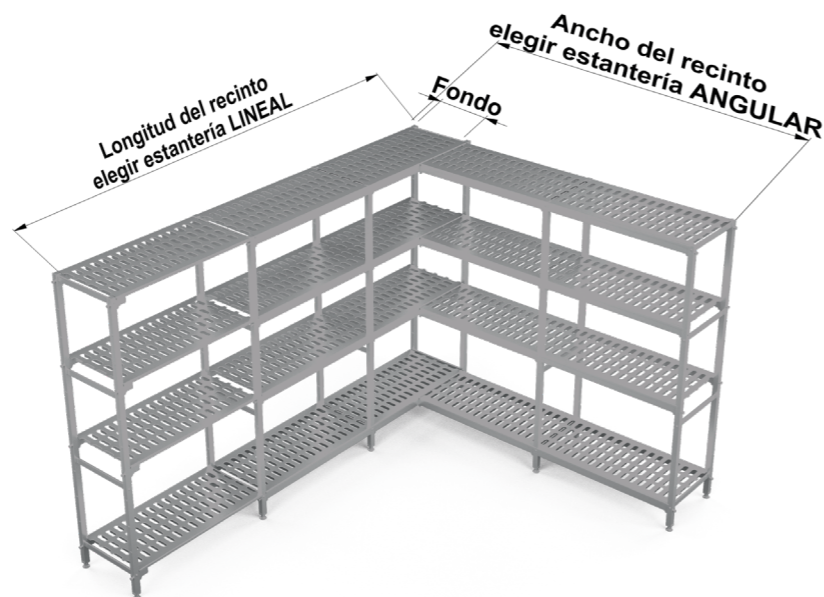

BANCADAS:

Diseñadas para almacenar cajas en recintos frigoríficos y lugares donde se debe cumplir las normativas higiénicas. Fabricadas con los mismos materiales que el resto de las estanterías. Gran capacidad de carga hasta 150 Kgrs. Altura de la base de la bancada al suelo 250 mm.

BENCHES:

Our benches are made from the same material as our shelving units, designed to store boxes in cold rooms and places where hygiene regulations must be complied with. Benches can store a load capacity of up to 150kg. The top of the bench measures 250mm from the ground.

FONDO 400 / DEPTH 400

MEDIDAS / DIMENSIONS	MODELO / MODEL	€
690x250x 400	B600F4	136 €
790x250x 400	B700F4	144 €
890x250x 400	B800F4	155 €
990x250x 400	B900F4	161 €
1090x250x 400	B1000F4	165 €
1190x250x 400	B1100F4	169 €
1290x250x 400	B1200F4	174 €
1390x250x 400	B1300F4	182 €
1490x250x 400	B1400F4	192 €
1590x250x 400	B1500F4	193 €
1690x250x 400	B1600F4	199 €

FONDO 500 / DEPTH 500

MEDIDAS / DIMENSIONS	MODELO / MODEL	€
690x250x 500	B600F5	147 €
790x250x 500	B700F5	152 €
890x250x 500	B800F5	165 €
990x250x 500	B900F5	171 €
1090x250x 500	B1000F5	176 €
1190x250x 500	B1100F5	182 €
1290x250x 500	B1200F5	185 €
1390x250x 500	B1300F5	189 €
1490x250x 500	B1400F5	204 €
1590x250x 500	B1500F5	204 €
1690x250x 500	B1600F5	207 €

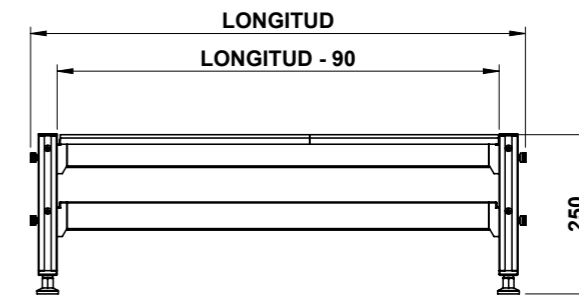

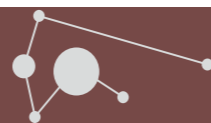

largo mm length mm	disposición de estantes depth mm	escaleras uprights	3 niveles - 3 levels		4 niveles - 4 levels	
			ref.	€	ref.	€
690	600	2	L600-4P3	242 €	L600-4P4	278 €
790	700	2	L700-4P3	259 €	L700-4P4	300 €
890	800	2	L800-4P3	268 €	L800-4P4	313 €
990	900	2	L900-4P3	287 €	L900-4P4	337 €
1090	1000	2	L1000-4P3	298 €	L1000-4P4	353 €
1190	1100	2	L1100-4P3	306 €	L1100-4P4	366 €
1290	1200	2	L1200-4P3	316 €	L1200-4P4	377 €
1390	1300	2	L1300-4P3	325 €	L1300-4P4	390 €
1490	1400	2	L1400-4P3	347 €	L1400-4P4	419 €
1590	1500	2	L1500-4P3	353 €	L1500-4P4	428 €
1690	1600	2	L1600-4P3	362 €	L1600-4P4	436 €
1725	1000/600	3	L12	469 €	L72	561 €
1825	1000/700	3	L13	506 €	L73	607 €
1925	1000/800	3	L14	502 €	L74	602 €
2025	1000/900	3	L15	510 €	L75	612 €
2125	1000/1000	3	L16	527 €	L76	636 €
2225	1100/1000	3	L17	539 €	L77	655 €
2325	1100/1100	3	L18	551 €	L78	665 €
2425	1200/1100	3	L19	567 €	L79	691 €
2525	1200/1200	3	L20	583 €	L80	713 €
2625	1300/1200	3	L21	588 €	L81	719 €
2725	1300/1300	3	L22	606 €	L82	742 €
2825	1400/1300	3	L23	617 €	L83	758 €
2925	1400/1400	3	L24	627 €	L84	771 €
3025	1500/1400	3	L25	642 €	L85	790 €
3125	1500/1500	3	L26	655 €	L86	806 €
3225	1600/1500	3	L27	773 €	L87	943 €
3325	1600/1600	3	L28	781 €	L88	954 €
3460	1100/1100/1100	4	L29	791 €	L89	966 €
3560	1200/1100/1100	4	L30	807 €	L90	989 €
3660	1200/1200/1100	4	L31	822 €	L91	1.009 €
3760	1200/1200/1200	4	L32	829 €	L92	1.019 €
3860	1300/1200/1200	4	L33	844 €	L93	1.036 €
3960	1300/1300/1200	4	L34	847 €	L94	1.042 €
4060	1300/1300/1300	4	L35	867 €	L95	1.065 €
4160	1400/1300/1300	4	L36	870 €	L96	1.070 €
4260	1400/1400/1300	4	L37	886 €	L97	1.094 €
4360	1400/1400/1400	4	L38	899 €	L98	1.112 €
4460	1500/1400/1400	4	L39	913 €	L99	1.130 €
4560	1500/1500/1400	4	L40	922 €	L100	1.142 €
4660	1500/1500/1500	4	L41	934 €	L101	1.159 €
4760	1600/1500/1500	4	L42	949 €	L102	1.176 €
4860	1600/1600/1500	4	L43	1.069 €	L103	1.317 €
4960	1600/1600/1600	4	L44	1.075 €	L104	1.323 €
5095	1300/1200/1200/1200	5	L45	1.107 €	L105	1.366 €
5195	1300/1300/1200/1200	5	L46	1.124 €	L106	1.389 €
5295	1300/1300/1300/1200	5	L47	1.129 €	L107	1.394 €
5395	1300/1300/1300/1300	5	L48	1.147 €	L108	1.418 €
5495	1400/1300/1300/1300	5	L49	1.159 €	L109	1.437 €
5595	1400/1400/1300/1300	5	L50	1.168 €	L110	1.448 €
5695	1400/1400/1400/1300	5	L51	1.180 €	L111	1.464 €
5795	1400/1400/1400/1400	5	L52	1.190 €	L112	1.475 €
5895	1500/1400/1400/1400	5	L53	1.203 €	L113	1.494 €
5995	1500/1500/1400/1400	5	L54	1.214 €	L114	1.512 €
6095	1500/1500/1500/1400	5	L55	1.229 €	L115	1.530 €
6195	1500/1500/1500/1500	5	L56	1.244 €	L116	1.547 €
6295	1600/1500/1500/1500	5	L57	1.360 €	L117	1.684 €
6395	1600/1600/1500/1500	5	L58	1.370 €	L118	1.694 €
6495	1600/1600/1600/1500	5	L59	1.489 €	L119	1.831 €
6595	1600/1600/1600/1600	5	L60	1.497 €	L120	1.843 €

Características técnicas y constructivas sujetas a variación sin previo aviso.

We reserve the right to change specifications without prior notice.



largo mm length mm	disposición de estantes depth mm	escaleras uprights	3 niveles - 3 levels		4 niveles - 4 levels	
			ref.	€	ref.	€
650	600	1	A600-4P3	216 €	A600-4P4	265 €
750	700	1	A700-4P3	233 €	A700-4P4	289 €
850	800	1	A800-4P3	242 €	A800-4P4	299 €
950	900	1	A900-4P3	259 €	A900-4P4	324 €
1050	1000	1	A1000-4P3	273 €	A1000-4P4	341 €
1150	1100	1	A1100-4P3	281 €	A1100-4P4	352 €
1250	1200	1	A1200-4P3	291 €	A1200-4P4	365 €
1350	1300	1	A1300-4P3	298 €	A1300-4P4	376 €
1450	1400	1	A1400-4P3	321 €	A1400-4P4	408 €
1550	1500	1	A1500-4P3	327 €	A1500-4P4	415 €
1650	1600	1	A1600-4P3	332 €	A1600-4P4	423 €
1680	1000/600	2	A12	441 €	A72	549 €
1780	1000/700	2	A13	479 €	A73	594 €
1880	1000/800	2	A14	473 €	A74	588 €
1980	1000/900	2	A15	483 €	A75	600 €
2080	1000/1000	2	A16	502 €	A76	623 €
2180	1100/1000	2	A17	514 €	A77	642 €
2280	1100/1100	2	A18	522 €	A78	653 €
2380	1200/1100	2	A19	539 €	A79	677 €
2480	1200/1200	2	A20	559 €	A80	656 €
2580	1300/1200	2	A21	562 €	A81	705 €
2680	1300/1300	2	A22	579 €	A82	730 €
2780	1400/1300	2	A23	593 €	A83	747 €
2880	1400/1400	2	A24	602 €	A84	757 €
2980	1500/1400	2	A25	614 €	A85	775 €
3080	1500/1500	2	A26	627 €	A86	793 €
3180	1600/1500	2	A27	747 €	A87	928 €
3280	1600/1600	2	A28	754 €	A88	941 €
3415	1100/1100/1100	3	A29	763 €	A89	953 €
3515	1200/1100/1100	3	A30	781 €	A90	976 €
3615	1200/1200/1100	3	A31	795 €	A91	995 €
3715	1200/1200/1200	3	A32	803 €	A92	1.006 €
3815	1300/1200/1200	3	A33	818 €	A93	1.022 €
3915	1300/1300/1200	3	A34	822 €	A94	1.028 €
4015	1300/1300/1300	3	A35	840 €	A95	1.053 €
4115	1400/1300/1300	3	A36	844 €	A96	1.058 €
4215	1400/1400/1300	3	A37	862 €	A97	1.081 €
4315	1400/1400/1400	3	A38	874 €	A98	1.100 €
4415	1500/1400/1400	3	A39	886 €	A99	1.116 €
4515	1500/1500/1400	3	A40	895 €	A100	1.129 €
4615	1500/1500/1500	3	A41	910 €	A101	1.147 €
4715	1600/1500/1500	3	A42	922 €	A102	1.163 €
4815	1600/1600/1500	3	A43	1.016 €	A103	1.291 €
4915	1600/1600/1600	3	A44	1.022 €	A104	1.299 €
5050	1300/1200/1200/1200	4	A45	1.054 €	A105	1.296 €
5150	1300/1300/1200/1200	4	A46	1.070 €	A106	1.318 €
5250	1300/1300/1300/1200	4	A47	1.075 €	A107	1.368 €
5350	1300/1300/1300/1300	4	A48	1.093 €	A108	1.392 €
5450	1400/1300/1300/1300	4	A49	1.107 €	A109	1.409 €
5550	1400/1400/1300/1300	4	A50	1.115 €	A110	1.421 €
5650	1400/1400/1400/1300	4	A51	1.129 €	A111	1.439 €
5750	1400/1400/1400/1400	4	A52	1.138 €	A112	1.451 €
5850	1500/1400/1400/1400	4	A53	1.152 €	A113	1.466 €
5950	1500/1500/1400/1400	4	A54	1.163 €	A114	1.486 €
6050	1500/1500/1500/1400	4	A55	1.176 €	A115	1.503 €
6150	1500/1500/1500/1500	4	A56	1.190 €	A116	1.519 €
6250	1600/1500/1500/1500	4	A57	1.310 €	A117	1.656 €
6350	1600/1600/1500/1500	4	A58	1.317 €	A118	1.667 €
6450	1600/1600/1600/1500	4	A59	1.437 €	A119	1.804 €
6550	1600/1600/1600/1600	4	A60	1.446 €	A120	1.815 €

Características técnicas y constructivas sujetas a variación sin previo aviso.

We reserve the right to change specifications without prior notice.

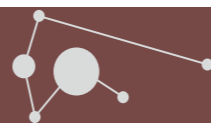

largo mm length mm	disposición de estantes depth mm	escaleras uprights	3 niveles - 3 levels ref. €	4 niveles - 4 levels ref. €
690	600	2	L600-4M3 275 €	L600-4M4 310 €
790	700	2	L700-4M3 292 €	L700-4M4 332 €
890	800	2	L800-4M3 299 €	L800-4M4 346 €
990	900	2	L900-4M3 318 €	L900-4M4 369 €
1090	1000	2	L1000-4M3 330 €	L1000-4M4 386 €
1190	1100	2	L1100-4M3 339 €	L1100-4M4 398 €
1290	1200	2	L1200-4M3 348 €	L1200-4M4 412 €
1390	1300	2	L1300-4M3 358 €	L1300-4M4 422 €
1490	1400	2	L1400-4M3 379 €	L1400-4M4 450 €
1590	1500	2	L1500-4M3 385 €	L1500-4M4 461 €
1690	1600	2	L1600-4M3 392 €	L1600-4M4 468 €
1725	1000/600	3	L132 518 €	L192 609 €
1825	1000/700	3	L133 555 €	L193 656 €
1925	1000/800	3	L134 551 €	L194 650 €
2025	1000/900	3	L135 559 €	L195 661 €
2125	1000/1000	3	L136 576 €	L196 685 €
2225	1100/1000	3	L137 588 €	L197 703 €
2325	1100/1100	3	L138 598 €	L198 714 €
2425	1200/1100	3	L139 614 €	L199 736 €
2525	1200/1200	3	L140 632 €	L200 759 €
2625	1300/1200	3	L141 636 €	L201 768 €
2725	1300/1300	3	L142 655 €	L202 791 €
2825	1400/1300	3	L143 666 €	L203 807 €
2925	1400/1400	3	L144 677 €	L204 820 €
3025	1500/1400	3	L145 691 €	L205 839 €
3125	1500/1500	3	L146 703 €	L206 855 €
3225	1600/1500	3	L147 839 €	L207 1.009 €
3325	1600/1600	3	L148 846 €	L208 1.019 €
3460	1100/1100/1100	4	L149 855 €	L209 1.029 €
3560	1200/1100/1100	4	L150 873 €	L210 1.054 €
3660	1200/1200/1100	4	L151 885 €	L211 1.070 €
3760	1200/1200/1200	4	L152 894 €	L212 1.083 €
3860	1300/1200/1200	4	L153 907 €	L213 1.102 €
3960	1300/1300/1200	4	L154 912 €	L214 1.107 €
4060	1300/1300/1300	4	L155 928 €	L215 1.130 €
4160	1400/1300/1300	4	L156 933 €	L216 1.137 €
4260	1400/1400/1300	4	L157 951 €	L217 1.159 €
4360	1400/1400/1400	4	L158 965 €	L218 1.176 €
4460	1500/1400/1400	4	L159 977 €	L219 1.193 €
4560	1500/1500/1400	4	L160 987 €	L220 1.206 €
4660	1500/1500/1500	4	L161 1.000 €	L221 1.224 €
4760	1600/1500/1500	4	L162 1.014 €	L222 1.241 €
4860	1600/1600/1500	4	L163 1.151 €	L223 1.395 €
4960	1600/1600/1600	4	L164 1.157 €	L224 1.405 €
5095	1300/1200/1200/1200	5	L165 1.187 €	L225 1.447 €
5195	1300/1300/1200/1200	5	L166 1.204 €	L226 1.469 €
5295	1300/1300/1300/1200	5	L167 1.208 €	L227 1.474 €
5395	1300/1300/1300/1300	5	L168 1.226 €	L228 1.498 €
5495	1400/1300/1300/1300	5	L169 1.240 €	L229 1.515 €
5595	1400/1400/1300/1300	5	L170 1.249 €	L230 1.527 €
5695	1400/1400/1400/1300	5	L171 1.261 €	L231 1.546 €
5795	1400/1400/1400/1400	5	L172 1.271 €	L232 1.558 €
5895	1500/1400/1400/1400	5	L173 1.284 €	L233 1.574 €
5995	1500/1500/1400/1400	5	L174 1.297 €	L234 1.593 €
6095	1500/1500/1500/1400	5	L175 1.311 €	L235 1.609 €
6195	1500/1500/1500/1500	5	L176 1.322 €	L236 1.629 €
6295	1600/1500/1500/1500	5	L177 1.459 €	L237 1.779 €
6395	1600/1600/1500/1500	5	L178 1.465 €	L238 1.790 €
6495	1600/1600/1600/1500	5	L179 1.602 €	L239 1.943 €
6595	1600/1600/1600/1600	5	L180 1.609 €	L240 1.954 €



largo mm length mm	disposición de estantes depth mm	escaleras uprights	3 niveles - 3 levels ref. €	4 niveles - 4 levels ref. €
650	600	1	A600-4M3 232 €	A600-4M4 281 €
750	700	1	A700-4M3 250 €	A700-4M4 304 €
850	800	1	A800-4M3 258 €	A800-4M4 316 €
950	900	1	A900-4M3 276 €	A900-4M4 339 €
1050	1000	1	A1000-4M3 289 €	A1000-4M4 358 €
1150	1100	1	A1100-4M3 297 €	A1100-4M4 369 €
1250	1200	1	A1200-4M3 305 €	A1200-4M4 380 €
1350	1300	1	A1300-4M3 314 €	A1300-4M4 392 €
1450	1400	1	A1400-4M3 337 €	A1400-4M4 422 €
1550	1500	1	A1500-4M3 343 €	A1500-4M4 431 €
1650	1600	1	A1600-4M3 349 €	A1600-4M4 437 €
1680	1000/600	2	A132 474 €	A192 579 €
1780	1000/700	2	A133 511 €	A193 626 €
1880	1000/800	2	A134 507 €	A194 620 €
1980	1000/900	2	A135 516 €	A195 632 €
2080	1000/1000	2	A136 533 €	A196 656 €
2180	1100/1000	2	A137 546 €	A197 673 €
2280	1100/1100	2	A138 556 €	A198 685 €
2380	1200/1100	2	A139 573 €	A199 709 €
2480	1200/1200	2	A140 589 €	A200 731 €
2580	1300/1200	2	A141 594 €	A201 736 €
2680	1300/1300	2	A142 611 €	A202 759 €
2780	1400/1300	2	A143 625 €	A203 779 €
2880	1400/1400	2	A144 633 €	A204 791 €
2980	1500/1400	2	A145 648 €	A205 807 €
3080	1500/1500	2	A146 660 €	A206 825 €
3180	1600/1500	2	A147 795 €	A207 977 €
3280	1600/1600	2	A148 803 €	A208 989 €
3415	1100/1100/1100	3	A149 814 €	A209 1.001 €
3515	1200/1100/1100	3	A150 829 €	A210 1.022 €
3615	1200/1200/1100	3	A151 844 €	A211 1.042 €
3715	1200/1200/1200	3	A152 852 €	A212 1.054 €
3815	1300/1200/1200	3	A153 867 €	A213 1.070 €
3915	1300/1300/1200	3	A154 870 €	A214 1.076 €
4015	1300/1300/1300	3	A155 886 €	A215 1.102 €
4115	1400/1300/1300	3	A156 891 €	A216 1.107 €
4215	1400/1400/1300	3	A157 910 €	A217 1.130 €
4315	1400/1400/1400	3	A158 922 €	A218 1.148 €
4415	1500/1400/1400	3	A159 934 €	A219 1.164 €
4515	1500/1500/1400	3	A160 944 €	A220 1.176 €
4615	1500/1500/1500	3	A161 958 €	A221 1.193 €
4715	1600/1500/1500	3	A162 970 €	A222 1.211 €
4815	1600/1600/1500	3	A163 1.065 €	A223 1.337 €
4915	1600/1600/1600	3	A164 1.070 €	A224 1.346 €
5050	1300/1200/1200/1200	4	A165 1.103 €	A225 1.388 €
5150	1300/1300/1200/1200	4	A166 1.119 €	A226 1.411 €
5250	1300/1300/1300/1200	4	A167 1.124 €	A227 1.417 €
5350	1300/1300/1300/1300	4	A168 1.142 €	A228 1.441 €
5450	1400/1300/1300/1300	4	A169 1.155 €	A229 1.459 €
5550	1400/1400/1300/1300	4	A170 1.163 €	A230 1.469 €
5650	1400/1400/1400/1300	4	A171 1.176 €	A231 1.487 €
5750	1400/1400/1400/1400	4	A172 1.186 €	A232 1.498 €
5850	1500/1400/1400/1400	4	A173 1.198 €	A233 1.515 €
5950	1500/1500/1400/1400	4	A174 1.211 €	A234 1.535 €
6050	1500/1500/1500/1400	4	A175 1.225 €	A235 1.551 €
6150	1500/1500/1500/1500	4	A176 1.239 €	A236 1.568 €
6250	1600/1500/1500/1500	4	A177 1.372 €	A237 1.722 €
6350	1600/1600/1500/1500	4	A178 1.382 €	A238 1.734 €
6450	1600/1600/1600/1500	4	A179 1.515 €	A239 1.885 €
6550	1600/1600/1600/1600	4	A180 1.524 €	A240 1.898 €

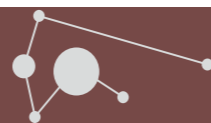

largo mm length mm	disposición de estantes depth mm	escaleras uprights	3 niveles - 3 levels ref. €	4 niveles - 4 levels ref. €	5 niveles - 5 levels ref. €
690	600	2	L600-4G3 305 €	L600-4G4 342 €	L600-4G5 379 €
790	700	2	L700-4G3 324 €	L700-4G4 366 €	L700-4G5 410 €
890	800	2	L800-4G3 331 €	L800-4G4 377 €	L800-4G5 423 €
990	900	2	L900-4G3 349 €	L900-4G4 401 €	L900-4G5 452 €
1090	1000	2	L1000-4G3 364 €	L1000-4G4 419 €	L1000-4G5 473 €
1190	1100	2	L1100-4G3 371 €	L1100-4G4 431 €	L1100-4G5 488 €
1290	1200	2	L1200-4G3 380 €	L1200-4G4 440 €	L1200-4G5 505 €
1390	1300	2	L1300-4G3 390 €	L1300-4G4 455 €	L1300-4G5 518 €
1490	1400	2	L1400-4G3 413 €	L1400-4G4 483 €	L1400-4G5 556 €
1590	1500	2	L1500-4G3 418 €	L1500-4G4 490 €	L1500-4G5 565 €
1690	1600	2	L1600-4G3 424 €	L1600-4G4 502 €	L1600-4G5 577 €
1725	1000/600	3	L252 567 €	L312 658 €	L372 748 €
1825	1000/700	3	L253 602 €	L313 704 €	L373 806 €
1925	1000/800	3	L254 598 €	L314 699 €	L374 799 €
2025	1000/900	3	L255 606 €	L315 710 €	L375 815 €
2125	1000/1000	3	L256 623 €	L316 732 €	L376 844 €
2225	1100/1000	3	L257 636 €	L317 751 €	L377 867 €
2325	1100/1100	3	L258 647 €	L318 761 €	L378 878 €
2425	1200/1100	3	L259 662 €	L319 785 €	L379 910 €
2525	1200/1200	3	L260 681 €	L320 808 €	L380 939 €
2625	1300/1200	3	L261 685 €	L321 817 €	L381 945 €
2725	1300/1300	3	L262 703 €	L322 840 €	L382 974 €
2825	1400/1300	3	L263 716 €	L323 856 €	L383 998 €
2925	1400/1400	3	L264 726 €	L324 869 €	L384 1.012 €
3025	1500/1400	3	L265 736 €	L325 885 €	L385 1.032 €
3125	1500/1500	3	L266 751 €	L326 903 €	L386 1.055 €
3225	1600/1500	3	L267 900 €	L327 1.070 €	L387 1.241 €
3325	1600/1600	3	L268 911 €	L328 1.083 €	L388 1.256 €
3460	1100/1100/1100	4	L269 918 €	L329 1.094 €	L389 1.271 €
3560	1200/1100/1100	4	L270 938 €	L330 1.118 €	L390 1.300 €
3660	1200/1200/1100	4	L271 950 €	L331 1.137 €	L391 1.321 €
3760	1200/1200/1200	4	L272 960 €	L332 1.148 €	L392 1.335 €
3860	1300/1200/1200	4	L273 971 €	L333 1.164 €	L393 1.357 €
3960	1300/1300/1200	4	L274 976 €	L334 1.169 €	L394 1.366 €
4060	1300/1300/1300	4	L275 995 €	L335 1.193 €	L395 1.394 €
4160	1400/1300/1300	4	L276 999 €	L336 1.200 €	L396 1.403 €
4260	1400/1400/1300	4	L277 1.016 €	L337 1.224 €	L397 1.431 €
4360	1400/1400/1400	4	L278 1.028 €	L338 1.241 €	L398 1.454 €
4460	1500/1400/1400	4	L279 1.042 €	L339 1.258 €	L399 1.474 €
4560	1500/1500/1400	4	L280 1.050 €	L340 1.271 €	L400 1.491 €
4660	1500/1500/1500	4	L281 1.064 €	L341 1.288 €	L401 1.512 €
4760	1600/1500/1500	4	L282 1.076 €	L342 1.305 €	L402 1.535 €
4860	1600/1600/1500	4	L283 1.230 €	L343 1.475 €	L403 1.723 €
4960	1600/1600/1600	4	L284 1.236 €	L344 1.486 €	L404 1.735 €
5095	1300/1200/1200/1200	5	L285 1.268 €	L345 1.525 €	L405 1.784 €
5195	1300/1300/1200/1200	5	L286 1.285 €	L346 1.549 €	L406 1.814 €
5295	1300/1300/1300/1200	5	L287 1.291 €	L347 1.557 €	L407 1.822 €
5395	1300/1300/1300/1300	5	L288 1.306 €	L348 1.581 €	L408 1.852 €
5495	1400/1300/1300/1300	5	L289 1.319 €	L349 1.597 €	L409 1.875 €
5595	1400/1400/1300/1300	5	L290 1.328 €	L350 1.609 €	L410 1.888 €
5695	1400/1400/1400/1300	5	L291 1.342 €	L351 1.624 €	L411 1.908 €
5795	1400/1400/1400/1400	5	L292 1.350 €	L352 1.638 €	L412 1.924 €
5895	1500/1400/1400/1400	5	L293 1.365 €	L353 1.655 €	L413 1.947 €
5995	1500/1500/1400/1400	5	L294 1.376 €	L354 1.672 €	L414 1.968 €
6095	1500/1500/1500/1400	5	L295 1.390 €	L355 1.690 €	L415 1.991 €
6195	1500/1500/1500/1500	5	L296 1.404 €	L356 1.707 €	L416 2.012 €
6295	1600/1500/1500/1500	5	L297 1.554 €	L357 1.877 €	L417 2.197 €
6395	1600/1600/1500/1500	5	L298 1.563 €	L358 1.888 €	L418 2.212 €
6495	1600/1600/1600/1500	5	L299 1.712 €	L359 2.055 €	L419 2.399 €
6595	1600/1600/1600/1600	5	L300 1.723 €	L360 2.066 €	L420 2.412 €

largo mm length mm	disposición de estantes depth mm	escaleras uprights	3 niveles - 3 levels ref. €	4 niveles - 4 levels ref. €	5 niveles - 5 levels ref. €
650	600	1	A600-4G3 249 €	A600-4G4 297 €	A600-4G5 348 €
750	700	1	A700-4G3 265 €	A700-4G4 321 €	A700-4G5 376 €
850	800	1	A800-4G3 275 €	A800-4G4 331 €	A800-4G5 391 €
950	900	1	A900-4G3 292 €	A900-4G4 355 €	A900-4G5 420 €
1050	1000	1	A1000-4G3 304 €	A1000-4G4 374 €	A1000-4G5 440 €
1150	1100	1	A1100-4G3 313 €	A1100-4G4 385 €	A1100-4G5 457 €
1250	1200	1	A1200-4G3 322 €	A1200-4G4 397 €	A1200-4G5 470 €
1350	1300	1	A1300-4G3 330 €	A1300-4G4 410 €	A1300-4G5 485 €
1450	1400	1	A1400-4G3 352 €	A1400-4G4 437 €	A1400-4G5 522 €
1550	1500	1	A1500-4G3 362 €	A1500-4G4 446 €	A1500-4G5 533 €
1650	1600	1	A1600-4G3 366 €	A1600-4G4 456 €	A1600-4G5 545 €
1680	1000/600	2	A252 508 €	A312 611 €	A372 716 €
1780	1000/700	2	A253 544 €	A313 659 €	A373 774 €
1880	1000/800	2	A254 538 €	A314 653 €	A374 768 €
1980	1000/900	2	A255 549 €	A315 664 €	A375 781 €
2080	1000/1000	2	A256 565 €	A316 687 €	A376 809 €
2180	1100/1000	2	A257 578 €	A317 705 €	A377 832 €
2280	1100/1100	2	A258 585 €	A318 718 €	A378 847 €
2380	1200/1100	2	A259 605 €	A319 741 €	A379 877 €
2480	1200/1200	2	A260 622 €	A320 807 €	A380 906 €
2580	1300/1200	2	A261 626 €	A321 770 €	A381 913 €
2680	1300/1300	2	A262 645 €	A322 793 €	A382 943 €
2780	1400/1300	2	A263 658 €	A323 809 €	A383 965 €
2880	1400/1400	2	A264 665 €	A324 823 €	A384 978 €
2980	1500/1400	2	A265 680 €	A325 841 €	A385 1.001 €
3080	1500/1500	2	A266 694 €	A326 858 €	A386 1.022 €
3180	1600/1500	2	A267 844 €	A327 1.023 €	A387 1.208 €
3280	1600/1600	2	A268 852 €	A328 1.038 €	A388 1.224 €
3415	1100/1100/1100	3	A269 862 €	A329 1.049 €	A389 1.239 €
3515	1200/1100/1100	3	A270 877 €	A330 1.071 €	A390 1.268 €
3615	1200/1200/1100	3	A271 891 €	A331 1.091 €	A391 1.291 €
3715	1200/1200/1200	3	A272 899 €	A332 1.103 €	A392 1.304 €
3815	1300/1200/1200	3	A273 913 €	A333 1.119 €	A393 1.324 €
3915	1300/1300/1200	3	A274 917 €	A334 1.125 €	A394 1.333 €
4015	1300/1300/1300	3	A275 934 €	A335 1.151 €	A395 1.363 €
4115	1400/1300/1300	3	A276 940 €	A336 1.155 €	A396 1.370 €
4215	1400/1400/1300	3	A277 958 €	A337 1.178 €	A397 1.400 €
4315	1400/1400/1400	3	A278 970 €	A338 1.196 €	A398 1.421 €
4415	1500/1400/1400	3	A279 983 €	A339 1.212 €	A399 1.444 €
4515	1500/1500/1400	3	A280 994 €	A340 1.225 €	A400 1.459 €
4615	1500/1500/1500	3	A281 1.006 €	A341 1.244 €	A401 1.479 €
4715	1600/1500/1500	3	A282 1.019 €	A342 1.259 €	A402 1.501 €
4815	1600/1600/1500	3	A283 1.112 €	A343 1.387 €	A403 1.658 €
4915	1600/1600/1600	3	A284 1.119 €	A344 1.394 €	A404 1.668 €
5050	1300/1200/1200/1200	4	A285 1.152 €	A345 1.479 €	A405 1.722 €
5150	1300/1300/1200/1200	4	A286 1.168 €	A346 1.503 €	A406 1.751 €
5250	1300/1300/1300/1200	4	A287 1.171 €	A347 1.464 €	A407 1.756 €
5350	1300/1300/1300/1300	4	A288 1.190 €	A348 1.489 €	A408 1.787 €
5450	1400/1300/1300/1300	4	A289 1.203 €	A349 1.507 €	A409 1.809 €
5550	1400/1400/1300/1300	4	A290 1.211 €	A350 1.516 €	A410 1.825 €
5650	1400/1400/1400/1300	4	A291 1.225 €	A351 1.536 €	A411 1.845 €
5750	1400/1400/1400/1400	4	A292 1.234 €	A352 1.547 €	A412 1.860 €
5850	1500/1400/1400/1400	4	A293 1.247 €	A353 1.564 €	A413 1.882 €
5950	1500/1500/1400/1400	4	A294 1.259 €	A354 1.584 €	A414 1.903 €
6050	1500/1500/1500/1400	4	A295 1.274 €	A355 1.600 €	A415 1.925 €
6150	1500/1500/1500/1500	4	A296 1.286 €	A356 1.615 €	A416 1.948 €
6250	1600/1500/1500/1500	4	A297 1.438 €	A357 1.784 €	A417 2.134 €
6350	1600/1600/1500/1500	4	A298 1.447 €	A358 1.797 €	A418 2.148 €
6450	1600/1600/1600/1500	4	A299 1.597 €	A359 1.965 €	A419 2.335 €
6550	1600/1600/1600/1600	4	A300 1.606 €	A360 1.976 €	A420 2.348 €

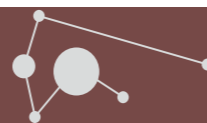

largo mm length mm	disposición de estantes depth mm	escaleras uprights	3 niveles - 3 levels ref. €		4 niveles - 4 levels ref. €	
690	600	2	L600-5P3	256 €	L600-5P4	298 €
790	700	2	L700-5P3	271 €	L700-5P4	316 €
890	800	2	L800-5P3	282 €	L800-5P4	332 €
990	900	2	L900-5P3	299 €	L900-5P4	358 €
1090	1000	2	L1000-5P3	318 €	L1000-5P4	380 €
1190	1100	2	L1100-5P3	330 €	L1100-5P4	398 €
1290	1200	2	L1200-5P3	338 €	L1200-5P4	409 €
1390	1300	2	L1300-5P3	343 €	L1300-5P4	417 €
1490	1400	2	L1400-5P3	370 €	L1400-5P4	450 €
1590	1500	2	L1500-5P3	376 €	L1500-5P4	461 €
1690	1600	2	L1600-5P3	384 €	L1600-5P4	468 €
1725	1000/600	3	L432	502 €	L492	604 €
1825	1000/700	3	L433	535 €	L493	650 €
1925	1000/800	3	L434	535 €	L494	650 €
2025	1000/900	3	L435	551 €	L495	666 €
2125	1000/1000	3	L436	562 €	L496	685 €
2225	1100/1000	3	L437	583 €	L497	714 €
2325	1100/1100	3	L438	598 €	L498	731 €
2425	1200/1100	3	L439	610 €	L499	749 €
2525	1200/1200	3	L440	623 €	L500	768 €
2625	1300/1200	3	L441	636 €	L501	784 €
2725	1300/1300	3	L442	650 €	L502	802 €
2825	1400/1300	3	L443	662 €	L503	820 €
2925	1400/1400	3	L444	677 €	L504	839 €
3025	1500/1400	3	L445	691 €	L505	855 €
3125	1500/1500	3	L446	703 €	L506	873 €
3225	1600/1500	3	L447	839 €	L507	1.029 €
3325	1600/1600	3	L448	851 €	L508	1.048 €
3460	1100/1100/1100	4	L449	864 €	L509	1.065 €
3560	1200/1100/1100	4	L450	877 €	L510	1.083 €
3660	1200/1200/1100	4	L451	879 €	L511	1.089 €
3760	1200/1200/1200	4	L452	894 €	L512	1.107 €
3860	1300/1200/1200	4	L453	903 €	L513	1.118 €
3960	1300/1300/1200	4	L454	916 €	L514	1.137 €
4060	1300/1300/1300	4	L455	928 €	L515	1.154 €
4160	1400/1300/1300	4	L456	943 €	L516	1.169 €
4260	1400/1400/1300	4	L457	957 €	L517	1.188 €
4360	1400/1400/1400	4	L458	968 €	L518	1.206 €
4460	1500/1400/1400	4	L459	1.012 €	L519	1.224 €
4560	1500/1500/1400	4	L460	996 €	L520	1.241 €
4660	1500/1500/1500	4	L461	1.010 €	L521	1.258 €
4760	1600/1500/1500	4	L462	1.021 €	L522	1.277 €
4860	1600/1600/1500	4	L463	1.162 €	L523	1.444 €
4960	1600/1600/1600	4	L464	1.169 €	L524	1.453 €
5095	1300/1200/1200/1200	5	L465	1.196 €	L525	1.487 €
5195	1300/1300/1200/1200	5	L466	1.208 €	L526	1.504 €
5295	1300/1300/1300/1200	5	L467	1.223 €	L527	1.521 €
5395	1300/1300/1300/1300	5	L468	1.235 €	L528	1.541 €
5495	1400/1300/1300/1300	5	L469	1.249 €	L529	1.558 €
5595	1400/1400/1300/1300	5	L470	1.261 €	L530	1.574 €
5695	1400/1400/1400/1300	5	L471	1.275 €	L531	1.593 €
5795	1400/1400/1400/1400	5	L472	1.288 €	L532	1.609 €
5895	1500/1400/1400/1400	5	L473	1.301 €	L533	1.629 €
5995	1500/1500/1400/1400	5	L474	1.316 €	L534	1.645 €
6095	1500/1500/1500/1400	5	L475	1.327 €	L535	1.662 €
6195	1500/1500/1500/1500	5	L476	1.340 €	L536	1.681 €
6295	1600/1500/1500/1500	5	L477	1.474 €	L537	1.837 €
6395	1600/1600/1500/1500	5	L478	1.489 €	L538	1.855 €
6495	1600/1600/1600/1500	5	L479	1.620 €	L539	2.013 €
6595	1600/1600/1600/1600	5	L480	1.636 €	L540	2.034 €



largo mm length mm	disposición de estantes depth mm	escaleras uprights	3 niveles - 3 levels ref. €		4 niveles - 4 levels ref. €	
650	600	1	A600-5P3	235 €	A600-5P4	292 €
750	700	1	A700-5P3	250 €	A700-5P4	310 €
850	800	1	A800-5P3	263 €	A800-5P4	327 €
950	900	1	A900-5P3	280 €	A900-5P4	351 €
1050	1000	1	A1000-5P3	297 €	A1000-5P4	375 €
1150	1100	1	A1100-5P3	310 €	A1100-5P4	392 €
1250	1200	1	A1200-5P3	318 €	A1200-5P4	401 €
1350	1300	1	A1300-5P3	324 €	A1300-5P4	412 €
1450	1400	1	A1400-5P3	349 €	A1400-5P4	445 €
1550	1500	1	A1500-5P3	358 €	A1500-5P4	455 €
1650	1600	1	A1600-5P3	364 €	A1600-5P4	463 €
1680	1000/600	2	A432	480 €	A492	598 €
1780	1000/700	2	A433	516 €	A493	645 €
1880	1000/800	2	A434	516 €	A494	645 €
1980	1000/900	2	A435	528 €	A495	661 €
2080	1000/1000	2	A436	543 €	A496	680 €
2180	1100/1000	2	A437	563 €	A497	709 €
2280	1100/1100	2	A438	577 €	A498	727 €
2380	1200/1100	2	A439	589 €	A499	744 €
2480	1200/1200	2	A440	604 €	A500	759 €
2580	1300/1200	2	A441	615 €	A501	779 €
2680	1300/1300	2	A442	628 €	A502	797 €
2780	1400/1300	2	A443	643 €	A503	815 €
2880	1400/1400	2	A444	656 €	A504	830 €
2980	1500/1400	2	A445	669 €	A505	850 €
3080	1500/1500	2	A446	682 €	A506	868 €
3180	1600/1500	2	A447	818 €	A507	1.022 €
3280	1600/1600	2	A448	829 €	A508	1.042 €
3415	1100/1100/1100	3	A449	844 €	A509	1.059 €
3515	1200/1100/1100	3	A450	856 €	A510	1.076 €
3615	1200/1200/1100	3	A451	862 €	A511	1.083 €
3715	1200/1200/1200	3	A452	874 €	A512	1.102 €
3815	1300/1200/1200	3	A453	880 €	A513	1.112 €
3915	1300/1300/1200	3	A454	895 €	A514	1.130 €
4015	1300/1300/1300	3	A455	910 €	A515	1.148 €
4115	1400/1300/1300	3	A456	922 €	A516	1.164 €
4215	1400/1400/1300	3	A457	934 €	A517	1.181 €
4315	1400/1400/1400	3	A458	949 €	A518	1.200 €
4415	1500/1400/1400	3	A459	962 €	A519	1.216 €
4515	1500/1500/1400	3	A460	974 €	A520	1.235 €
4615	1500/1500/1500	3	A461	988 €	A521	1.252 €
4715	1600/1500/1500	3	A462	1.001 €	A522	1.271 €
4815	1600/1600/1500	3	A463	1.120 €	A523	1.431 €
4915	1600/1600/1600	3	A464	1.129 €	A524	1.441 €
5050	1300/1200/1200/1200	4	A465	1.155 €	A525	1.474 €
5150	1300/1300/1200/1200	4	A466	1.168 €	A526	1.493 €
5250	1300/1300/1300/1200	4	A467	1.180 €	A527	1.510 €
5350	1300/1300/1300/1300	4	A468	1.193 €	A528	1.527 €
5450	1400/1300/1300/1300	4	A469	1.207 €	A529	1.546 €
5550	1400/1400/1300/1300	4	A470	1.221 €	A530	1.563 €
5650	1400/1400/1400/1300	4	A471	1.234 €	A531	1.582 €
5750	1400/1400/1400/1400	4	A472	1.247 €	A532	1.598 €
5850	1500/1400/1400/1400	4	A473	1.259 €	A533	1.614 €
5950	1500/1500/1400/1400	4	A474	1.274 €	A534	1.634 €
6050	1500/1500/1500/1400	4	A475	1.286 €	A535	1.651 €
6150	1500/1500/1500/1500	4	A476	1.300 €	A536	1.667 €
6250	1600/1500/1500/1500	4	A477	1.436 €	A537	1.827 €
6350	1600/1600/1500/1500	4	A478	1.448 €	A538	1.844 €
6450	1600/1600/1600/1500	4	A479	1.584 €	A539	2.002 €
6550	1600/1600/1600/1600	4	A480	1.596 €	A540	2.020 €

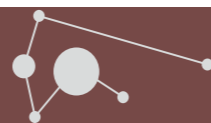

largo mm length mm	disposición de estantes depth mm	escaleras uprights	3 niveles - 3 levels ref. €		4 niveles - 4 levels ref. €	
690	600	2	L600-5M3	293 €	L600-5M4	337 €
790	700	2	L700-5M3	306 €	L700-5M4	353 €
890	800	2	L800-5M3	321 €	L800-5M4	371 €
990	900	2	L900-5M3	338 €	L900-5M4	396 €
1090	1000	2	L1000-5M3	355 €	L1000-5M4	419 €
1190	1100	2	L1100-5M3	369 €	L1100-5M4	436 €
1290	1200	2	L1200-5M3	375 €	L1200-5M4	445 €
1390	1300	2	L1300-5M3	382 €	L1300-5M4	455 €
1490	1400	2	L1400-5M3	410 €	L1400-5M4	488 €
1590	1500	2	L1500-5M3	415 €	L1500-5M4	498 €
1690	1600	2	L1600-5M3	422 €	L1600-5M4	507 €
1725	1000/600	3	L552	559 €	L612	660 €
1825	1000/700	3	L553	593 €	L613	708 €
1925	1000/800	3	L554	593 €	L614	708 €
2025	1000/900	3	L555	606 €	L615	726 €
2125	1000/1000	3	L556	617 €	L616	742 €
2225	1100/1000	3	L557	642 €	L617	771 €
2325	1100/1100	3	L558	655 €	L618	790 €
2425	1200/1100	3	L559	666 €	L619	806 €
2525	1200/1200	3	L560	681 €	L620	824 €
2625	1300/1200	3	L561	695 €	L621	842 €
2725	1300/1300	3	L562	708 €	L622	861 €
2825	1400/1300	3	L563	720 €	L623	877 €
2925	1400/1400	3	L564	732 €	L624	894 €
3025	1500/1400	3	L565	747 €	L625	912 €
3125	1500/1500	3	L566	758 €	L626	928 €
3225	1600/1500	3	L567	913 €	L627	1.107 €
3325	1600/1600	3	L568	925 €	L628	1.124 €
3460	1100/1100/1100	4	L569	940 €	L629	1.142 €
3560	1200/1100/1100	4	L570	953 €	L630	1.159 €
3660	1200/1200/1100	4	L571	958 €	L631	1.164 €
3760	1200/1200/1200	4	L572	970 €	L632	1.181 €
3860	1300/1200/1200	4	L573	978 €	L633	1.193 €
3960	1300/1300/1200	4	L574	994 €	L634	1.211 €
4060	1300/1300/1300	4	L575	1.006 €	L635	1.229 €
4160	1400/1300/1300	4	L576	1.019 €	L636	1.247 €
4260	1400/1400/1300	4	L577	1.031 €	L637	1.264 €
4360	1400/1400/1400	4	L578	1.045 €	L638	1.283 €
4460	1500/1400/1400	4	L579	1.058 €	L639	1.300 €
4560	1500/1500/1400	4	L580	1.070 €	L640	1.317 €
4660	1500/1500/1500	4	L581	1.086 €	L641	1.334 €
4760	1600/1500/1500	4	L582	1.098 €	L642	1.351 €
4860	1600/1600/1500	4	L583	1.257 €	L643	1.540 €
4960	1600/1600/1600	4	L584	1.264 €	L644	1.547 €
5095	1300/1200/1200/1200	5	L585	1.292 €	L645	1.584 €
5195	1300/1300/1200/1200	5	L586	1.304 €	L646	1.600 €
5295	1300/1300/1300/1200	5	L587	1.317 €	L647	1.615 €
5395	1300/1300/1300/1300	5	L588	1.329 €	L648	1.635 €
5495	1400/1300/1300/1300	5	L589	1.344 €	L649	1.652 €
5595	1400/1400/1300/1300	5	L590	1.356 €	L650	1.668 €
5695	1400/1400/1400/1300	5	L591	1.370 €	L651	1.688 €
5795	1400/1400/1400/1400	5	L592	1.383 €	L652	1.705 €
5895	1500/1400/1400/1400	5	L593	1.395 €	L653	1.723 €
5995	1500/1500/1400/1400	5	L594	1.409 €	L654	1.740 €
6095	1500/1500/1500/1400	5	L595	1.422 €	L655	1.756 €
6195	1500/1500/1500/1500	5	L596	1.437 €	L656	1.776 €
6295	1600/1500/1500/1500	5	L597	1.590 €	L657	1.952 €
6395	1600/1600/1500/1500	5	L598	1.603 €	L658	1.969 €
6495	1600/1600/1600/1500	5	L599	1.755 €	L659	2.146 €
6595	1600/1600/1600/1600	5	L600	1.768 €	L660	2.164 €
6595	1600/1600/1600/1600	5	L600	1.667 €	L660	2.041 €

Características técnicas y constructivas sujetas a variación sin previo aviso.

We reserve the right to change specifications without prior notice.



largo mm length mm	disposición de estantes depth mm	escaleras uprights	3 niveles - 3 levels ref. €		4 niveles - 4 levels ref. €	
650	600	1	A600-5M3	255 €	A600-5M4	311 €
750	700	1	A700-5M3	268 €	A700-5M4	329 €
850	800	1	A800-5M3	281 €	A800-5M4	347 €
950	900	1	A900-5M3	298 €	A900-5M4	370 €
1050	1000	1	A1000-5M3	316 €	A1000-5M4	395 €
1150	1100	1	A1100-5M3	329 €	A1100-5M4	413 €
1250	1200	1	A1200-5M3	337 €	A1200-5M4	420 €
1350	1300	1	A1300-5M3	342 €	A1300-5M4	430 €
1450	1400	1	A1400-5M3	369 €	A1400-5M4	464 €
1550	1500	1	A1500-5M3	375 €	A1500-5M4	472 €
1650	1600	1	A1600-5M3	382 €	A1600-5M4	481 €
1680	1000/600	2	A552	518 €	A612	634 €
1780	1000/700	2	A553	555 €	A613	682 €
1880	1000/800	2	A554	555 €	A614	682 €
1980	1000/900	2	A555	567 €	A615	700 €
2080	1000/1000	2	A556	579 €	A616	718 €
2180	1100/1000	2	A557	602 €	A617	747 €
2280	1100/1100	2	A558	614 €	A618	763 €
2380	1200/1100	2	A559	627 €	A619	781 €
2480	1200/1200	2	A560	642 €	A620	799 €
2580	1300/1200	2	A561	655 €	A621	818 €
2680	1300/1300	2	A562	666 €	A622	834 €
2780	1400/1300	2	A563	681 €	A623	852 €
2880	1400/1400	2	A564	695 €	A624	870 €
2980	1500/1400	2	A565	708 €	A625	886 €
3080	1500/1500	2	A566	720 €	A626	905 €
3180	1600/1500	2	A567	874 €	A627	1.081 €
3280	1600/1600	2	A568	886 €	A628	1.100 €
3415	1100/1100/1100	3	A569	899 €	A629	1.116 €
3515	1200/1100/1100	3	A570	913 €	A630	1.136 €
3615	1200/1200/1100	3	A571	917 €	A631	1.141 €
3715	1200/1200/1200	3	A572	929 €	A632	1.158 €
3815	1300/1200/1200	3	A573	940 €	A633	1.169 €
3915	1300/1300/1200	3	A574	953 €	A634	1.187 €
4015	1300/1300/1300	3	A575	966 €	A635	1.204 €
4115	1400/1300/1300	3	A576	978 €	A636	1.223 €
4215	1400/1400/1300	3	A577	994 €	A637	1.240 €
4315	1400/1400/1400	3	A578	1.006 €	A638	1.257 €
4415	1500/1400/1400	3	A579	1.019 €	A639	1.275 €
4515	1500/1500/1400	3	A580	1.031 €	A640	1.294 €
4615	1500/1500/1500	3	A581	1.045 €	A641	1.311 €
4715	1600/1500/1500	3	A582	1.058 €	A642	1.327 €
4815	1600/1600/1500	3	A583	1.179 €	A643	1.489 €
4915	1600/1600/1600	3	A584	1.186 €	A644	1.497 €
5050	1300/1200/1200/1200	4	A585	1.211 €	A645	1.532 €
5150	1300/1300/1200/1200	4	A586	1.225 €	A646	1.549 €
5250	1300/1300/1300/1200	4	A587	1.239 €	A647	1.567 €
5350	1300/1300/1300/1300	4	A588	1.251 €	A648	1.586 €
5450	1400/1300/1300/1300	4	A589	1.264 €	A649	1.603 €
5550	1400/1400/1300/1300	4	A590	1.278 €	A650	1.618 €
5650	1400/1400/1400/1300	4	A591	1.292 €	A651	1.638 €
5750	1400/1400/1400/1400	4	A592	1.304 €	A652	1.655 €
5850	1500/1400/1400/1400	4	A593	1.317 €	A653	1.672 €
5950	1500/1500/1400/1400	4	A594	1.329 €	A654	1.690 €
6050	1500/1500/1500/1400	4	A595	1.344 €	A655	1.707 €
6150	1500/1500/1500/1500	4	A596	1.356 €	A656	1.727 €
6250	1600/1500/1500/1500	4	A597	1.510 €	A657	1.902 €
6350	1600/1600/1500/1500	4	A598	1.522 €	A658	1.919 €
6450	1600/1600/1600/1500	4	A599	1.678 €	A659	2.096 €
6550	1600/1600/1600/1600	4	A600	1.690 €	A660	2.113 €

Características técnicas y constructivas sujetas a variación sin previo aviso.

We reserve the right to change specifications without prior notice.

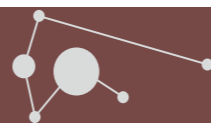

largo mm length mm	disposición de estantes depth mm	escaleras uprights	3 niveles - 3 levels ref. €	4 niveles - 4 levels ref. €	5 niveles - 5 levels ref. €
690	600	2	L600-5G3 331 €	L600-5G4 375 €	L600-5G5 418 €
790	700	2	L700-5G3 346 €	L700-5G4 392 €	L700-5G5 437 €
890	800	2	L800-5G3 359 €	L800-5G4 412 €	L800-5G5 462 €
990	900	2	L900-5G3 376 €	L900-5G4 434 €	L900-5G5 489 €
1090	1000	2	L1000-5G3 395 €	L1000-5G4 457 €	L1000-5G5 519 €
1190	1100	2	L1100-5G3 409 €	L1100-5G4 473 €	L1100-5G5 543 €
1290	1200	2	L1200-5G3 414 €	L1200-5G4 483 €	L1200-5G5 554 €
1390	1300	2	L1300-5G3 420 €	L1300-5G4 490 €	L1300-5G5 563 €
1490	1400	2	L1400-5G3 446 €	L1400-5G4 527 €	L1400-5G5 607 €
1590	1500	2	L1500-5G3 455 €	L1500-5G4 535 €	L1500-5G5 617 €
1690	1600	2	L1600-5G3 461 €	L1600-5G4 545 €	L1600-5G5 628 €
1725	1000/600	3	L672 614 €	L732 718 €	L792 820 €
1825	1000/700	3	L673 650 €	L733 763 €	L793 877 €
1925	1000/800	3	L674 650 €	L734 763 €	L794 877 €
2025	1000/900	3	L675 662 €	L735 781 €	L795 899 €
2125	1000/1000	3	L676 677 €	L736 799 €	L796 922 €
2225	1100/1000	3	L677 699 €	L737 828 €	L797 960 €
2325	1100/1100	3	L678 711 €	L738 846 €	L798 981 €
2425	1200/1100	3	L679 726 €	L739 864 €	L799 1.004 €
2525	1200/1200	3	L680 736 €	L740 879 €	L800 1.022 €
2625	1300/1200	3	L681 751 €	L741 897 €	L801 1.047 €
2725	1300/1300	3	L682 763 €	L742 916 €	L802 1.067 €
2825	1400/1300	3	L683 776 €	L743 933 €	L803 1.091 €
2925	1400/1400	3	L684 791 €	L744 951 €	L804 1.112 €
3025	1500/1400	3	L685 803 €	L745 968 €	L805 1.136 €
3125	1500/1500	3	L686 818 €	L746 987 €	L806 1.157 €
3225	1600/1500	3	L687 989 €	L747 1.181 €	L807 1.375 €
3325	1600/1600	3	L688 1.004 €	L748 1.200 €	L808 1.398 €
3460	1100/1100/1100	4	L689 1.016 €	L749 1.216 €	L809 1.420 €
3560	1200/1100/1100	4	L690 1.028 €	L750 1.235 €	L810 1.442 €
3660	1200/1200/1100	4	L691 1.032 €	L751 1.241 €	L811 1.450 €
3760	1200/1200/1200	4	L692 1.047 €	L752 1.258 €	L812 1.470 €
3860	1300/1200/1200	4	L693 1.055 €	L753 1.271 €	L813 1.486 €
3960	1300/1300/1200	4	L694 1.067 €	L754 1.288 €	L814 1.508 €
4060	1300/1300/1300	4	L695 1.081 €	L755 1.305 €	L815 1.530 €
4160	1400/1300/1300	4	L696 1.094 €	L756 1.322 €	L816 1.551 €
4260	1400/1400/1300	4	L697 1.108 €	L757 1.340 €	L817 1.572 €
4360	1400/1400/1400	4	L698 1.120 €	L758 1.357 €	L818 1.596 €
4460	1500/1400/1400	4	L699 1.105 €	L759 1.375 €	L819 1.615 €
4560	1500/1500/1400	4	L700 1.148 €	L760 1.393 €	L820 1.639 €
4660	1500/1500/1500	4	L701 1.160 €	L761 1.411 €	L821 1.660 €
4760	1600/1500/1500	4	L702 1.174 €	L762 1.428 €	L822 1.684 €
4860	1600/1600/1500	4	L703 1.354 €	L763 1.634 €	L823 1.914 €
4960	1600/1600/1600	4	L704 1.359 €	L764 1.641 €	L824 1.924 €
5095	1300/1200/1200/1200	5	L705 1.387 €	L765 1.678 €	L825 1.968 €
5195	1300/1300/1200/1200	5	L706 1.400 €	L766 1.694 €	L826 1.991 €
5295	1300/1300/1300/1200	5	L707 1.413 €	L767 1.711 €	L827 2.012 €
5395	1300/1300/1300/1300	5	L708 1.425 €	L768 1.731 €	L828 2.036 €
5495	1400/1300/1300/1300	5	L709 1.439 €	L769 1.748 €	L829 2.055 €
5595	1400/1400/1300/1300	5	L710 1.453 €	L770 1.764 €	L830 2.078 €
5695	1400/1400/1400/1300	5	L711 1.464 €	L771 1.782 €	L831 2.099 €
5795	1400/1400/1400/1400	5	L712 1.476 €	L772 1.799 €	L832 2.123 €
5895	1500/1400/1400/1400	5	L713 1.492 €	L773 1.817 €	L833 2.144 €
5995	1500/1500/1400/1400	5	L714 1.504 €	L774 1.835 €	L834 2.166 €
6095	1500/1500/1500/1400	5	L715 1.516 €	L775 1.853 €	L835 2.188 €
6195	1500/1500/1500/1500	5	L716 1.531 €	L776 1.870 €	L836 2.208 €
6295	1600/1500/1500/1500	5	L717 1.704 €	L777 2.065 €	L837 2.429 €
6395	1600/1600/1500/1500	5	L718 1.717 €	L778 2.084 €	L838 2.451 €
6495	1600/1600/1600/1500	5	L719 1.890 €	L779 2.281 €	L839 2.671 €
6595	1600/1600/1600/1600	5	L720 1.902 €	L780 2.298 €	L840 2.692 €

largo mm length mm	disposición de estantes depth mm	escaleras uprights	3 niveles - 3 levels ref. €	4 niveles - 4 levels ref. €	5 niveles - 5 levels ref. €
650	600	1	A600-5G3 275 €	A600-5G4 330 €	A600-5G5 387 €
750	700	1	A700-5G3 288 €	A700-5G4 348 €	A700-5G5 412 €
850	800	1	A800-5G3 299 €	A800-5G4 366 €	A800-5G5 432 €
950	900	1	A900-5G3 318 €	A900-5G4 390 €	A900-5G5 462 €
1050	1000	1	A1000-5G3 335 €	A1000-5G4 414 €	A1000-5G5 489 €
1150	1100	1	A1100-5G3 348 €	A1100-5G4 431 €	A1100-5G5 512 €
1250	1200	1	A1200-5G3 355 €	A1200-5G4 437 €	A1200-5G5 522 €
1350	1300	1	A1300-5G3 363 €	A1300-5G4 447 €	A1300-5G5 534 €
1450	1400	1	A1400-5G3 387 €	A1400-5G4 483 €	A1400-5G5 578 €
1550	1500	1	A1500-5G3 395 €	A1500-5G4 490 €	A1500-5G5 589 €
1650	1600	1	A1600-5G3 401 €	A1600-5G4 502 €	A1600-5G5 600 €
1680	1000/600	2	A672 557 €	A732 673 €	A792 791 €
1780	1000/700	2	A673 590 €	A733 720 €	A793 850 €
1880	1000/800	2	A674 590 €	A734 720 €	A794 850 €
1980	1000/900	2	A675 605 €	A735 736 €	A795 872 €
2080	1000/1000	2	A676 616 €	A736 754 €	A796 892 €
2180	1100/1000	2	A677 639 €	A737 784 €	A797 928 €
2280	1100/1100	2	A678 653 €	A738 802 €	A798 951 €
2380	1200/1100	2	A679 665 €	A739 820 €	A799 973 €
2480	1200/1200	2	A680 680 €	A740 839 €	A800 996 €
2580	1300/1200	2	A681 694 €	A741 855 €	A801 1.017 €
2680	1300/1300	2	A682 705 €	A742 873 €	A802 1.039 €
2780	1400/1300	2	A683 719 €	A743 890 €	A803 1.060 €
2880	1400/1400	2	A684 731 €	A744 907 €	A804 1.083 €
2980	1500/1400	2	A685 746 €	A745 924 €	A805 1.105 €
3080	1500/1500	2	A686 757 €	A746 943 €	A806 1.126 €
3180	1600/1500	2	A687 929 €	A747 1.140 €	A807 1.346 €
3280	1600/1600	2	A688 944 €	A748 1.157 €	A808 1.368 €
3415	1100/1100/1100	3	A689 958 €	A749 1.174 €	A809 1.390 €
3515	1200/1100/1100	3	A690 970 €	A750 1.191 €	A810 1.413 €
3615	1200/1200/1100	3	A691 974 €	A751 1.197 €	A811 1.420 €
3715	1200/1200/1200	3	A692 988 €	A752 1.213 €	A812 1.442 €
3815	1300/1200/1200	3	A693 998 €	A753 1.226 €	A813 1.456 €
3915	1300/1300/1200	3	A694 1.011 €	A754 1.245 €	A814 1.476 €
4015	1300/1300/1300	3	A695 1.022 €	A755 1.261 €	A815 1.499 €
4115	1400/1300/1300	3	A696 1.036 €	A756 1.279 €	A816 1.521 €
4215	1400/1400/1300	3	A697 1.049 €	A757 1.297 €	A817 1.545 €
4315	1400/1400/1400	3	A698 1.062 €	A758 1.316 €	A818 1.565 €
4415	1500/1400/1400	3	A699 1.075 €	A759 1.332 €	A819 1.589 €
4515	1500/1500/1400	3	A700 1.089 €	A760 1.349 €	A820 1.609 €
4615	1500/1500/1500	3	A701 1.103 €	A761 1.367 €	A821 1.633 €
4715	1600/1500/1500	3	A702 1.115 €	A762 1.384 €	A822 1.653 €
4815	1600/1600/1500	3	A703 1.236 €	A763 1.546 €	A823 1.854 €
4915	1600/1600/1600	3	A704 1.244 €	A764 1.554 €	A824 1.866 €
5050	1300/1200/1200/1200	4	A705 1.269 €	A765 1.590 €	A825 1.908 €
5150	1300/1300/1200/1200	4	A706 1.283 €	A766 1.607 €	A826 1.931 €
5250	1300/1300/1300/1200	4	A707 1.296 €	A767 1.622 €	A827 1.953 €
5350	1300/1300/1300/1300	4	A708 1.310 €	A768 1.641 €	A828 1.975 €
5450	1400/1300/1300/1300	4	A709 1.321 €	A769 1.658 €	A829 1.998 €
5550	1400/1400/1300/1300	4	A710 1.334 €	A770 1.678 €	A830 2.020 €
5650	1400/1400/1400/1300	4	A711 1.348 €	A771 1.694 €	A831 2.042 €
5750	1400/1400/1400/1400	4	A712 1.360 €	A772 1.711 €	A832 2.062 €
5850	1500/1400/1400/1400	4	A713 1.373 €	A773 1.731 €	A833 2.086 €
5950	1500/1500/1400/1400	4	A714 1.388 €	A774 1.748 €	A834 2.107 €
6050	1500/1500/1500/1400	4	A715 1.401 €	A775 1.764 €	A835 2.131 €
6150	1500/1500/1500/1500	4	A716 1.415 €	A776 1.782 €	A836 2.151 €
6250	1600/1500/1500/1500	4	A717 1.587 €	A777 1.978 €	A837 2.371 €
6350	1600/1600/1500/1500	4	A718 1.600 €	A778 1.996 €	A838 2.394 €
6450	1600/1600/1600/1500	4	A719 1.772 €	A779 2.193 €	A839 2.613 €
6550	1600/1600/1600/1600	4	A720 1.784 €	A780 2.208 €	A840 2.634 €

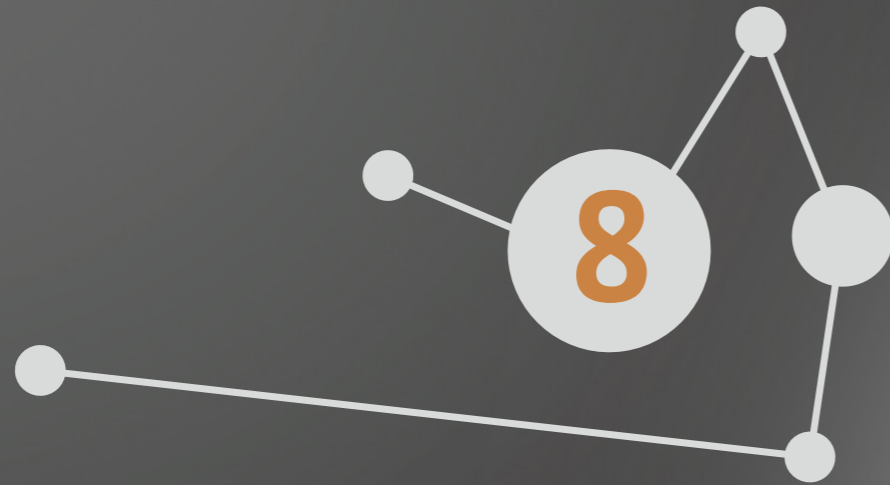

EQUIPOS FRIGORÍFICOS
COOLING UNITS

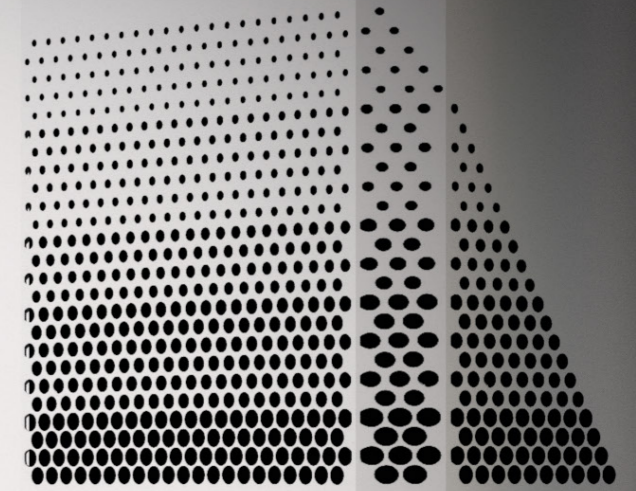

CORECO

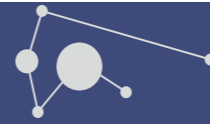

Equipo compacto de carga reducida de R-290, menor a 200 g.
 Diseño tropicalizado para temperatura ambiente de 45 °C.
 Válvula de expansión termostática.
 Desescarche por gas caliente con control de temperatura.



Diseño

La nueva gama de equipos monoblock incorpora componentes de última tecnología en una construcción muy compacta que se integra en el panel de la cámara frigorífica.

Su diseño estilizado permite aprovechar al máximo el espacio de almacenamiento, y su estructura aligerada reduce al mínimo los puentes térmicos y las pérdidas de frío.



Alta eficiencia energética

Junto al excelente rendimiento termodinámico del refrigerante R-290, los equipos monoblock integran componentes de bajo consumo, como ventiladores electrónicos, iluminación led o compresores de alta eficiencia.



Sostenibilidad medioambiental

El R-290 o propano es un hidrocarburo utilizado habitualmente en refrigeración doméstica y pequeñas aplicaciones de refrigeración comercial. Gracias a su bajo impacto medioambiental y sus excelentes propiedades termodinámicas, el R-290 es la mejor opción en pequeñas cámaras frigoríficas.



Seguridad y fiabilidad

Los equipos monoblock de INTARCON cumplen con todos los requisitos de seguridad, poseen una ínfima carga de refrigerante R-290, y cuentan con componentes antideflagrantes, dispositivos de limitación de presión y temperatura.

Propano

El propano o R-290, es un hidrocarburo utilizado como refrigerante en equipos compactos de refrigeración comercial. Tiene un bajo impacto medio ambiental y unas excelentes propiedades termodinámicas.

- Potencial de calentamiento atmosférico PCA (GWP)= 3
- Punto ebullición a 1,013 bar (°C):-42,10
- Deslizamiento de temperatura (°C): 0
- Clasificación seguridad: A3. No tóxico pero extremadamente inflamable.
- El Reglamento de Instalaciones Frigoríficas (RSIF) RD 552/2019 y el Comité Electrotécnico Internacional IEC 60335 admiten el uso de hasta 0,5 kg en equipos compactos de refrigeración comercial.

Controlador electrónico

La regulación electrónica XW60LH, de serie en nuestros equipos compactos comerciales de puerta, es un avanzado controlador de reducido tamaño, que incluye las siguientes funciones:



Control de temperatura con registro de temperaturas máxima y mínima.

Función "Jet Cool" de enfriamiento rápido.

Modo de funcionamiento nocturno.

4 relés de salida para: compresor, ventilador, desescarche y luz.

3 sondas NTC de temperatura para termostato, desescarche y condensación.

Luz led de cámara integrada

Luz led de cámara de gran eficiencia, integrada en el equipo, que se activa automáticamente al abrirse la puerta de la cámara.

Descripción

Equipos ultra compactos monoblocks diseñados para minicámaras frigoríficas de refrigeración y congelación, para montaje en ventana sobre la pared de la cámara.

Características

- Alimentación 230 V-I-50 Hz.
- Carga de refrigerante R-290 inferior a 200 g.
- Compresor hermético alternativo.
- Motoventiladores electrónicos EC.
- Presostato de alta.
- Expansión por válvula termostática.
- Desescarche por inyección de gas caliente.
- Bandeja de condensados en acero inoxidable.
- Evaporación automática de condensados.
- Luz led de cámara con microinterruptor de puerta.
- Tampón desmontable incluido.
- Cable de resistencia de puerta (solo modelos BCV).
- Regulación electrónica multifunción.

serie MCV / BCV

Esquema de instalación

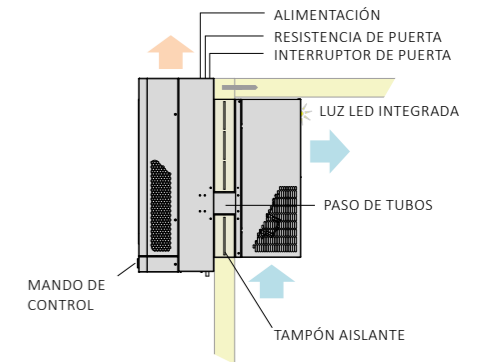

230 V-I-50 Hz | Media temperatura | R-290

Serie / Modelo	Compresor		Potencia frigorífica / Volumen cámara, según temperatura de cámara ⁽¹⁾				Potencia absorb. nominal (kW)	Intens. máxima absorb. (A)	Caudal evap. (m³/h)	Carga refrig. (kg)	Peso (kg)	Nivel presión sonora dB(A) ⁽²⁾	PVP (€)			
	CV	Tensión	0 °C	5 °C	10 °C											
R-290	MCV-LD-0 009	1/3	230 V-I	635	5	740	7	850	12	0,40	3,5	300	<0,10	38	29	2.139 €
	MCV-LD-1 012	1/2	230 V-I	1 050	9	1 220	15	1 410	27	0,52	3,3	500	<0,10	56	29	2.574 €
	MCV-LD-1 017	3/4	230 V-I	1 340	14	1 560	21	1 780	36	0,68	4,3	500	<0,15	57	31	2.870 €
	MCV-LD-2 026	2	230 V-I	1 824	21	2 170	34	2 540	58	0,94	5,9	950	<0,15	86	35	3.642 €
	MCV-LD-2 034	2 1/2	230 V-I	2 215	27	2 618	43	2 960	70	1,31	9,0	950	<0,20	86	35	4.565 €

230 V-I-50 Hz | Baja temperatura | R-290

Serie / Modelo	Compresor		Potencia frigorífica / Volumen cámara, según temperatura de cámara ⁽¹⁾				Potencia absorb. nominal (kW)	Intens. máxima absorb. (A)	Caudal evap. (m³/h)	Carga refrig. (kg)	Peso (kg)	Nivel presión sonora dB(A) ⁽²⁾	PVP (€)			
	CV	Tensión	-25 °C	-20 °C	-15 °C											
R-290	BCV-LD-0 014	3/4	230 V-I	370	1	440	2	520	4	0,38	2,93	300	<0,10	38	29	2.539 €
	BCV-LD-1 017	3/4	230 V-I	540	2	660	5	790	8	0,48	3,61	500	<0,10	57	29	2.821 €
	BCV-LD-1 028	1 1/4	230 V-I	770	4	920	9	1 090	15	0,73	6,10	500	<0,15	64	31	3.106 €
	BCV-LD-2 034	1 1/2	230 V-I	985	7	1 210	14	1 470	25	0,97	12,69	950	<0,20	86	34	3.333 €

Opcionales

- Tratamiento anticorrosión en epoxi de la batería de evaporación. + 6%

Dimensiones

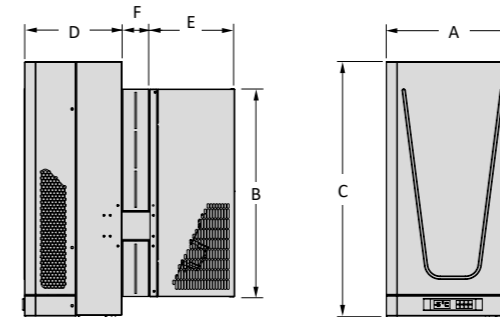

Dimensiones (mm)	A	B	C	D	E	F
serie 0	420	596	803	237	207	86
serie 1	420	656	803	307	270	86
serie 2	620	676	764	343	310	106

⁽¹⁾ Las prestaciones nominales están referidas al funcionamiento con temperaturas de cámara de 0 °C (MT) o -20 °C (BT), y temperatura exterior de 35 °C. Volumen de cámara recomendado para cámaras con suelo y aislamiento de 80 mm en MT o 100 mm en BT, densidad de mercancía de 250 kg/m³ con una rotación diaria del 10% a una temperatura de entrada de 25 °C en MT y -15 °C en BT.

⁽²⁾ Nivel sonoro máximo referido a nivel de presión acústica en dB(A), medido en campo abierto a 10 m de distancia de la fuente.

Marcos de montaje

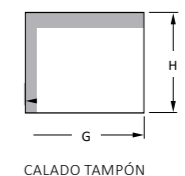

Dimensiones (mm)	G	H
serie 0	400	600
serie 1	400	660
serie 2	600	680

CALADO TAMPÓN



Equipo compacto de carga reducida de refrigerante, menor a 2 kg.
 Diseño tropicalizado para temperatura ambiente de 45 °C.
 Válvula de expansión termostática.
 Desescarche por gas caliente con control de temperatura.
 Equipos exentos de control de fugas.

Descripción Equipos compactos monoblock para montaje sobre pared en cámaras frigoríficas de pequeño tamaño de refrigeración y congelación.

- Características**
- Alimentación 230 V-I-50 Hz o 400 V-III-50 Hz.
 - Carga de refrigerante R-134a o R-449A, inferior a 2 kg.
 - Compresor hermético alternativo.
 - Presostatos de alta y baja presión.
 - Expansión por válvula termostática.
 - Protección magnetotérmica.
 - Desescarche por inyección de gas caliente.
 - Bandeja de condensados en acero inoxidable.
 - Evaporación automática de condensados.
 - Luz de cámara y cable de interruptor de puerta.
 - Cable de resistencia de puerta (solo modelos BCV).
 - Tampón desmontable incluido.
 - Regulación electrónica multifunción.

Serie CV-N Equipos compactos preparados para montaje en ventana y equipados con tampón aislante desmontable para montaje acaballado.

Serie CV-C Versión centrífuga con condensador equipado con turbina centrífuga para la conducción al exterior del aire caliente de condensación.

Serie CV-I Equipos compactos aptos para intemperie para instalación en exterior en pequeñas cámaras frigoríficas a temperatura positiva o negativa.

Esquemas de instalación

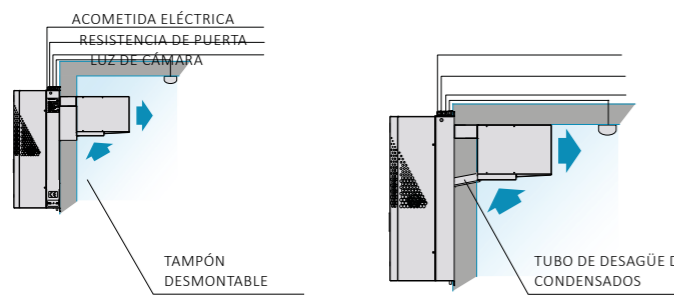

Montaje tampón
 Se suministra de serie un tampón desmontable para montaje directo sobre ventana en la cámara frigorífica.

Montaje acaballado (excepto serie 0)
 Es posible realizar un montaje acaballado de forma sencilla, simplemente preparando un marco para su instalación y posteriormente colocando el techo de la cámara.

Controlador electrónico

Los equipos intarblock incorporan de serie el avanzado controlador electrónico XWING.



Control de temperatura con registro de temperaturas máxima y mínima.

Función "Jet Cool" de enfriamiento rápido.
 Modo de funcionamiento nocturno.

Versión centrífuga

Los equipos de la serie intarblock centrífuga incorporan una turbina centrífuga para permitir la conducción hacia el exterior del aire caliente de descarga mediante conductos.

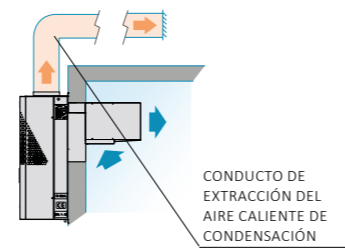

Conductos de extracción de aire

Dimensiones recomendadas para conductos de descarga en chapa, PVC, o panel de lana de vidrio, de 20 m de longitud (cada codo a 90° equivale a 5 m de longitud). Para conductos flexibles o semirrígidos se recomienda utilizar una dimensión mayor.

- serie 0: 200 x 150 mm.
- serie 1: 200 x 200 mm.
- serie 2: Ø 200 ó 250 x 150 mm.
- serie 3: Ø 250 ó 300 x 200 mm.

230 V-I-50 Hz* / 400 V-III-50 Hz | Media temperatura | R134a

VERSIÓN AXIAL	COMPRESOR		POTENCIA FRIGORÍFICA / VOLUMEN CÁMARA, SEGÚN TEMPERATURA DE CÁMARA (1)						POTENCIA ABSORB. NOMINAL (kW)	INTENS. MÁXIMA ABSORB. (A)	CAUDAL EVAP. (m³/h)	CARGA REFRIG. (kg)	PESO (kg)	NIVEL PRESIÓN SONORA dB(A) (2)	PVP (€) AXIAL
			0°C		5°C		10°C								
			W	m³	W	m³	W	m³							
MCV-NY-0 010	3/8	230 V-I	610	4,0	758	7,0	907	12	0,43	4,5	300	<1,0	36	28	1.876 €
MCV-NY-0 015	1/2	230 V-I	794	6,0	961	10	1139	18	0,53	5,5	300	<1,0	38	29	2.166 €
MCV-NY-1 015	1/2	230 V-I	972	7,2	1199	14	1453	23	0,57	5,6	500	<1,0	60	29	2.388 €
MCV-NY-1 026	3/4	230 V-I	1281	12	1565	19	1859	30	0,81	9,3	500	<1,0	69	34	2.664 €
MCV-NY-1 033	1	230 V-I	1454	16	1743	25	2037	41	0,92	9,5	500	<1,0	70	34	2.814 €
MCV-NY-2 033	1	230 V-I	1790	23	2163	36	2573	57	1,09	10,3	950	<1,5	88	35	3.467 €
MCV-NY-2 053	1 1/2	230 V-I *	2153	31	2609	41	3103	72	1,46	12,9	950	<1,5	89	39	3.882 €
MCV-NY-3 053	1 1/2	230 V-I *	2489	35	3103	53	3743	83	1,51	13,1	1300	<2,0	117	38	4.484 €
MCV-NY-3 074	2	230 V-I *	3239	36	3938	70	4667	97	1,89	17,1	1300	<2,0	114	41	4.870 €
MCV-NY-3 108	5	400 V-III	3927	42	4725	110	5539	130	2,48	18,6	1300	<2,0	116	43	5.186 €

230 V-I-50 Hz* / 400 V-III-50 Hz | Baja temperatura | R449A

VERSIÓN AXIAL	COMPRESOR		POTENCIA FRIGORÍFICA / VOLUMEN CÁMARA, SEGÚN TEMPERATURA DE CÁMARA (1)						POTENCIA ABSORB. NOMINAL (kW)	INTENS. MÁXIMA ABSORB. (A)	CAUDAL EVAP. (m³/h)	CARGA REFRIG. (kg)	PESO (kg)	NIVEL PRESIÓN SONORA dB(A) (2)	PVP (€) AXIAL
			-25°C		-20°C		-15°C								
			W	m³	W	m³	W	m³							
BCV-NG-0 018	5/8	230 V-I	382	0,6	486	1,5	596	2,8	0,50	4,7	300	<1,0	38	33	2.525 €
BCV-NG-1 026	3/4	230 V-I	550	2,1	721	4,3	888	7,6	0,84	8,5	550	<1,0	60	38	2.909 €
BCV-NG-1 034	1 1/4	230 V-I	697	3,2	882	6,1	1047	10	1,05	11,0	550	<1,0	60	40	2.990 €
BCV-NG-2 034	1 1/4	230 V-I	1053	3,8	1049	7,7	1341	14	1,11	11,9	950	<1,5	89	41	3.192 €
BCV-NG-2 055	1 3/4	230 V-I *	1155	8	1560	15	1960	26	1,6	17,5	950	<1	96	42	3.820 €
BCV-NG-2 075	2	230 V-I *	1453	11	1835	18	2245	31	2,0	25,5	950	<1	101	43	4.186 €
BCV-NG-3 075	2	230 V-I *	1680	13	2150	23	2635	38	2,2	12,3	1300	<1,5	113	43	4.655 €
BCV-NG-3 096	3 1/2	400 V-III	2022	18	2492	32	2942	54	2,39	12,1	1300	<1,5	129	50	4.951 €

Opcionales

- Cambio a alimentación 400 V-III-50 Hz. + 5%
- Microinterruptor de puerta. + 63 €
- Compuerta antirretorno (equipos centrífugos). + 67 €
- Adaptación de impulsión de aire a conducto circular. + 123 €
- Tratamiento anticorrosión en epoxi de la batería de evaporación. + 6%
- Refrigerante R-452A en BT. + 2%

(1) Las prestaciones nominales están referidas al funcionamiento con temperatura de cámara de 0°C (MT) y -20°C (BT), y temperatura exterior de 35°C. Volumen de cámara estimado según condiciones de las bases de cálculo (pág. VI).

(2) Presión sonora en dB(A) en campo abierto a 10 m de la fuente.

(3) Presión estática disponible en conductos de expulsión.

* Unidades disponibles en tensión 400 V-III-50 Hz.

Dimensiones

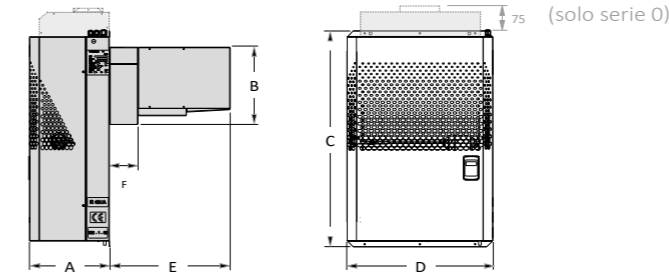

Dimensiones (mm)	A	B	C	D	E	F	Embocadura turbina
serie 0	306	510	683	420	250	50	185 x 115
serie 1	340	330	880	400	514	122	185 x 115
serie 2	340	330	920	620	514	122	230 x 130
serie 3	365	470	940	735	514	122	2x 185 x 115

Marcos de montaje



Dimensiones	G	H	I	J	K	L	M
serie 0	405	515			n/a		
serie 1	380	335	75	41	295	13	233
serie 2	600	335	75	36	523	13	233
serie 3	710	475	75	41	611	22	356

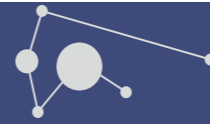

Carga reducida de refrigerante menor a 200 g.
 Diseño tropicalizado para temperatura ambiente de 45 °C.
 Válvula de expansión termostática.
 Desescarche por gas caliente con control de temperatura.

Descripción Equipos compactos monoblock para cámaras frigoríficas de pequeño tamaño de refrigeración y congelación, para montaje en techo.

- Características
- Alimentación 230 V-I-50 Hz.
 - Carga de refrigerante R-290, inferior a 200 g.
 - Compresor hermético alternativo.
 - Presostatos de alta.
 - Expansión por válvula termostática.
 - Protección magnetotérmica.
 - Desescarche por inyección de gas caliente.
 - Bandeja de condensados en acero inoxidable.
 - Evaporación automática de condensados.
 - Luz led de cámara con microinterruptor de puerta.
 - Cable de resistencia de puerta (solo modelos BCR).
 - Cajón de evaporación en panel sándwich de 50 mm de espuma de poliuretano, revestido interiormente con chapa de acero prelacado.
 - Regulación electrónica multifunción.

Esquema de instalación

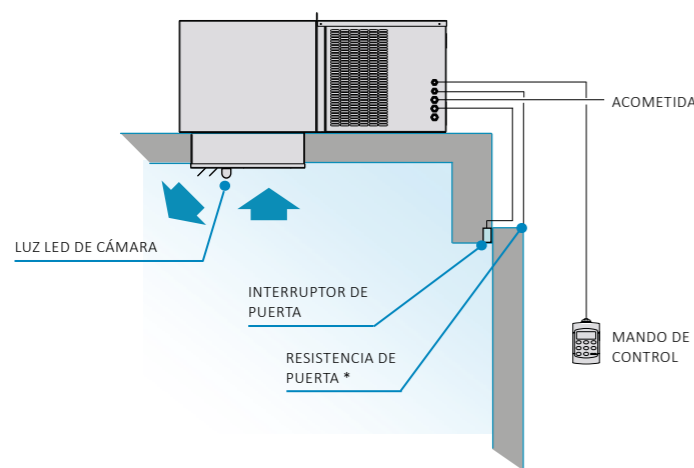

* Resistencia de puerta solo en modelos de baja temperatura.

Propano

El propano o R-290, es un hidrocarburo utilizado como refrigerante en equipos compactos de refrigeración comercial. Tiene un bajo impacto medio ambiental y unas excelentes propiedades termodinámicas.

- Potencial de calentamiento atmosférico PCA (GWP) = 3
- Punto ebullición a 1,013 bar (°C): -42,10
- Deslizamiento de temperatura (°C): 0
- Clasificación seguridad: A3. No tóxico pero extremadamente inflamable.
- El Reglamento de Instalaciones Frigoríficas (RSIF) RD 552/2019 y el Comité Electrotécnico Internacional IEC 60335 admiten el uso de hasta 0,5 kg en equipos compactos de refrigeración comercial.

Controlador electrónico

Los equipos intartop incorporan de serie el avanzado controlador electrónico XWING:



- Mando multifunción de control digital a distancia.
- Control de temperatura con registro de temperaturas máxima y mínima.
- Función "Jet Cool" de enfriamiento rápido.
- Modo de funcionamiento nocturno.

Luz led de cámara integrada

Luz led de cámara de gran eficiencia, integrada en el equipo, que se activa automáticamente al abrirse la puerta de la cámara.

230 V-I-50 Hz | Media temperatura | R-290

serie MCR / BCR

Serie / Modelo	Compresor		Potencia frigorífica / Volumen cámara, según temperatura de cámara ⁽¹⁾						Potencia absorb. nominal (kW)	Intens. máxima absorb. (A)	Caudal evap. (m³/h)	Carga refrig. (kg)	Peso (kg)	Nivel presión sonora dB(A) ⁽²⁾	PVP (€)
	CV	Tensión	0 °C		5 °C		10 °C								
			W	m³	W	m³	W	m³							
MCR-ND-0 009	1/3	230 V-I	670	5	780	7	900	12	0,39	3,6	300	< 0,10	63	29	2.253 €
MCR-ND-1 012	1/2	230 V-I	1 060	9	1 240	15	1 435	27	0,53	3,4	600	< 0,10	73	29	2.735 €
MCR-ND-1 017	3/4	230 V-I	1 370	14	1 585	21	1 815	36	0,68	4,5	600	< 0,15	73	31	3.050 €
MCR-ND-2 026	2	230 V-I	1 850	21	2 200	34	2 577	58	0,98	5,9	1 150	< 0,15	96	35	4.073 €
MCR-ND-2 034	2 1/2	230 V-I	2 240	27	2 650	43	2 995	70	1,35	9,0	1 150	< 0,20	96	35	5.122 €

230 V-I-50 Hz | Baja temperatura | R-290

Serie / Modelo	Compresor		Potencia frigorífica / Volumen cámara, según temperatura de cámara ⁽¹⁾						Potencia absorb. nominal (kW)	Intens. máxima absorb. (A)	Caudal evap. (m³/h)	Carga refrig. (kg)	Peso (kg)	Nivel presión sonora dB(A) ⁽²⁾	PVP (€)
	CV	Tensión	-25 °C		-20 °C		-15 °C								
			W	m³	W	m³	W	m³							
BCR-ND-0 014	3/4	230 V-I	385	1	460	2	550	4	0,39	3,3	300	< 0,10	65	29	2.654 €
BCR-ND-1 017	3/4	230 V-I	540	2	660	5	800	8	0,49	3,5	600	< 0,10	73	29	2.981 €
BCR-ND-1 028	1 1/4	230 V-I	770	4	925	9	1 100	15	0,73	6,0	600	< 0,15	80	31	3.266 €
BCR-ND-2 034	1 1/2	230 V-I	985	7	1 215	14	1 475	25	0,99	9,3	1 150	< 0,20	96	34	4.011 €

Opcionales

- Tratamiento anticorrosión en epoxi de la batería de evaporación. + 6%

Dimensiones

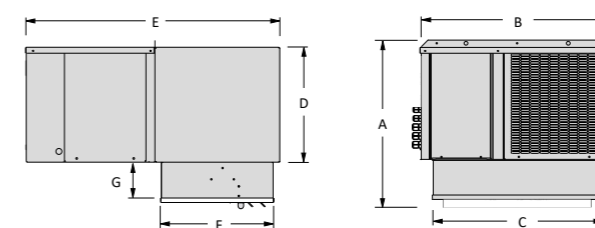

Dimensiones (mm)	A	B	C	D	E	F	G
serie 0	480	600	430	330	790	375	100
serie 1	580	660	585	385	850	380	135
serie 2	665	830	755	470	850	380	135

⁽¹⁾ Las prestaciones nominales están referidas al funcionamiento con temperaturas de cámara de 0 °C (MT) o -20 °C (BT), y temperatura exterior de 35 °C. Volumen de cámara recomendado para cámaras con suelo y aislamiento de 80 mm en MT o 100 mm en BT, densidad de mercancía de 250 kg/m³ con una rotación diaria del 10% a una temperatura de entrada de 25 °C en MT y -15 °C en BT.

⁽²⁾ Nivel sonoro máximo referido a nivel de presión acústica en dB(A), medido en campo abierto a 10 m de distancia de la fuente.

Marcos de montaje

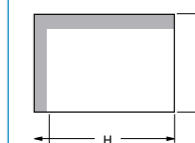

Dimensiones (mm)	H	I
serie 0	435	380
serie 1	590	385
serie 2	760	385

CALADO EN TECHO



Descripción Equipos compactos monoblock para cámaras frigoríficas de pequeño tamaño de refrigeración y congelación, para montaje en techo.

- Características**
- Alimentación 230 V-I-50 Hz o 400 V-III-50 Hz.
 - Carga de refrigerante R-134a o R-449A, inferior a 1,5 kg.
 - Compresor hermético alternativo.
 - Presostatos de alta y baja presión.
 - Expansión por válvula termostática.
 - Protección magnetotérmica.
 - Desescarche por inyección de gas caliente.
 - Bandeja de condensados en acero inoxidable.
 - Evaporación automática de condensados.
 - Luz de cámara y cable interruptor de puerta.
 - Cable de resistencia de puerta (solo modelos BCR).
 - Cajón de evaporación en panel sándwich de 50 mm de espuma de poliuretano, revestido interiormente con chapa de acero prelacado.
 - Regulación electrónica multifunción.

Serie CR-N Equipos monoblock preparados para montaje en techo.

Serie CR-C Versión centrífuga con condensador equipado con turbina centrífuga para la conducción al exterior del aire caliente de condensación.

Esquema de instalación

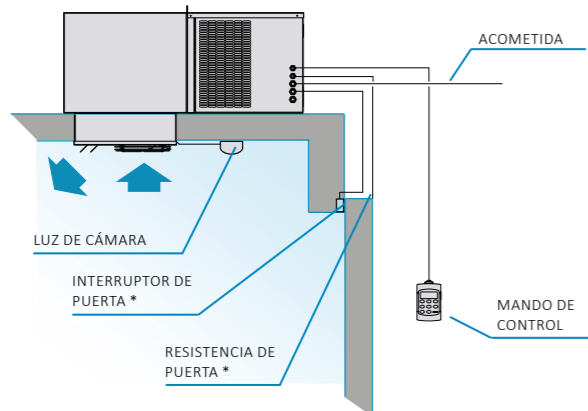

* Resistencia de puerta sólo en modelos de baja temperatura. * Interruptor de puerta no suministrado.

Equipo compacto de carga reducida de refrigerante, menor a 1,5 kg.

Diseño tropicalizado para temperatura ambiente de 45 °C.

Válvula de expansión termostática.

Desescarche por gas caliente con control de temperatura.

Equipos exentos de control de fugas.

Controlador electrónico

Los equipos intartop incorporan de serie el avanzado controlador electrónico XWING.



Mando multifunción de control digital a distancia.

Control de temperatura con registro de temperaturas máxima y mínima.

Función "Jet Cool" de enfriamiento rápido.

Modo de funcionamiento nocturno.

Versión centrífuga

Los equipos de la serie intartop centrífuga incorporan una turbina centrífuga para permitir la conducción hacia el exterior del aire caliente de descarga mediante conductos.



230 V-I-50 Hz* | Media temperatura | R134a

SERIE / MODELO AXIALES	CV	TENSIÓN	POTENCIA FRIGORÍFICA / VOLUMEN CÁMARA, SEGÚN TEMPERATURA DE CÁMARA ⁽¹⁾						POTENCIA ABSORB. NOMINAL (kW)	INTENS. MÁXIMA ABSORB. (A)	CAUDAL EVAP. (m³/h)	CARGA REFRIG. (kg)	PESO (kg)	NIVEL PRESIÓN SONORA dB(A) ⁽²⁾	PVP (€) AXIAL
			0 °C		5 °C		10 °C								
			W	m³	W	m³	W	m³							
MCR-NY-0 010	3/8	230 V-I	605	4,0	751	7,0	902	12	0,43	4,5	300	<1,0	62	30	2.021 €
MCR-NY-0 015	1/2	230 V-I	788	6,1	956	10	1134	18	0,53	5,5	300	<1,0	65	30	2.312 €
MCR-NY-1 015	1/2	230 V-I	999	8,2	1.231	12	1.490	23	0,58	5,6	600	<1,0	73	28	2.462 €
MCR-NY-1 026	3/4	230 V-I	1.265	12	1.549	19	1.853	30	0,93	9,3	600	<1,0	82	34	3.000 €
MCR-NY-1 033	1	230 V-I	1.502	16	1.817	26	2.153	41	1,05	9,5	600	<1,0	83	34	3.388 €
MCR-NY-2 033	1	230 V-I	1.911	24	2.363	37	2.846	61	1,21	10,3	1.150	<1,5	98	35	3.851 €
MCR-NY-2 053	1 1/2	230 V-I*	2.352	33	2.882	50	3.455	75	1,67	12,9	1.150	<1,5	99	39	4.562 €
MCR-NY-2 074	2	230 V-I*	2.940	40	3.560	60	4.211	90	1,83	16,9	1.150	<1,5	110	41	5.051 €

series MCR / BCR

VERSIÓN CENTRÍFUGA			
SERIE / MODELO CENTRÍFUGOS	CAUDAL COND. (m³/h)	P.E.D. ⁽³⁾ (mmca)	PVP (€) CENTRIF.
MCR-CY-0 010	375	12	2.288 €
MCR-CY-0 015	375	12	2.618 €
MCR-CY-1 015	575	12	2.788 €
MCR-CY-1 026	575	12	3.397 €
MCR-CY-1 033	575	12	3.834 €
MCR-CY-2 033	1.000	6,5	4.364 €
MCR-CY-2 053	1.000	6,5	5.170 €
MCR-CY-2 074	1.000	6,5	5.721 €

230 V-I-50 Hz* | Baja temperatura | R449A

SERIE / MODELO AXIALES	CV	TENSIÓN	POTENCIA FRIGORÍFICA / VOLUMEN CÁMARA, SEGÚN TEMPERATURA DE CÁMARA ⁽¹⁾						POTENCIA ABSORB. NOMINAL (kW)	INTENS. MÁXIMA ABSORB. (A)	CAUDAL EVAP. (m³/h)	CARGA REFRIG. (kg)	PESO (kg)	NIVEL PRESIÓN SONORA dB(A) ⁽²⁾	PVP (€) AXIAL
			-25 °C		-20 °C		-15 °C								
			W	m³	W	m³	W	m³							
BCR-NG-0 018	5/8	230 V-I	418	0,6	525	1,5	638	2,8	0,59	4,7	300	<1,0	65	33	2.601 €
BCR-NG-1 026	3/4	230 V-I	562	2,0	736	4,1	907	7,7	0,84	8,5	600	<1,0	84	38	3.032 €
BCR-NG-1 034	1 1/4	230 V-I	703	3,2	892	5,8	1.060	10	1,05	11,0	600	<1,0	84	40	3.194 €
BCR-NG-2 034	1 1/4	230 V-I	775	3,8	1.102	7,8	1.406	14	1,11	11,5	1.150	<1,5	135	41	3.628 €
BCR-NG-2 055	2,5	230 V-I*	1.630	13	2.115	23	2.655	38	2,1	25,5	1.300	<1,5	113	43	4.267 €
BCR-NG-3 096	3,5	400 V-I*	1.850	15	2.420	27	3.010	46	2,2	11,2	1.300	<1,5	147	49	5.550 €

VERSIÓN CENTRÍFUGA			
SERIE / MODELO CENTRÍFUGOS	CAUDAL COND. (m³/h)	P.E.D. ⁽³⁾ (mmca)	PVP (€) CENTRIF.
BCR-CG-0 018	375	12	2.905 €
BCR-CG-1 026	575	12	3.393 €
BCR-CG-1 034	575	12	3.562 €
BCR-CG-2 034	1.000	6,5	4.152 €
BCR-CG-2 055	1.000	12	4.809 €
BCR-CG-3 096	1.500	14	6.074 €

- Opcionales**
- Cambio a alimentación 400 V-III-50 Hz. + 5%
 - Microinterruptor de puerta. + 63 €
 - Compuerta antirretorno (equipos centrífugos). + 67 €
 - Adaptación de impulsión de aire a conducto circular. + 123 €
 - Impulsión vertical (equipos centrífugos).
 - Tratamiento anticorrosión en epoxi de la batería de evaporación. + 6%
 - Refrigerante R-452a en BT. + 2%

⁽¹⁾ Las prestaciones nominales están referidas al funcionamiento con temperatura de cámara de 0 °C (MT) y -20 °C (BT), y temperatura exterior de 35 °C. Volumen de cámara estimado según condiciones de las bases de cálculo (pág. 8).

⁽²⁾ Equipos con carga inferior a 5 toneladas de CO₂ equivalente (3,8 kg de R-134a o R-449A) exentos de comprobación de fugas (RD 552/2019).

⁽³⁾ Nivel sonoro referido a nivel de presión acústica en dB(A), medido en campo abierto a 10 m de distancia de la fuente.

⁽⁴⁾ Presión estática disponible de condensación.

* Unidades disponibles en tensión 400 V-III-50 Hz.

Dimensiones

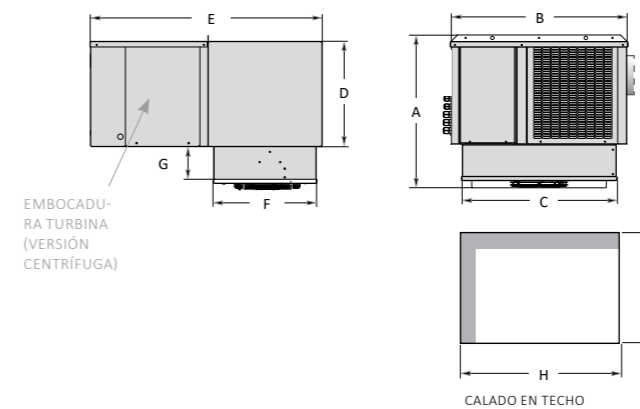

Marcos de montaje

Dimensiones (mm)	H	I
serie 0	435	380
serie 1	590	385
serie 2	760	385
serie 3	850	460

Conductos de extracción de aire

Dimensiones recomendadas para conductos de descarga en chapa, PVC, o panel de lana de vidrio, de 20 m de longitud (cada codo a 90° equivale a 5 m de longitud). Para conductos flexibles o semirrígidos se recomienda utilizar una dimensión mayor.

- serie 0: 200 x 150 mm.
- serie 1: 200 x 200 mm.
- serie 2: 250 x 150 mm.
- serie 3: 200 x 300 mm.

Dimensiones (mm)	A	B	C	D	E	F	G	H	I	Embocadura turbina
serie 0	480	600	430	330	790	375	100	435	380	185 x 115
serie 1	574	665	582	385	850	379	135	588	385	185 x 115
serie 2	677	835	756	469	850	379	135	762	385	230 x 130
serie 3	680	925	843	485	1070	454	145	762	385	236 x 266

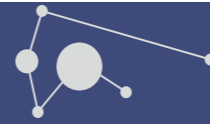

Refrigerante natural R-290 de alta eficiencia energética
 Óptimo aprovechamiento del espacio en minicámaras
 Diseño tropicalizado para ambiente de 45°C

Descripción

Equipos compactos monoblock para pequeñas cámaras frigoríficas, diseñados con refrigerante natural para instalación sobre el panel de puerta

Características

- Carga de refrigerante R290 inferior a 0,15 kg.
- Compresor hermético alternativo.
- Motoventiladores electrónicos EC
- Presostato de alta presión.
- Expansión por válvula termostática.
- Protección magnetotérmica.
- Desescarche por inyección de gas caliente.
- Bandeja de condensados en acero inoxidable.
- Evaporación automática de condensados.
- Luz led de cámara con microinterruptor de puerta.
- Tampón aislante desmontable
- Cable de resistencia de puerta (solo modelos BCP).
- Regulación electrónica multifunción.

Esquema de instalación con cortina de aire (opcional)

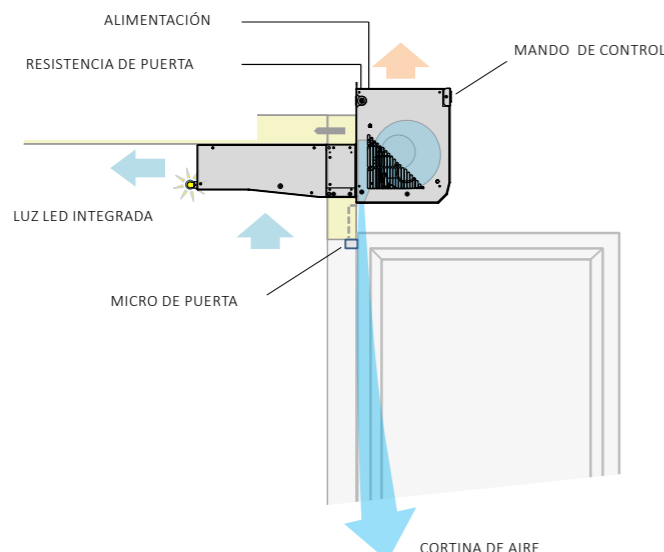

Cortina de aire (opcional)

Los equipos de puerta pueden incorporar de manera opcional una cortina de aire integrada en la propia unidad, especialmente dimensionada para puertas de 1800 mm de alto y hasta 800 mm de luz. Cuenta con un ventilador centrífugo de velocidad regulable, interruptor de puerta y difusor lineal.

La cortina de aire crea una barrera invisible para evitar las pérdidas de frío del interior de la cámara, que se activa durante la apertura de la puerta, y evita la entrada de aire caliente y la pérdida de aire frío, con una eficiencia superior al 50%.

Ventilador centrífugo.
 Difusor de aire longitudinal.
 Activación automática con apertura de puerta.

Controlador electrónico

La regulación electrónica de serie en nuestros equipos compactos comerciales de puerta, es un avanzado controlador de reducido tamaño, que incluye las siguientes funciones:



Control de temperatura con registro de temperaturas máxima y mínima.
 Función "Jet Cool" de enfriamiento rápido.
 Función Energy saving

Luz led de cámara integrada

Luz led de cámara de gran eficiencia, integrada en el equipo, que se activa automáticamente al abrirse la puerta de la cámara.

230 V-I-50 Hz | Media temperatura | R-290

Serie / Modelo	Compresor		Potencia frigorífica / Volumen cámara, según temperatura de cámara ⁽¹⁾						Potencia absorb. nominal (kW)	Intens. máxima absorb. (A)	Caudal evap. (m³/h)	Carga refrig. (kg) ⁽²⁾	Peso (kg)	Nivel presión sonora dB(A) ⁽³⁾	PVP (€)
	CV	Tensión	0 °C		5 °C		10 °C								
			W	m³	W	m³	W	m³							
R-290 MCP-ND-0 009	1/3	230 V-I	700	6	810	8	945	13	0,34	3,1	275	< 0,1	61	29	2.293 €
MCP-ND-1 012	1/2	230 V-I	1.065	9	1.235	15	1.430	27	0,52	4,3	550	< 0,1	67	29	2.777 €
MCP-ND-1 017	3/4	230 V-I	1.325	14	1.530	20	1.765	35	0,72	4,5	550	< 0,1	67	31	3.140 €

230 V-I-50 Hz | Baja temperatura | R-290

Serie / Modelo	Compresor		Potencia frigorífica / Volumen cámara, según temperatura de cámara ⁽¹⁾						Potencia absorb. nominal (kW)	Intens. máxima absorb. (A)	Caudal evap. (m³/h)	Carga refrig. (kg) ⁽²⁾	Peso (kg)	Nivel presión sonora dB(A) ⁽³⁾	PVP (€)
	CV	Tensión	-25 °C		-20 °C		-15 °C								
			W	m³	W	m³	W	m³							
R-290 BCP-ND-0 014	3/4	230 V-I	420	1	500	2,5	590	5	0,30	3,3	275	< 0,1	62	29	2.669 €
BCP-ND-1 017	3/4	230 V-I	575	2	695	6	825	9	0,34	4,3	550	< 0,1	67	29	3.019 €
BCP-ND-1 028	1 1/4	230 V-I	750	4	905	9	1.070	15	0,64	6,0	550	< 0,1	74	31	3.407 €

Opcionales

- Tratamiento anticorrosión en epoxi de la batería + 6%
- Refrigerante R-452A en BT. + 2%

Dimensiones

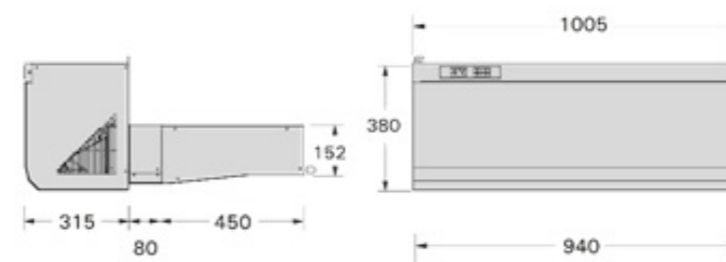

Dimensiones (mm)	A	B	C	D	E	F	G
serie 0	1.005	152	380	315	450	80	940
serie 1	1.005	152	380	315	450	80	940

⁽¹⁾ Las prestaciones nominales están referidas al funcionamiento con temperaturas de cámara de 0 °C (MT) o -20 °C (BT), y temperatura exterior de 35 °C. Volumen de cámara recomendado para cámaras con suelo y aislamiento de 80 mm en MT o 100 mm en BT, densidad de mercancía de 250 kg/m³ con una rotación diaria del 10% a una temperatura de entrada de 25 °C en MT y -15 °C en BT.

⁽²⁾ Equipos con carga inferior a 5 toneladas de CO₂ equivalente (3,8 kg de R-134a o R-449A) exentos de comprobación de fugas (RD 552/2019).

⁽³⁾ Nivel sonoro máximo referido a nivel de presión acústica en dB(A), medido en campo abierto a 10 m de distancia de la fuente.

Marcos de montaje

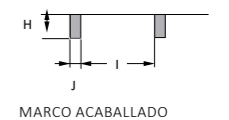

Dimensiones (mm)	H	I	J
serie 0	185	828	58
serie 1	185	828	58



Descripción

Equipos compactos monoblock para minicámaras frigoríficas de refrigeración y congelación, para montaje acaballado sobre el panel de puerta de la cámara con opcional de cortina de aire integrada en el equipo.

Características

- Alimentación 230 V-I-50 Hz.
- Carga de refrigerante R-134a o R-449A, inferior a 1 kg.
- Compresor hermético alternativo.
- Presostatos de alta y baja presión.
- Expansión por válvula termostática.
- Protección magnetotérmica.
- Desescarche por inyección de gas caliente.
- Bandeja de condensados en acero inoxidable.
- Evaporación automática de condensados.
- Luz led de cámara con microinterruptor de puerta.
- Cable de resistencia de puerta (solo modelos BCP).
- Regulación electrónica multifunción.

Esquema de instalación con cortina de aire (opcional)

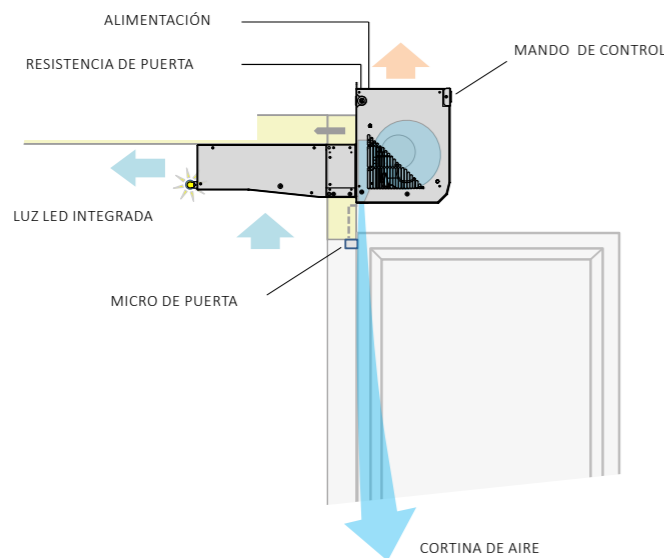

Equipo compacto de carga reducida de refrigerante, menor a 1 kg.

Diseño tropicalizado para temperatura ambiente de 45 °C.

Cortina de aire (opcional).

Desescarche por gas caliente con control de temperatura.

Equipos exentos de control de fugas.

Cortina de aire (opcional)

Los equipos de puerta pueden incorporar de manera opcional una cortina de aire integrada en la propia unidad, especialmente dimensionada para puertas de 1800 mm de alto y hasta 800 mm de luz. Cuenta con un ventilador centrífugo de velocidad regulable, interruptor de puerta y difusor lineal.

La cortina de aire crea una barrera invisible para evitar las pérdidas de frío del interior de la cámara, que se activa durante la apertura de la puerta, y evita la entrada de aire caliente y la pérdida de aire frío, con una eficiencia superior al 50%.

Ventilador centrífugo.

Difusor de aire longitudinal.

Activación automática con apertura de puerta.

Controlador electrónico

La regulación electrónica XW60LH, de serie en nuestros equipos compactos comerciales de puerta, es un avanzado controlador de reducido tamaño, que incluye las siguientes funciones:



Control de temperatura con registro de temperaturas máxima y mínima.

Función "Jet Cool" de enfriamiento rápido.

Modo de funcionamiento nocturno.

4 relés de salida para: compresor, ventilador, desescarche y luz.

3 sondas NTC de temperatura para cámara, desescarche y condensación.

Luz led de cámara integrada

Luz led de cámara de gran eficiencia, integrada en el equipo, que se activa automáticamente al abrirse la puerta de la cámara.

230 V-I-50 Hz | Media temperatura | R-134a

Serie / Modelo	Compresor		Potencia frigorífica / Volumen cámara, según temperatura de cámara ⁽¹⁾						Potencia absorb. nominal (kW)	Intens. máxima absorb. (A)	Caudal evap. (m ³ /h)	Carga refrig. (kg) ⁽²⁾	Peso (kg)	Nivel presión sonora dB(A) ⁽³⁾	PVP (€)	PVP con cortina (€)
	CV	Tensión	0 °C		5 °C		10 °C									
			W	m ³	W	m ³	W	m ³								
MCP-NY-0 010	3/8	230 V-I	580	4	695	7	820	12	0,47	4,57	300	<1,0	61	29	2.121 €	2.728 €
MCP-NY-0 015	1/2	230 V-I	760	7	890	10	1 030	15	0,61	5,57	300	<1,0	66	29	2.390 €	2.997 €
MCP-NY-1 015	1/2	230 V-I	880	8	1 055	12	1 250	21	0,68	5,84	600	<1,0	72	29	2.642 €	3.249 €
MCP-NY-1 026	3/4	230 V-I	1 180	11	1 435	18	1 710	28	0,91	9,54	600	<1,0	79	29	3.018 €	3.625 €
MCP-NY-1 033	1	230 V-I	1 490	17	1 760	26	2 070	40	1,03	9,68	600	<1,0	83	29	3.390 €	3.997 €

230 V-I-50 Hz | Baja temperatura | R-449A

Serie / Modelo	Compresor		Potencia frigorífica / Volumen cámara, según temperatura de cámara ⁽¹⁾						Potencia absorb. nominal (kW)	Intens. máxima absorb. (A)	Caudal evap. (m ³ /h)	Carga refrig. (kg) ⁽²⁾	Peso (kg)	Nivel presión sonora dB(A) ⁽³⁾	PVP (€)	PVP con cortina (€)
	CV	Tensión	-25 °C		-20 °C		-15 °C									
			W	m ³	W	m ³	W	m ³								
BCP-NG-0 018	5/8	230 V-I	390	1	490	2	585	3	0,67	7,17	300	<1,0	67	29	2.712 €	3.319 €
BCP-NG-1 026	3/4	230 V-I	640	3	810	7	960	10	1,00	8,64	600	<1,0	74	31	3.166 €	3.773 €
BCP-NG-1 034	1 1/4	230 V-I	790	4	950	10	1 120	12	1,27	11,08	600	<1,0	80	29	3.363 €	3.970 €

Opcionales

- Tratamiento anticorrosión en epoxi de la batería + 6%
- Refrigerante R-452A en BT. + 2%

Dimensiones

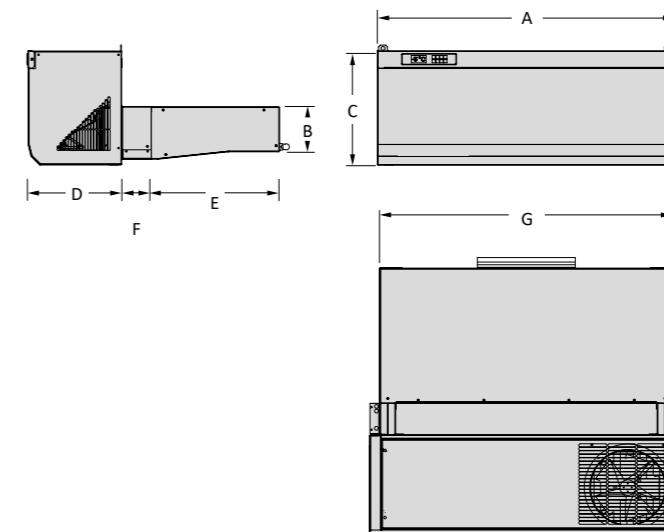

Dimensiones (mm)	A	B	C	D	E	F	G
serie 0	1 005	152	380	315	450	80	940
serie 1	1 005	152	380	315	450	80	940

⁽¹⁾ Las prestaciones nominales están referidas al funcionamiento con temperaturas de cámara de 0 °C (MT) o -20 °C (BT), y temperatura exterior de 35 °C. Volumen de cámara recomendado para cámaras con suelo y aislamiento de 80 mm en MT o 100 mm en BT, densidad de mercancía de 250 kg/m³ con una rotación diaria del 10% a una temperatura de entrada de 25 °C en MT y -15 °C en BT.

⁽²⁾ Equipos con carga inferior a 5 toneladas de CO₂ equivalente (3,8 kg de R-134a o R-449A) exentos de comprobación de fugas (RD 552/2019).

⁽³⁾ Nivel sonoro máximo referido a nivel de presión acústica en dB(A), medido en campo abierto a 10 m de distancia de la fuente.

Marcos de montaje

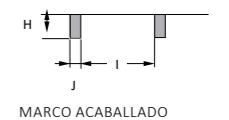

Dimensiones (mm)	H	I	J
serie 0	185	828	58
serie 1	185	828	58

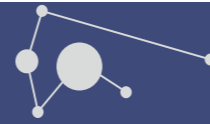

Equipos certificados en fábrica sin necesidad de ensayos in situ.

(Reglamento Seguridad de Instalaciones Frigoríficas)

Diseño tropicalizado para temperatura ambiente de 45°C.

Válvula de expansión termostática.

Precarga de refrigerante incluida.

Equipos exentos de control de fugas

Controlador electrónico

Los equipos intarsplit incorporan de serie el avanzado controlador electrónico XWING.



Mando multifunción de control digital a distancia.

Control de temperatura con registro de temperaturas máxima y mínima.

Función de enfriamiento rápido y modo nocturno.

Control de condensación digital

De serie en toda la gama intarsplit, protege al equipo frente a bajas temperaturas exteriores ocasionales. Para funcionamientos prolongados con baja temperatura exterior se recomienda instalar el control de condensación proporcional (opcional en series 3 y 33 en adelante).

Resistencia de cárter (opcional)

Se recomienda la inclusión de la resistencia de cárter opcional en todos los equipos instalados en el exterior.

Versión centrífuga

Los equipos de la serie intarsplit centrífuga incorporan una turbina centrífuga que permite la conducción al exterior del aire caliente de condensación mediante conductos de aire.



Interconexiones eléctricas

Los equipos intarsplit incluyen de serie interconexiones eléctricas de 10 m de longitud (excepto serie 4 y 40 a 54).

Tensión	230 V-I-50 Hz	400 V-III-50 Hz
Sondas	4 x 1 mm ²	
Maniobra	2 x 1 mm ²	3 x 1 mm ²
Desescarche	2 x 1,5 mm ² + T	4 x 1,5 mm ² + T
Termostato	2 x 1 mm ²	
Interr. puerta*	2 x 1 mm ² (+ 2 x 1 mm ² en BT)	
Luz cámara *	2 x 1 mm ² + T	

* opcional no incluido

We reserve the right to change specifications without prior notice.

Descripción Equipos semicompactos para cámaras frigoríficas de pequeño y mediano tamaño, formados por una unidad condensadora horizontal y una unidad evaporadora de bajo perfil, doble flujo o de tipo cúbico.

- Características
- Alimentación 230 V-I-50 Hz o 400 V-III-50 Hz.
 - Carga reducida de refrigerante R-134a o R-449A.
 - Compresor hermético alternativo (con aislamiento acústico en modelos trifásicos).
 - Presostatos de alta y baja presión.
 - Recipiente de líquido.
 - Precarga de refrigerante para hasta 10 m de tubería.
 - Expansión por válvula termostática.
 - Desescarche por resistencia eléctrica (excepto serie ASH).
 - Bandeja de condensados en acero inoxidable.
 - Conexiones de tipo Flare (hasta 3/8"-3/4") y válvulas de servicio.
 - Interconexión eléctrica de 10 m incluida (excepto serie 4 y 40 a 54).
 - Protección magnetotérmica de motores.
 - Regulación electrónica multifunción con mando a distancia y control de condensación digital.
 - Inyección de líquido en equipos de baja temperatura con R-449A.

Serie SH-N Unidad condensadora axial y unidad evaporadora de bajo perfil.

Serie SH-Q Unidad condensadora axial y unidad evaporadora de tipo cúbico.

Serie SH-C Unidad condensadora centrífuga y unidad evaporadora de bajo perfil.

Serie SH-CQ Unidad condensadora centrífuga y unidad evaporadora de tipo cúbico.

Serie SH-D Unidad condensadora axial y unidad evaporadora de doble flujo.

Serie SH-CD Unidad condensadora centrífuga y unidad evaporadora de doble flujo.

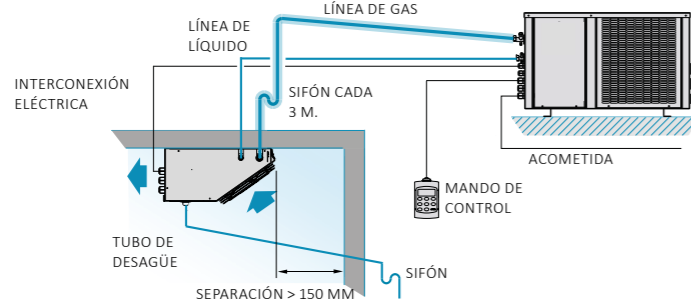

Distancia vertical máxima entre unidades de 15 m en caso de que la unidad condensadora esté situada a mayor altura que la unidad evaporadora, y de 6 m en caso contrario.

*Pendiente mínima del tubo de desagüe del 20% para modelos de baja temperatura.

Características técnicas y constructivas sujetas a variación sin previo aviso.

230 V-I-50 Hz* / 400 V-III-50 Hz | Media temperatura | R134a / R449A

VERSIÓN AXIAL	COMPRESOR		POTENCIA FRIGORÍFICA / VOLUMEN CÁMARA, SEGÚN TEMPERATURA DE CÁMARA (2)						POTENCIA ABSORB. NOMINAL (kW)	INTENS. MÁXIMA ABSORB. (A)	CAUDAL EVAP. (m ³ /h)	CONEXIÓN FRIGORÍFICA LIQ.- GAS	CARGA REFRIG. (kg)	PESO (kg)	NIVEL PRESIÓN SONORA dB(A) (2)	PVP (€) AXIAL
			0°C		5°C		10°C									
			W	m ³	W	m ³	W	m ³								
MSH-NY-00 010	3/8	230 V-I	643	5,1	788	8,5	945	13	0,46	4,6	300	1/4"-3/8"	< 2,5	37+12	31	2.575 €
MSH-NY-00 015	1/2	230 V-I	832	7,2	1 010	10	1 193	19	0,56	5,6	300	1/4"-3/8"	< 2,5	40+12	29	2.790 €
MSH-NY-11 015	1/2	230 V-I	988	8,2	1 220	12	1 474	23	0,58	5,6	550	1/4"-1/2"	< 2,5	41+16	30	2.949 €
MSH-NY-11 026	3/4	230 V-I	1 250	12	1 533	18	1 827	30	0,82	9,3	550	1/4"-1/2"	< 2,5	48+16	34	3.809 €
MSH-NY-11 033	1	230 V-I	1 481	16	1 790	24	2 116	41	0,93	9,5	550	1/4"-1/2"	< 2,5	50+16	34	4.099 €
MSH-NY-22 033	1	230 V-I	1 922	23	2 368	36	2 846	60	1,06	10,0	1 050	1/4"-5/8"	< 2,5	53+24	35	4.572 €
MSH-NY-22 053	1 1/2	230 V-I *	2 363	31	2 882	48	3 455	73	1,45	12,6	1 050	1/4"-5/8"	< 2,5	63+24	39	5.068 €
MSH-NY-33 053	1 1/2	230 V-I *	2 688	40	3 318	63	4 069	100	1,55	13,2	1 725	1/4"-3/4"	< 10,0	82+45	39	5.298 €
MSH-NY-33 074	2	230 V-I *	3 518	47	4 347	71	5 198	110	1,93	17,2	1 725	1/4"-3/4"	< 10,0	84+45	39	5.708 €
MSH-NY-43 086	4	400 V-III	4 379	66	5 366	100	6 421	165	2,39	14,9	1 725	3/8"-7/8"	< 10,0	107+55	49	6.785 €
MSH-NY-44 108	5	400 V-III	5 628	88	6 888	140	8 274	220	3,05	19,2	3 100	3/8"-7/8"	< 10,0	109+55	50	7.528 €
MSH-NY-44 136	6 1/2	400 V-III	6 862	115	8 311	170	9 881	260	3,77	23,2	3 100	3/8"-1 1/8"	< 10,0	112+55	50	9.414 €
MSH-NG-0 008	1/3	230 V-I	758	5,1	900	8,5	1 071	13	0,47	5,1	300	1/4"-3/8"	< 2,5	38+12	32	2.428 €
MSH-NG-0 010	3/8	230 V-I	893	6,1	1 042	10	1 223	15	0,58	4,8	300	1/4"-3/8"	< 2,5	40+12	30	2.629 €
MSH-NG-0 012	1/2	230 V-I	980	7,2	1 135	12	1 324	19	0,65	5,6	300	1/4"-3/8"	< 2,5	41+12	32	2.780 €
MSH-NG-1 014	1/2	230 V-I	1 100	10	1 313	16	1 564	26	0,79	6,7	550	1/4"-1/2"	< 2,5	44+16	32	3.117 €
MSH-NG-1 016	5/8	230 V-I	1 216	12	1 451	18	1 734	30	0,85	7,6	550	1/4"-1/2"	< 2,5	53+16	34	3.321 €
MSH-NG-1 018	3/4	230 V-I	1 404	14	1 653	22	1 954	35	1,00	8,9	550	1/4"-1/2"	< 2,5	54+16	35	3.593 €
MSH-NG-1 024	1	230 V-I	1 528	16	1 811	24	2 140	41	1,01	11,1	550	1/4"-1/2"	< 2,5	54+16	35	3.863 €
MSH-NG-2 024	1	230 V-I	2 020	23	2 424	36	2 896	60	1,27	11,6	1 050	3/8"-5/8"	< 2,5	65+24	36	4.310 €
MSH-NG-2 026	1 1/4	230 V-I *	2 230	26	2 640	41	3 131	64	1,36	12,0	1 050	3/8"-5/8"	< 2,5	66+24	38	4.512 €
MSH-NG-2 034	1 1/2	230 V-I *	2 543	31	2 985	48	3 516	73	1,80	16,6	1 050	3/8"-5/8"	< 2,5	66+24	40	4.716 €
MSH-NG-3 034	1 1/2	230 V-I *	3 091	40	3 674	63	4 364	100	1,67	17,0	1 725	3/8"-5/8"	< 10,0	74+45	39	4.945 €
MSH-NG-3 038	1 3/4	400 V-III	3 459	47	4 060	71	4 786	110	1,53	7,8	1 725	3/8"-5/8"	< 10,0	71+45	40	5.382 €
MSH-NG-4 048	2	400 V-III	4 494	66	5 350	98	6 358	155	2,61	10,5	1 725	3/8"-3/4"	< 10,0	95+45	41	6.243 €
MSH-NG-4 054	2 1/4	400 V-III	4 949	74	5 847	110	6 916	170	2,80	11,0	1 725	3/8"-3/4"	< 10,0	96+45	41	6.673 €

230 V-I-50 Hz* / 400 V-III-50 Hz | Baja temperatura | R449A

VERSIÓN AXIAL	COMPRESOR		POTENCIA FRIGORÍFICA / VOLUMEN CÁMARA, SEGÚN TEMPERATURA DE CÁMARA (2)						POTENCIA ABSORB. NOMINAL (kW)	INTENS. MÁXIMA ABSORB. (A)	CAUDAL EVAP. (m ³ /h)	CONEXIÓN FRIGORÍFICA LIQ.- GAS	CARGA REFRIG. (kg)	PESO (kg)	NIVEL PRESIÓN SONORA dB(A) (2)	PVP (€) AXIAL
			-25°C		-20°C		-15°C									
			W	m ³	W	m ³	W	m ³								
BSH-NG-0 018	5/8	230 V-I	422	0,9	537	1,8	658	3,9	0,60	4,8	300	1/4"-1/2"	< 2,5	41+12	33	3.060 €
BSH-NG-1 026	3/4	230 V-I	559	2,1	711	4,2	900	7,3	0,84	8,7	550	1/4"-1/2"	< 2,5	55+16	38	3.263 €
BSH-NG-1 034	1 1/4	230 V-I	622	3,0	858	5,9	1 038	10	1,05	11,2	550	1/4"-1/2"	< 2,5	56+16	40	3.633 €
BSH-NG-2 034	1 1/4	230 V-I	815	4,0	1 056	8,0	1 377	14	1,18	11,5	1 050	3/8"-5/8"	< 2,5	66+24	41	3.993 €
BSH-NG-2 055	1 3/4	230 V-I *	1 175	8	1 675	16	2 090	28	1,7	17,5	1 050	1/4"-5/8"	< 2,5	61+24	37	4.765 €
BSH-NG-2 075	2	230 V-I *	1 620	13	2 035	21	2 435	34	2,1	25,5	1 050	1/4"-5/8"	< 3,5	66+24	40	5.519 €
BSH-NG-3 075	2	230 V-I *	1 795	15	2 410	26	3 020	46	2,3	26,3	1 725	1/4"-5/8"	< 3,5	85+43	40	5.772 €
BSH-NG-3 096	3 1/2	400 V-III	2 046	23	2 745	37	3 435	62	2,18	12,4	1 725	3/8"-3/4"	< 10,0	85+45	50	6.037 €
BSH-NG-4 108	4 1/4	400 V-III	2 851	34	3 588	55	4 378	94	3,18	15,5	1 725	3/8"-7/8"	< 10,0	107+45	51	7.998 €
BSH-NG-4 136	5	400 V-III	3 289	42	4 064	67	4 895	110	4,37	17,4	1 725	3/8"-7/8"	< 10,0	107+45	46	8.937 €

Opcionales

- Cambio a alimentación 400 V-III-50 Hz. * + 5%
- Resistencia de cárter. + 75 €
- Control de condensación proporcional:
 - versión axial (N): series 3/33 y 4/43/44 + 304 €
 - versión centrífuga (C): series 4/43/44 + 486 €
- Ventiladores electrónicos en el evaporador. + 6%
- Impulsión vertical (equipos centrífugos).
- Refrigerante R452A. + 0%
- Otros refrigerantes. Consultar

Dimensiones

Evaporador

Dimensiones

Condensador

EMBOCADURA TURBINA (VERSIÓN CENTRÍFUGA)

Características técnicas y constructivas sujetas a variación sin previo aviso.

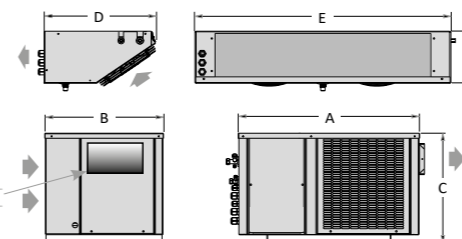

Dimensiones (mm)	A	B	C	D	E	F	Ventiladores evaporador	Embocadura turbina
series 0 y 00	600	395	355	407	520	150	1x Ø 172	185 x 115
series 1 y 11	665	435	416	418	600	200	1x Ø 200	185 x 115
series 2 y 22	835	435	500	418	950	200	2x Ø 200	230 x 130
series 3 y 33	925	580	515	510	1 650	200	3x Ø 254	236 x 266
series 4 y 43	1 000	615	585	510	1 650	200	3x Ø 254	305 x 266
serie 44	1 000	615	585	550	2 020	260	4x Ø 300	305 x 266

We reserve the right to change specifications without prior notice.



230 V-I-50 Hz* / 400 V-III-50 Hz | Media temperatura | R134a / R449A

SERIE / MODELO AXIALES	CV	TENSIÓN	POTENCIA FRIGORÍFICA / VOLUMEN CÁMARA, SEGÚN TEMPERATURA DE CÁMARA ⁽¹⁾						POTENCIA ABSORB. NOMINAL (kW)	INTENS. MÁXIMA ABSORB. (A)	CAUDAL EVAP. (m³/h)	CONEXIÓN FRIGORÍFICA LIQ.-GAS	CARGA REFRIG. (kg)	PESO (kg)	NIVEL PRESIÓN SONORA dB(A) ⁽²⁾	PVP (€) AXIAL
			0°C		5°C		10°C									
			W	m³	W	m³	W	m³								
MSH-QY-30 068	3 1/2	400 V-III	3 854	54	4 646	59	5 513	84	2,00	12,0	2 100	1/4"-3/4"	< 10,0	74+43	48	6.038 €
MSH-QY-40 086	4	400 V-III	4 431	63	5 418	68	6 500	100	2,35	14,3	2 100	3/8"-7/8"	< 10,0	107+43	49	7.058 €
MSH-QY-41 108	5	400 V-III	5 324	71	6 500	80	7 775	110	2,77	17,3	2 700	3/8"-7/8"	< 10,0	109+56	50	7.839 €
MSH-QY-42 136	6 1/2	400 V-III	7 235	110	8 773	180	10 474	280	3,85	22,0	4 150	3/8"-1 1/8"	< 10,0	112+72	50	9.798 €
MSH-QY-53 171	8	400 V-III	7 830	135	9 535	185	11 520	300	4,25	24,1	5 200	3/8"-1 1/8"	< 10,0	162+89	50	11.362 €
MSH-QY-53 215	10	400 V-III	9 450	175	11 435	230	13 740	350	5,01	30,5	6 200	3/8"-1 1/8"	< 10,0	166+94	49	12.497 €
MSH-QY-54 271	13	400 V-III	12 400	240	14 760	320	17 420	400	7,13	40,2	8 300	1/2"-1 3/8"	< 10,0	171+118	48	14.628 €
MSH-QG-30 034	3 1/2	230 V-I*	3 409	39	4 054	62	4 797	99	1,61	16,3	2 100	3/8"-5/8"	< 10,0	74+43	39	5.182 €
MSH-QG-30 038	1 3/4	400 V-III	3 647	46	4 301	70	5 063	110	1,79	7,1	2 100	3/8"-5/8"	< 10,0	71+43	40	5.449 €
MSH-QG-40 048	2	400 V-III	4 752	67	5 559	99	6 554	159	2,42	9,8	2 100	3/8"-3/4"	< 10,0	95+43	41	6.373 €
MSH-QG-40 054	2 1/4	400 V-III	5 203	76	6 060	113	7 106	178	2,61	10,3	2 100	3/8"-3/4"	< 10,0	96+43	41	6.795 €
MSH-QG-41 060	3	400 V-III	6 049	86	7 038	128	8 260	198	3,07	11,3	2 700	1/2"-3/4"	< 10,0	97+56	38	7.364 €
MSH-QG-41 068	3 1/2	400 V-III	6 545	113	7 581	163	8 866	253	3,44	12,3	2 700	1/2"-3/4"	< 10,0	98+56	39	8.848 €
MSH-QG-52 086	4	400 V-III	8 056	125	9 542	185	11 320	315	3,87	15,0	4 150	1/2"-7/8"	< 10,0	135+72	49	10.536 €
MSH-QG-52 108	5	400 V-III	9 386	160	11 011	220	12 991	375	4,90	18,0	4 150	1/2"-7/8"	< 10,0	157+72	47	10.981 €
MSH-QG-53 136	6 1/2	400 V-III	11 894	190	13 856	260	16 173	430	6,67	21,0	6 200	1/2"-1 1/8"	< 10,0	140+94	46	11.881 €

230 V-I-50 Hz* / 400 V-III-50 Hz | Baja temperatura | R449A

SERIE / MODELO AXIALES	CV	TENSIÓN	POTENCIA FRIGORÍFICA / VOLUMEN CÁMARA, SEGÚN TEMPERATURA DE CÁMARA ⁽¹⁾						POTENCIA ABSORB. NOMINAL (kW)	INTENS. MÁXIMA ABSORB. (A)	CAUDAL EVAP. (m³/h)	CONEXIÓN FRIGORÍFICA LIQ.-GAS	CARGA REFRIG. (kg)	PESO (kg)	NIVEL PRESIÓN SONORA dB(A) ⁽²⁾	PVP (€) AXIAL
			-25°C		-20°C		-15°C									
			W	m³	W	m³	W	m³								
BSH-QG-30 075	2	230 V-I*	1 765	14	2 425	27	3 050	47	2,3	25,1	2 100	1/4"-5/8"	< 3,5	85+43	40	5.767 €
BSH-QG-30 096	3 1/2	400 V-III	2 354	22	2 925	36	3 533	61	2,34	11,2	2 100	3/8"-3/4"	< 10,0	85+43	50	6.412 €
BSH-QG-41 108	4 1/4	400 V-III	2 988	34	3 799	58	4 656	99	2,94	14,4	2 700	3/8"-7/8"	< 10,0	107+56	51	8.356 €
BSH-QG-42 136	5	400 V-III	4 205	51	5 119	85	6 092	144	4,16	17,3	4 150	3/8"-7/8"	< 10,0	107+72	46	9.973 €
BSH-QG-53 215	7 1/2	400 V-III	5 692	80	7 300	120	8 976	200	6,08	25,0	5 200	1/2"-1 1/8"	< 10,0	166+89	49	13.049 €
BSH-QG-53 271	10	400 V-III	7 329	110	9 048	150	10 877	220	7,71	30,0	6 200	1/2"-1 1/8"	< 10,0	166+94	49	13.749 €

series MSH / BSH

VERSIÓN CENTRÍFUGA			
SERIE / MODELO CENTRÍFUGOS	CAUDAL COND. (m³/h)	P.E.D. ⁽³⁾ (mmca)	PVP (€) CENTRIF.
MSH-CQY-30 068	1 500	14	6.699 €
MSH-CQY-40 086	3 500	10	7.832 €
MSH-CQY-41 108	3 500	10	8.701 €
MSH-CQY-42 136	3 500	10	10.876 €
MSH-CQY-53 171	3 600	10	12.523 €
MSH-CQY-53 215	3 600	10	13.737 €
MSH-CQY-54 271	3 600	10	16.163 €
MSH-CQG-30 034	1 500	14	5.678 €
MSH-CQG-30 038	1 500	14	5.962 €
MSH-CQG-40 048	3 500	10	6.895 €
MSH-CQG-40 054	3 500	10	7.324 €
MSH-CQG-41 060	3 500	10	7.900 €
MSH-CQG-41 068	3 500	10	9.407 €
MSH-CQG-52 086	3 600	10	11.102 €
MSH-CQG-52 108	3 600	10	11.548 €
MSH-CQG-53 136	3 600	10	12.446 €

VERSIÓN CENTRÍFUGA			
SERIE / MODELO CENTRÍFUGOS	CAUDAL COND. (m³/h)	P.E.D. ⁽³⁾ (mmca)	PVP (€) CENTRIF.
BSH-CQG-30 075	1 500	14	6.091 €
BSH-CQG-30 096	1 500	14	7.002 €
BSH-CQG-41 108	3 500	10	8.932 €
BSH-CQG-42 136	3 500	10	10.574 €
BSH-CQG-53 215	3 600	10	13.651 €
BSH-CQG-53 271	3 600	10	14.349 €

230 V-I-50 Hz* / 400 V-III-50 Hz | Alta temperatura | R134a / R449A

SERIE / MODELO AXIALES	CV	TENSIÓN	POTENCIA FRIGORÍFICA / VOLUMEN CÁMARA, SEGÚN TEMPERATURA DE CÁMARA ⁽¹⁾						POTENCIA ABSORB. NOMINAL (kW)	INTENS. MÁXIMA ABSORB. (A)	CAUDAL EVAP. (m³/h)	CONEXIÓN FRIGORÍFICA LIQ.-GAS	CARGA REFRIG. (kg)	PESO (kg)	NIVEL PRESIÓN SONORA dB(A) ⁽²⁾	PVP (€) AXIAL
			9°C		12°C		15°C									
			W	m³	W	m³	W	m³								
ASH-DY-11 015	1/2	230 V-I	1 555	14	1 733	19	1 928	26	0,75	5,9	1 100	1/4"-1/2"	< 2,5	48+32	27	3.851 €
ASH-DY-11 026	3/4	230 V-I	1 985	18	2 221	24	2 462	33	0,99	9,6	1 100	1/4"-1/2"	< 2,5	51+32	33	4.163 €
ASH-DY-11 033	1	230 V-I	2 378	22	2 636	29	2 903	40	1,37	9,8	1 100	1/4"-5/8"	< 2,5	51+32	34	4.672 €
ASH-DY-22 033	1	230 V-I	2 961	28	3 329	38	3 717	51	1,30	10,7	1 800	1/4"-5/8"	< 2,5	54+45	34	5.129 €
ASH-DY-22 053	1 1/2	230 V-I*	3 738	35	4 169	48	4 625	63	2,04	13,3	1 800	3/8"-3/4"	< 10,0	55+45	39	5.968 €
ASH-DY-33 053	1 1/2	230 V-I*	4 211	42	4 709	56	5 234	76	2,05	13,6	3 150	3/8"-3/4"	< 10,0	74+65	39	6.318 €
ASH-DY-33 074	2	230 V-I*	5 502	58	6 148	77	6 830	104	2,74	17,6	3 150	3/8"-3/4"	< 10,0	71+65	39	7.520 €
ASH-DY-43 086	4	400 V-III	7 124	74	8 001	98	8 915	131	3,16	15,4	3 150	3/8"-7/8"	< 10,0	107+65	41	8.568 €
ASH-DY-43 108	5	400 V-III	8 216	85	9 177	111	10 206	148	3,76	18,4	3 150	3/8"-7/8"	< 10,0	109+65	43	9.404 €
ASH-DY-44 108	5	400 V-III	8 873	92	9 954	121	11 062	160	4,08	18,4	5 700	3/8"-7/8"	< 10,0	112+70	43	10.306 €
ASH-DY-44 136	6 1/2	400 V-III	10 988	114	12 206	148	13 498	195	4,57	22,4	5 700	1/2"-1 1/8"	< 10,0	112+70	45	11.336 €
ASH-DG-1 010	3/8	230 V-I	1 237	10	1 341	14	1 455	19	0,77	5,2	1 100	1/4"-3/8"	< 2,5	42+32	32	3.530 €
ASH-DG-1 012	1/2	230 V-I	1 419	12	1 535	16	1 664	22	0,82	6,2	1 100	1/4"-3/8"	< 2,5	43+32	28	3.680 €
ASH-DG-2 014	1/2	230 V-I	1 829	16	1 965	22	2 109	29	0,95	7,4	1 100	1/4"-1/2"	< 2,5	35+32	32	3.831 €
ASH-DG-2 016	5/8	230 V-I	2 014	18	2 169	24	2 338	33	1,03	8,3	1 100	1/4"-1/2"	< 2,5	54+32	34	3.981 €
ASH-DG-2 018	3/4	230 V-I	2 309	22	2 481	28	2 675	38	1,23	9,6	1 100	1/4"-1/2"	< 2,5	55+32	35	4.206 €
ASH-DG-2 024	1	230 V-I	2 988	27	3 228	36	3 480	47	1,61	11,8	1 800	3/8"-5/8"	< 10,0	55+45	36	4.730 €
ASH-DG-3 026	1 1/4	230 V-I*	3 434	33	3 709	42	3 996	57	1,76	11,7	1 800	3/8"-5/8"	< 10,0	74+45	38	5.074 €
ASH-DG-3 034	1 1/2	230 V-I*	4 376	41	4 692	54	5 048	72	2,26	16,5	1 800	3/8"-5/8"	< 10,0	74+45	41	5.706 €
ASH-DG-3 038	1 3/4	400 V-III	5 011	47	5 356	62	5 733	85	2,15	7,3	1 800	3/8"-5/8"	< 10,0	71+45	40	6.615 €
ASH-DG-4 048	2	400 V-III	6 667	66	7 151	86	7 673	115	2,98	10,2	3 150	1/2"-3/4"	< 10,0	95+65	41	7.294 €
ASH-DG-4 054	2 1/4	400 V-III	7 362	73	7 875	95	8 446	125	3,23	10,7	3 150	1/2"-3/4"	< 10,0	96+65	41	7.740 €
ASH-DG-4 060	3	400 V-III	8 369	82	8 974	105	9 614	140	3,96	12,2	3 800	1/2"-7/8"	< 10,0	97+65	35	8.490 €
ASH-DG-4 068	3 1/2	400 V-III	9 113	89	9 753	115	10 442	150	4,47	13,2	3 800	1/2"-7/8"	< 10,0	98+65	39	9.306 €

serie ASH

VERSIÓN CENTRÍFUGA			
SERIE / MODELO CENTRÍFUGOS	CAUDAL COND. (m³/h)	P.E.D. ⁽³⁾ (mmca)	PVP (€) CENTRIF.
ASH-CDY-11 015	575	12	4.271 €
ASH-CDY-11 026	575	12	4.619 €
ASH-CDY-11 033	575	12	5.186 €
ASH-CDY-22 033	1 000	6,5	5.690 €
ASH-CDY-22 053	1 000	6,5	6.625 €
ASH-CDY-33 053	1 500	14	7.017 €
ASH-CDY-33 074	1 500	14	8.342 €
ASH-CDY-43 086	3 500	10	9.512 €
ASH-CDY-43 108	3 500	10	10.437 €
ASH-CDY-44 108	3 500	10	11.438 €
ASH-CDY-44 136	3 500	10	12.583 €
ASH-CDG-1 010	575	12	3.987 €
ASH-CDG-1 012	575	12	4.158 €
ASH-CDG-2 014	1 000	6,5	4.325 €
ASH-CDG-2 016	1 000	6,5	4.483 €
ASH-CDG-2 018	1 000	6,5	4.716 €
ASH-CDG-2 024	1 000	6,5	5.257 €
ASH-CDG-3 026	1 500	14	5.690 €
ASH-CDG-3 034	1 850	14	6.335 €
ASH-CDG-3 038	1 850	14	7.284 €
ASH-CDG-4 048	3 500	10	7.983 €
ASH-CDG-4 054	3 500	10	8.430 €
ASH-CDG-4 060	3 500	10	9.182 €
ASH-CDG-4 068	3 500	10	9.998 €

- Opcionales
- Cambio a alimentación 400 V-III-50 Hz. * + 5%
 - Resistencia de cárter. + 72 €
 - Control de condensación proporcional:
 - versión axial (Q): + 295 €

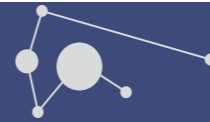

Equipos certificados en fábrica sin necesidad de ensayos in situ (RSIF).

Unidad condensadora silenciosa.

Diseño tropicalizado para temperatura ambiente de 50 °C.

Válvula de expansión termostática.

Control de condensación proporcional (opcional en versiones bajo perfil).

Precarga de refrigerante incluida.

Equipos exentos de control de fugas.

Descripción Equipos semicompactos para cámaras frigoríficas de pequeño y mediano tamaño, formados por una unidad condensadora silenciosa y una unidad evaporadora de bajo perfil, plafón de doble flujo o tipo cúbico.

- Características**
- Alimentación 230 V-I-50 Hz o 400 V-III-50 Hz.
 - Carga de refrigerante R-134a o R-449a reducida.
 - Compresor hermético alternativo.
 - Doble aislamiento acústico del compresor.
 - Amplia superficie de condensación en L (recta en series 0 y 1).
 - Ventiladores de condensación de baja velocidad.
 - Control de condensación proporcional (opcional en versiones-N).
 - Presostatos de alta y baja presión.
 - Silenciador de descarga (a partir de 1 CV) y resistencia de cárter.
 - Recipiente de líquido.
 - Precarga de refrigerante para hasta 10 m de tubería.
 - Evaporador: bajo perfil (versión-N) o tipo cúbico (versión-Q).
 - Válvula termostática y válvula solenoide integradas.
 - Desescarche por resistencia eléctrica (excepto serie ASF).
 - Bandeja de condensados en acero inoxidable.
 - Conexiones de tipo Flare (hasta 1/2"-3/4") y válvulas de servicio.
 - Protección magnetotérmica.
 - Regulación electrónica multifunción con mando a distancia y control de condensación digital.
 - Inyección de líquido en modelos de baja temperatura con R-449a.

Esquema de instalación

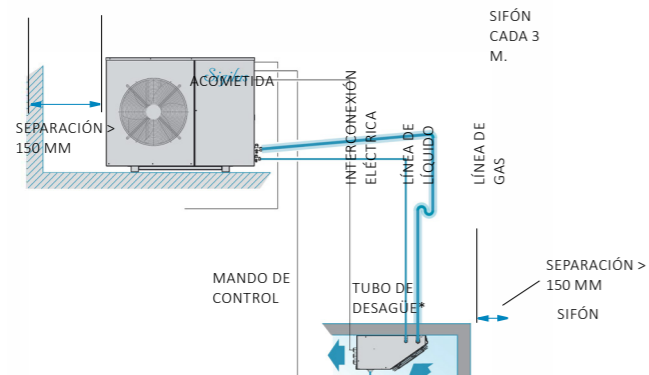

Características técnicas y constructivas sujetas a variación sin previo aviso.

Controlador electrónico

Los equipos Sigilus incorporan de serie el avanzado controlador electrónico XWING.



Mando multifunción de control digital a distancia.

Control de temperatura con registro de temperaturas máxima y mínima.

Modo de enfriamiento rápido y modo nocturno.

Triple insonorización acústica

Las unidades condensadoras de la serie Sigilus incorporan una triple insonorización acústica: Compartimento del compresor insonorizado y separado del flujo de aire.

Compresor hermético en camisa acústica y silenciador de descarga.

Ventiladores silenciosos de baja velocidad sobre estructura antivibratoria.

Control de condensación proporcional

Incorporamos en la serie Sigilus (opcional para las unidades con evaporador de bajo perfil) un control de condensación proporcional por variación de velocidad para funcionamiento prolongados con baja temperatura exterior.

Interconexiones eléctricas a prever en obra
Para la interconexión de las unidades condensadora y evaporadora se han de prever las siguientes secciones de cable (mangueras no incluidas):

Tensión	230 V-I-50 Hz	400 V-III-50 Hz
Sondas	4 x 1 mm ²	
Maniobra	2 x 1 mm ²	3 x 1 mm ²
Desescarche	2 x 1,5 mm ² + T	4 x 1,5 mm ² + T
Termostato	2 x 1 mm ²	
Interr. puerta*	2 x 1 mm ² (+ 2 x 1 mm ² en BT)	
Luz cámara *	2 x 1 mm ² + T	

* opcional no incluido

Distancia vertical máxima entre unidades de 15 m en caso de que la unidad condensadora esté situada a mayor altura que la unidad evaporadora, y de 6 m en caso contrario.

* Inclinación mínima del tubo de desagüe del 20% para modelos de baja temperatura.

We reserve the right to change specifications without prior notice.

230 V-I-50 Hz* / 400 V-III-50 Hz | Media temperatura | R134a / R449A

series MSF / BSF

SERIE / MODELO	COMPRESOR		POTENCIA FRIGORÍFICA / VOLUMEN CÁMARA, SEGÚN TEMPERATURA DE CÁMARA (1)								POTENCIA ABSORB. NOMINAL (kW)	INTENS. MÁXIMA ABSORB. (A)	VENT. EVAP.	CAUDAL EVAP. (m ³ /h)	CAUDAL COND. (m ³ /h)	CONEXIÓN FRIGORÍFICA LIQ.- GAS	CARGA REFRIG. (kg)	PESO (kg)	NIVEL PRESIÓN SONORA dB(A) (2)	PVP (€)
	CV	TENSIÓN	-5 °C		0 °C		5 °C		10 °C											
			W	m ³	W	m ³	W	m ³	W	m ³										
MSF-NY-00 010	3/8	230 V-I	497	2,9	637	5,0	788	8,8	945	13	0,41	4,2	1x Ø172	300	350	1/4"-3/8"	< 2,5	46+12	20	2.806 €
MSF-NY-00 015	1/2	230 V-I	653	3,6	832	7,4	1 004	11	1 188	16	0,51	5,2	1x Ø172	300	350	1/4"-3/8"	< 2,5	49+12	19	3.094 €
MSF-NY-11 015	1/2	230 V-I	805	4,7	1 031	10	1 296	14	1 582	28	0,56	5,6	1x Ø200	550	1 700	1/4"-1/2"	< 2,5	57+16	19	3.238 €
MSF-NY-11 026	3/4	230 V-I	1 076	9,0	1 412	16	1 738	25	2 084	40	0,80	9,2	1x Ø200	550	1 700	1/4"-1/2"	< 2,5	65+16	22	3.932 €
MSF-NY-12 033	1	230 V-I	1 475	13	1 859	20	2 289	35	2 741	57	1,02	9,7	2x Ø200	1 050	1 700	1/4"-5/8"	< 2,5	67+24	22	4.913 €
MSF-NY-12 053	1 1/2	230 V-I *	1 811	22	2 347	33	2 872	50	3 439	79	1,42	12,3	2x Ø200	1 050	1 700	1/4"-5/8"	< 2,5	77+24	27	5.761 €
MSF-NY-13 074	2	230 V-I *	2 772	30	3 528	50	4 363	76	5 229	125	1,94	17,2	3x Ø254	1 725	1 700	1/4"-3/4"	< 10,0	79+45	28	6.273 €
MSF-NY-23 086	4	400 V-III	3 355	39	4 384	65	5 376	108	6 437	160	2,18	14,1	3x Ø254	1 725	3 700	3/8"-7/8"	< 10,0	96+45	39	6.984 €
MSF-NY-24 108	5	400 V-III	4 347	58	5 649	90	6 920	138	8 316	220	2,83	18,2	4x Ø300	3 100	3 700	3/8"-7/8"	< 10,0	98+45	37	8.210 €
MSF-NY-24 136	6 1/2	400 V-III	5 486	75	6 899	110	8 363	150	9 949	280	3,55	22,2	4x Ø300	3 100	3 700	3/8"-1 1/8"	< 10,0	101+55	36	10.260 €
MSF-NY-34 171	8	400 V-III	6 080	88	7 613	130	9 240	200	10 978	350	4,16	25,2	4x Ø300	3 100	4 000	3/8"-1 1/8"	< 10,0	140+55	36	11.693 €
MSF-NG-0 008	1/3	230 V-I	611	2,9	759	5,0	915	8,8	1 103	13	0,43	5,1	1x Ø172	300	350	1/4"-3/8"	< 2,5	47+12	20	2.643 €
MSF-NG-0 010	3/8	230 V-I	739	3,6	894	6,1	1 056	10	1 254	15	0,53	4,8	1x Ø172	300	350	1/4"-3/8"	< 2,5	49+12	21	2.915 €
MSF-NG-0 012	1/2	230 V-I	818	4,7	981	7,4	1 153	12	1 358	21	0,63	5,6	1x Ø172	300	350	1/4"-3/8"	< 2,5	50+12	20	3.051 €
MSF-NG-1 014	1/2	230 V-I	882	8,0	1 095	12	1 322	20	1 585	34	0,77	6,5	1x Ø200	550	1 700	1/4"-1/2"	< 2,5	59+16	20	3.401 €
MSF-NG-1 016	5/8	230 V-I	972	10	1 210	15	1 462	24	1 759	40	0,81	7,4	1x Ø200	550	1 700	1/4"-1/2"	< 2,5	67+16	23	3.706 €
MSF-NG-1 018	3/4	230 V-I	1 397	12	1 649	19	1 915	28	2 245	45	0,94	8,7	1x Ø200	550	1 700	1/4"-1/2"	< 2,5	68+16	24	4.119 €
MSG-NG-2 024	1	230 V-I	1 513	14	1 958	22	2 420	35	2 958	57	1,26	11,1	2x Ø200	1 050	1 700	3/8"-5/8"	< 2,5	82+24	24	4.630 €
MSF-NG-2 026	1 1/4	230 V-I *	1 712	16	2 147	25	2 611	39	3 157	64	1,44	11,5	2x Ø200	1 050	1 700	3/8"-5/8"	< 2,5	83+24	27	4.837 €
MSF-NG-2 034	1 1/2	230 V-I *	2 120	21	2 606	33	3 117	50	3 730	79	1,83	16,1	2x Ø200	1 050	1 700	3/8"-5/8"	< 2,5	83+24	29	5.127 €
MSF-NG-3 038	1 3/4	400 V-III	2 770	29	3 394	46	4 078	71	4 894	112	1,89	8,1	3x Ø254	1 725	3 200	3/8"-5/8"	< 10,0	82+45	30	5.803 €
MSF-NG-4 048	2	400 V-III	3 368	39	4 231	62	5 158	92	6 225	145	2,34	9,6	3x Ø254	1 725	3 700	3/8"-3/4"	< 10,0	84+45	30	6.306 €
MSF-NG-4 054	2 1/4	400 V-III	3 792	47	4 671	70	5 640	105	6 780	160	2,54	10,1	3x Ø254	1 725	3 700	3/8"-3/4"	< 10,0	85+45	30	6.736 €

230 V-I-50 Hz* / 400 V-III-50 Hz | Baja temperatura | R449A

SERIE / MODELO	COMPRESOR		POTENCIA FRIGORÍFICA / VOLUMEN CÁMARA, SEGÚN TEMPERATURA DE CÁMARA (1)						POTENCIA ABSORB. NOMINAL (kW)	INTENS. MÁXIMA ABSORB. (A)	VENT. EVAP.	CAUDAL EVAP. (m ³ /h)	CAUDAL COND. (m ³ /h)	CONEXIÓN FRIGORÍFICA LIQ.- GAS	CARGA REFRIG. (kg)	PESO (kg)	NIVEL PRESIÓN SONORA dB(A) (2)	PVP (€)
	CV	TENSIÓN	-25 °C		-20 °C		-15 °C											
			W	m ³	W	m ³	W	m ³										
BSF-NG-0 018	5/8	230 V-I	486	1,1	613	2,3	749	4,1	0,50	4,7	1x Ø172	300	350	1/4"-1/2"	< 2,5	50+12	25	3.422 €
BSF-NG-1 026	3/4	230 V-I	763	3,2	952	7,0	1 155	13	0,82	8,5	1x Ø200	550	1 700	1/4"-1/2"	< 2,5	67+16	27	4.167 €
BSF-NG-2 034	1 1/4	230 V-I	930	3,9	1 107	8,1	1 437	15	1,18	11,3	2x Ø200	1 050	1 700	3/8"-5/8"	< 2,5	83+16	30	4.422 €
BSF-NG-2 055	1 3/4	230 V-I *	1 260	9	1 710	16	2 190	30	1,7	17,5	2x Ø200	1 050	1 700	1/4"-5/8"	< 2,5	85+24	42	5.414 €
BSF-NG-2 075	2	230 V-I *	1 655	13	2 130	22	2 625	38	2,1	25,5	2x Ø200	1 050	1 700	1/4"-5/8"	< 3,5	90+24	43	5.705 €
BSF-NG-3 075	2	230 V-I *	1 755	14	2 450	27	3 080	48	2,3	26,3	3x Ø254	1 725	1 700	1/4"-5/8"	< 3,5	90+45	43	6.118 €
BSF-NG-4 096	3 1/2	400 V-III	2 139	19	2 670	39	3 523	68	2,48	12,0	3x Ø254	1 725	3 700	3/8"-3/4"	< 10,0	97+45	40	7.929 €
BSF-NG-4 108	4 1/4	400 V-III	2 463	29	3 276	50	4 118	78	2,82	14,6	3x Ø254	1 725	3 700	3/8"-7/8"	< 10,0	97+45	38	8.583 €
BSF-NG-4 136	5	400 V-III	2 949	37	3 775	61	4 648	100	3,64	16,8	3x Ø254	1 725	3 700	3/8"-7/8"	< 10,0	100+45	34	9.259 €

Opcionales

- Control de condensación proporcional por variación de velocidad (excepto serie 0).
 - Cambio a alimentación 400 V-III-50 Hz. * + 304 €
 - Rejilla exterior de protección de la batería. + 5%
 - Ventiladores electrónicos en el evaporador. + 112 €
 - Refrigerante R452A. + 5%
 - Otros refrigerantes. + 0%
- Consultar

Dimensiones Evaporador

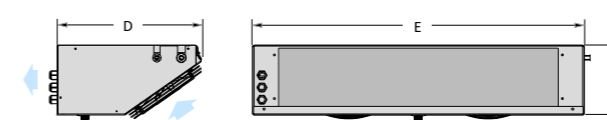

Dimensiones Condensador

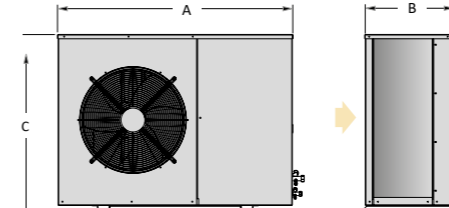

Características técnicas y constructivas sujetas a variación sin previo aviso.

(1) Las prestaciones nominales están referidas al funcionamiento con temperatura de cámara de 0°C (MT) y -20°C (BT), y temperatura exterior de 35°C. Volumen de cámara estimado según condiciones de las bases de cálculo (pág. VI).

(2) Nivel sonoro referido a nivel de presión acústica en dB(A), medido en campo abierto a 10 m de distancia de la fuente.

* Unidades disponibles en tensión 400 V-III-50 Hz.

Dimensiones (mm)	A	B	C	D	E	F	Ventiladores evaporador
series 0 y 00	670	305	440	407	520	150	1x Ø 172
series 1 y 11	1 030	373	577	418	600	200	1x Ø 200
series 2 y 12	1 030	373	577	418	950	200	2x Ø 200
series 3 y 13	1 030	373	577	510	1 650	200	3x Ø 254
series 4 y 23	1 080	410	827	510	1 650	200	3x Ø 254
serie 24	1 080	410	827	550	2 020	260	4x Ø 300
serie 34	1 150	481	1 097	550	2 020	260	4x Ø 300

We reserve the right to change specifications without prior notice.

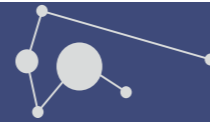

series MSF / BSF

230 V-I-50 Hz* / 400 V-III-50 Hz | Media temperatura | R134a / R449A

SERIE / MODELO	COMPRESOR		POTENCIA FRIGORÍFICA / VOLUMEN CÁMARA, SEGÚN TEMPERATURA DE CÁMARA (1)								POTENCIA ABSORB. NOMINAL (kW)	INTENS. MÁXIMA ABSORB. (A)	VENT. EVAP.	CAUDAL EVAP. (m³/h)	CAUDAL COND. (m³/h)	CONEXIÓN FRIGORÍFICA LIQ.-GAS	CARGA REFRIG. (kg)	PESO (kg)	NIVEL PRESIÓN SONORA dB(A) (2)	PVP (€)
	CV	TENSIÓN	-5°C		0°C		5°C		10°C											
			W	m³	W	m³	W	m³	W	m³										
MSF-QY-10 068	3 1/2	400 V-III	3 281	42	4 106	60	4 998	69	5 985	110	1,98	12,8	1x Ø350	2 100	3 200	1/4"-3/4"	< 10,0	82+43	36	7.511 €

230 V-I-50 Hz* / 400 V-III-50 Hz | Baja temperatura | R449A

SERIE / MODELO	COMPRESOR		POTENCIA FRIGORÍFICA / VOLUMEN CÁMARA, SEGÚN TEMPERATURA DE CÁMARA (1)						POTENCIA ABSORB. NOMINAL (kW)	INTENS. MÁXIMA ABSORB. (A)	VENT. EVAP.	CAUDAL EVAP. (m³/h)	CAUDAL COND. (m³/h)	CONEXIÓN FRIGORÍFICA LIQ.-GAS	CARGA REFRIG. (kg)	PESO (kg)	NIVEL PRESIÓN SONORA dB(A) (2)	PVP (€)
	CV	TENSIÓN	-25°C		-20°C		-15°C											
			W	m³	W	m³	W	m³										
BSF-QG-10 075	2	230 V-I *	1 717	14	2 410	24	2 967	43	2,3	25,1	1x Ø350	2 100	1 700	1/4"-5/8"	< 3	85+43	43	6.585 €

Opcionales

- Cambio a alimentación 400 V-III-50 Hz. * + 5%
- Rejilla exterior de protección de la batería. + 101 €
- Ventiladores electrónicos en el evaporador. + 5%
- Refrigerante R452A. + 0%
- Otros refrigerantes.

Dimensiones Evaporador

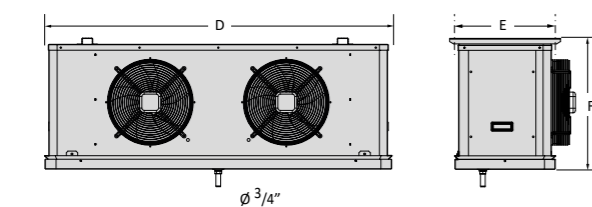

Dimensiones Condensador

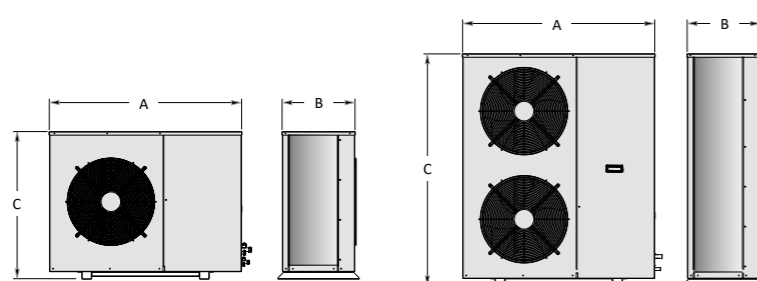

(1) Las prestaciones nominales están referidas al funcionamiento con temperatura de cámara de 0°C (MT) y -20°C (BT), y temperatura exterior de 35°C. Volumen de cámara estimado según condiciones de las bases de cálculo (pág. VI).

(2) Nivel sonoro referido a nivel de presión acústica en dB(A), medido en campo abierto a 10 m de distancia de la fuente.

* Unidades disponibles en tensión 400 V-III-50 Hz.

Dimensiones (mm)	A	B	C	D	E	F
serie 10	1030	373	577	882	465	576
serie 20	1080	410	827	882	465	576
serie 21	1080	410	827	1 232	465	576
serie 22	1080	410	827	1 534	465	576
serie 32	1 150	481	1 097	1 534	465	576
serie 33	1 150	481	1 097	1 933	465	576
serie 34	1 150	481	1 097	2 432	465	576
serie 43	1 150	481	1 347	1 933	465	576
serie 44	1 150	481	1 347	2 432	465	576

serie ASF

230 V-I-50 Hz* / 400 V-III-50 Hz | Alta temperatura | R134a / R449A

SERIE / MODELO	COMPRESOR		POTENCIA FRIGORÍFICA / VOLUMEN CÁMARA, SEGÚN TEMPERATURA DE CÁMARA (1)						POTENCIA ABSORB. NOMINAL (kW)	INTENS. MÁXIMA ABSORB. (A)	CAUDAL EVAP. (m³/h)	CAUDAL COND. (m³/h)	CONEXIÓN FRIGORÍFICA LIQ.-GAS	CARGA REFRIG. (kg)	PESO (kg)	NIVEL PRESIÓN SONORA dB(A) (2)	PVP (€)
	CV	TENSIÓN	+9°C		+12°C		+15°C										
			W	m³	W	m³	W	m³									
ASF-DY-11 015	1/2	230 V-I	1 687	16	1 922	21	2 160	29	0,69	4,7	1 100	1 700	1/4"-1/2"	< 2,5	57+32	20	4.450 €

Opcionales

- Control de condensación proporcional por variación de velocidad (ya incluido en serie 2/23 y superiores). + 304 €
- Cambio a alimentación 400 V-III-50 Hz. * + 5%
- Rejilla exterior de protección de la batería. + 112 €
- Refrigerante R452A. + 0%
- Otros refrigerantes.

(1) Las prestaciones nominales están referidas al funcionamiento con temperatura de cámara de 12°C (AT) y temperatura exterior de 35°C. Volumen de sala estimado según condiciones de las bases de cálculo (pág. VI).

(2) Nivel sonoro referido a nivel de presión acústica en dB(A), medido en campo abierto a 10 m de distancia de la fuente.

* Unidades disponibles en tensión 400 V-III-50 Hz.

Dimensiones Evaporador

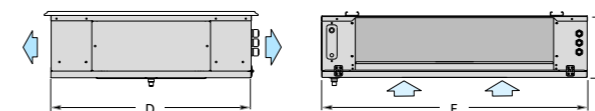

Dimensiones Condensador

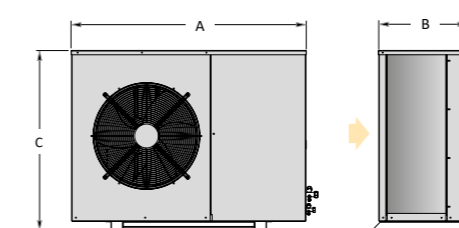

Dimensiones (mm)	A	B	C	D	E	F	Ventiladores evaporador
serie 11	1030	373	577	762	706	250	1x Ø 360
serie 12	1030	373	577	762	1056	250	2x Ø 360
serie 13	1030	373	577	762	1756	250	3x Ø 360
serie 23	1080	410	827	762	1756	250	3x Ø 360
serie 24	1080	410	827	852	2156	300	3x Ø 450
serie 34	1150	481	1097	852	2156	300	3x Ø 450
serie 44	1150	481	1347	852	2156	300	3x Ø 450
ASF-DG-1016 y 1018	1030	373	577	762	706	250	1x Ø 360
ASF-DG-1024 a 1034	1030	373	577	762	1056	250	2x Ø 360
ASF-DG-1038	1030	373	577	762	1756	250	3x Ø 360
serie 2	1080	410	827	762	1756	250	3x Ø 360
serie 3	1150	481	1097	762	1756	250	3x Ø 360
serie 4	1150	481	1347	852	2156	300	3x Ø 450

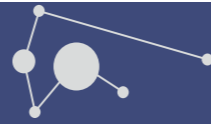

Descripción Equipos semicompactos de refrigeración a media temperatura formados por una unidad motocondensadora en versión silenciosa, horizontal o centrífuga, y una unidad evaporadora de tipo plafón quasiestático.

- Características**
- Alimentación 230 V-I-50 Hz o 400 V-III-50 Hz.
 - Carga de refrigerante R-134a o R-449A reducida.
 - Compresor hermético alternativo.
 - Evaporador de plafón quasiestático de doble flujo de aire con ventiladores axiales regulados a muy baja velocidad.
 - Presostatos de alta y baja presión.
 - Válvula solenoide.
 - Expansión por válvula termostática.
 - Desescarche por resistencias eléctricas.
 - Bandeja de condensados en acero inoxidable.
 - Conexiones de tipo Flare (hasta 1/2"-3/4") y válvulas de servicio.
 - Protección magnetotérmica.
 - Recipiente de líquido.
 - Precarga de refrigerante para hasta 10 m de tubería.
 - Regulación electrónica multifunción con mando a distancia y control de condensación digital.

Versión MSF-U Equipos compuestos por una unidad motocondensadora silenciosa, y una unidad evaporadora quasiestática de tipo plafón.

Versión MSH-CU Equipos compuestos por una unidad motocondensadora centrífuga y una unidad evaporadora quasiestática de tipo plafón.

Esquema de instalación

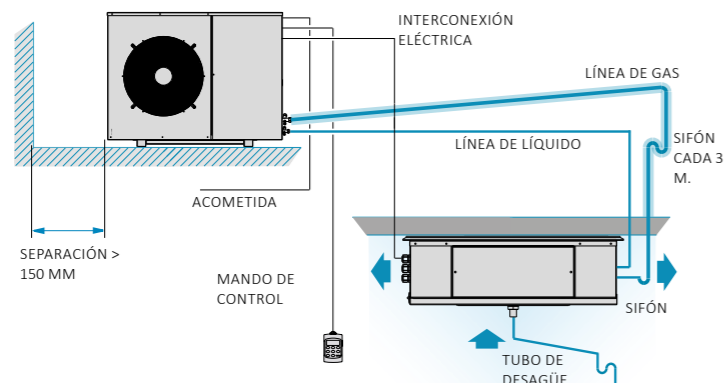

Distancia vertical máxima entre unidades de 15 m en caso de que la unidad condensadora esté situada a mayor altura que la unidad evaporadora, y de 6 m en caso contrario.

Evaporador quasiestático de doble flujo a muy baja velocidad, especialmente diseñado para conservación de carne.

Equipos certificados en fábrica sin necesidad de ensayos in situ. (Reglamento Seguridad de Instalaciones Frigoríficas).

Precarga de refrigerante incluida.

Equipos exentos de control de fugas.

Conservación de carne

Los equipos quasiestáticos, gracias a la configuración de sus unidades evaporadoras, están especialmente indicados para cámaras de conservación de carne en el entorno de los 0 °C.

Los evaporadores de doble flujo de aire incorporan ventiladores ajustados a una mínima velocidad de giro para simular la circulación de aire por convección natural al igual que un evaporador de tipo estático.

De este modo se obtiene una mínima velocidad de aire para evitar la pérdida de humedad del producto, a la vez que se mantiene una adecuada humedad relativa en el interior de la cámara para evitar la proliferación bacteriana en la superficie del producto.



Maduración de carne (opcional)

La maduración de carne requiere el control de la humedad relativa de la cámara en un rango determinado.

Los equipos para la maduración de carne, están configurados para cámaras en el entorno de los 0 °C y humedad relativa en el rango del 40% al 95%.

Estos equipos incorporan una avanzada regulación electrónica para el control de la temperatura y humedad en el interior de la cámara, con funciones de deshumidificación y humidificación a vapor de 3 kg/h de capacidad, compuesto por: lanzas de vapor integradas en la unidad evaporadora, un cilindro generador de electrodos sumergidos con válvulas de alimentación y purga de agua, y controlador electrónico de la humedad relativa en la cámara.



Resistencia de cárter

De serie en todos los equipos Sigilus MSF y opcional en series MSH. Se recomienda su inclusión en equipos instalados en intemperie.

230 V-I-50 Hz* / 400 V-III-50 Hz | Media temperatura- Quasiestático | R134a / R449A

series MSF-U / MSH-CU

SERIE / MODELO	COMPRESOR		POTENCIA FRIGORÍFICA / VOLUMEN CÁMARA, SEGÚN TEMPERATURA DE CÁMARA (1)								POTENCIA ABSORB. NOMINAL (KW)	INTENS. MÁXIMA ABSORB. (A)	CAUDAL EVAP. (m³/h)	CAUDAL COND. (m³/h)	CONEXIÓN FRIGORÍFICA LIQ.-GAS	CARGA REFRIG. (kg)	PESO (kg)	NIVEL PRESIÓN SONORA dB(A) (2)	PVP (€) AXIAL
	CV	TENSIÓN	-5 °C		+0 °C		+5 °C		+10 °C										
			W	m³	W	m³	W	m³	W	m³									
MSF-UY-11 026	3/4	230 V-I	1 145	7,6	1 449	15	1 785	24	2 153	41	0,83	9,4	600	1 700	1/4"-1/2"	< 2,0	65+32	22	4.519 €
MSF-UY-12 033	1	230 V-I	1 428	12	1 764	20	2 147	34	2 562	53	0,96	10,0	700	1 700	1/4"-5/8"	< 3,0	67+45	22	5.385 €
MSF-UY-13 053	1 1/2	230 V-I *	2 100	22	2 657	40	3 255	56	3 938	86	1,50	12,6	1 325	1 700	1/4"-3/4"	< 3,5	77+65	27	6.729 €
MSF-UY-13 074	2	230 V-I *	2 741	30	3 434	48	4 190	74	5 009	120	1,86	16,9	1 325	1 700	1/4"-3/4"	< 4,5	79+65	28	7.691 €
MSF-UY-23 086	4	400 V-III	3 308	40	4 158	62	5 114	99	6 132	154	2,08	13,4	1 325	3 700	3/8"-7/8"	< 5,5	96+65	39	8.408 €
MSF-UY-24 108	5	400 V-III	4 431	54	5 576	87	6 825	134	8 243	209	2,74	16,9	2 600	3 700	3/8"-7/8"	< 7,5	98+65	37	9.605 €
MSF-UY-24 136	6 1/2	400 V-III	5 444	72	6 815	108	8 306	162	10 038	268	3,44	20,9	2 600	3 700	3/8"-1 1/8"	< 7,5	101+65	36	10.784 €
MSF-UY-34 171	8	400 V-III	11 151	153	7 539	123	9 293	181	11 146	299	4,06	23,9	2 600	4 000	3/8"-1 1/8"	< 8,0	140+65	40	12.777 €
MSF-UG-1 016	5/8	230 V-I	1 215	9,5	1 483	15	1 772	25	2 101	40	0,89	7,5	600	1 700	1/4"-1/2"	< 2,5	67+32	23	4.299 €
MSF-UG-1 018	3/4	230 V-I	1 421	12	1 720	19	2 050	30	2 410	48	1,03	8,8	600	1 700	1/4"-1/2"	< 2,5	68+32	24	4.941 €
MSF-UG-1 024	1	230 V-I	1 648	15	1 998	24	2 390	37	2 812	59	1,19	11,0	700	1 700	3/8"-5/8"	< 3,5	82+43	24	5.304 €
MSF-UG-1 034	1 1/2	230 V-I *	2 235	23	2 699	35	3 193	54	3 739	84	1,84	16,0	700	1 700	3/8"-5/8"	< 3,5	83+43	29	6.047 €
MSF-UG-1 038	1 3/4	400 V-III	2 833	31	3 451	47	4 130	72	4 882	115	1,85	7,4	1 325	3 200	3/8"-5/8"	< 4,5	82+63	30	7.076 €
MSF-UG-2 054	2 1/2	400 V-III	3 784	47	4 600	70	5 447	105	6 426	160	2,38	9,4	1 325	3 700	3/8"-3/4"	< 5,5	85+63	30	7.837 €
MSF-UG-2 068	3 1/2	400 V-III	4 825	64	5 794	93	6 834	135	8 017	205	3,35	11,4	1 325	3 700	1/2"-3/4"	< 7,0	88+63	29	9.689 €
MSF-UG-3 086	4	400 V-III	6 027	83	7 257	120	8 579	175	10 060	270	4,23	13,9	2 600	4 000	1/2"-7/8"	< 7,0	115+66	39	11.479 €

(1) Las prestaciones nominales están referidas al funcionamiento con temperatura de cámara de 0°C y temperatura exterior de 35°C. Volumen de cámara estimado según condiciones de las bases de cálculo (pág. VI).

(2) Nivel sonoro referido a nivel de presión acústica en dB(A), medido en campo abierto a 10 m de distancia de la fuente.

* Unidades disponibles en tensión 400 V-III-50 Hz.

Opcionales

- Control de condensación proporcional por variación de velocidad (incluido en serie MSF 2/23 y superiores). + 304 €
- Cambio a alimentación 400 V-III-50 Hz. * + 5%
- Rejilla exterior de protección de la batería. + 112 €
- Refrigerante R452A. + 0%
- Otros refrigerantes.

Versión centrífuga, serie MSH-CU

Los equipos quasiestáticos se encuentran también disponibles en versión con condensadora centrífuga.

Dimensiones Evaporador

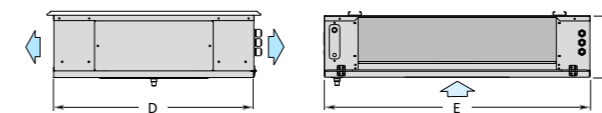

Dimensiones Condensador

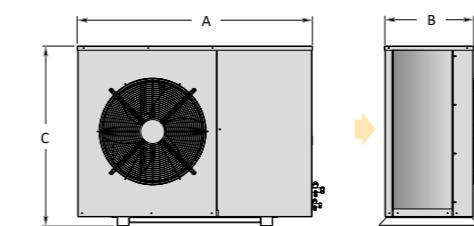

Dimensiones (mm)	A	B	C	D	E	F	Ventiladores evaporador
serie 11	1030	373	577	762	706	250	1x Ø 360
serie 12	1030	373	577	762	1056	250	1x Ø 360
serie 13	1030	373	577	762	1756	250	2x Ø 360
serie 23	1080	410	827	762	1756	250	2x Ø 360
serie 24	1080	410	827	852	2156	300	2x Ø 450
serie 34	1150	481	1097	852	2156	300	2x Ø 450
MSF-UG-1014 a 1018	1030	373	577	762	706	250	1x Ø 360
MSF-UG-1024 a 1034	1030	373	577	762	1056	250	1x Ø 360
MSF-UG-1038	1030	373	577	762	1756	250	2x Ø 360
MSF-UG-2048 a 2068	1080	410	827	762	1756	250	2x Ø 360
MSF-UG-3086	1150	481	1097	852	2156	300	2x Ø 450

SERIE / MODELO	CV	P. FRIGORÍFICA		PVP (€)
		0 °C / 35 °C	W	
MSH-CUY-11 026	3/4	1 281	12	4.245 €
MSH-CUY-11 033	1	1 517	15	5.163 €
MSH-CUY-22 033	1	1 811	22	5.514 €
MSH-CUY-22 053	1 1/2	2 174	28	6.081 €
MSH-CUY-33 053	1 1/2	2 657	35	6.665 €
MSH-CUY-33 074	2	3 402	47	7.461 €
MSH-CUY-43 086	4	4 153	70	8.973 €
MSH-CUY-43 108	5	5 219	84	9.802 €
MSH-CUY-44 108	5	5 555	89	10.554 €
MSH-CUY-44 136	6 1/2	6 773	108	13.085 €
MSH-CUG-1016	5/8	1 349	13	4.039 €
MSH-CUG-1018	3/4	1 545	16	4.911 €
MSH-CUG-2024	1	1 978	23	5.245 €
MSH-CUG-2034	1 1/2	2 627	34	5.989 €
MSH-CUG-3038	1 3/4	3 265	44	6.870 €
MSH-CUG-4054	2 1/4	4 590	69	8.060 €
MSH-CUG-4068	3 1/2	5 783	93	9.478 €



Evaporador de tipo plafón de doble flujo, dimensionado para aplicaciones de alta humedad relativa.

Control pasivo de humedad (regulación entre 60% y 95%)*.

Equipos certificados en fábrica sin necesidad de ensayos in situ.

(Reglamento Seguridad de Instalaciones Frigoríficas).

Precarga de refrigerante incluida.

Equipos exentos de control de fugas.

Conservación a humedad relativa controlada

La conservación de ciertos productos, tales como frutas, verduras o flor cortada, requiere el control de la humedad relativa en la cámara dentro de un rango determinado.

Estos equipos ajustados para alta humedad relativa están especialmente indicados para cámaras de conservación de productos hortofrutícolas.

Los evaporadores cuentan con una doble impulsión de aire a través de baterías sobredimensionadas para poder obtener hasta un alto nivel de humedad relativa en el interior de la cámara en torno al 95%, evitando así la pérdida de humedad y de peso del producto.

Control electrónico de temperatura y humedad
Los equipos incorporan una avanzada regulación electrónica para el control de la temperatura y humedad en el interior de la cámara.

Mando multifunción de control digital a distancia con visualización de la temperatura y humedad relativa.

Control de humedad relativa en el rango de regulación del 60% al 95%*.

Opcionalmente se integran kits de humidificación activa con lanzas de vapor y kits de deshumectación y estufaje.

* La regulación de humedad en la cámara se realiza de forma pasiva, actuando sobre el caudal de ventilación del evaporador, sin aporte de vapor de agua. El rango real de regulación de humedad depende en gran medida de las condiciones de la cámara, humedad absoluta exterior y tipo de producto.

Interconexiones eléctricas

Se ha de prever en obra las siguientes secciones de cables de interconexión (incluidas de fábrica en series HSH con 10 m de longitud).

Tensión	230 V-I-50 Hz	400 V-III-50 Hz
Sondas	2 x 1 mm ² + 2 x 1 mm ²	
Maniobra *	3 x 1 mm ² + T	6 x 1 mm ² + T*
Termostato	2 x 1 mm ²	

* Interconexiones eléctricas de maniobra para los modelos HSF-DY-14 074 a 24 136, y HSF-DG-3 086.

Descripción
Equipos semicompactos de refrigeración con control de humedad, constituidos por una unidad motocondensadora silenciosa, o centrífuga, y una unidad evaporadora de tipo plafón con doble flujo de aire, dimensionada para aplicaciones con alta humedad relativa.

- Características**
- Alimentación 230 V-I-50 Hz o 400 V-III-50 Hz.
 - Carga de refrigerante R-134a o R-449A reducida.
 - Compresor hermético alternativo.
 - Presostatos de alta y baja presión.
 - Evaporador de plafón con doble flujo de aire dimensionado para una regulación de humedad relativa del 60% al 95%*.
 - Válvula solenoide y válvula de expansión termostática integradas en el evaporador.
 - Desescarche por aire.
 - Bandeja de condensados en acero inoxidable.
 - Conexiones de tipo Flare (hasta 1/2"-3/4") y válvulas de servicio.
 - Protección magnetotérmica.
 - Recipiente de líquido.
 - Precarga de refrigerante para hasta 10 m de tubería.
 - Regulación electrónica multifunción con control de temperatura y humedad y mando a distancia.

Versión HSF-D
Equipos compuestos por una unidad motocondensadora silenciosa y una unidad evaporadora de doble flujo de alta humedad relativa.

Versión HSH-CD
Equipos compuestos por una unidad motocondensadora centrífuga y una unidad evaporadora de doble flujo de alta humedad relativa

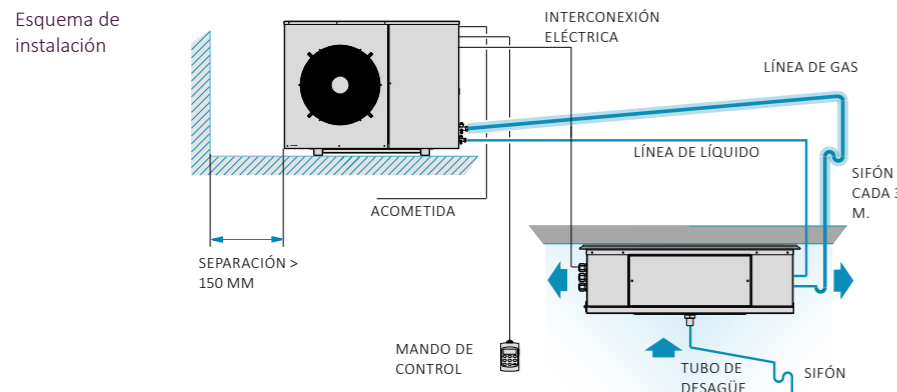

Distancia vertical máxima entre unidades de 15 m en caso de que la unidad condensadora esté situada a mayor altura que la unidad evaporadora, y de 6 m en caso contrario.

230 V-I-50 Hz* / 400 V-III-50 Hz | Media temperatura- Control de humedad | R134a / R449A

serie HSF-D / HSH-CD

SERIE / MODELO	COMPRESOR		POTENCIA FRIGORÍFICA / VOLUMEN CÁMARA, SEGÚN TEMPERATURA DE CÁMARA ⁽¹⁾						POTENCIA ABSORB. NOMINAL (kW)	INTENS. MÁXIMA ABSORB. (A)	CAUDAL EVAP. (m ³ /h)	CAUDAL COND. (m ³ /h)	CONEXIÓN FRIGORÍFICA LIQ.-GAS	CARGA REFRIG. (kg)	PESO (kg)	NIVEL PRESIÓN SONORA dB(A) ⁽²⁾	PVP (€)	
	CV	TENSIÓN	0 °C HR 95%		5 °C HR 95%		10 °C HR 95%											
			W	m ³	W	m ³	W	m ³										
R134a	HSF-DY-12 015	1/2	230 V-I	1 220	13	1 544	22	1 906	38	0,74	6,5	1 800	1 700	1/4"-1/2"	< 2,5	57+32	20	4.612 €
	HSF-DY-12 026	3/4	230 V-I	1 701	19	2 116	32	2 594	53	1,06	10,2	1 800	1 700	1/4"-1/2"	< 2,5	65+32	22	4.982 €
	HSF-DY-13 033	1	230 V-I	2 105	25	2 620	43	3 192	73	1,30	11,0	3 150	1 700	1/4"-1/2"	< 10,0	67+45	22	6.128 €
	HSF-DY-13 053	1 1/2	230 V-I *	2 814	37	3 486	64	4 237	103	1,90	13,6	3 150	1 700	1/4"-5/8"	< 10,0	77+65	27	7.296 €
	HSF-DY-14 074	2	230 V-I *	3 980	57	4 977	91	6 090	148	2,57	17,7	5 700	1 700	1/4"-3/4"	< 10,0	79+65	28	8.573 €
	HSF-DY-24 086	4	400 V-III	5 465	56	6 773	134	8 311	217	2,87	14,5	5 700	3 700	3/8"-7/8"	< 10,0	96+65	39	9.670 €
	HSF-DY-24 108	5	400 V-III	6 389	102	7 865	158	9 713	263	3,40	17,5	5 700	3 700	3/8"-7/8"	< 10,0	98+65	37	10.595 €
	HSF-DY-24 136	6 1/2	400 V-III	7 985	136	9 870	202	11 960	331	4,44	21,5	5 700	3 700	3/8"-1 1/8"	< 10,0	101+70	36	13.922 €
R449A	HSF-DG-1 014	1/2	230 V-I	1 530	15	1 801	25	2 112	41	0,85	6,6	1 100	1 700	1/4"-1/2"	< 2,5	59+32	20	4.447 €
	HSF-DG-1 016	5/8	230 V-I	1 708	18	2 015	29	2 378	47	0,93	7,5	1 100	1 700	1/4"-1/2"	< 2,5	67+32	23	4.802 €
	HSF-DG-1 018	3/4	230 V-I	2 162	24	2 582	38	3 036	62	1,22	9,1	1 800	1 700	1/4"-1/2"	< 2,5	68+45	24	5.716 €
	HSF-DG-1 024	1	230 V-I	2 461	30	2 945	46	3 478	75	1,40	11,3	1 800	1 700	3/8"-5/8"	< 10,0	82+45	24	6.103 €
	HSF-DG-1 026	1 1/4	230 V-I *	2 798	35	3 289	54	3 849	86	1,53	16,3	1 800	1 700	3/8"-5/8"	< 10,0	83+45	27	6.397 €
	HSF-DG-1 034	1 1/2	230 V-I *	3 188	43	3 734	64	4 361	100	2,09	5,9	1 800	1 700	3/8"-5/8"	< 10,0	83+45	29	6.894 €
	HSF-DG-1 038	1 3/4	400 V-III	4 130	55	4 905	85	5 760	135	2,02	7,8	3 150	3 200	3/8"-5/8"	< 10,0	82+65	30	7.999 €
	HSF-DG-2 048	2	400 V-III	5 250	76	6 170	115	7 244	175	2,53	7,9	3 150	3 700	3/8"-3/4"	< 10,0	84+65	30	8.505 €
	HSF-DG-2 054	2 1/4	400 V-III	5 881	87	6 852	130	7 997	200	2,77	9,8	3 150	3 700	3/8"-3/4"	< 10,0	85+65	30	8.808 €
	HSF-DG-2 060	3	400 V-III	6 728	100	7 844	150	9 122	230	3,28	11,3	3 800	3 700	3/8"-3/4"	< 10,0	88+65	29	9.650 €
	HSF-DG-2 068	3 1/2	400 V-III	7 399	115	8 576	165	9 934	260	3,77	12,3	3 800	3 700	1/2"-3/4"	< 10,0	88+65	29	10.778 €
	HSF-DG-3 086	4	400 V-III	8 722	140	10 308	200	12 124	320	4,74	14,5	5 700	4 000	1/2"-7/8"	< 10,0	115+70	39	12.679 €

- Opcionales**
- Control de condensación proporcional por variación de velocidad (incluido en HSF serie 2/22 y superiores). + 304 €
 - Cambio a alimentación 400 V-III-50 Hz. * + 5%
 - Rejilla exterior de protección de la batería. + 112 €
 - Kit de humidificación activa integrado. consultar
 - Kit de deshumectación y estufaje. consultar
 - Refrigerante R452A. + 0%
 - Otros refrigerantes.

⁽¹⁾ Las prestaciones nominales están referidas al funcionamiento con temperatura de cámara de 5°C, humedad relativa de cámara del 95% y temperatura exterior de 35°C. Volumen de cámara estimado según condiciones de las bases de cálculo (pág. VI).

⁽²⁾ Nivel sonoro referido a nivel de presión acústica en dB(A), medido en campo abierto a 10 m de distancia de la fuente.

* Unidades disponibles en tensión 400 V-III-50 Hz.

Versión centrífuga, serie HSH-CD

Los equipos con control de humedad relativa se encuentran también disponibles en versión con condensadora centrífuga.

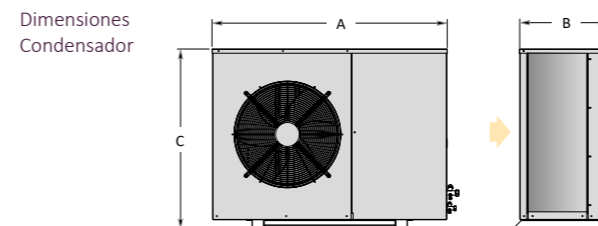
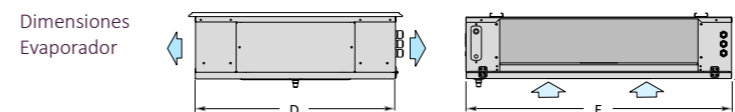

Dimensiones (mm)	A	B	C	D	E	F	Ventiladores evaporador
	serie 12	1030	373	577	762	1056	
serie 13	1030	373	577	762	1756	250	3x Ø 360
serie 14	1030	373	577	852	2156	250	3x Ø 450
serie 24	1080	410	827	852	2156	300	3x Ø 450
HSF-DG-1014 y 1016	1030	373	577	762	706	250	1x Ø 360
HSF-DG-1018 a 1034	1030	373	577	762	1056	250	2x Ø 360
HSF-DG-1038	1030	373	577	762	1756	250	3x Ø 360
HSF-DG-2048 a 2068	1080	410	827	762	1756	250	3x Ø 360
HSF-DG-3086	1150	481	1097	852	2156	300	3x Ø 450

SERIE / MODELO	CV	P. FRIGORÍFICA		PVP (€)	
		5 °C HR 95	W		m ³
R134a	HSH-CDY-12 015	1/2	1415	21	4.399 €
	HSH-CDY-12 026	3/4	1859	28	5.052 €
	HSH-CDY-12 033	1	2242	32	5.550 €
	HSH-CDY-23 033	1	2746	45	5.912 €
	HSH-CDY-23 053	1 1/2	3507	64	6.510 €
	HSH-CDY-23 074	2	4526	82	8.094 €
	HSH-CDY-34 074	2	5140	93	8.510 €
	HSH-CDY-44 086	4	6741	134	9.660 €
	HSH-CDY-44 108	5	7817	158	10.514 €
	HSH-CDY-44 136	6 1/2	9791	200	13.036 €
R449A	HSH-CDG-1 014	1/2	1399	20	4.242 €
	HSH-CDG-1 016	5/8	1608	22	4.395 €
	HSH-CDG-2 018	3/4	2510	38	5.353 €
	HSH-CDG-2 024	1	2902	46	5.702 €
	HSH-CDG-2 026	1 1/4	3242	54	5.930 €
	HSH-CDG-2 034	1 1/2	4056	71	
	HSH-CDG-3 038	1 3/4	4360	77	7.554 €
	HSH-CDG-3 048	2	6160	116	8.332 €
	HSH-CDG-4 054	2 1/4	6833	132	8.799 €
	HSH-CDG-4 060	3	7652	149	9.576 €
HSH-CDG-4 068	3 1/2	8371	164	10.279 €	

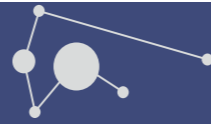

Equipos especialmente diseñados para conservación de vino en bodegas y cavas.
Control activo de humedad.
Sistema de calentamiento activo.
Equipos certificados en fábrica sin necesidad de ensayos in situ (RSIF).
Precarga de refrigerante incluida.
Equipos exentos de control de fugas.

Descripción Equipos para acondicionamiento de bodegas, en construcción semicompacta con unidad motocondensadora silenciosa o centrífuga y unidad evaporadora de tipo plafón con doble flujo de aire, dotada de resistencias de calentamiento, sistema de humidificación / deshumidificación, bomba de condensados, y en construcción compacta de techo, con condensación axial o centrífuga.

Aplicación

- Conservación de vino embotellado.
- Conservación de tabaco.
- Refrigeración de recintos a alta temperatura con humedad controlada.
- Conservación de vino en barricas.
- Curado de quesos.
- Minisecaderos de embutidos.

Serie VSF-G Equipo semicompacto para bodegas con condensadora axial silenciosa.

Serie VSH-CG Equipo semicompacto para bodegas con condensadora centrífuga.

Serie VCR-N Equipo compacto para bodegas con condensadora axial.

Serie VCR-C Equipo compacto para bodegas con condensadora centrífuga.

Esquema de instalación semicompactos

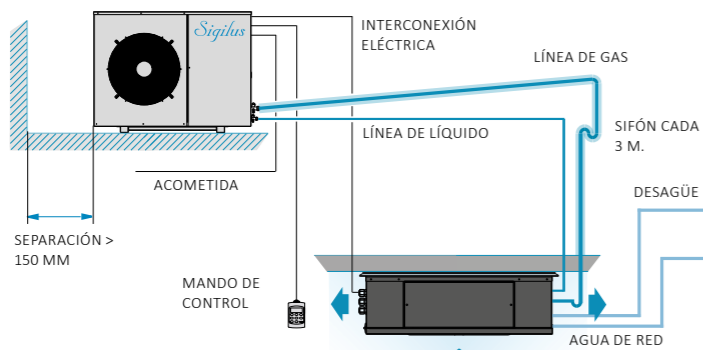

Distancia vertical máxima entre unidades de 15 m en caso de que la unidad condensadora esté situada a mayor altura que la unidad evaporadora, y de 6 m en caso contrario.

Esquema de instalación compactos

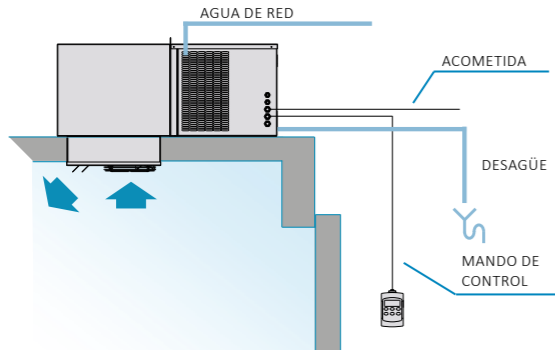

Características técnicas y constructivas sujetas a variación sin previo aviso.

We reserve the right to change specifications without prior notice.

- Características**
- Alimentación 230 V-I-50 Hz o 400 V-III-50 Hz.
 - Carga de refrigerante R-134a o R-449A reducida.
 - Compresor hermético alternativo.
 - Evaporador de plafón de doble flujo de aire con resistencias de calentamiento y sistema de humidificación / deshumidificación; baterías de evaporación con recubrimiento anticorrosión.
 - Desescarche por aire; filtro de aire.
 - Válvula solenoide y válvula de expansión termostática integradas en el evaporador.
 - Bandeja de condensados en acero inoxidable y bomba de condensados.
 - Conexiones de tipo Flare (hasta 1/2"-3/4") y válvulas de servicio.
 - Recipiente de líquido con precarga de refrigerante para hasta 10 m de tubería.
 - Control de condensación proporcional (series VSF 1/2/3 y VSH 4/43) y control de condensación todo / nada (series VSF 0 y VSH 2/22 y 3/33).
 - Regulación electrónica multifunción con control de temperatura / humedad, y mando a distancia.
 - Protección magnetotérmica.

serie VSF-G / VSH-CG



Conservación de vino embotellado

El vino embotellado requiere condiciones controladas tanto de temperatura como de humedad que conserven de forma óptima el producto a la vez que eviten tanto el secado del corcho como el enmohecimiento de las etiquetas.

Los equipos de tratamiento de vinos garantizan condiciones óptimas de conservación de vino embotellado.



Conservación de vino en barrica

En la conservación del vino en barricas tiene una gran importancia la humedad relativa en el interior de la bodega, la cual debe estar ajustada para que no se produzca trasvase de vapor de agua entre el ambiente de la bodega y el interior de la barrica, evitando así mermas de vino o absorción de agua por parte del contenido.



Interconexiones eléctricas (eq. semicompactos)

Se ha de prever en obra las siguientes secciones de cables de interconexión (incluidas de fábrica en series VSH con 10 m de longitud).

Tensión	230 V-I-50 Hz	400 V-III-50 Hz
Sondas	2 x 1 mm ² + 2 x 1 mm ²	
Maniobra	10 x 1 mm ²	10 x 1 mm ²
Resistencias	2 x 2,5 mm ² + T	4 x 1,5 mm ² + T
Termostato	2 x 1 mm ²	

Bodegas

SERIE / MODELO	COMPRESOR		VOLUMEN BODEGA (m ³)		POTENCIA FRIGORÍFICA A 15°C 70% HR (W) ⁽¹⁾	POTENCIA CALDRÍFICA (W)	POTENCIA ABSORB. NOMINAL (kW) ⁽²⁾	POTENCIA ABSORBIDA NOMINAL (kW) ⁽³⁾	INTENS. MÁXIMA ABSORB. (A)	CAUDAL EVAP. (m ³ /h)	CAUDAL COND. (m ³ /h)	CONEXIÓN FRIGORÍFICA LIQ. GAS	CARGA REFRIG. (kg)	PESO (kg)	NIVEL PRESIÓN SONORA dB(A) ⁽⁴⁾	PVP (€)	
	CV	TENSIÓN	SIN AISLAR	AISLADA													
R134a	VSF-GY-00 010	3/8	230 V-I	11	37	1242	1000	1,52	0,52	8,8	500	350	1/4"-3/8"	< 2,5	46+30	20	6.362 €
	VSF-GY-10 015	1/2	230 V-I	20	53	1820	1000	1,67	0,67	10,1	500	1700	1/4"-1/2"	< 2,5	57+30	21	7.251 €
	VSF-GY-11 033	1	230 V-I	47	100	3281	1500	2,76	1,26	16,3	1100	1700	1/4"-5/8"	< 10,0	67+42	22	8.728 €
	VSF-GY-12 053	1 1/2	230 V-I *	74	168	4683	3000	4,93	1,93	26,1	1800	3200	3/8"-3/4"	< 10,0	77+52	27	10.808 €
	VSF-GY-23 074	2	230 V-I *	149	297	7497	6000	8,60	2,60	43,7	3150	3700	3/8"-3/4"	< 10,0	79+75	28	14.254 €
VSF-GY-33 108	5	400 V-III	224	444	9944	6000	9,50	3,50	26,1	3150	4000	3/8"-7/8"	< 10,0	98+75	30	16.691 €	
R449A	VSF-GG-0 008	1/3	230 V-I	10	35	1227	1000	1,16	0,12	8,4	500	350	1/4"-3/8"	< 2,5	48+30	20	5.997 €
	VSF-GG-1 014	1/2	230 V-I	24	60	2134	1500	2,55	0,99	13,5	1100	1700	1/4"-1/2"	< 2,5	59+42	20	6.833 €
	VSF-GG-1 024	1	230 V-I	47	100	3388	3000	4,81	1,71	24,9	1800	1700	3/8"-5/8"	< 10,0	82+52	24	8.226 €
	VSF-GG-1 034	1 1/2	230 V-I *	75	170	4944	3000	5,55	2,44	29,9	1800	3200	3/8"-5/8"	< 10,0	83+52	29	9.621 €
	VSF-GG-2 048	2	400 V-III	151	300	7830	6000	9,19	2,98	17,9	3150	3700	1/2"-3/4"	< 10,0	84+75	30	12.999 €
VSF-GG-3 060	3	400 V-III	221	450	10490	6000	10,87	4,66	19,5	5200	6500	1/2"-7/8"	< 10,0	88+75	29	14.855 €	

- Opcionales**
- Cambio a alimentación 400 V-III-50 Hz. * + 5%
 - Refrigerante R452A. + 0%

Dimensiones evaporador

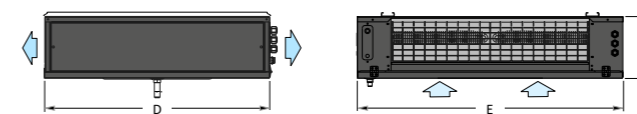

Dimensiones condensador

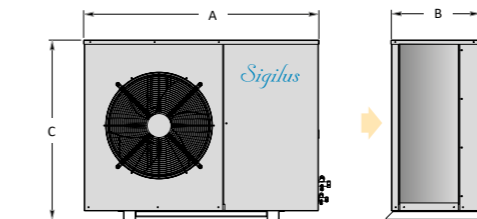

Dimensiones (mm)	A	B	C	D	E	F	Ventiladores evaporador
serie 0 y 00	670	305	440	738	627	203	1x Ø 254
serie 10	1030	373	577	738	627	203	1x Ø 254
serie 11 y VSF-GG-1014	1030	373	577	860	706	253	1x Ø 360
serie 12 y VSF-GG-1024 y 1034	1030	373	577	860	1056	253	2x Ø 360
serie 2 y 23	1080	410	827	860	1756	253	3x Ø 360
serie 3 y 33	1150	481	1097	860	1756	253	3x Ø 360

- Otros refrigerantes. Consultar⁽¹⁾ Las prestaciones nominales están referidas al funcionamiento con temperatura de cámara de 15°C, humedad relativa de cámara del 70% y temperatura exterior de 35°C. Volumen de cámara para hostelería estimado sin aislar y volumen de bodega estimado con aislamiento de 30 mm.

⁽²⁾ Potencia absorbida nominal en modo de deshumectación.

⁽³⁾ Potencia absorbida nominal en modo de refrigeración.

⁽⁴⁾ Nivel sonoro referido a nivel de presión acústica en dB(A), medido en campo abierto a 10 m de distancia de la fuente.

* Unidades disponibles en tensión 400 V-III-50 Hz.

Versión centrífuga, serie VSH-CG
Los equipos para bodegas se encuentran también disponibles en versión con condensadora centrífuga.

SERIE / MODELO	CV	CAUDAL COND. (m ³ /h)	P.E.D. ⁽⁵⁾ (mmca)	PVP (€)	
R134a	VSH-CGY-10 010	3/8	575	12	5.800 €
	VSH-CGY-21 015	1/2	1000	6,5	7.251 €
	VSH-CGY-22 033	1	1000	6,5	8.728 €
	VSH-CGY-33 053	1 1/2	1500	14	10.808 €
	VSH-CGY-43 074	2	3500	10	14.254 €
R449A	VSH-CGG-2 014	1/2	1000	6,5	6.833 €
	VSH-CGG-2 024	1	1000	6,5	8.226 €
	VSH-CGG-3 034	1 1/2	1500	14	9.621 €
	VSH-CGG-4 048	2	3500	10	12.999 €
	VSH-CGG-4 060	3	3500	10	14.855 €

⁽⁵⁾ Presión estática disponible en conductos de expulsión.

Características técnicas y constructivas sujetas a variación sin previo aviso.

We reserve the right to change specifications without prior notice.

