

**TECNOLOGÍA,  
CALIDAD  
Y SOSTENIBILIDAD**  
TECHNOLOGY, QUALITY & SUSTAINABILITY  
TECHNOLOGIE, QUALITÉ ET DURABILITÉ

Junio 2023

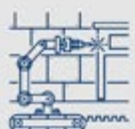
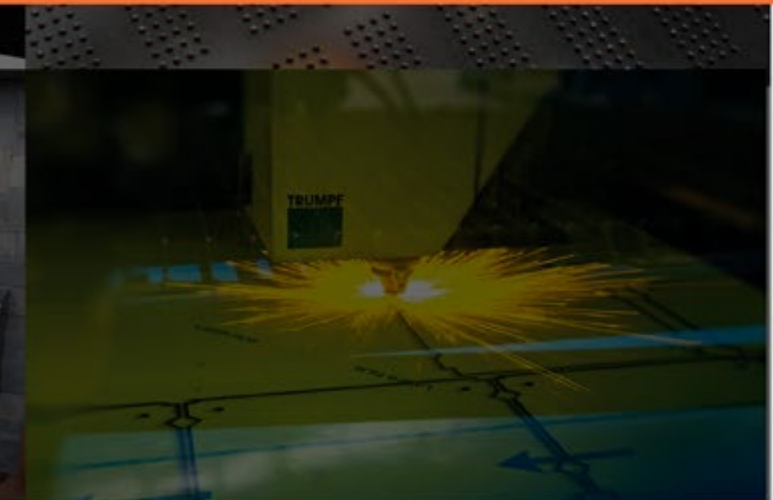

## **PROHIBIDA LA REPRODUCCIÓN TOTAL O PARCIAL DE ESTE CATÁLOGO**

NOTA: La información que les facilitamos en este catálogo, tanto en precios, modelos, dimensiones y características, no nos obliga a mantenerlos y pueden ser modificados sin previo aviso.

Algunas de las imágenes mostradas en este catálogo han sido creadas digitalmente y pueden variar de la realidad.

NOTE: All the information in this catalogue, whether it be prices, models, dimensions or characteristics is subject to change without notice.

Some of the images shown in this catalogue were created digitally and can vary from reality.

NOTE: L'information que nous vous donnons dans ce catalogue relative aux prix, aux modèles, aux dimensions et aux caractéristiques ne nous oblige pas à maintenir ces derniers; c'est pourquoi, ils peuvent subir des modifications.

Certaines images montrées dans ce catalogue ont été créés numériquement et peuvent varier de la réalité.



La historia de FRICOSMOS, S.A. comenzó en el año 1985 representando la continuidad de una saga familiar cuyos orígenes se remontan a 1.960, año en el que se creó la empresa Inoxidables Sanz León que fabricaba productos de herraje y de cuchillería.

38 años después aquella empresa ha crecido, obteniendo el reconocimiento de más de 7.000 distribuidores en todo el mundo. Esta difícil andadura la hemos recorrido gracias a un equipo de profesionales que han creído en este proyecto empresarial, trabajando con ilusión, la ilusión que nos sigue impulsando a seguir creciendo y a responder con garantías los retos que plantea este nuevo contexto competitivo.

FRICOSMOS, S.A., en su larga tradición por la calidad obtuvo la certificación ISO 9001 en el año 2002, actualizada en este momento a la versión 2008. Este certificado es el reconocimiento de la madurez y eficacia de nuestro sistema de calidad y confirma la voluntad de la empresa de desarrollar una línea de progreso continuo, en la que dar cada día una respuesta más ajustada a las necesidades de nuestros clientes.

Durante todos estos años hemos unido nuestra tecnología de vanguardia a materiales de primera calidad, para obtener unos productos típicamente artesanos y de calidad garantizada, cumpliendo todos los estándares y normativas europeas aplicables. Todos nuestros productos se diseñan teniendo en cuenta los requisitos legales, lo que es de gran ayuda para sus clientes en la implantación de un Sistema de Gestión de Calidad Alimentaria APPCC (Análisis de Peligros y Puntos de Control Crítico), HACCP en terminología sajona.

Este catálogo se ha diseñado y realizado pensando en las necesidades de nuestros clientes; es por ello por lo que, en nuestro espíritu de mejora continua, estudiaremos cuantas sugerencias de mejora acerca del mismo podamos recibir, y así adecuarlo en próximas ediciones.



The story of Fricosmos began in the year 1985. It represents the continuity of a long dynasty which origins goes back to the year 1960, year when the firm Inoxidables Sanz León, was founded as an ironworks and knives manufacturing company.

38 years later the company has grown giving as a result a firm with the recognition of more than 7.000 distributors all over the world. This long progress has been achieved thanks to a team of professionals that believe in this business project, working together as a group with a will that encourages us to keep on growing and rising up our level within this so competitive context.

Fricosmos, S.A., continuing its long tradition of quality, obtained the certified ISO 9001 in the year 2002, now updated to its version 2008. This certified is the recognition to the efficiency and maturity of our quality system, and confirms the purpose of our firm for the development of a straight line of continuous progress, giving day after day the most suitable response to our customers' needs.

Throughout all these years we have combined our innovative technology and materials of the highest standards to obtain a typically handicraft product with a guaranteed quality that accomplishes all the norms of the European current regulations. Every one of our products is conceived in accordance to all legal requirements, so that they can be helpful for your customers when adopting the Food Quality Management System HACCP (Hazard Analysis and Critical Control Point).

This catalogue has been designed and carried out thinking on our customer demands. For this reason and true to our will of continuous improvement, we will study thoroughly every suggestion we receive concerning it for its adequacy to our clients' needs in next editions.



L'histoire de Fricosmos commença en 1985 et représente la continuité d'une longue dynastie familiale dont ses origines remontent à 1960. Cette date est l'année de création de l'entreprise Inoxidables Sanz León qui fabriquait de la ferrure et de la coutellerie.

38 ans après, cette société-là est grandie et a obtenu la reconnaissance de plus de 7.000 distributeurs tout autour du monde. Ce long chemin a été possible grâce à une équipe de professionnels qui ont cru à ce projet et qui travaillent ensemble avec une volonté qui nous encourage à continuer à croître et à répondre aux défis de ce nouveau contexte si compétitif.

Fricosmos, S.A. a obtenu la certification ISO 9001 en 2002, actualisée en ce moment à la version 2008. Ce certificat éprouve l'efficacité et l'expérience de notre système de qualité en confirme la volonté de la société pour développer une ligne de progrès constant et pour offrir chaque jour une réponse adaptée au maximum aux besoins de nos clients.

Au cours des années, nous avons allié une technologie d'avant-garde aux matériaux de première qualité afin d'obtenir des produits exclusivement artisanaux d'une qualité garantie qui respectent les réglementations européens applicables. Tous les produits de Fricosmos sont conçus pour respecter les exigences légales ce qui sera d'une grande utilité pour vos clients à développer le système de gestion de la qualité alimentaire HACCP (Hazard Analysis and Critical Control Point).

Pour concevoir et réaliser ce catalogue, nous avons pensé aux besoins de nos clients, c'est pour cela que, dans notre intention d'amélioration continue, nous étudierons toutes les suggestions que nous recevrons afin d'adapter au maximum ce catalogue à votre utilisation.



Calle Cámara de la Industria, 11A  
Polígono industrial nº 1  
28938 MÓSTOLES (Madrid) ESPAÑA  
[www.fricosmos.com](http://www.fricosmos.com)



Capture el código desde su dispositivo móvil a través de su aplicación lectora de QR-Codes.

Capture the code from your mobile device through your reader application QR-Codes.

Capturez le code de votre appareil mobile via votre application lecteur de QR-Codes.

 +34 916 852 130

 +34 638 271 889



[facebook.com/fricosmos](https://facebook.com/fricosmos)



[twitter.com/fricosmos](https://twitter.com/fricosmos)



[youtube.com/fricosmos](https://youtube.com/fricosmos)



[linkedin.com/company/fricosmos/](https://linkedin.com/company/fricosmos/)



# LEYENDA

## SYMBOLS SYMBLES

L H H1 Dimensiones en milímetros.  
Dimensions in millimeters.  
Dimensions en millimètres.

H2 H3 A

D D1 D2

E E1 E2

F I I1

h h1 h2

a a1 a2

d



Altura máxima en milímetros.  
Maximum height in millimeters.  
Hauteur maximale en millimètres.



Altura mínima en milímetros.  
Minimum height in millimeters.  
Hauteur minimale en millimètres.



Peso neto en kilogramos.  
Net weight in kilograms.  
Poids net en kilogrammes.



Peso neto en gramos.  
Net weight in grams.  
Poids net en grammes.



Código de producto.  
Product Code.  
Code de produit.



Colores disponibles.  
Available colors.  
Couleurs disponibles.



No son necesarias herramientas para el montaje del producto.  
No tools required for assembly of the product.  
Aucun outil requis pour l'assemblage du produit.



Diámetro en milímetros.  
Diameter in millimeters.  
Diamètre en millimètres.



Producto adaptado para lavavasos.  
Product suitable for glasswashers.  
Produit apte pour lave-verres.



Producto adaptado para lavaplatos.  
Product suitable for dishwasher.  
Produit apte pour lave-vaisselle.



Caudal de agua en litros por minuto.  
Water flow rate in liters per minute.  
Débit d'eau en litres par minute.



Temperatura máxima en grados centígrados.  
Maximum temperature in degrees Celsius.  
Température maximale en degrés Celsius.



Alcance máximo.  
Maximum reach.  
Portée maximum.



Capacidad en litros.  
Capacity in liters.  
Capacité en litres.



Peso máximo soportado.  
Maximum load capacity.  
Capacité de charge maximale.



Unidades contenidas en la caja o bolsa.  
Units contained per box or bag.  
Unités contenus par boîte ou sac.



Revoluciones por minuto.  
Revolutions per minute.  
Tours par minute.



Accesorio incluido en el producto.  
Accessories included with the product.  
Accessoires inclus avec le produit.



Accesorio no incluido en el producto.  
Accessories not included with the product.  
Accessoires non inclus avec le produit.



Número de soportes.  
Number of supports.  
Nombre de supports.



Orientación de desagüe.  
Drain position.  
Position d'égouttoir.



Número de huecos.  
Number of holes.  
Nombre de trous.



Número de puertas abatibles.  
Number of hinged doors.  
Nombre de portes battantes.



Número de puertas corredera.  
Number of sliding doors.  
Nombre de portes coulissantes.



Tipo de conexión eléctrica.  
Type of electrical connection.  
Type de connexion électrique.



Producto muy pesado.  
Very heavy product.  
Produit très lourd.



Normativa internacional Gastronorm.  
Gastronorm international standards.  
Norme internationale Gastronorm.



Producto adaptado en altura para cocinas serie snack o modular.  
Product height adapted to modular or snack bar kitchens.  
Hauteur du produit adapté aux cuisines modulaires ou de restauration rapide.



Preste especial atención.  
Pay special attention.  
Prêtez particulière attention.



Ampliar información en la página.  
More information on page.  
Plus d'informations à la page.



Únicamente los productos con este logotipo cumplen con la certificación NSF.  
Only products with this logo meet NSF certification.  
Seulement les produits avec ce logo sont conformes aux certifications NSF.



## **ESTANTERÍAS Y ESTANTES**

SHELVING AND SHELVES  
RAYONNAGES ET ÉTAGÈRES

7



## **HERRAJES**

HOOKS AND STAINLESS STEEL FIXTURES  
FERRURES ET CROCHETS

39



## **TAJOS DE TROCEO Y FIBRAS DE CORTE**

CHOPPING BLOCKS AND FIBRE BOARDS  
BILLOTS DE DÉCOUPAGE ET PLAQUES

67



## **CUCHILLERÍA PROFESIONAL**

PROFESSIONAL KNIVES  
COUTELLERIE PROFESIONNELLE

87



## **LAVAMANOS**

WASHBASINS  
LAVE-MAINS

179



## **FUENTES DE AGUA**

DRINKING FOUNTAINS  
SOURCES D'EAU

203



## **FREGADEROS**

SINKS  
ÉVIERS

215



## **GRIFERÍA**

TAPS AND FITTINGS  
ROBINETTERIE

241



## **MOBILIARIO**

FURNITURE  
MEUBLES

283



## **SEGURIDAD E HIGIENE**

HEALTH AND SAFETY  
SÉCURITÉ ET SANTÉ AU TRAVAIL

353



## **COMPLEMENTOS**

COMPLEMENTS  
COMPLÉMENTS

431



## **INDICE ANALITICO / CONDICIONES GENERALES**

ANALYTICAL TABLE OF CONTENTS / GENERAL CONDITIONS  
INDEX ANALYTIQUE / CONDITIONS GÉNÉRALES

501



ER-0332/2002



Fricosmos,S.A. contribuye a la conservación del Medio Ambiente mediante su aportación al sistema de separación, retirada y reciclado de nuestros envases con el sistema Ecoembes identificado con el punto verde.

Fricosmos, S.A. contributes to the preservation of the environment through its contribution to the procedure of selection, removal and recycling of our packages following the Ecoembes system identified with the green point.

Fricosmos, S.A. participe de la préservation de l'environnement moyennant sa contribution au procédé de sélection, retirée et recyclage de nos emballages selon le système Ecoembes identifié avec le point vert.



Registro sanitario  
nº 39.2737 / M







# ESTANTERIAS Y ESTANTES

SHELVING AND SHELVES  
RAYONNAGES ET ÉTAGÈRES

**NOVEDADES**  
NEWS  
NOUVEAUTÉS



19



19

# Estanterías modulares

Modular shelving  
Rayonnages modulaires

## Características de fabricación:

Construidas totalmente en acero inoxidable, acabado satinado.

Doble pliegue con pestaña aplastada en los estantes, para evitar cortes y ganar resistencia.

Fácil montaje.

Gran diversidad de medidas para una máxima adaptación a su lugar de colocación.

Alturas disponibles desde 850 mm, para su utilización como mesas de apoyo, carros, etc., hasta 2950 mm para el mejor aprovechamiento del espacio.

Dos espesores de chapa disponibles y con la opción de poder solicitarlas con refuerzos soldados en su base, ver página 11.

Se puede regular la altura entre estante y estante cada 100 mm, con posibilidad de poner un estante a ras de suelo.

Pies regulables para una mayor estabilidad en cualquier suelo.

Posibilidad de colocación de ruedas, ver página 497.

Opcionalmente se pueden suministrar con kit de pletinas. Ver página 11.

## Manufacturing characteristics:

Made totally in stainless steel shiny finished. Double fold with crushed fringe in shelves, to avoid any bad cut and to increase the resistance.

Easy mounting.

Great diversity of measures to allow a maximum fitting to the mounting room. Available heights from 850 mm for its usage as auxiliar tables, charts, etc. up to 2950 mm for the best use of the room.

Sheet thick available in two measures with the option of order them with reinforcements fixed at its base. See page 11.

Height adjustment every 100 mm, with the possibility of mounting one shelf at the ground level.

Adjustable feet to allow a higher stability on any floor.

Possibility of fixing wheels. See page 497. They can be supplied optionally with plates and hooks. See page 11.

## Caractéristiques de fabrication:

Construit totalement en acier inoxydable finition satinée. Double pli avec rebord aplati pour éviter des coupures et gagner en résistance.

Facilité de montage.

Grand diversité de mesures pour une maxime adaptation a l'endroit de installation.

Hauteur disponibles depuis 850 mm pour l'utilisation comme tables auxiliaires, chariots, etc, jusqu'à 2950 mm pour le mieux profit de l'espace.

Deux épaisseurs de tôle disponibles avec l'option de les solliciter avec renforcements soudés dans sa base. Voir page 11.

Hauteur réglable tous les 100 mm, avec la possibilité de monter une étagère au niveau du sol.

Pieds réglables pour une plus grande stabilité dans n'importe quel sol.

Possibilité de montage de rouelles. Voir page 497.

Optionnellement elles peuvent être fournies avec un kit de platines et crochets. Voir page 11.

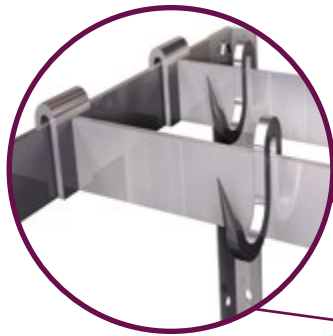

Detalle de kit de pletinas acoplado a estantería.

Detail of plates set coupled in shelving.  
Détail de kit de pletines accouplé dans le rayonnage.



Posibilidad de acoplar cajones a estantes.

Drawer coupled possibility.  
Possibilité de tiroir accouplé.

493

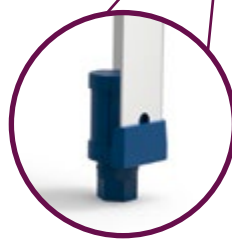

Detalle del pie del soporte de estantería.

Detail of shelving support base.  
Détail du pied du support de rayonnage.



Posibilidad de acoplar ruedas a soportes de estantería.

Castor fixed to shelving supports possibility.  
Possibilité de rouelle accouplée dans supports de rayonnage.

## Estanterías modulares con estantes lisos

Modular shelving with non-perforated shelves  
Rayonnages modulaires avec étagères lisses

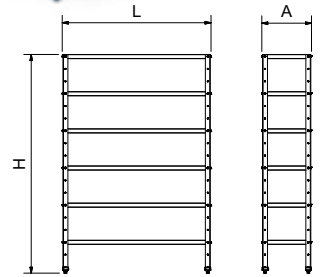

Estos precios incluyen estantes, soportes, tornillos y tuercas.  
Shelves, shelving supports, nuts and bolts included in these prices.  
Étagères, supports de rayonnage et vis à écrou compris dans ces prix.

				Número de estantes Number of shelves Numéro d'étagères							
				3		4		5		6	
L	A	H	Estante de Strength per Étagère par	Barcode	€	Barcode	€	Barcode	€	Barcode	€
800	300	1.750	0,8 mm	910060402	<b>241,68</b>	910060302	<b>278,24</b>	910060202	<b>314,80</b>	910060102	<b>351,36</b>
			1,5 mm	910060902	<b>289,68</b>	910060602	<b>342,24</b>	910060702	<b>394,80</b>	910060802	<b>447,36</b>
1.000	300	1.750	0,8 mm	910060404	<b>253,68</b>	910060304	<b>294,24</b>	910060204	<b>334,80</b>	910060104	<b>375,36</b>
			1,5 mm	910060904	<b>334,68</b>	910060604	<b>402,24</b>	910060704	<b>469,80</b>	910060804	<b>537,36</b>
1.200	300	1.750	0,8 mm	910060406	<b>277,68</b>	910060306	<b>326,24</b>	910060206	<b>374,80</b>	910060106	<b>423,36</b>
			1,5 mm	910060906	<b>373,68</b>	910060606	<b>454,24</b>	910060706	<b>534,80</b>	910060806	<b>615,36</b>
1.400	300	1.750	0,8 mm	910060408	<b>295,68</b>	910060308	<b>350,24</b>	910060208	<b>404,80</b>	910060108	<b>459,36</b>
			1,5 mm	910060908	<b>412,68</b>	910060608	<b>506,24</b>	910060708	<b>599,80</b>	910060808	<b>693,36</b>
800	400	1.750	0,8 mm	910060410	<b>253,68</b>	910060310	<b>294,24</b>	910060210	<b>334,80</b>	910060110	<b>375,36</b>
			1,5 mm	910060910	<b>337,68</b>	910060610	<b>406,24</b>	910060710	<b>474,80</b>	910060810	<b>543,36</b>
1.000	400	1.750	0,8 mm	910060412	<b>277,68</b>	910060312	<b>326,24</b>	910060212	<b>374,80</b>	910060112	<b>423,36</b>
			1,5 mm	910060912	<b>376,68</b>	910060612	<b>458,24</b>	910060712	<b>539,80</b>	910060812	<b>621,36</b>
1.200	400	1.750	0,8 mm	910060414	<b>295,68</b>	910060314	<b>350,24</b>	910060214	<b>404,80</b>	910060114	<b>459,36</b>
			1,5 mm	910060914	<b>415,68</b>	910060614	<b>510,24</b>	910060714	<b>604,80</b>	910060814	<b>699,36</b>
1.400	400	1.750	0,8 mm	910060416	<b>325,68</b>	910060316	<b>390,24</b>	910060216	<b>454,80</b>	910060116	<b>519,36</b>
			1,5 mm	910060916	<b>460,68</b>	910060616	<b>570,24</b>	910060716	<b>679,80</b>	910060816	<b>789,36</b>
800	500	1.750	0,8 mm	910060418	<b>277,68</b>	910060318	<b>326,24</b>	910060218	<b>374,80</b>	910060118	<b>423,36</b>
			1,5 mm	910060918	<b>376,68</b>	910060618	<b>458,24</b>	910060718	<b>539,80</b>	910060818	<b>621,36</b>
1.000	500	1.750	0,8 mm	910060420	<b>295,68</b>	910060320	<b>350,24</b>	910060220	<b>404,80</b>	910060120	<b>459,36</b>
			1,5 mm	910060920	<b>415,68</b>	910060620	<b>510,24</b>	910060720	<b>604,80</b>	910060820	<b>699,36</b>
1.200	500	1.750	0,8 mm	910060422	<b>325,68</b>	910060322	<b>390,24</b>	910060222	<b>454,80</b>	910060122	<b>519,36</b>
			1,5 mm	910060922	<b>460,68</b>	910060622	<b>570,24</b>	910060722	<b>679,80</b>	910060822	<b>789,36</b>
1.400	500	1.750	0,8 mm	910060424	<b>343,68</b>	910060324	<b>414,24</b>	910060224	<b>484,80</b>	910060124	<b>555,36</b>
			1,5 mm	910060924	<b>505,68</b>	910060624	<b>630,24</b>	910060724	<b>754,80</b>	910060824	<b>879,36</b>
800	600	1.750	0,8 mm	910060426	<b>295,68</b>	910060326	<b>350,24</b>	910060226	<b>404,80</b>	910060126	<b>459,36</b>
			1,5 mm	910060926	<b>415,68</b>	910060626	<b>510,24</b>	910060726	<b>604,80</b>	910060826	<b>699,36</b>
1.000	600	1.750	0,8 mm	910060428	<b>325,68</b>	910060328	<b>390,24</b>	910060228	<b>454,80</b>	910060128	<b>519,36</b>
			1,5 mm	910060928	<b>460,68</b>	910060628	<b>570,24</b>	910060728	<b>679,80</b>	910060828	<b>789,36</b>
1.200	600	1.750	0,8 mm	910060430	<b>343,68</b>	910060330	<b>414,24</b>	910060230	<b>484,80</b>	910060130	<b>555,36</b>
			1,5 mm	910060930	<b>505,68</b>	910060630	<b>630,24</b>	910060730	<b>754,80</b>	910060830	<b>879,36</b>
1.400	600	1.750	0,8 mm	910060432	<b>394,68</b>	910060332	<b>482,24</b>	910060232	<b>569,80</b>	910060132	<b>657,36</b>
			1,5 mm	910060932	<b>541,68</b>	910060632	<b>678,24</b>	910060732	<b>814,80</b>	910060832	<b>951,36</b>

## Estantes lisos para estanterías modulares

Flat shelves for modular shelving  
Étagères lisses pour rayonnages modulaires

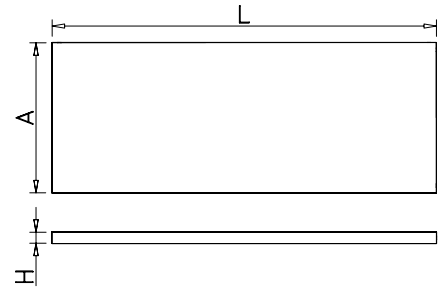

			Estantes de 0,8 mm 0,8 mm shelves Étagères 0,8 mm			Estantes de 1,5 mm 1,5 mm shelves Étagères 1,5 mm		
L	A	H	Kg	Barcode	€	Kg	Barcode	€
800	300	35	2,20	010202	<b>34,00</b>	4,16	010402	<b>50,00</b>
1.000	300	35	2,78	010204	<b>38,00</b>	5,14	010404	<b>65,00</b>
1.200	300	35	3,24	010206	<b>46,00</b>	6,02	010406	<b>78,00</b>
1.400	300	35	3,76	010208	<b>52,00</b>	7,02	010408	<b>91,00</b>
800	400	35	2,76	010210	<b>38,00</b>	5,32	010410	<b>66,00</b>
1.000	400	35	3,40	010212	<b>46,00</b>	6,30	010412	<b>79,00</b>
1.200	400	35	4,04	010214	<b>52,00</b>	7,71	010414	<b>92,00</b>
1.400	400	35	4,76	010216	<b>62,00</b>	9,00	010416	<b>107,00</b>
800	500	35	3,36	010218	<b>46,00</b>	6,16	010418	<b>79,00</b>
1.000	500	35	4,14	010220	<b>52,00</b>	7,68	010420	<b>92,00</b>
1.200	500	35	4,90	010222	<b>62,00</b>	9,12	010422	<b>107,00</b>
1.400	500	35	5,56	010224	<b>68,00</b>	10,58	010424	<b>122,00</b>
800	600	35	3,86	010226	<b>52,00</b>	7,30	010426	<b>92,00</b>
1.000	600	35	4,94	010228	<b>62,00</b>	8,98	010428	<b>107,00</b>
1.200	600	35	5,60	010230	<b>68,00</b>	10,70	010430	<b>122,00</b>
1.400	600	35	6,50	010232	<b>85,00</b>	12,34	010432	<b>134,00</b>

## Soportes de estantería

Shelving supports  
Supports de rayonnage



### Características:

Espesor del acero 2 mm.  
Admiten estante a nivel del suelo.  
Separación entre taladros de 100 mm.

### Characteristics:

Stainless steel thickness 2 mm.  
Shelf allowed at ground level.  
Holes are 100 mm apart.

### Caractéristiques:

Acier inoxydable épaisseur 2 mm.  
Étagère admise au niveau du sol.  
Ecart des trous tous les 100 mm.

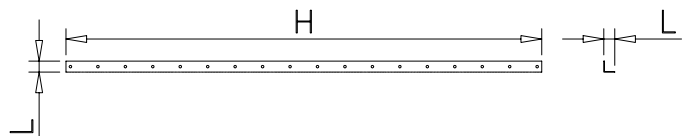

H	L	Kg	Barcode	€
850	40x40	1,05	011002	<b>21,00</b>
1.050	40x40	1,24	011004	<b>22,00</b>
1.450	40x40	1,62	011006	<b>31,00</b>
1.750	40x40	2,02	011008	<b>33,00</b>
2.050	40x40	2,38	011010	<b>36,00</b>
2.350	40x40	2,58	011012	<b>46,00</b>
2.950	40x40	2,69	011014	<b>58,00</b>

## Refuerzos soldados a estantes

Welded reinforcements for shelves  
Renforts soudés aux étagères



### Características:

Aumentan la capacidad de carga. Ver página 12

Characteristics:  
Increase the load-capacity. See the page 12

Caractéristiques:  
Il sert à améliorer la capacité de chargement. Voir page 12

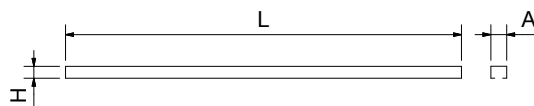

L	A	H	Kg	Barcode	€
800	40	30	1,02	011202	<b>20,00</b>
1.000	40	30	1,18	011204	<b>25,00</b>
1.200	40	30	1,41	011206	<b>27,00</b>
1.400	40	30	1,65	011208	<b>29,00</b>

## Tornillos y tuercas para estantes

Nut and bolt for shelves  
Vis à écrou pour étagères

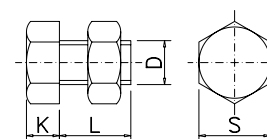

### Tornillo para unión de estanterías.

Screw for shelving units union.  
Vis pour union d'étagères.

8 tornillos y tuercas por estante.  
8 nut and bolt for shelf.  
8 vis et écroux pour étagère.

	D	L	S	K	Gr	Barcode	€
Tornillo Bolt Vis	M8	12	13	5,3	7,00	421012	<b>0,20</b>
Tornillo Bolt Vis	M8	25	13	5,3	11,00	421016	<b>0,25 *</b>
Tuerca Nut Écrou	M8		13	5,3	4,00	421056	<b>0,12</b>

## Kit de pletinas para estanterías

Plate kit for shelves  
Kit de platines pour rayonnages



### Dotación de cada kit de pletinas:

Una pletina de la medida del largo de la estantería, con una "U" soldada a cada extremo. Dos pletinas de la medida del ancho de la estantería preparadas para atornillar a los soportes. Tornillería.

Each plate kit consists of:  
One plate of the same length as the shelves with a U-shaped bracket welded to either end. Two plates of the same width as the shelves ready to be bolted to the supports. Nuts and bolts.

Dotation de chaque kit de platines:  
Une platine mesurant la largeur de l'étagère avec deux "U" soudés à chaque extrémité. Deux platines mesurant la largeur de l'étagère conçues pour être vissées aux supports. Visserie.

L	A	Kit 1 Pletina One plate kit Kit de 1 platine		Pletina Opcional Optional plate Platine en option	
		Barcode	€	Barcode	€
800	300	012802	<b>163,00</b>	012850	<b>78,00</b>
	400	012810	<b>177,00</b>		
	500	012818	<b>190,00</b>		
	600	012826	<b>203,00</b>		
1.000	300	012804	<b>173,00</b>	012852	<b>87,00</b>
	400	012812	<b>190,00</b>		
	500	012820	<b>203,00</b>		
1.200	600	012828	<b>214,00</b>	012854	<b>96,00</b>
	300	012806	<b>186,00</b>		
	400	012814	<b>203,00</b>		
	500	012822	<b>214,00</b>		
1.400	600	012830	<b>224,00</b>	012856	<b>105,00</b>
	300	012808	<b>198,00</b>		
	400	012816	<b>214,00</b>		
	500	012824	<b>225,00</b>		
	600	012832	<b>236,00</b>		

## Resistencia de carga por estante

Load strength

Résistance de charge par étagère



Las cargas se consideran uniformemente repartidas en la superficie del estante.

It is assumed that loads are evenly distributed on the shelf surface.  
On considère que les charges sont réparties uniformément sur la surface de l'étagère.

Dimensiones Dimensions Dimensions	Estante de Strength per Étagère par	Sin refuerzos Without reinforcement Sans renforts	1 refuerzo 1 reinforcement 1 Renforts	2 refuerzos 2 reinforcement 2 Renforts	3 refuerzos 3 reinforcement 3 Renforts
800x300	0,8 mm	225	275	325	
	1,5 mm	300	350	400	
1.000x300	0,8 mm	175	225	275	
	1,5 mm	250	300	375	
1.200x300	0,8 mm	125	150	200	
	1,5 mm	150	200	275	
1.400x300	0,8 mm	100	125	175	
	1,5 mm	125	175	225	
800x400	0,8 mm	200	250	300	350
	1,5 mm	275	325	375	475
1.000x400	0,8 mm	150	200	250	300
	1,5 mm	225	275	350	450
1.200x400	0,8 mm	100	125	175	225
	1,5 mm	125	175	250	350
1.400x400	0,8 mm	75	100	150	200
	1,5 mm	100	150	200	300
800x500	0,8 mm	200	250	300	350
	1,5 mm	275	325	375	475
1.000x500	0,8 mm	150	200	250	300
	1,5 mm	225	275	350	450
1.200x500	0,8 mm	100	125	175	225
	1,5 mm	125	175	250	350
1.400x500	0,8 mm	75	100	150	200
	1,5 mm	100	150	200	300
800x600	0,8 mm	175	225	275	325
	1,5 mm	250	300	350	450
1.000x600	0,8 mm	125	175	225	275
	1,5 mm	200	250	325	425
1.200x600	0,8 mm	75	100	150	200
	1,5 mm	100	150	225	325
1.400x600	0,8 mm	50	75	125	175
	1,5 mm	75	125	175	275

## Soporte de sobremesa y mural porta-cubetas Gastronorm

Worktop and wall fixed Gastronorm trays holder  
Support sur table et mural porte-cuveaux Gastronorm



### Characteristics:

Manufactured in stainless steel.  
For worktop or wall mounted use (screws included).  
It can lodge Gastronorm containers up to 200 mm depth.  
You can carry out numerous combinations depending on your needs by using the dividing sections.  
Gastronorm containers and dividing sections not included.  
Lids and containers, see page 435.  
Dividing sections, see page 444.  
Standard handle for Gastronorm containers, see page 446.

### Caractéristiques:

Fabriqué en acier inoxydable.  
Il est conçu à poser sur table ou à accrocher au mur.  
Il peut loger des bacs Gastronorm jusqu'à 200 mm de profondeur.  
Vous pouvez réaliser des combinaisons nombreuses selon vos besoins en utilisant les sections de séparation.  
Bacs GN et des sections de séparation n'ont pas inclus.  
Couvercles et les récipients, voir page 435.  
Sections de séparation, voir page 444.  
Poignée standard pour récipients Gastronorm, voir page 446.

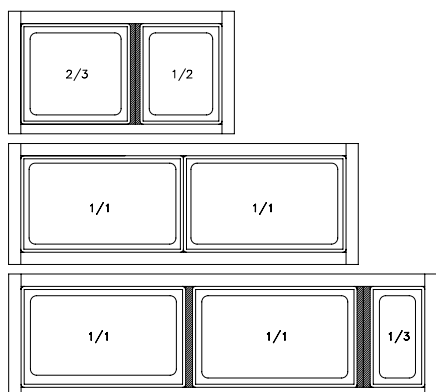

### Características:

Fabricado en acero inoxidable.  
Para uso de sobremesa o fijación mural (incluye tornillos para su fijación a la pared).  
Admite cubetas de hasta 200 mm de profundidad.  
Empleando los perfiles divisorios podrá ubicar numerosas combinaciones según sus necesidades.  
No incluye las cubetas ni los perfiles.  
Cubetas y tapas. Ver página 435.  
Perfiles divisorios. Ver página 444.  
Asa universal para cubetas. Ver página 446.

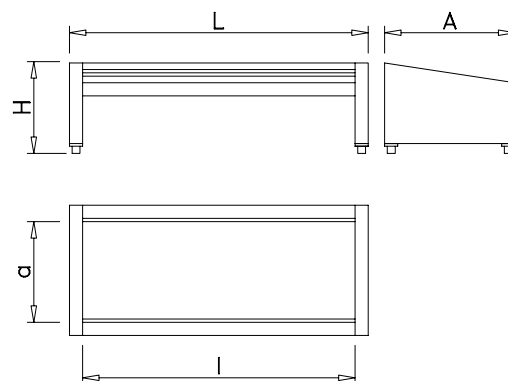

L	A	H	I	a	Kg	Barcode	€
740	390	275	655	325	6,0	082803	<b>169,00</b>
1.150	390	275	1.065	325	7,5	082804	<b>180,00</b>
1.390	390	275	1.305	325	8,5	082806	<b>212,00</b>

## Estantes murales cartelas modelo compacto

Fixed wall shelves  
Étagères murales modèle compact



**Characteristics:**  
The main characteristic of these shelves is that they are made in one only piece.

These shelves generally use our bolt code 421034 and our plug code 409824. See page 63.

**Caractéristiques:**  
La principale caractéristique de ces étagères est qu'elles sont fabriquées d'une seule pièce, dossier et postérieur.

Généralement, cet étagères utilisent notre vis code 421034 et notre cheville code 409824. Voir page 63.

### Características:

La principal característica de estos estantes es su construcción en una sola pieza.

Estos estantes se suelen atornillar a la pared con nuestro tornillo cód. 421034 y con el taco cód. 409824. Ver página 63.

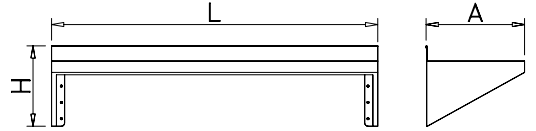

L	A	H	Kg	Barcode	€
1.000	300	245	5,76	011402	<b>118,00</b>
1.250	300	245	6,92	011404	<b>129,00</b>
1.500	300	245	8,08	011406	<b>163,00</b>
1.000	400	245	7,27	011408	<b>141,00</b>
1.250	400	245	8,73	011410	<b>171,00</b>
1.500	400	245	10,19	011412	<b>189,00</b>
1.000	500	245	8,78	011414	<b>166,00</b>
1.250	500	245	10,54	011416	<b>190,00</b>
1.500	500	245	12,30	011418	<b>213,00</b>



**Tornillos y tacos no incluidos en el precio.**  
Bolts and plugs not included in the price.  
Les vises et les chevilles ne sont pas inclus dans le prix.



## Estantes murales de tubo

Tube wall shelves  
Étagères murales en tube



These shelves generally use our bolt code 421034 and our plug code 409824. See page 63.

Généralement, cet étagères utilisent notre vis code 421034 et notre cheville code 409824. Voir page 63.

Estos estantes se suelen atornillar a la pared con nuestro tornillo cód. 421034 y con el taco cód. 409824. Ver página 63.

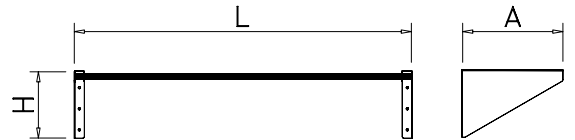

L	A	H	Kg	Barcode	€
750	300	200	4,00	011902	<b>113,00</b>
1.000	300	200	4,11	011904	<b>119,00</b>
750	400	200	4,80	011906	<b>126,00</b>
1.000	400	200	5,65	011908	<b>130,00</b>
750	500	200	5,88	011910	<b>158,00</b>
1.000	500	200	6,93	011912	<b>169,00</b>



**Tornillos y tacos no incluidos en el precio.**  
Bolts and plugs not included in the price.  
Les vises et les chevilles ne sont pas inclus dans le prix.

## Estante mural especial microondas

Wall shelf - specially for microwaves  
Étagère murale spéciale micro - ondes

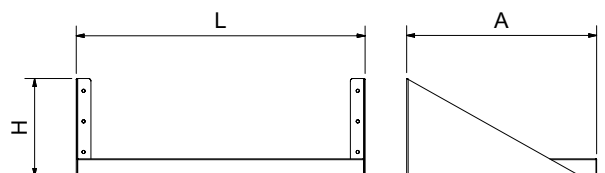

L	A	H	Kg	Barcode	€
590	388	200	3,00	015202	<b>102,00</b>



**Tornillos y tacos no incluidos en el precio.**  
Bolts and plugs not included in the price.  
Les vises et les chevilles ne sont pas inclus dans le prix.



## Estantes murales regulables imagine

Imagine adjustable wall shelves  
Étagères murales réglables imagine



Basados en las medidas internacionales GASTRONORM. Podrá intercambiar los estantes por recipientes, parrillas y fibras GN.

Based in the international standard GASTRONORM. You can replace the shelves for Gastronorm containers, grills and GN fibres.

Basé dans le standard international GASTRONORM. Vous pouvez remplacer les étagères pour les bacs, grilles GN et plaques GN.

Se instala con facilidad y rapidez. Los estantes se regulan a la altura deseada SIN HERRAMIENTAS, incluso su inclinación, 90° y 105°.

It can be mounted easily and quickly. Height and lean adjustment according to your needs WITHOUT TOOLS, 90° y 105°.

Installation facile et rapide. Réglage en hauteur et inclinaison selon vos besoins SANS OUTILS, 90° y 105°.

### Ejemplos de configuraciones:

Examples of configurations:  
Exemples de configurations:

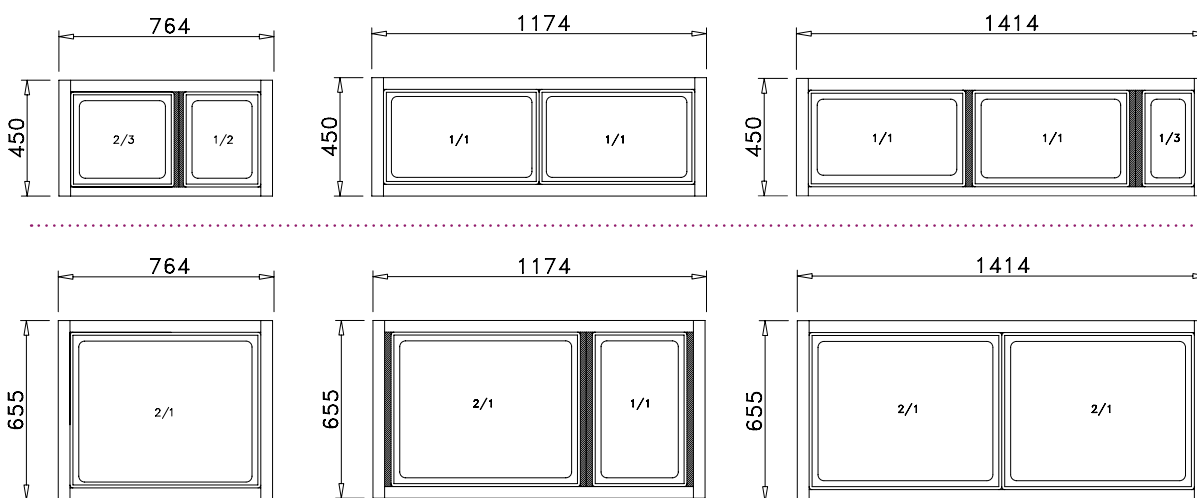

435 Op

Cubetas Gastronorm.  
Gastronorm trays.  
Cuveau gastronorm.

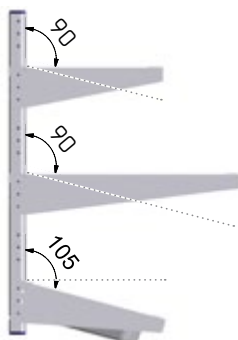
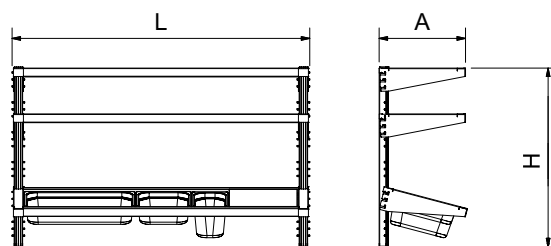

L	A	H	Barcode	€	Barcode	€	Barcode	€
764	413	860	910040102	264,00	910040202	400,00	910040302	536,00
1.174	413	860	910040104	292,00	910040204	456,00	910040304	620,00
1.414	413	860	910040106	330,00	910040206	532,00	910040306	734,00
764	614	860	910040108	286,00	910040208	444,00	910040308	602,00
1.174	614	860	910040110	324,00	910040210	520,00	910040310	716,00
1.414	614	860	910040112	362,00	910040212	596,00	910040312	830,00

## Estantes murales con cartelas

Wall shelves with brackets  
Étagères murales avec équères



Recta  
Upright bracket  
Équères droite

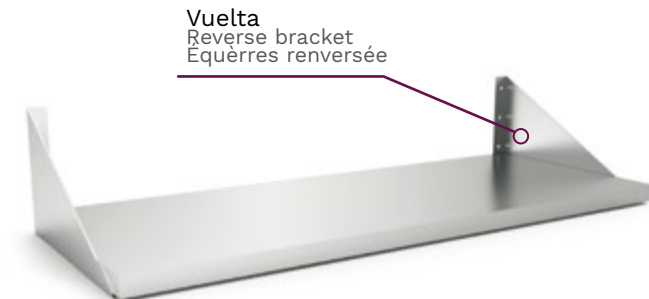

Vuelta  
Reverse bracket  
Équères renversée

Estos estantes se suelen atornillar a la pared con nuestro tornillo cód. 421034 y con el taco cód. 409824. Ver página 63.

These shelves generally use our bolt code 421034 and our plug code 409824. See page 63.

Généralement, ces étagères utilisent notre vis code 421034 et notre chevillé code 409824. Voir page 63.



Tornillos y tacos no incluidos en el precio.

Bolts and plugs not included in the price.  
Les vises et les chevilles ne sont pas inclus dans le prix.

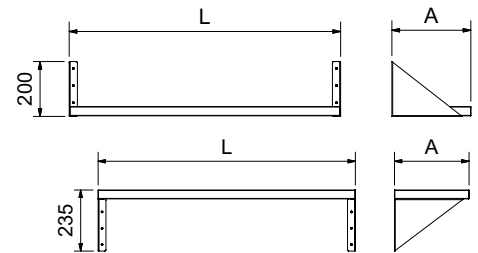

L	A			€
800	300	910080102	910080202	<b>89,00</b>
1.000	300	910080104	910080204	<b>96,00</b>
1.200	300	910080106	910080206	<b>102,00</b>
1.400	300	910080108	910080208	<b>111,00</b>
600	400	910080109	910080209	<b>102,00</b>
800	400	910080110	910080210	<b>103,00</b>
1.000	400	910080112	910080212	<b>111,00</b>
1.200	400	910080114	910080214	<b>118,00</b>
1.400	400	910080116	910080216	<b>121,00</b>
800	500	910080118	910080218	<b>127,00</b>
1.000	500	910080120	910080220	<b>133,00</b>
1.200	500	910080122	910080222	<b>141,00</b>
1.400	500	910080124	910080224	<b>145,00</b>
800	600	910080126	910080226	<b>144,00</b>
1.000	600	910080128	910080228	<b>147,00</b>
1.200	600	910080130	910080230	<b>157,00</b>
1.400	600	910080132	910080232	<b>160,00</b>

## Estantes murales

Wall shelves  
Étagères murales

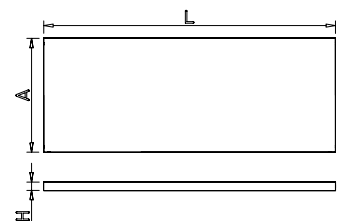

L	A	H	Kg		€
800	300	35	2,20	011602	<b>55,00</b>
1.000	300	35	2,78	011604	<b>62,00</b>
1.200	300	35	3,24	011606	<b>68,00</b>
1.400	300	35	3,76	011608	<b>77,00</b>
600	400	35	2,50	011609	<b>64,00</b>
800	400	35	2,76	011610	<b>65,00</b>
1.000	400	35	3,40	011612	<b>73,00</b>
1.200	400	35	4,04	011614	<b>80,00</b>
1.400	400	35	4,76	011616	<b>83,00</b>
800	500	35	3,36	011618	<b>81,00</b>
1.000	500	35	4,14	011620	<b>87,00</b>
1.200	500	35	4,90	011622	<b>95,00</b>
1.400	500	35	5,56	011624	<b>99,00</b>
800	600	35	3,95	011626	<b>98,00</b>
1.000	600	35	4,85	011628	<b>101,00</b>
1.200	600	35	5,75	011630	<b>111,00</b>
1.400	600	35	6,65	011632	<b>114,00</b>

## Cartelas para estantes murales

Brackets for wall shelves  
Équerres pour étagères murales

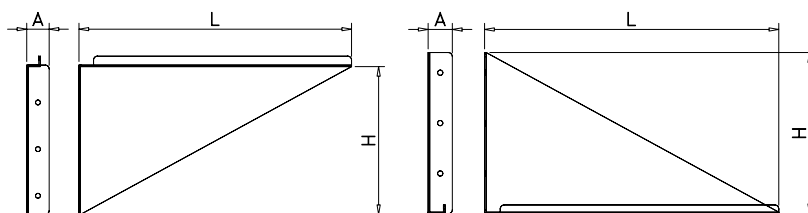
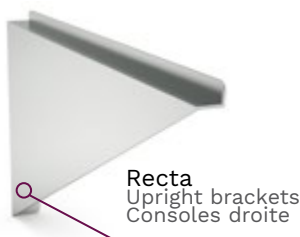

L	A	H	Gr	Barcode 1	Barcode 2	Barcode 3	Barcode 4	€
265	20	200	500	012402	012403	012602	012603	<b>17,00</b>
365	20	200	700	012404	012405	012604	012605	<b>19,00</b>
465	20	200	850	012406	012407	012606	012607	<b>23,00</b>

## Estantes de suelo

Floor shelves  
Étagères au sol

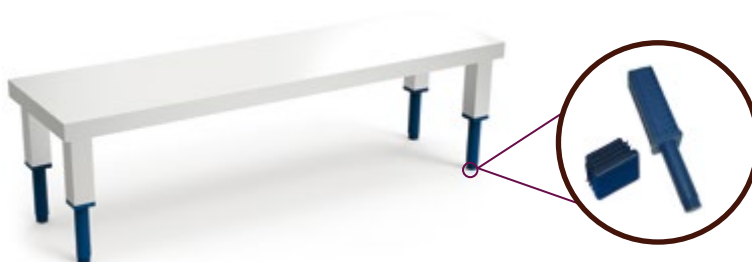

Diseñados para lugares donde no se permite el almacenamiento directamente en el suelo.

También válidos para mejorar la exposición de las carnes y embutidos dentro de los mostradores frigoríficos estándar. Su diversidad de medidas facilitan su adaptación a cualquier modelo de expositor. Construidos en chapa de acero inoxidable que, además de garantizar al máximo su duración, es totalmente higiénico y favorece la distribución del frío. Provistos de pies regulables en altura.

Intended for places where storage directly on the floor is not allowed.

Also valid for improve the display of meat and sausage on the stands of standar fridges. Its diversity of sizes make easier the adaptation at any model of stand. Constructed in stainless steel sheet that guarantees the maximum lenght and furthermore favours the cold distribution.

Fabriquées pour les lieux où le stockage directement au sol n'est pas permis.

Valables également pour améliorer l'exposition des viandes et des charcuteries dans les comptoirs frigorifiques standard. Sa diversité de dimensions facilitent sa adaptation a quelque modèle de comptoir. Construit en plaque d'acier inoxydable, laquel en plus de garantir au maximum sa durée, c'est totalement hygiénique et favorise la distribution du froid. Pourvu de pieds réglables en hauteur.

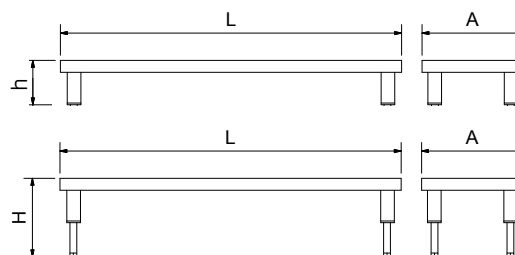

L	A	H <sub>1</sub>	H <sub>2</sub>	Kg	Barcode	€
800	300	130	230	2,8	082002	<b>148,00</b>
1.000	300	130	230	3,4	082004	<b>154,00</b>
1.200	300	130	230	3,9	082006	<b>160,00</b>
1.400	300	130	230	4,4	082008	<b>175,00</b>
600	400	130	230	2,8	082018	<b>114,00</b>
800	400	130	230	3,4	082010	<b>160,00</b>
1.000	400	130	230	4,0	082012	<b>171,00</b>
1.200	400	130	230	4,7	082014	<b>175,00</b>
1.400	400	130	230	5,4	082016	<b>196,00</b>

## Estante mural porta-barquetas

Wall shelf for meat plastic trays

Étagère murale porte-barquettes alimentaires

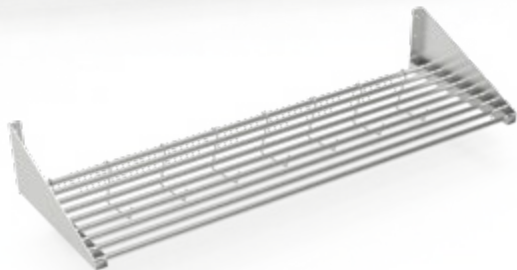
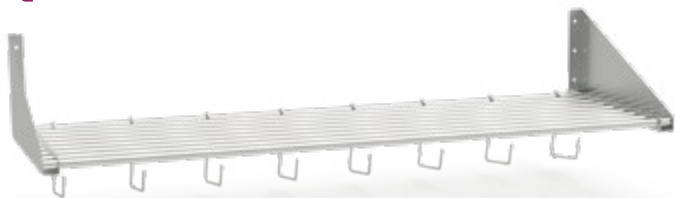

Estos estantes se suelen atornillar a la pared con nuestro tornillo cód. 421034 y con el taco cód. 409824. Ver página 63.

These shelves generally use our bolt code 421034 and our plug code 409824. See page 63.

Généralement, cet étagères utilisent notre vis code 421034 et notre cheville code 409824. Voir page 63.



Tornillos y tacos no incluidos en el precio.  
Bolts and plugs not included in the price.  
Les visés et les chevilles ne sont pas inclus dans le prix.

L	A	H	Nº Ganchos Hooks Crochets	Kg	Barcode	€
1.200	400	310	8	6,80	011920	<b>179,00</b>

## Estante mural de fibra abatible

Polyethylene hinged wall shelf

Console murale battante en polyéthylène



Estos estantes se suelen atornillar a la pared con nuestro tornillo cód. 421034 y con el taco cód. 409824. Ver página 63.

These shelves generally use our bolt code 421034 and our plug code 409824. See page 63.



Généralement, cet étagères utilisent notre vis code 421034 et notre cheville code 409824. Voir page 63.

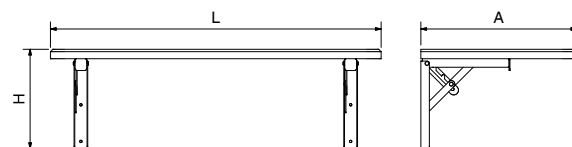

Tornillos y tacos no incluidos en el precio.  
Bolts and plugs not included in the price.  
Les visés et les chevilles ne sont pas inclus dans le prix.

L	A	H	Kg	Barcode	€
700	330	205	2,00	013206	<b>190,00€</b>

## Estante mural inclinado para cestas de lavavajillas

Sloping wall rack shelf

Étagère murale inclinée pour paniers de lavage

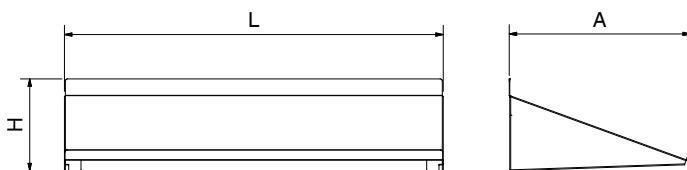
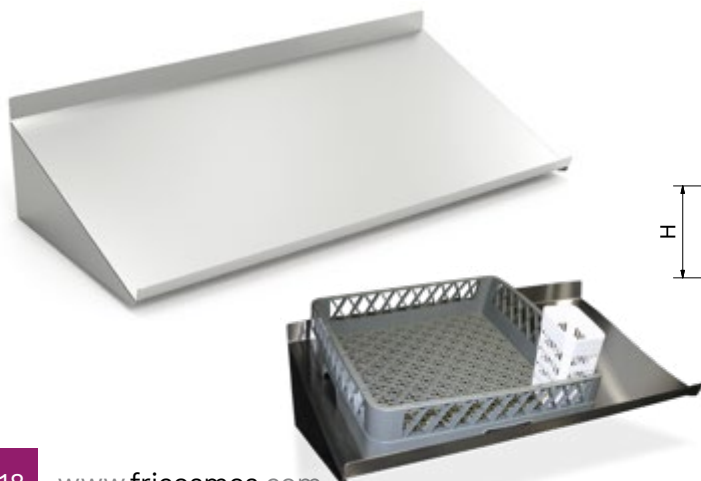

L	A	H	Barcode	Kg	Barcode	€
1.020	488	248	500x500	8,70	011430	<b>185,00</b>
1.550	488	248	500x500	12,50	011432	<b>268,00</b>

## Taburete rodante profesional en acero inoxidable

Sloping wall rack shelf  
Étagère murale inclinée pour paniers de lavage



### Características:

Construido totalmente en acero inoxidable, este taburete profesional móvil de 2 peldaños garantiza a los usuarios una superficie robusta, estable y segura donde alzarse.

Dispone de 3 ruedas retráctiles para un cómodo desplazamiento mientras no está en uso, mientras que cuando el usuario lo utiliza, éste se adhiere al suelo con firmeza para evitar movimientos no deseados.

Gracias a estar fabricado en acero inoxidable, a diferencia de los taburetes del mercado, nuestro taburete es ideal para su utilización en ambientes hostiles, como industria alimentaria en general, industria cárnica, salas frías, salas de despiece, obradores, laboratorios... En resumen, cualquier estancia que precise una higiene rigurosa ya que es fácil de limpiar y desinfectar, incluso con hidrolimpiadora.

### Characteristics:

This professional two steps stainless steel kick stool guarantees to users a robust, stable and safe surface to step onto.

It is supplied with three retractable wheels for easy moving while not in use, whereas it adheres firmly to the ground to prevent unwanted movements when in use.

Made in of stainless steel and thus especially recommended for general food industry (meat industry, cold rooms, laboratories...) or elsewhere with strict hygiene is required, by contrast to most of the step stools on the market.

### Caractéristiques:

Fabriqué en acier inoxydable, ce tabouret professionnel mobile à 2 marches garantit aux utilisateurs une surface robuste, stable et sûre où monter.

Il dispose de 3 roues rétractables pour un déplacement confortable, lorsqu'il n'est pas utilisé, tandis que lorsque on l'utilise, il adhère fermement au sol pour éviter tout mouvement indésirable.

Grâce à sa fabrication en acier inoxydable, contrairement à d'autres modèles sur le marché, notre tabouret est idéal pour une utilisation dans l'industrie alimentaire en général, industrie de la viande, chambres froides, laboratoires... Bref, toute pièce nécessitant une hygiène rigoureuse.

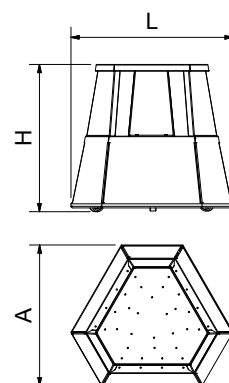

L	A	H	Kg	Barcode	€
479	416	435	5,50	082220	220,00

## Taburete con ruedas

Rolling step-stool  
Tabouret marche - pied roulant



482250 5,80

Rueda de repuesto para taburetes.  
Spare wheel for step-stools.  
Rouelle de rechange pour tabouretes.



### Características:

Este taburete metálico lleva en su base tres ruedas que permiten su fácil traslado de un sitio a otro con un simple empujón del pie. Sin embargo, en el momento en que usted sube sobre él queda totalmente fijado al suelo gracias a su burlete circular que se adhiere como una ventosa.

### Characteristics:

This metallic stool has on its base three castors that allow moving it from one place to another easily, just pushing it with your foot. Furthermore, whenever you are standing on it, it is firmly fixed to the floor, as if it were a suction pad, thanks to its rounded rubber strip.

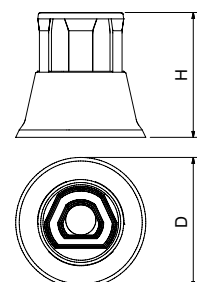

D	H	Kg	Color	Barcode	€
430	430	4,6	Blue	482202	
			Black	482204	69,00
			Grey	482212	

### Caractéristiques:

Ce tabouret métallique a dans sa base trois rouelles qui permettent le déplacer facilement de long en large, avec un seul poussé du pied. En plus, lorsqu'on monte sur lui, il reste totalement fixé au sol, comme une ventouse, grâce à sa bande ronde en caoutchouc.

## Estanterías suspendidas

Hanging wall shelves  
Étagères suspendues



Fabricadas totalmente en acero inoxidable. Esta gama de estanterías suspendidas está diseñada para ayudarle a organizar su espacio de trabajo con seguridad e higiene.

Los estantes son regulables en altura y cuentan con reborde perimetral que dará seguridad al contenido del estante, evitando a su vez posibles derrames y caídas de objetos.

Sus detalles de fabricación proporcionan firmeza y seguridad a toda la estructura.

Totally made in stainless steel. This range of hanging wall shelves is designed to help you to organize your working space in a safe and hygienic way. Their shelves are height adjustable, and are provided with a perimeter flange that will allow a secure storage and will avoid any accidental edge leakage. The particular manufacturing features provide stability and robustness to the whole structure.

Fabriqué entièrement en acier inoxydable, cette gamme de rayonnages suspendus est conçu pour vous aider à organiser votre espace de travail en total sécurité et hygiène.

Les étagères sont réglables en hauteur et ont un rebord qui donnera sécurité au contenu de l'étagère en empêchant les possibles déversements. Ces détails de fabrication fournissent fermeté et sécurité à toute la structure.

015400 4 X 49€

Kit de fijación a techo para estanterías suspendidas  
Ceiling fixing kit for hanging shelves  
Kit de montage pour plafond pour étagères suspendues



081802 25 462

Porta-notas mural  
Wall-mounted tab grabber  
Porte-notes mural

486024 24 389

Contenedor de desperdicios y reciclaje  
Waste and recycling container  
Conteneur à ordures et recyclage

276044 35 320

Adaptador contenedor desperdicios  
Cutlery basket adaptor for service trolleys  
Adaptateur de conteneurs pour chariots de service

454860 2,50 460

Cestillo de plástico para cubiertos  
Plastic cutlery basket  
Plateau à couverts en plastique

276042 18 320

Adaptador de cestillos cuberteros  
Container adaptor for service trolleys  
Adaptateur de panier à utensiles de cuisine pour chariots de service

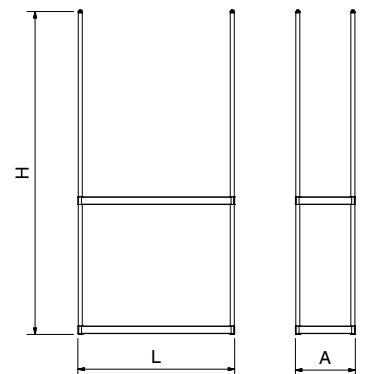

Incluido / Included / Inclus  
Opcional / Optional / Optionnel

⚠ Posibilidad de añadir estantes adicionales. Preparado para atornillar mediante taco expansor.  
Possibility of adding additional shelves. Ready for fixing with expansion shell anchors. Des étagères supplémentaires peuvent être ajoutées.  
Préparé pour le vissage au moyen d'un bouchon d'expansion.

L	A	H	Kg	Barcode	€	Kg	Barcode	€
991	391	2.000	8,0	015402	<b>323,00</b>	3,6	276060	<b>111,00</b>
1.391	391	2.000	10,6	015404	<b>391,00</b>	4,9	276062	<b>136,00</b>
1.891	391	2.000	13,8	015406	<b>469,00</b>	6,5	276064	<b>164,00</b>

## Estanterías de sobremesa

Desktop shelves  
Etagères à poser sur table

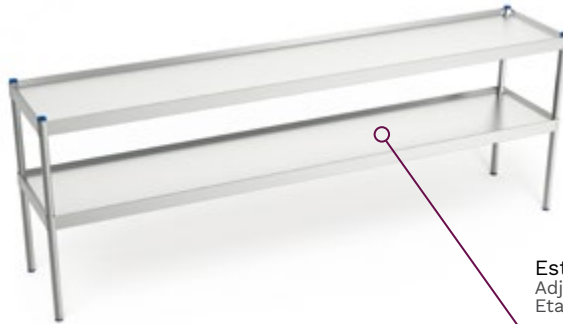

Estantes regulables en altura  
Adjustable shelves  
Etagères réglables en hauteur

Entrepañó opcional  
Optional shelf  
Tablette en option



081802 25 462

Porta-notas mural  
Wall mounted note-holder  
Porte-notes mural



085014 4 X 10€

Kit de fijación  
Fixing kit  
Kit de fixation

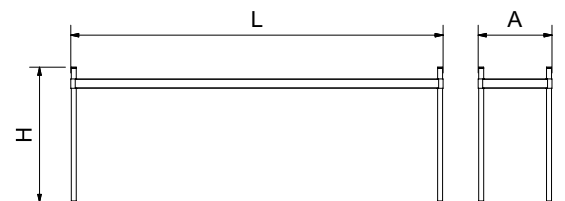

Instalación de sobremesa con o sin fijación.  
Installation on worktop with or without attachment.  
Installation sur dessus avec ou sans fixation.

L	A	H	Kg	€	Kg	€		
991	391	677	3,8	076060	205,00	3,6	276060	111,00
1.391	391	677	5,1	076062	253,00	4,9	276062	136,00
1.891	391	677	6,7	076064	301,00	6,5	276064	164,00

Includido / Included / Inclus  
 Opcional / Optional / Optionnel



## Optimice su espacio con esta nueva estación de trabajo



imagine GN es una nueva herramienta pensada para optimizar el espacio de trabajo. Este innovador sistema emplea un diseño Cantilever que elimina los soportes frontales, incrementando hasta un 40% más el espacio útil de trabajo dentro de la misma zona.

Se instala con facilidad y rapidez. Basado en las dimensiones internacionales GASTRONORM, está fabricado totalmente en acero inoxidable, con un diseño moderno y único.

imagine GN lo podrá utilizar para almacenamiento tanto en lugares secos como en ambientes con humedad, cocinas industriales, salas de preparación y elaboración de alimentos, laboratorios, clínicas, talleres, estaciones de servicio, etc.



Puede regular la altura (cada 140 mm.) y la inclinación de los estantes sin usar herramientas.  
Shelves height (every 140 mm.) and lean can be adjusted without using any tool.  
Vous pouvez régler l'hauteur (tous 140 mm.) et l'inclinaison des étagères sans utiliser des outils.

Con las soluciones modulares imagine GN puede configurar fácil y rápidamente su espacio de trabajo atendiendo a las necesidades de cambio.

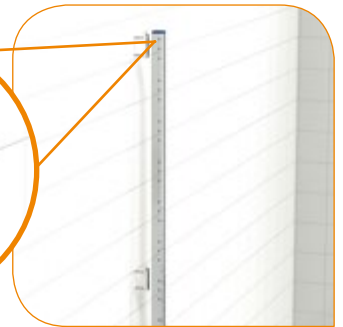

Detalle de fijación a pared.  
Wall fixing detail.  
Détails de fixation murale.



Video



imagine GN Optimize your space with this innovative work station.

imagine GN is a new tool, thought to optimize your work room. This innovative system employs a Cantilever design that eliminates the front supports, increasing up to a 40% the useful surface within the work area.

You can mount it easily and quickly. Based in the international dimensions GASTRONORM, it is made totally in stainless steel, with a modern and unique design.

imagine GN can be used to stock in dry areas as well as in places with wet atmosphere, industrial kitchens, food preparation rooms, laboratories, clinics, garages, petrol stations, etc.

With the imagine GN modular solutions you can easily and quickly design your working area meeting at the same time your needs of change.

Now with imagine GN you will be able to re-design your work area whenever it is necessary.

## LAS NECESIDADES CAMBIAN

Needs change  
Les besoins changent



## Ahora con imagine GN podrá rediseñar su espacio de trabajo cuando sea necesario.

imagine GN Optimisez votre espace avec cette nouvelle station de travail.

imagine GN, c'est un nouveau outil conçu pour optimiser l'espace de travail. Cette innovateur système emploie, un dessin Cantilever qu'évite des supports frontaux, et c'est ainsi qu'on augmente la surface utile dans la zone de travail.

On l'installe facilement et rapidement. Dessinée sur les dimensions internationales Gastronorm, elle est fabriquée totalement en acier inoxydable avec une finition moderne et unique.

imagine GN, vous pouvez l'utiliser pour le stockage dans endroits secs comme dans endroits avec atmosphère humide, cuisines industrielles, salles de préparation des aliments, laboratoires, cliniques, ateliers, stations-service, etc.



Avec les solutions modulaires imagine GN vous pouvez configurer facile et rapidement votre espace de travail en tenant en compte au même temps votre besoins d'échange.

Maintenant avec imagine GN vous pourrez re-dessiner votre espace quand il soit nécessaire.



**Reglajes y resistencia imagine**  
 Adjustment and load strength imagine  
 Réglage et résistance imagine



**Capacidad de estantes:**

Sistema mural 10 niveles por módulo.  
 Sistema central 10 niveles dobles por módulo.

Shelving unit capacity:

Wall-side system – 10 levels per unit.  
 Centre system – 10 double levels per unit.

Capacité des étagères:

Système mural – 10 niveaux par module.  
 Système central – 10 niveaux doubles par module.

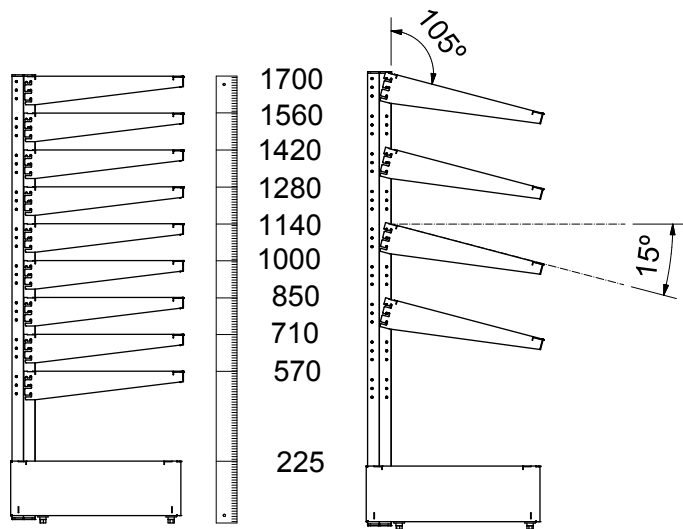

**Kg** = 125 Kg.

Las cargas se consideran uniformemente repartidas en la superficie del estante.

It is assumed that loads are evenly distributed on the shelf surface.

On considère que les charges sont réparties uniformément sur la surface de l'étagère.

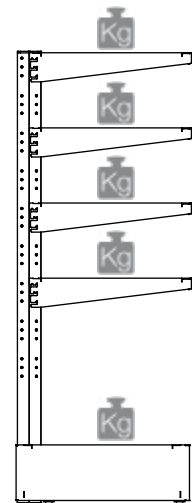

## Estantería gastronorm imagine

Gastronorm Imagine shelving unit  
Étagère gastronorm imagine

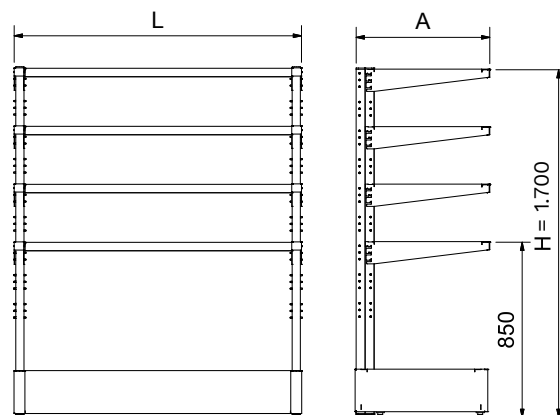

1/1 A = 451 mm  
Número de estantes  
Number of shelves  
Numéro d'étagères

mm	3		4		5	
L	Barcode	€	Barcode	€	Barcode	€
764	016002	892,00	016102	1.028,00	016202	1.164,00
1.174	016004	984,00	016104	1.148,00	016204	1.312,00
1.414	016006	1.114,00	016106	1.316,00	016206	1.518,00
1.475	016008	1.481,00	016108	1.725,00	016208	1.969,00
1.885	016010	1.573,00	016110	1.845,00	016210	2.117,00
2.125	016012	1.703,00	016112	2.013,00	016212	2.323,00
2.186	016014	2.070,00	016114	2.422,00	016214	2.774,00
2.295	016016	1.665,00	016116	1.965,00	016216	2.265,00
2.535	016018	1.795,00	016118	2.133,00	016218	2.471,00
2.596	016020	2.162,00	016120	2.542,00	016220	2.922,00
2.775	016022	1.925,00	016122	2.301,00	016222	2.677,00
2.836	016024	2.292,00	016124	2.710,00	016224	3.128,00
3.006	016026	2.254,00	016126	2.662,00	016226	3.070,00
3.246	016028	2.384,00	016128	2.830,00	016228	3.276,00
3.307	016030	2.751,00	016130	3.239,00	016230	3.727,00
3.416	016032	2.346,00	016132	2.782,00	016232	3.218,00
3.486	016034	2.514,00	016134	2.998,00	016234	3.482,00
3.608	016036	3.248,00	016136	3.816,00	016236	4.384,00
3.717	016038	2.843,00	016138	3.359,00	016238	3.875,00
3.896	016040	2.606,00	016140	3.118,00	016240	3.630,00
4.018	016042	3.340,00	016142	3.936,00	016242	4.532,00

2/1 A = 656 mm  
Número de estantes  
Number of shelves  
Numéro d'étagères

mm	3		4		5	
L	Barcode	€	Barcode	€	Barcode	€
764	016302	996,00	016402	1.154,00	016502	1.312,00
1.174	016304	1.118,00	016404	1.314,00	016504	1.510,00
1.414	016306	1.248,00	016406	1.482,00	016506	1.716,00
1.475	016308	1.652,00	016408	1.934,00	016508	2.216,00
1.885	016310	1.774,00	016410	2.094,00	016510	2.414,00
2.125	016312	1.904,00	016412	2.262,00	016512	2.620,00
2.186	016314	2.308,00	016414	2.714,00	016514	3.120,00
2.295	016316	1.896,00	016416	2.254,00	016516	2.612,00
2.535	016318	2.026,00	016418	2.422,00	016518	2.818,00
2.596	016320	2.430,00	016420	2.874,00	016520	3.318,00
2.775	016322	2.156,00	016422	2.590,00	016522	3.024,00
2.836	016324	2.560,00	016424	3.042,00	016524	3.524,00
3.006	016326	2.552,00	016426	3.034,00	016526	3.516,00
3.246	016328	2.682,00	016428	3.202,00	016528	3.722,00
3.307	016330	3.086,00	016430	3.654,00	016530	4.222,00
3.416	016332	2.674,00	016432	3.194,00	016532	3.714,00
3.486	016334	2.812,00	016434	3.370,00	016534	3.928,00
3.608	016336	3.620,00	016436	4.274,00	016536	4.928,00
3.717	016338	3.208,00	016438	3.814,00	016538	4.420,00
3.896	016340	2.934,00	016440	3.530,00	016540	4.126,00
4.018	016342	3.742,00	016442	4.434,00	016542	5.126,00

## Estantería gastronorm imagine central

Gastronorm Imagine center shelving unit  
Étagère gastronorm imagine centrale

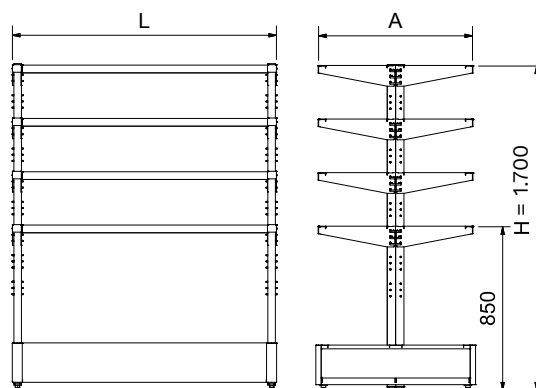

1/1 A = 451 mm  
Número de estantes  
Number of shelves  
Numéro d'étagères

2/1 A = 656 mm  
Número de estantes  
Number of shelves  
Numéro d'étagères

mm	1/1 A = 451 mm			2/1 A = 656 mm		
	3	4	5	3	4	5
L						
764	016602 <b>1.602,00</b>	016702 <b>1.914,00</b>	016802 <b>2.226,00</b>	016902 <b>1.930,00</b>	017002 <b>2.290,00</b>	017102 <b>2.650,00</b>
1.174	016604 <b>1.798,00</b>	016704 <b>2.166,00</b>	016804 <b>2.534,00</b>	016904 <b>2.210,00</b>	017004 <b>2.654,00</b>	017104 <b>3.098,00</b>
1.414	016606 <b>2.130,00</b>	016706 <b>2.598,00</b>	016806 <b>3.066,00</b>	016906 <b>2.518,00</b>	017006 <b>3.054,00</b>	017106 <b>3.590,00</b>
1.475	016608 <b>2.733,00</b>	016708 <b>3.293,00</b>	016808 <b>3.853,00</b>	016908 <b>3.255,00</b>	017008 <b>3.897,00</b>	017108 <b>4.539,00</b>
1.885	016610 <b>2.929,00</b>	016710 <b>3.545,00</b>	016810 <b>4.161,00</b>	016910 <b>3.535,00</b>	017010 <b>4.261,00</b>	017110 <b>4.987,00</b>
2.125	016612 <b>3.261,00</b>	016712 <b>3.977,00</b>	016812 <b>4.693,00</b>	016912 <b>3.843,00</b>	017012 <b>4.661,00</b>	017112 <b>5.479,00</b>
2.186	016614 <b>3.864,00</b>	016714 <b>4.672,00</b>	016814 <b>5.480,00</b>	016914 <b>4.580,00</b>	017014 <b>5.504,00</b>	017114 <b>6.428,00</b>
2.295	016616 <b>3.125,00</b>	016716 <b>3.797,00</b>	016816 <b>4.469,00</b>	016916 <b>3.815,00</b>	017016 <b>4.625,00</b>	017116 <b>5.435,00</b>
2.535	016618 <b>3.457,00</b>	016718 <b>4.229,00</b>	016818 <b>5.001,00</b>	016918 <b>4.123,00</b>	017018 <b>5.025,00</b>	017118 <b>5.927,00</b>
2.596	016620 <b>4.060,00</b>	016720 <b>4.924,00</b>	016820 <b>5.788,00</b>	016920 <b>4.860,00</b>	017020 <b>5.868,00</b>	017120 <b>6.876,00</b>
2.775	016622 <b>3.789,00</b>	016722 <b>4.661,00</b>	016822 <b>5.533,00</b>	016922 <b>4.431,00</b>	017022 <b>5.425,00</b>	017122 <b>6.419,00</b>
2.836	016624 <b>4.392,00</b>	016724 <b>5.336,00</b>	016824 <b>6.320,00</b>	016924 <b>5.728,00</b>	017024 <b>6.996,00</b>	017124 <b>8.264,00</b>
3.006	016626 <b>4.256,00</b>	016726 <b>5.176,00</b>	016826 <b>6.096,00</b>	016926 <b>5.140,00</b>	017026 <b>6.232,00</b>	017126 <b>7.324,00</b>
3.246	016628 <b>4.588,00</b>	016728 <b>5.608,00</b>	016828 <b>6.628,00</b>	016928 <b>5.448,00</b>	017028 <b>6.632,00</b>	017128 <b>7.816,00</b>
3.307	016630 <b>5.191,00</b>	016730 <b>6.303,00</b>	016830 <b>7.415,00</b>	016930 <b>6.285,00</b>	017030 <b>7.475,00</b>	017130 <b>8.765,00</b>
3.416	016632 <b>4.452,00</b>	016732 <b>5.428,00</b>	016832 <b>6.404,00</b>	016932 <b>5.920,00</b>	017032 <b>6.596,00</b>	017132 <b>7.772,00</b>
3.486	016634 <b>4.920,00</b>	016734 <b>6.040,00</b>	016834 <b>7.160,00</b>	016934 <b>5.756,00</b>	017034 <b>7.032,00</b>	017134 <b>8.308,00</b>
3.608	016636 <b>6.126,00</b>	016736 <b>7.430,00</b>	016836 <b>8.734,00</b>	016936 <b>7.230,00</b>	017036 <b>8.718,00</b>	017136 <b>10.206,00</b>
3.717	016638 <b>5.387,00</b>	016738 <b>6.555,00</b>	016838 <b>7.723,00</b>	016938 <b>6.465,00</b>	017038 <b>7.839,00</b>	017138 <b>9.213,00</b>
3.896	016640 <b>5.116,00</b>	016740 <b>6.292,00</b>	016840 <b>7.468,00</b>	016940 <b>6.036,00</b>	017040 <b>7.396,00</b>	017140 <b>8.756,00</b>
4.018	016642 <b>6.322,00</b>	016742 <b>7.682,00</b>	016842 <b>9.042,00</b>	016942 <b>7.510,00</b>	017042 <b>9.082,00</b>	017142 <b>10.654,00</b>

## Estanterías gastronorm imagine a pared

Gastronorm Imagine wall-side shelving unit  
Étagère gastronorm imagine pour mur

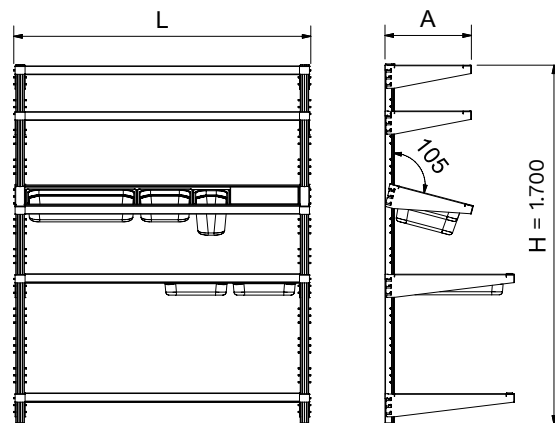

1/1 A = 451 mm  
Número de estantes  
Number of shelves  
Numéro d'étagères

2/1 A = 656 mm  
Número de estantes  
Number of shelves  
Numéro d'étagères

mm	1/1 A = 451 mm			2/1 A = 656 mm		
	3	4	5	3	4	5
L						
764	017202 <b>606,00</b>	017302 <b>742,00</b>	017402 <b>878,00</b>	017502 <b>672,00</b>	017602 <b>830,00</b>	017702 <b>988,00</b>
1.174	017204 <b>690,00</b>	017304 <b>854,00</b>	017404 <b>1.018,00</b>	017504 <b>786,00</b>	017604 <b>982,00</b>	017704 <b>1.178,00</b>
1.414	017206 <b>804,00</b>	017306 <b>1.006,00</b>	017406 <b>1.208,00</b>	017506 <b>900,00</b>	017606 <b>1.134,00</b>	017706 <b>1.368,00</b>
1.475	017208 <b>1.029,00</b>	017308 <b>1.273,00</b>	017408 <b>1.517,00</b>	017508 <b>1.143,00</b>	017608 <b>1.425,00</b>	017708 <b>1.707,00</b>
1.885	017210 <b>1.113,00</b>	017310 <b>1.385,00</b>	017410 <b>1.657,00</b>	017510 <b>1.257,00</b>	017610 <b>1.577,00</b>	017710 <b>1.897,00</b>
2.125	017212 <b>1.227,00</b>	017312 <b>1.537,00</b>	017412 <b>1.847,00</b>	017512 <b>1.371,00</b>	017612 <b>1.729,00</b>	017712 <b>2.078,00</b>
2.186	017214 <b>1.452,00</b>	017314 <b>1.804,00</b>	017414 <b>2.156,00</b>	017514 <b>1.614,00</b>	017614 <b>2.020,00</b>	017714 <b>2.426,00</b>
2.295	017216 <b>1.197,00</b>	017316 <b>1.497,00</b>	017416 <b>1.797,00</b>	017516 <b>1.371,00</b>	017616 <b>1.729,00</b>	017716 <b>2.087,00</b>
2.535	017218 <b>1.311,00</b>	017318 <b>1.649,00</b>	017418 <b>1.987,00</b>	017518 <b>1.485,00</b>	017618 <b>1.881,00</b>	017718 <b>2.277,00</b>
2.596	017220 <b>1.536,00</b>	017320 <b>1.916,00</b>	017420 <b>2.296,00</b>	017520 <b>1.728,00</b>	017620 <b>2.172,00</b>	017720 <b>2.616,00</b>
2.775	017222 <b>1.425,00</b>	017322 <b>1.801,00</b>	017422 <b>2.177,00</b>	017522 <b>1.599,00</b>	017622 <b>2.033,00</b>	017722 <b>2.467,00</b>
2.836	017224 <b>1.650,00</b>	017324 <b>2.068,00</b>	017424 <b>2.486,00</b>	017524 <b>1.842,00</b>	017624 <b>2.324,00</b>	017724 <b>2.806,00</b>
3.006	017226 <b>1.620,00</b>	017326 <b>2.028,00</b>	017426 <b>2.436,00</b>	017526 <b>1.842,00</b>	017626 <b>2.324,00</b>	017726 <b>2.806,00</b>
3.246	017228 <b>1.734,00</b>	017328 <b>2.180,00</b>	017428 <b>2.626,00</b>	017528 <b>1.956,00</b>	017628 <b>2.476,00</b>	017728 <b>2.996,00</b>
3.307	017230 <b>2.935,00</b>	017330 <b>2.447,00</b>	017430 <b>2.935,00</b>	017530 <b>2.199,00</b>	017630 <b>2.767,00</b>	017730 <b>3.355,00</b>
3.416	017232 <b>2.576,00</b>	017332 <b>2.140,00</b>	017432 <b>2.576,00</b>	017532 <b>1.656,00</b>	017632 <b>2.476,00</b>	017732 <b>2.996,00</b>
3.486	017234 <b>1.848,00</b>	017334 <b>2.332,00</b>	017434 <b>2.816,00</b>	017534 <b>2.070,00</b>	017634 <b>2.628,00</b>	017734 <b>3.186,00</b>
3.608	017236 <b>2.298,00</b>	017336 <b>2.866,00</b>	017436 <b>3.434,00</b>	017536 <b>2.556,00</b>	017636 <b>3.210,00</b>	017736 <b>3.864,00</b>
3.717	017238 <b>2.043,00</b>	017338 <b>2.559,00</b>	017438 <b>3.075,00</b>	017538 <b>2.313,00</b>	017638 <b>2.919,00</b>	017738 <b>3.525,00</b>
3.896	017240 <b>2.956,00</b>	017340 <b>2.444,00</b>	017440 <b>2.956,00</b>	017540 <b>2.184,00</b>	017640 <b>2.780,00</b>	017740 <b>3.376,00</b>
4.018	017242 <b>2.382,00</b>	017342 <b>2.978,00</b>	017442 <b>3.574,00</b>	017542 <b>2.670,00</b>	017642 <b>3.362,00</b>	017742 <b>4.054,00</b>

**Pies murales imagine**  
Wall-side legs imagine  
Pieds muraux imagine

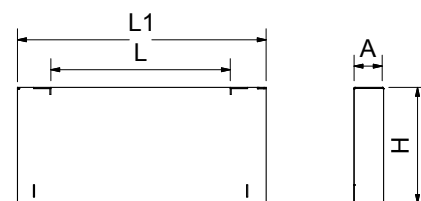

L	A	H	L1	Kg	Barcode	€
325	53	210	450	3,50	013806	<b>89,00€</b>
530	53	210	655	5,25	013808	<b>114,00€</b>

**Pies centrales imagine**  
Centre legs imagine  
Pieds centraux imagine

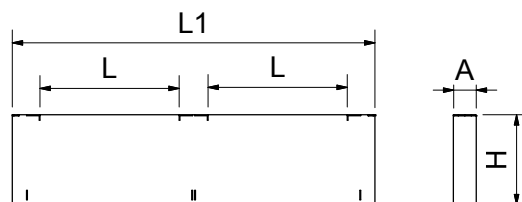

L	A	H	L1	Kg	Barcode	€
325	53	210	850	6,2	013802	<b>135,00€</b>
530	53	210	1.260	9,2	013804	<b>225,00€</b>

**Largueros inferiores imagine**  
Lower crossbars imagine  
Montants inférieurs imagine

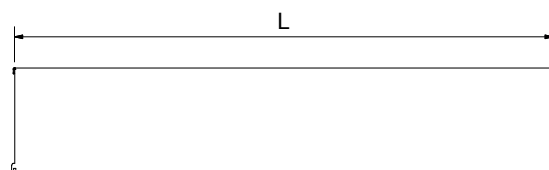

L	Kg	Barcode	€
665	2,7	014252	<b>46,00</b>
1.075	4,0	014254	<b>59,00</b>
1.315	5,4	014256	<b>74,00</b>

**Soporte imagine**  
Support imagine  
Support imagine

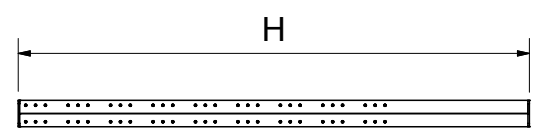
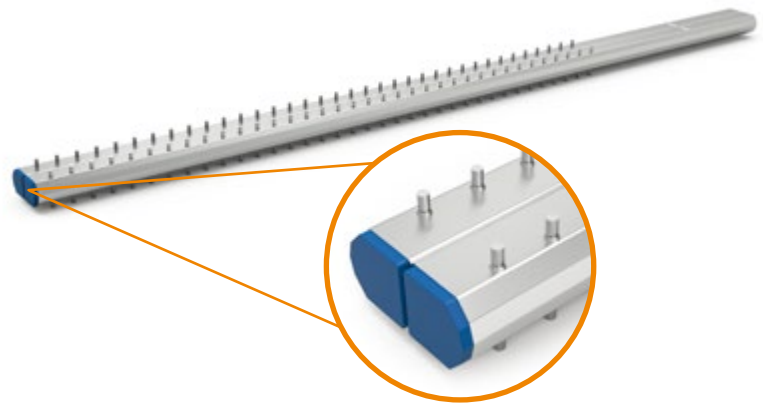

H	Kg	Barcode	€
1.700	6	013602	<b>158,00</b>

**Soporte imagine a pared**  
Support for Imagine hanging wall shelf  
Support pour Imagine murale suspendue

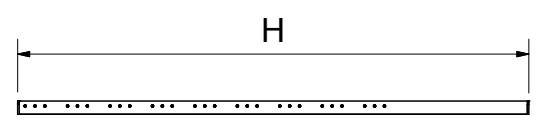
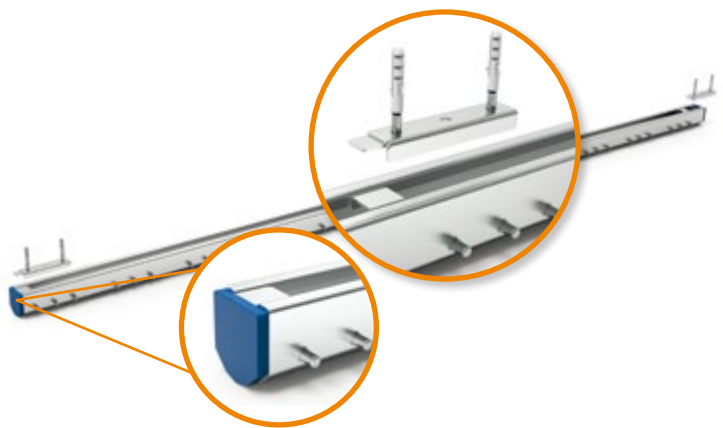

H	Kg	Barcode	€
860	1,5	013606	<b>64,00</b>
1.700	3,0	013604	<b>99,00</b>

**Cartelas imagine**  
Brackets imagine  
Consoles imagine

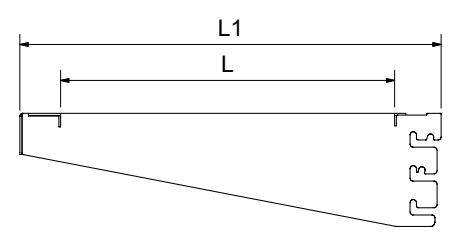

L	L1	Kg	Barcode	€
325	410	1,8	014002	<b>28,00</b>
530	615	2,5	014004	<b>34,00</b>

**Largueros superiores imagine**  
Upper crossbars imagine  
Montants supérieurs imagine

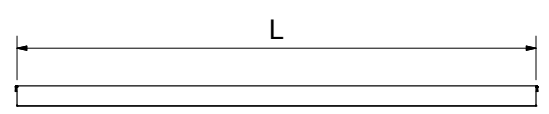

L	Kg	Barcode	€
665	1,3	014202	<b>23,00</b>
1.075	1,9	282806	<b>32,00</b>
1.315	2,4	014204	<b>39,00</b>

### Estantes inox imagine

Stainless steel shelves imagine  
Étagères en acier inoxydable imagine

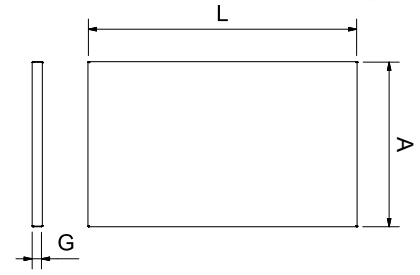

L	A	G	Kg	Barcode	€
325	325	20	1,0	013402	<b>17,00€</b>
530	325	20	1,5	013404	<b>22,00€</b>
530	530	20	2,0	013406	<b>32,00€</b>

### Estantes fibra imagine

Polyethylene shelves imagine  
Étagères en polyéthylène imagine

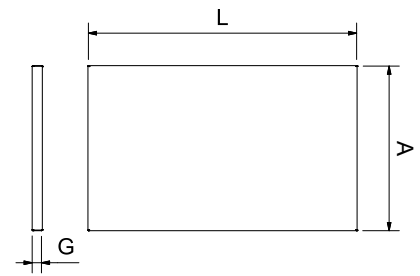

Color	L	A	G	Kg	Barcode	€
Red	325	325	20	2,12	434602	<b>21,00</b>
	530	325	20	3,45	434604	<b>33,00</b>
	530	530	20	5,62	434606	<b>55,00</b>
White	325	325	20	2,12	434610	<b>21,00</b>
	530	325	20	3,45	434612	<b>33,00</b>
	530	530	20	5,62	434614	<b>55,00</b>
Yellow	325	325	20	2,12	434620	<b>21,00</b>
	530	325	20	3,45	434622	<b>33,00</b>
	530	530	20	5,62	434624	<b>55,00</b>
Blue	325	325	20	2,12	434630	<b>21,00</b>
	530	325	20	3,45	434632	<b>33,00</b>
	530	530	20	5,62	434634	<b>55,00</b>
Green	325	325	20	2,12	434640	<b>21,00</b>
	530	325	20	3,45	434642	<b>33,00</b>
	530	530	20	5,62	434644	<b>55,00</b>

### Hacer agujero de desbarasado a estantes imagine

Imagine shelf perforation for waste chutes  
Perforer étagère imagine pour évacuation de déchets

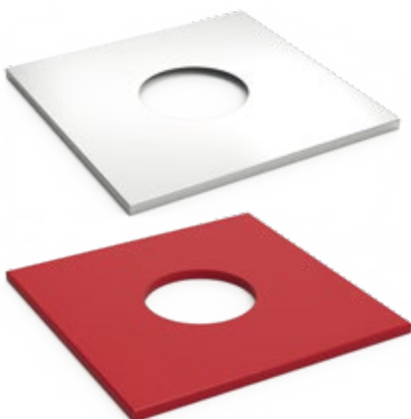

Color	Material	Barcode	€
White	Acero inoxidable Stainless steel Acier inoxydable	015002	<b>59,00</b>
Red	Fibra Fibre Fibre	434802	<b>33,00</b>

## Kit para colgar utensilios imagine

Tool-holder kit imagine  
Kit pour accroche des outils imagine

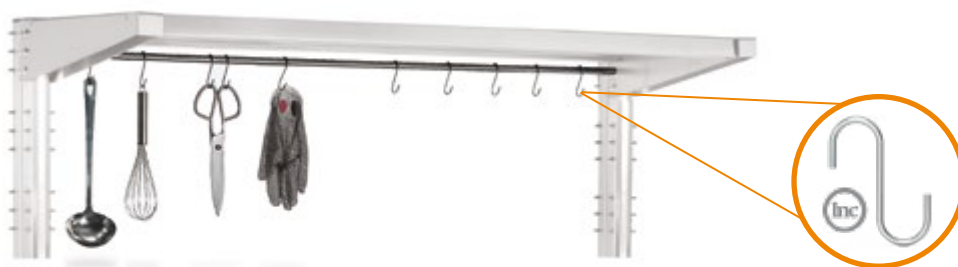

46

H	E	D	Barcode	L	✓	Kg	Barcode	€
60	16	3	9200606022502	650	10	0,30	014602	33,00
1.060	10	0,50	014604	1.060	10	0,50	014604	35,00
1.300	20	0,65	014606	1.300	20	0,65	014606	36,00

## Boxes modulares

Modular boxes  
Boxes modulaires



312

Con este sistema de boxes modulares ya puede configurar a su medida las mesas, fregaderos, estanterías, tajos, etc.

Basados en las dimensiones internacionales GASTRONORM están fabricados totalmente en acero inoxidable. Su diseño moderno y funcional permite adaptar guías, cajones, cubetas, puertas etc.

With this system of modular boxes now you can adapt to your needs tables, sink units, shelving units, chopping blocks, etc.

Based in the international dimensions GASTRONORM, it is made totally from stainless steel. Its innovative and functional design allows the fitting of elements such as guides, drawers, pans, doors, etc.

Avec le système de boxes modulaires maintenant vous pouvez adapter à vos besoins tables, éviers, étagères, billots, etc.

Ce système, basé dans les mesures internationales GASTRONORM, est fabriqué totalement en acier inoxydable. Sa conception moderne et fonctionnelle permet d'adapter guides, tiroirs, bacs, portes, etc.

## Cajón acoplado a estante 2/1 imagine

Drawer assembled to shelf 2/1 imagine  
Tiroir assemblé à étagère 2/1 imagine



085450 **273,00**



085452 **306,00**



## Porta-precios imagine

Price-holder imagine  
Porte prix imagine



Se acoplan con facilidad a los largueros superiores.

Easy to assemble to the upper crossbars.

Facilité d'assemblage aux montants supérieurs.

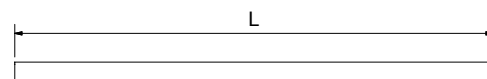

L	Gr	Barcode	€
650	65	415250	<b>5,25</b>
1.060	105	415252	<b>8,40</b>
1.300	130	415254	<b>9,45</b>

## Útil de montaje imagine

Assembly tool imagine  
Outil de montage imagine



Facilita considerablemente el montaje.

It makes the assembly greatly easier.

Il facilite l'assemblage.

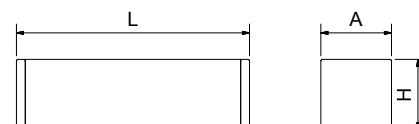

L	A	H	Gr	Barcode	€
125	40	40	180	014402	<b>5,00</b>

## Peto transparente imagine

Transparent front panel for imagine  
Panneau frontal transparent pour imagine

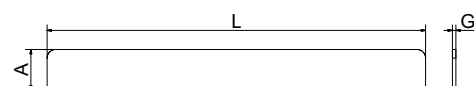

L	A	G	Gr	Barcode	€
655	70	6	175	014802	<b>43,00</b>
1.065	70	6	250	014804	<b>55,00</b>
1.305	70	6	375	014806	<b>65,00</b>

## Mesa central de emplatado imagine

Preparing and serving centre table imagine  
Table centrale pour préparation et service imagine



435

Cubetas Gastronorm.  
Gastronorm trays.  
Bacs gastronorm.



434602 21,00  
434802 33,00 29

Estante en fibra de polietileno con agujero.  
Perforated polyethylene shelves.  
Étagères perforées en polyéthylène.



486004 187,00 386

Contenedor inoxidable con tapa.  
Stainless steel dustbin.  
Poubelle inox.



87

Cuchillería profesional.  
Professional cutlery.  
Coutellerie professionnelle.

Includido / Included / Inclus  
 Opcional / Optional / Optionnel

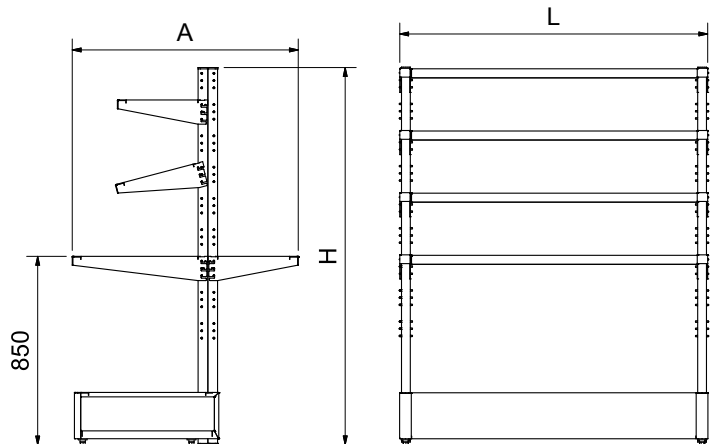

L	A	H	Kg	Barcode	€
764	1.050	1.700	61	910020402	<b>1.246,00</b>
1.174	1.050	1.700	71	910020404	<b>1.414,00</b>
1.414	1.050	1.700	82	910020406	<b>1.620,00</b>

## Mesa mural con estantes sobremesa serie imagine

Wall-side table with superior shelves serie imagine  
Table murale avec étagères sur table modèle imagine



014602 33,00 30

Kit para colgar utensilios.  
Tool-holder kit.  
Kit pour suspendre outils.



448616 115,00 354

Guante de malla de acero inoxidable Expert.  
Expert stainless steel mesh glove.  
Gant en maille d'acier inoxydable Expert.



132  
Tijeras pescadero.  
Fish scissors.  
Ciseaux à poisson.



434602 21,00  
434802 33,00 29

Estante en fibra de polietileno con agujero.  
Perforated polyethylene shelves.  
Étagères perforées en polyéthylène.



87  
Cuchillería profesional.  
Professional cutlery.  
Coutellerie professionnelle.



435  
Cubetas Gastronorm.  
Gastronorm trays.  
Bacs gastronorm.



486004 187,00 386

Contenedor inoxidable con tapa.  
Stainless steel dustbin.  
Poubelle inoxydable.



085452 306,00 30

Cajón acoplado.  
Coupled drawer.  
Tiroir accouplé.

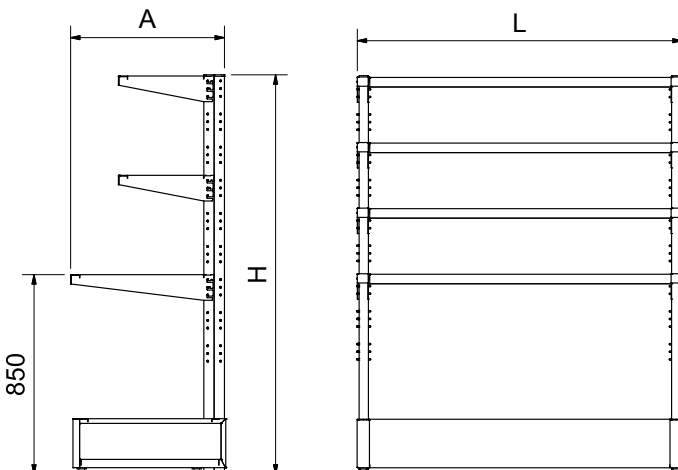

Incluido / Included / Inclus  
 Opcional / Optional / Optionnel

L	A	H	Kg	Barcode	€
764	655	1.700	55	910020502	<b>1.110,00</b>
1.174	655	1.700	64	910020504	<b>1.250,00</b>
1.414	655	1.700	73	910020506	<b>1.418,00</b>

## Mesa central con estantes de sobremesa sistema imagine

Centre table with tabletop shelves imagine system

Table centrale avec étagères à poser sur table système imagine



081802 25,00 462

Porta notas mural acoplado.  
Wall-mounted tab grabber.  
Porte notes mural.



434442 140,00 85

Mortero de fibra.  
Mortar.  
Mortier.



080202 60,00 399

Dispensador de bobinas para envolver de 350 mm.  
Dispenser rolls of wrapping material.  
Dévidoir de rouleaux pour protéger les aliments.



434440 52,00 84

Rodillo de fibra.  
Rolling pin.  
Rouleau.



87

Cuchillería profesional.  
Professional cutlery.  
Coutellerie professionnelle.



486004 187,00 386

Contenedor inoxidable con tapa.  
Stainless steel dustbin.  
Poubelle inoxydable.



431608 32,00 75

Fibra estándar azul de 500x300x20 mm.  
Blue standard fibre 500x300x20 mm.  
Fibre standard bleue 500x300x20 mm.



041202 123,00 137

Portacuchillos con doble alojamiento de sobremesa.  
Plated knife holder for mounting.  
Porte-couteaux plaqué pour adosser.

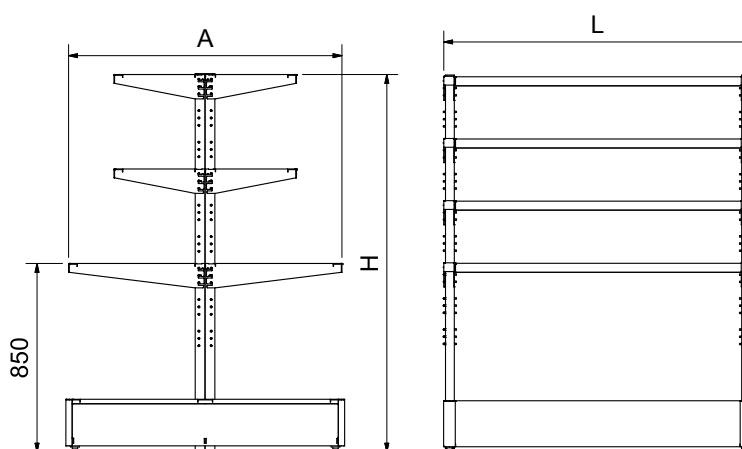

L	A	H	Kg	Barcode	€
764	1.255	1.700	77	910020602	<b>1.898,00</b>
1.174	1.255	1.700	95	910020604	<b>2.178,00</b>
1.414	1.255	1.700	115	910020606	<b>2.514,00</b>

Incluido / Included / Inclus  
 Opcional / Optional / Optionnel

## Estantería con armario para botellas de zumo

Shelf with cupboard for juice bottles

Rayonnage avec armoire pour bouteilles de jus de fruits

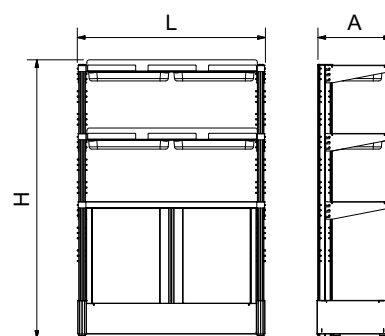

L	A	H	🔧	🔄	📦	📊	€
1.174	451	1.700	3	2	73,00	013060	<b>1.975,00</b>

## Accesorios para estanterías

Accessories for shelves

Accessoires pour étagères



Cajones  
Drawers  
Tiroirs

492



Boxes modulares  
Modular boxes  
Boxes modulaires

312



Ruedas  
Wheels  
Rouelle

496



Taco regulable para soporte de estantería  
Adjustable block for shelving support  
Taquet réglable pour supports de rayonnage

498



Cubetas Gastronorm lisas  
Non-perforated Gastronorm containers  
Bacs Gastronorm lisses



435

## Estantería inox para almacenaje de vino

Stainless steel shelving for wine storage

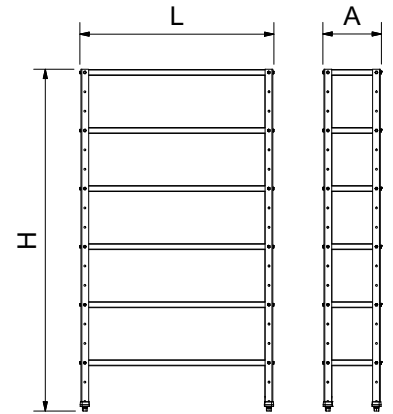
Rayonnage en acier inoxydable pour le stockage du vin



L	A	H				€
800	300	1.750	8	24,78	083020	<b>443,00</b>
1.000	300	1.750	11	27,33	083022	<b>531,00</b>
1.200	300	1.750	13	30,94	083024	<b>612,00</b>
1.400	300	1.750	15	34,55	083026	<b>690,00</b>

## Estante inox para almacenaje de vino

Stainless steel shelf for wine storage

Étagère inox pour stockage du vin

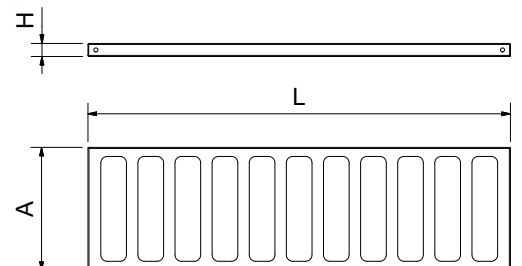

L	A	H				€
800	300	31	8	2,68	283020	<b>59,00</b>
1.000	300	31	11	3,10	283022	<b>76,00</b>
1.200	300	31	13	3,71	283024	<b>93,00</b>
1.400	300	31	15	4,31	283026	<b>109,00</b>

**Botellero de sobremesa para botellas de vino**  
 Countertop rack for wine bottles  
 Porte-bouteilles support sur table pour vin

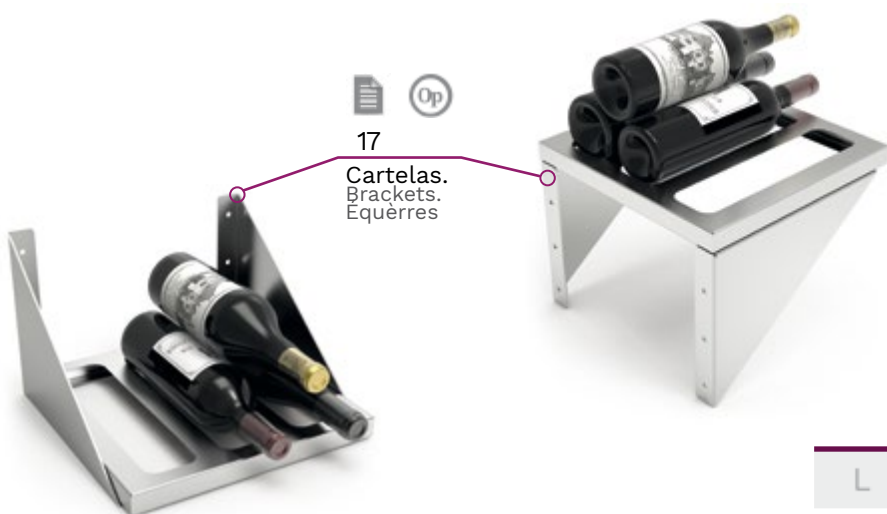

Op

17  
 Cartelas.  
 Brackets.  
 Equérres

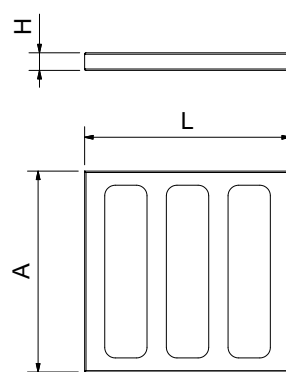

L	A	H	Kg	Barcode	€
292	285	25	0,67	083028	<b>27,00</b>

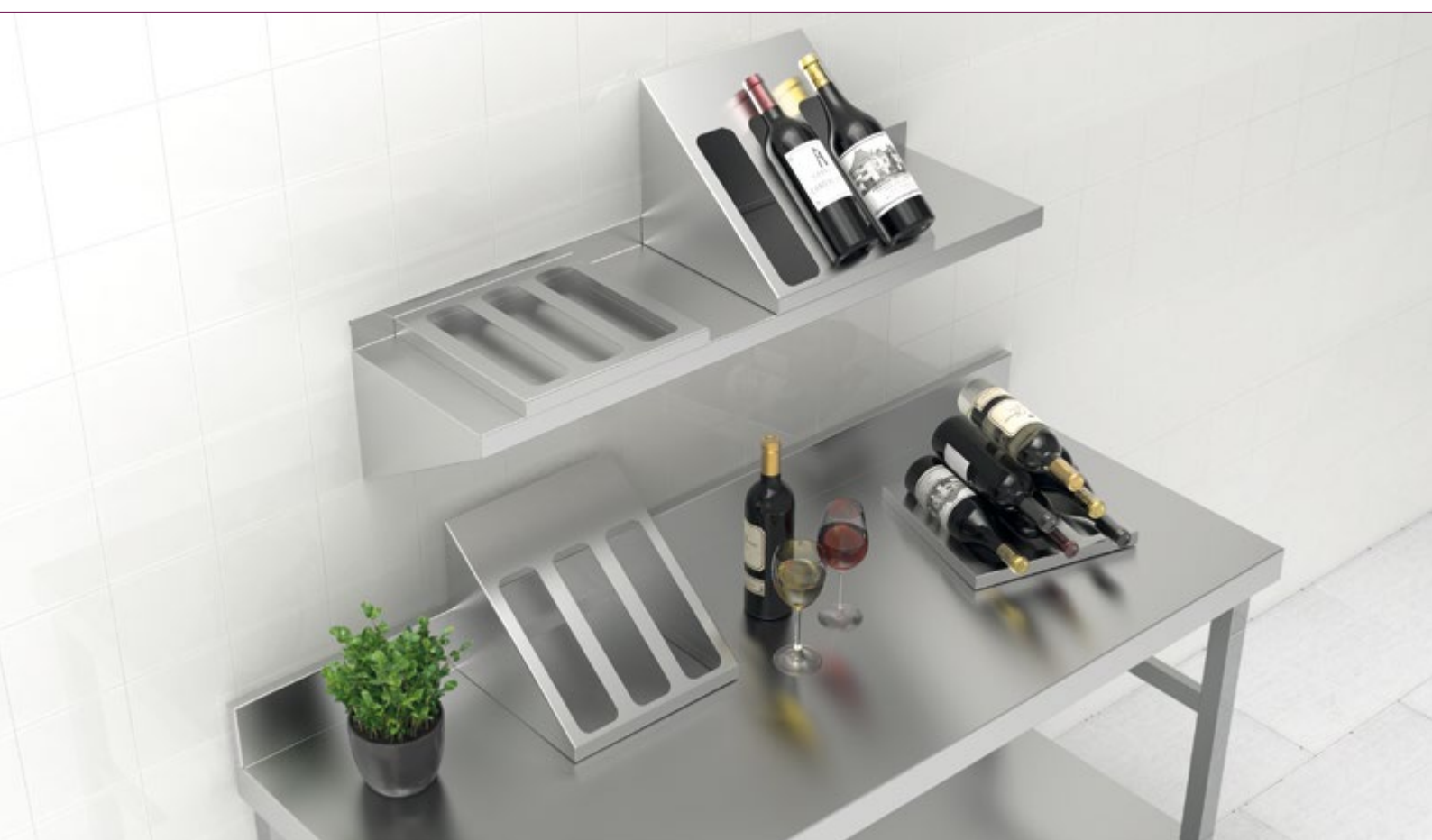

**Botellero expositor inox de sobremesa para botellas de vino**  
 Stainless steel countertop rack for displaying wine  
 Porte-bouteilles présentoir de table en inox pour bouteilles de vin



17

Cartelas.  
 Brackets.  
 Équerres

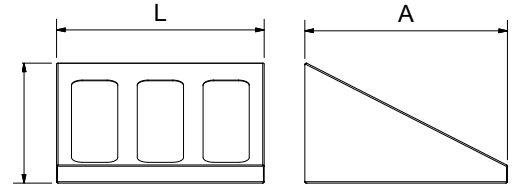

L	A	H		Kg		€
292	285	169	3	1,36	083030	<b>49,00</b>







# HERRAJES

HOOKS AND STAINLESS STEEL FIXTURES  
FERRURES ET CROCHETS



**NOVEDADES**  
NEWS  
NOUVEAUTÉS



52



57



59

## Columnas perforadas para pletina

Perforated columns for flat bar  
Colonnes perforées pour platine



### Características:

La ventaja del sistema de columnas perforadas para pletina es la facilidad de montaje, pues al pasar la pletina a través de la columna nos permite desplazarla lateralmente (en caso de encontrar algún obstáculo como un desagüe que vaya a la pared, etc.). Con el sistema de separadores estándar se consigue adaptar perfectamente todo el conjunto de columnas al perímetro de la cámara, logrando una excelente estabilidad, además de no tener que quitar las curvas sanitarias que todas las cámaras llevan en paredes y suelos.

Como opción se pueden solicitar pletinas de cruce (tal y como figura en la fotografía), teniendo en cuenta que la distancia entre columnas no debe superar los 1.000 mm. También se fabrican, bajo pedido, columnas para apoyo con diferentes alturas de barras.

La pletina para estas columnas tiene que ser de 40x8 mm necesariamente.

### Characteristics:

The main advantage of the perforated column system for plate is the ease of installing, since when passing the plate through the column you can move it laterally in the case of any obstacle (such as any drainpipe on the wall, etc.). Furthermore, and with the standard detach system, you can get a perfect joint of the whole column set within the chamber perimeter, resulting in an excellent stability. Also, there is no need to remove the sanitary curve all chambers have in walls and floor.

In addition, and as an option, you can ask for crossing plates (as can be seen in the drawing), taking into account that distance between columns must not exceed 1.000 mm. They are made as well in several height bars, etc previous order. Plate for these columns must be 40x8 mm compulsory.

### Caractéristiques:

La principale avantage du système de colonnes perforées pour platines c'est la facilité du montage, car quand on passe la platine à travers la colonne, il est possible le déplacement latéral dans le cas de trouver quelque obstacle (comme les décharges des eaux dans le mur, etc.). Autre cela, et avec le système standard des séparateurs, on achève une parfaite adaptation pour l'assemblage dans tout le périmètre du chambre. En plus, on n'a pas besoin de quitter les courbures sanitaires que tous les chambres doivent avoir dans murs et sol.

En autre, et optionnellement, vous pouvez commander platines d'intersection (tel que la photographie) en tenant en compte la distance entre colonnes, qu'elle ne doit pas excéder 1.000 mm. Les colonnes, elles sont fabriquées pour support commande préalable, avec différent hauteur des barres, etc.

Las platinas para ces colonnes doivent être 40x8 mm obligatoirement.



### ¿Necesita ayuda?

Díganos las medidas útiles interiores de la cámara (largo x ancho x alto), ubicación de la puerta y sus medidas (ancho x alto). Le informaremos del precio, plazo de entrega e instrucciones de montaje.

### Need some help?

Tell us the interior dimensions of the useful area in the room (length x width x height) as well as the location of the door and its measurements (width x height). We will provide you the price, delivery time and assembly instructions.

### Vous avez besoin d'aide?

Dites-nous les mesures intérieures utiles de la pièce (longueur x largeur x hauteur), l'emplacement de la porte et ses mesures (largeur x hauteur). Nous vous informerons du prix, du délai de livraison et des instructions de montage.

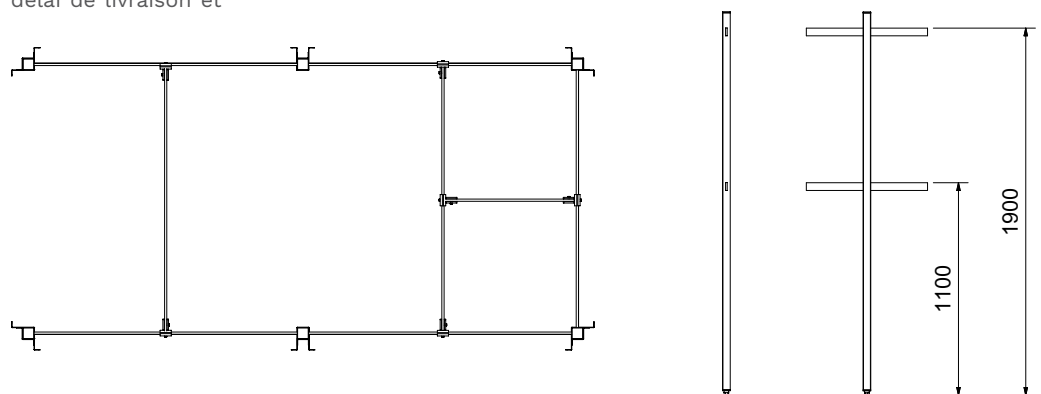

Necesitan 3 separadores por columna para su instalación.

3 separators are required for their installing.  
Il sont nécessaires 3 séparateurs pour son installation.

Tornillos opcionales.  
Optional screws and bolts.  
Vis optionnelles.



Central  
Center  
Central

Esquina  
Corner  
Coin

Terminal  
Terminal  
Terminal

Sección  
Section  
Section



€



€



€

40x40

2,44

020202 57,00

020204 57,00

020206 57,00

## Separadores centrales

Central separators  
Séparateurs central

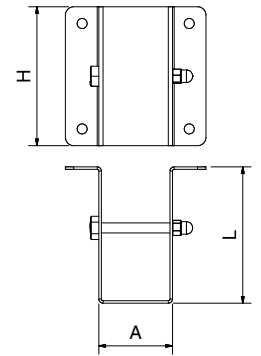

L	A	H	Gr	Barcode	€
80	40	83	300	020402	17,00
140	40	83	600	020406	20,00

## Separadores de esquina

Corner separators  
Séparateurs de coin

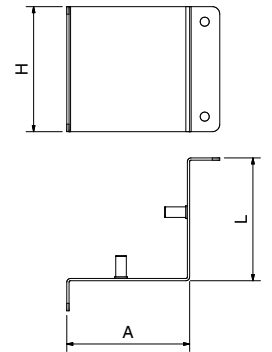
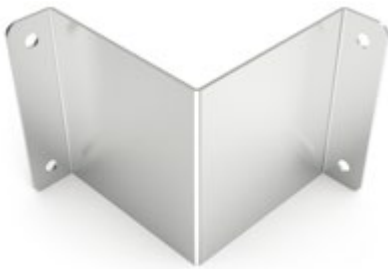

L	A	H	Gr	Barcode	€
80	80	83	300	020404	17,00
140	140	83	600	020408	20,00

## Detalles

Details  
Détails

Detalle de columna terminal.  
Details of terminal column.  
Détail colonne terminal.

Detalle de columna central.  
Details of the central column.  
Détail colonne centrale.

Detalle de columna en esquina.  
Details of the corner column.  
Détail colonne sur coin.

Detalle de pletinas transversales.  
Details of the transversal plates.  
Détail barres transversales.

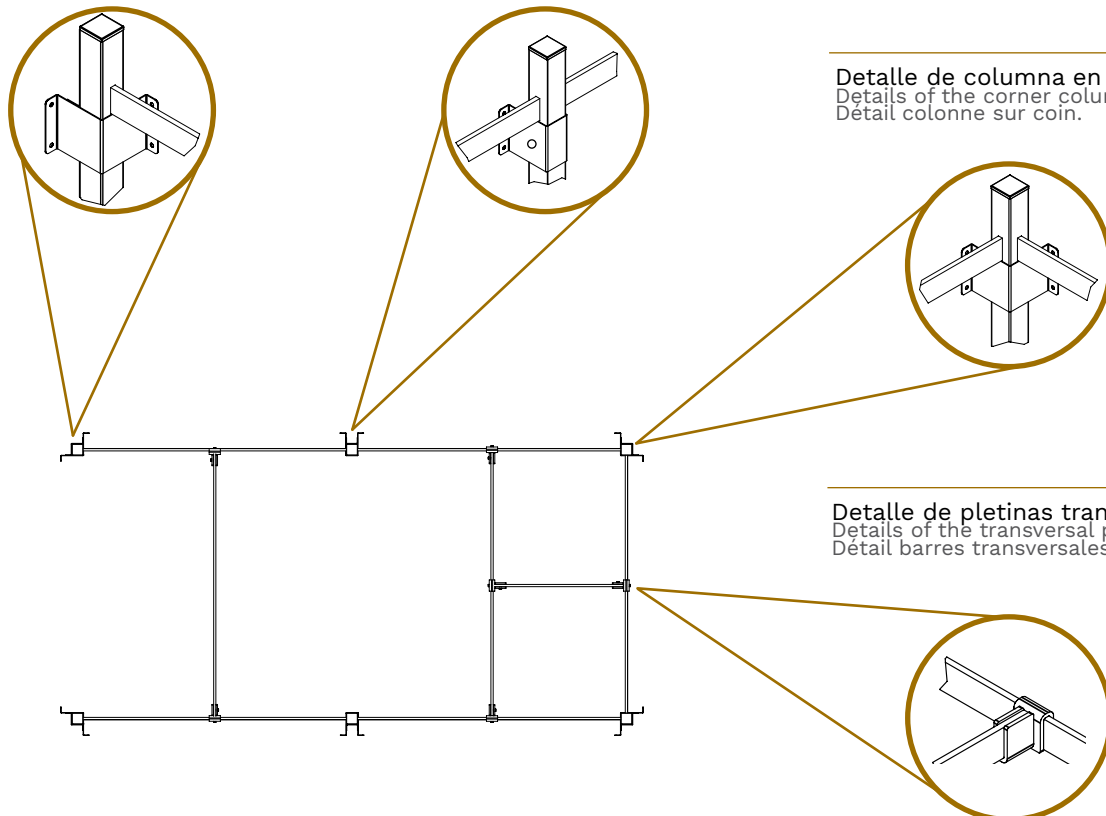

## Columnas para tubo de 38 mm

Columns for 38 mm round tube  
Colonnes pour tubes 38 mm



### ¿Necesita ayuda?

Díganos las medidas útiles interiores de la cámara (largo x ancho x alto), ubicación de la puerta y sus medidas (ancho x alto). Le informaremos del precio, plazo de entrega e instrucciones de montaje.

### Need some help?

Tell us the interior dimensions of the useful area in the room (length x width x height) as well as the location of the door and its measurements (width x height). We will provide you the price, delivery time and assembly instructions.

### Vous avez besoin d'aide?

Dites-nous les mesures intérieures utiles de la pièce (longueur x largeur x hauteur), l'emplacement de la porte et ses mesures (largeur x hauteur). Nous vous informerons du prix, du délai de livraison et des instructions de montage.

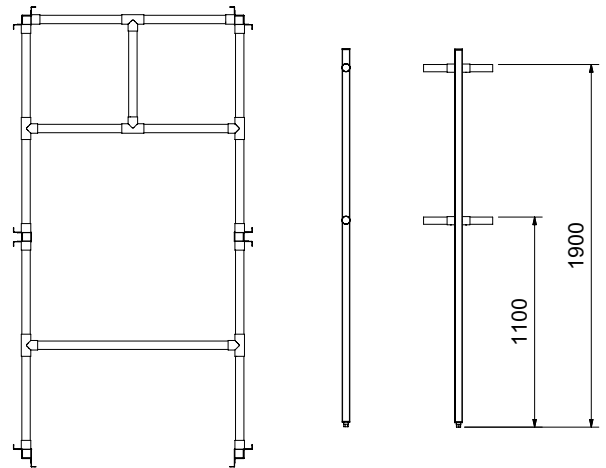

**Necesitan 3 separadores por columna para su instalación.**

3 separators are required for their installing.

Il sont nécessaires 3 séparateurs pour son installation.

**Tornillos opcionales.**

Optional screws and bolts.

Vis optionnelles.

	Central Central Central	Esquina Corner Coin	Terminal Terminal Terminal
Sección Section Section			
40x40	2,44	020802	166,00
		020804	166,00
		020806	136,00

**Detalle de columna terminal.**  
Details of terminal column.  
Détail colonne terminal.

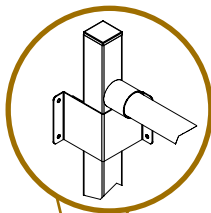

**Detalle de columna central.**  
Details of the central column.  
Détail colonne centrale.

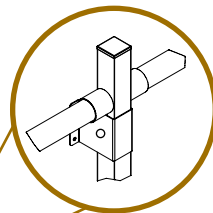

**Detalle de columna en esquina.**  
Details of the corner column.  
Détail colonne sur coin.

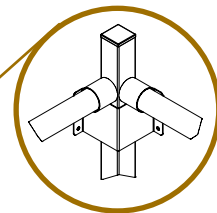

**Detalle de tubos transversales.**  
Details of the transversal pipes.  
Détail tubes transversales.

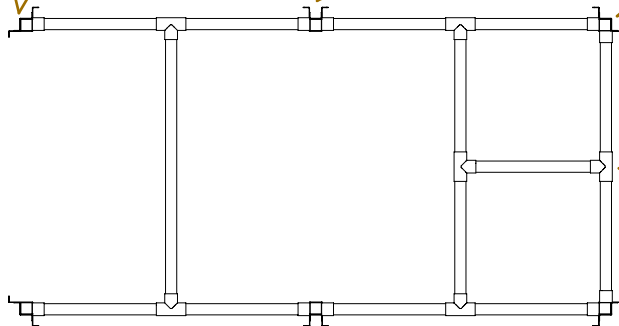
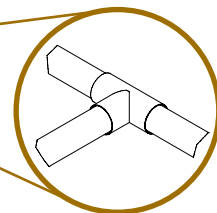

**Pletinas**  
Flat bars  
Platines

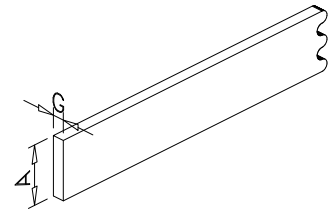

**Peso por metro.**  
Weight per meter.  
Poids par mètre.

Concepto Concept Concept		€
<b>Corte a medida</b> Custom cut Coupe sur mesure	021004	<b>4,00</b>
<b>Taladro</b> Drill hole Tariere	021002	<b>7,00</b>

					Precio 1 m. 1 m. price Prix 1 m.
A	G	Gr		€	
20	5	800	407808		<b>13,00</b>
30	5	1.200	407811		<b>19,00</b>
40	5	1.600	407816		<b>22,00</b>
40	6	1.920	407820		<b>25,00</b>
40	8	2.560	407828		<b>30,00</b>
40	10	3.200	407838		<b>37,00</b>
50	8	3.200	407832		<b>38,00</b>

**Tubos pulidos**  
Polished tubes  
Tubes polis

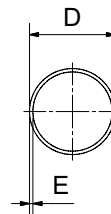

**Peso por metro.**  
Weight per meter.  
Poids par mètre.

Concepto Concept Concept		€
<b>Corte a medida</b> Custom cut Coupe sur mesure	021004	<b>4,00</b>
<b>Tapar extremos inox</b> Inox end cover Boucher extremes inox	021202	<b>25,00</b>

					Precio m m price Prix m
D	E	Gr		€	
10	1,0	227	406810		<b>5,00</b>
16	1,0	377	406824		<b>6,00</b>
20	1,5	695	407013		<b>8,00</b>
25	1,0	600	406832		<b>8,00</b>
25	1,5	885	407020		<b>11,00</b>
30	1,5	1.070	407028		<b>12,00</b>
30	2,0	1.400	407206		<b>15,00</b>
35	1,5	1.195	407036		<b>14,00</b>
38	1,5	1.370	407040		<b>15,00</b>
43	1,5	1.475	407048		<b>17,00</b>



**Peso por metro.**  
Weight per meter.  
Poids par mètre.



Existen tapones de plástico para tapar los extremos del tubo.  
There are plastic taps to cover the ends of the tube.  
Il y a des bouchers en plastic pour couvrir les bouts du tube.

**Ganchos forjados**  
 Forged hooks  
 Crochets forgés

		Uso Use Usage	D	H	E	L	✓	Gr	Barcode	€
	Cordero Lamb Agneau	8	55	8			10	750	920060102	<b>40,00</b>
	½ Ternera ½ Calf ½ Veau	10	70	8			1	140	021404	<b>8,00</b>
	Ternera Calf Veau	12	111	8			1	280	021406	<b>14,00</b>
	Vaca Cow Boeuf	16	135	8			1	505	021408	<b>26,00</b>

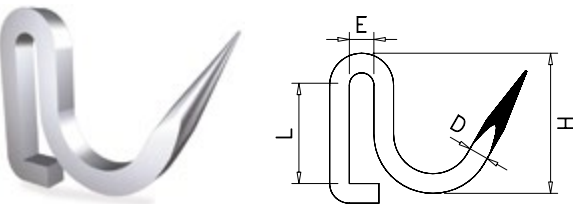
	Cordero Lamb Agneau	8	55	8	42		10	800	920060202	<b>90,00</b>
	½ Ternera ½ Calf ½ Veau	10	70	8	42		1	145	021604	<b>32,00</b>
	Ternera Calf Veau	12	105	8	42		1	290	021606	<b>42,00</b>
	Vaca Cow Boeuf	16	135	8	42		1	525	021608	<b>53,00</b>

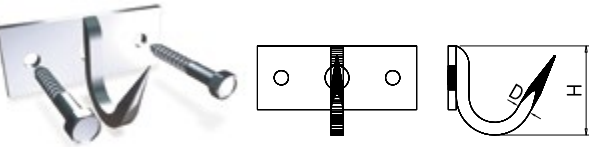
	Cordero Lamb Agneau	8	60				1	120	021802	<b>36,00</b>
	½ Ternera ½ Calf ½ Veau	10	70				1	170	021804	<b>40,00</b>
	Ternera Calf Veau	12	105				1	345	021806	<b>50,00</b>
	Vaca Cow Boeuf	16	135				1	665	021808	<b>59,00</b>

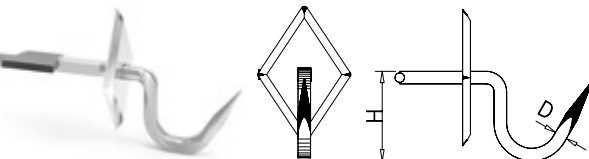
	Cordero Lamb Agneau	8	60				1	115	022002	<b>39,00</b>
	½ Ternera ½ Calf ½ Veau	10	70				1	150	022004	<b>42,00</b>
	Ternera Calf Veau	12	105				1	325	022006	<b>56,00</b>
	Vaca Cow Boeuf	16	135				1	645	022008	<b>71,00</b>

## Ganchos de varilla modelo " J "

Rod hooks " J " shaped  
Crochets à tige modèle " J "

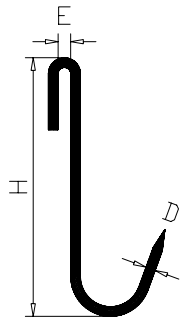

				Grosor de varilla Rod thickness Grosueur de la tige							
				D = 5 mm				D = 6 mm			
H	E	✓	Gr	Barcode	€	✓	Gr	Barcode	€		
50	9	10	200	9200603022202	<b>8,10</b>	10	350	9200603022216	<b>10,80</b>		
100	9	10	300	9200603022204	<b>8,30</b>	10	450	9200603022218	<b>11,10</b>		
120	9	10	350	9200603022206	<b>8,60</b>	10	500	9200603022220	<b>11,30</b>		
140	9	10	380	9200603022208	<b>8,80</b>	10	570	9200603022222	<b>11,40</b>		
160	9	10	400	9200603022210	<b>10,10</b>	10	600	9200603022224	<b>12,40</b>		
180	9	10	450	9200603022212	<b>11,70</b>	10	650	9200603022226	<b>13,70</b>		
200	9	10	500	9200603022214	<b>14,00</b>	10	700	9200603022228	<b>14,00</b>		

						Grosor de varilla Rod thickness Grosueur de la tige							
				D = 7 mm		D = 10 mm		D = 14 mm					
H	E	✓	Gr	Barcode	€	✓	Gr	Barcode	€	✓	Gr	Barcode	€
100	9	10	700	9200603022230	<b>15,40</b>								
120	9	10	750	9200603022232	<b>16,10</b>								
140	9	10	800	9200603022234	<b>17,50</b>	1	180	022242	<b>6,33</b>	1	340	022254	<b>10,53</b>
160	9	10	850	9200603022236	<b>18,90</b>	1	195	022244	<b>6,55</b>	1	355	022256	<b>11,41</b>
180	9	10	900	9200603022238	<b>20,30</b>	1	205	022246	<b>7,02</b>	1	365	022258	<b>12,29</b>
200	9	10	1000	9200603022240	<b>21,90</b>	1	220	022248	<b>7,02</b>	1	380	022260	<b>13,17</b>
230	9					1	235	022250	<b>7,02</b>	1	395	022262	<b>14,04</b>
260	9					1	260	022252	<b>7,02</b>	1	420	022264	<b>14,92</b>

## Gancho de varilla modelo " J "

Model " J " rod hook  
Crochet à tige modèle " J "

H	E	D	✓	Gr	Barcode	€							
55	8	5	10	250	9200608022266	<b>21,70</b>							
60	9	7	10	480	9200605022229	<b>9,60</b>							
100	9	5	1	51	022270	<b>1,52</b>							
160	9	5	1	73	022272	<b>1,62</b>							

## Ganchos de varilla modelo " S "

Rod hooks " S " shaped  
Crochets à tige modèle " S "

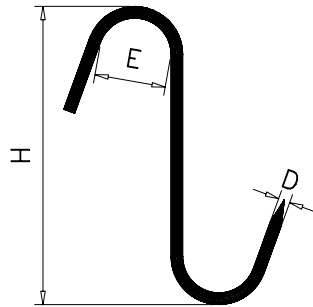

Grosor de varilla Rod thickness Grosueur de la tige						
D = 5 mm						
H	E	✓	Gr	Barcode	€	
100	30	10	300	9200604022404	<b>7,60</b>	
120	39	10	350	9200604022406	<b>8,80</b>	
140	39	10	450	9200604022408	<b>9,60</b>	
160	39	10	500	9200604022410	<b>10,00</b>	
180	39	10	550	9200604022412	<b>10,50</b>	
200	39	10	580	9200604022414	<b>11,10</b>	

Grosor de varilla Rod thickness Grosueur de la tige													
D = 6 mm						D = 7 mm				D = 10 mm			
H	E	✓	Gr	Barcode	€	✓	Gr	Barcode	€	✓	Gr	Barcode	€
120	39	10	550	9200604022416	<b>11,40</b>								
140	39	10	600	9200604022418	<b>11,70</b>								
160	39	10	700	9200604022420	<b>12,30</b>	10	950	9200604022426	<b>16,60</b>				
180	39	10	750	9200604022422	<b>13,30</b>	10	1050	9200604022428	<b>17,60</b>				
200	39	10	800	9200604022424	<b>15,40</b>	10	1100	9200604022430	<b>18,40</b>	1	255	022432	<b>5,76</b>
230	39									1	270	022434	<b>5,99</b>
260	39									1	290	022436	<b>6,28</b>

## Ganchos de varilla modelo " S "

" S " model rod hooks  
Crochets à tige modèle " S "

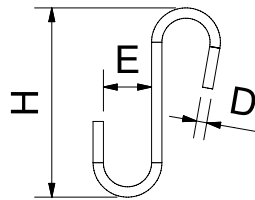

H	E	D	✓	Gr	Barcode	€
---	---	---	---	----	---------	---

60	16	3	10	40	9200606022502	<b>4,60</b>
----	----	---	----	----	---------------	-------------

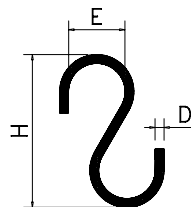

80	30	5	10	230	9200607022702	<b>7,30</b>
----	----	---	----	-----	---------------	-------------

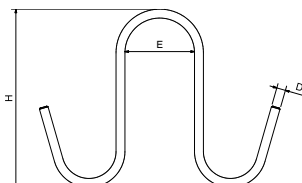

100	39	5	1	56	022438	<b>2,07</b>
-----	----	---	---	----	--------	-------------

160	39	5	1	76	022440	<b>2,17</b>
-----	----	---	---	----	--------	-------------



## Ganchos jamoneros

Ham hooks  
Crochets à jambon



H E D ✓ Gr €

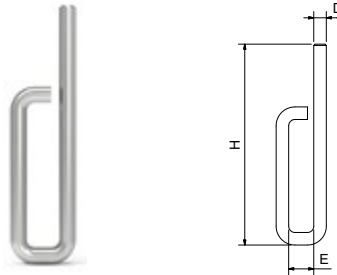

80 10 5 12 276 275233 **12,00**

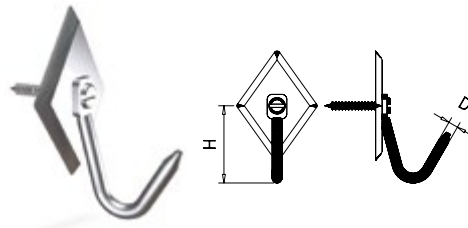

56 6 1 30 022602 **17,60**

## Gancho de varilla multifunción

Multifunctional rod hook  
Crochet à barre multifonctionnel

H E D ✓ Gr €

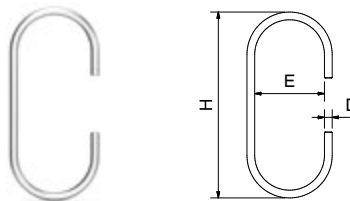

120 45 5 20 40 022510 **22,00**

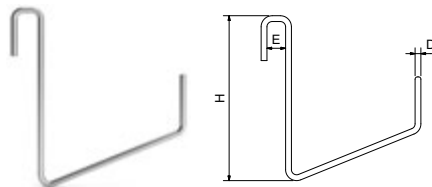

142 16 5 1 55 211920 **0,90**

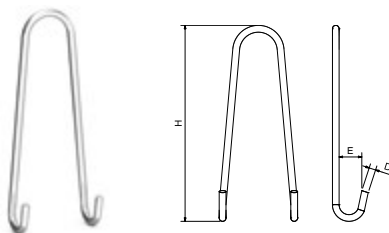

115 13 4 1 29 022520 **0,61**

## Ganchos salchicheros

Sausage hooks  
Crochets à saucisses

		L	A	H	E	Gr	Barcode	€		
		200	40	50	10	320	022802	<b>31,00</b>		
		300	40	50	10	415	022804	<b>41,00</b>		
		200	40	50	10	505	023002	<b>63,00</b>		
		300	40	50	10	685	023004	<b>75,00</b>		
		200				8	120	023202 <b>41,00</b>		
		215					145	40	170	023402 <b>28,00</b>
		130					170	39	80	023602 <b>25,00</b>

## Gancho giratorio

Revolving hook  
Crochet tournant

		H	E	D	Gr	Barcode	€
		280	18	12	380	422202	<b>21,50</b>
		240	56	10	260	422402	<b>14,00</b>

## Gancho de arrastre

Pulling hook  
Crochet d'entraînement

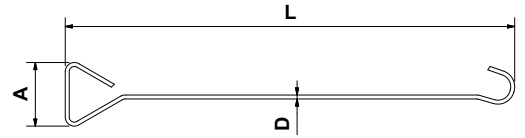

L	A	D	Gr	Barcode	€
760	107	7	301	023702	12,00

## Barra mural con ganchos

Wall mounted rack with hooks  
Barre dents de loup



Caractéristiques:  
Barre de 40x8 mm.  
Barre polie des 4 côtés.  
Crochets amovibles.  
Possibilité de mettre et enlever des crochets.  
Deux supports robustes pour la fixation au mur.

### Características:

Pletina de 40x8 mm.  
Pletina pulida a las cuatro caras.  
Ganchos movibles.  
Posibilidad de añadir y quitar ganchos.  
Dos robustos soportes para la sujeción a pared.

### Characteristics:

Bar of 40x8 mm.  
Polished on four sides.  
The hooks can be positioned.  
Possibility of removing or adding hooks.  
Wall fixation by 2 solid brackets.

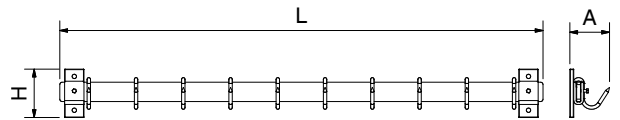

Gancho adicionales  
Additional hooks  
Crochets supplémentaires

H	E	D	Barcode
60	9	7	9200605022229

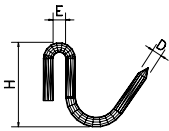

L	A	H	Nº Ganchos Hooks Crochets	Kg	Barcode	€
1.000	90	100	10	3,00	024220	109,00
1.500	90	100	10	4,00	024222	125,00

## Kit para colgar utensilios

Tool-holder kit  
Kit pour suspendre outils

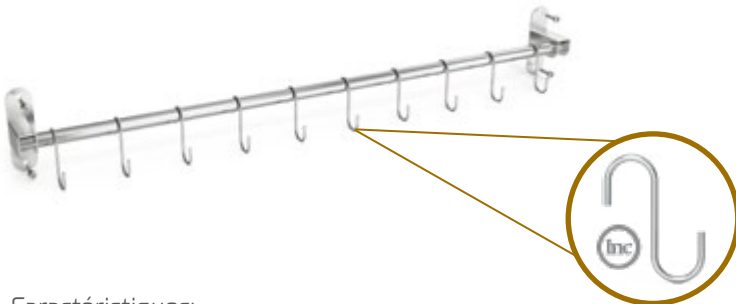

Caractéristiques:  
Construit tout en acier inox.  
Grande solidité.  
Pourvu avec 10 crochets (9200606022502).  
Il libère de l'espace sur le dessus.  
Possibilité de l'utiliser comme porte-serviette ou porte-couvercles de bacs et pots.  
Vis et ancrages pour fixation au mur inclus.

### Características:

Construido totalmente en acero inoxidable.  
Gran resistencia.  
Provisto de 10 ganchos (9200606022502).  
Incluye tornillos y tacos para fijar a la pared.  
Libera superficie de trabajo en la encimera.  
También se puede usar como toallero o para colgar las tapas de las cubetas y las ollas.

### Characteristics:

Totally made in stainless steel.  
High solidity.  
Provided with 10 hooks (9200606022502).  
It saves room on the worktop.  
It also can be used as a towel rail or to hold the lids of tanks and pots.  
Bolts and rawlplugs to fix onto the wall included.



Gancho adicionales  
Additional hooks  
Crochets supplémentaires

H	E	D	Barcode
60	16	3	9200606022502

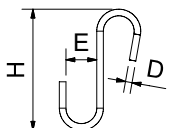

L	A	H	Nº Ganchos Hooks Crochets	Kg	Barcode	€
750	50	100	10	0,50	020102	37,00

**Tochos de hierro cincado rosca métrica**  
 Zinc-plated thick iron rods and metric threads  
 Goujons en fer zingué à filetage métrique

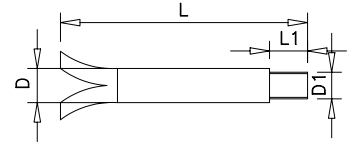

L	D	L1	D1	Gr	Barcode	€
150	18	20	M14	205	029802	<b>12,00</b>
200	18	20	M14	300	029804	<b>14,00</b>
250	18	20	M14	400	029806	<b>15,00</b>

**Soportes murales para tubo**  
 Wall supports for round tube  
 Supports muraux pour tube

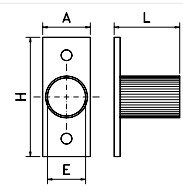

L	A	H	E	Gr	Barcode	€
45	40	100	30	190	026202	<b>27,00</b>
45	40	100	38	200	026204	<b>27,00</b>

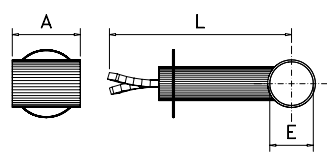

130	60	30	218	026402	<b>74,00</b>
130	60	38	233	026404	<b>74,00</b>
180	60	30	248	026406	<b>80,00</b>
180	60	38	263	026408	<b>80,00</b>
230	60	30	313	026410	<b>86,00</b>
230	60	38	328	026412	<b>86,00</b>

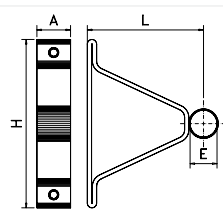

145	40	200	30	840	026602	<b>85,00</b>
149	40	200	38	855	026604	<b>85,00</b>
245	40	290	30	1.285	026606	<b>99,00</b>
249	40	290	38	1.300	026608	<b>99,00</b>

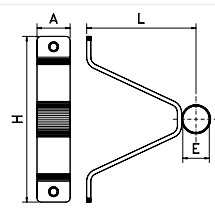

140	40	200	30	540	026802	<b>60,00</b>
144	40	200	38	550	026804	<b>60,00</b>
240	40	290	30	845	026806	<b>75,00</b>
244	40	290	38	855	026808	<b>75,00</b>

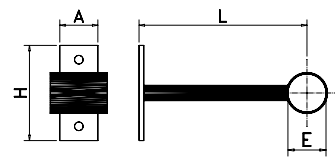











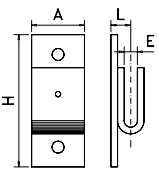

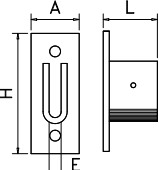
50	40	100	30	220	027002	<b>48,00</b>
50	40	100	38	280	027004	<b>48,00</b>
100	40	100	30	295	027006	<b>51,00</b>
100	40	100	38	310	027008	<b>51,00</b>
150	40	100	30	370	027010	<b>57,00</b>
150	40	100	38	385	027012	<b>57,00</b>
200	40	100	30	445	027014	<b>61,00</b>
200	40	100	38	460	027016	<b>61,00</b>

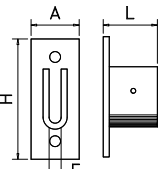
## Soportes murales para pletina

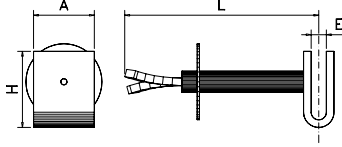
Wall supports for flat bar  
Supports muraux pour barre

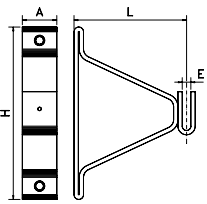
L A H E Gr  €

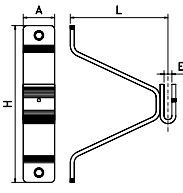

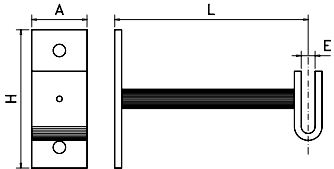
		18 40 100 10 345 024402 <b>27,00</b>
		45 40 100 10 345 024602 <b>27,00</b>
		45 40 100 10 345 024604 <b>27,00</b>
		130 40 50 10 320 024802 <b>74,00</b>
		180 40 50 10 350 024804 <b>80,00</b>
		230 40 50 10 455 024806 <b>86,00</b>
		140 40 200 10 975 025002 <b>85,00</b>
		240 40 290 10 1.385 025004 <b>99,00</b>
		135 40 200 10 645 025202 <b>60,00</b>
		235 40 290 10 935 025204 <b>75,00</b>
		50 40 100 10 325 025402 <b>48,00</b>
		100 40 100 10 400 025404 <b>51,00</b>
		150 40 100 10 475 025406 <b>57,00</b>
		200 40 100 10 550 025408 <b>72,00</b>

## Cadena eslabón largo según norma DIN 763 ø5 A4

Long link chain according to DIN 763 ø5 A4  
Chaîne à maillons longs selon DIN 763 ø5 A4

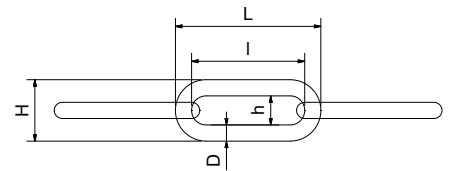

Precio 1 m.  
1 m. price  
Prix 1 m.

L	I	H	h	D	Gr	Barcode	€
45	35	19	9	5	420	420202	<b>8,00</b>

## Plafones para exposición de embutidos

Sausage display boards  
Panels d'exposition pour charcuterie

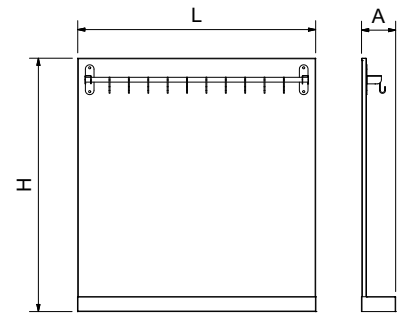

Gancho opcional 9200606022502  
Optional hook 9200606022502.  
Crochet optionnel 9200606022502.



46

L	A	H	✓	Kg	Barcode	€
800	115	850	10	6,22	024202	<b>195,00</b>
1.000	115	850	10	7,60	024204	<b>270,00</b>
1.500	115	850	10	11,26	024206	<b>290,00</b>

## Cartelas abatibles para estantes murales

Hinged brackets for wall shelves  
Consoles battante pour d'étagères murale



**\*HASTA 100 Kg  
por cartela**

Maximum load per  
bracket 100 Kgs.  
Charge maximale par  
console de 100 Kgs.

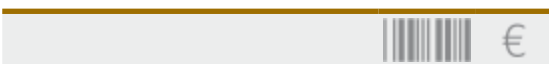
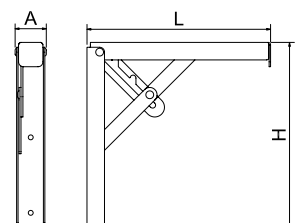

**Acoplar a estante inox**  
Coupled to stainless steel shelves  
Accouplé aux étagères en acier  
inoxydable

013204 **28,00**

**Acoplar a estante fibra**  
Coupled to polyethylene shelves  
Accouplé aux étagères en polyéthylène

013202 **7,00**

L	A	H	Kg	Barcode	€
300	30	210	0,40	421254	<b>42,50</b>

## Tirantes de techo

Ceiling rods  
Tringles de plafond

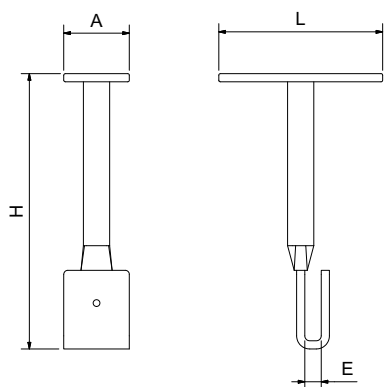

H	A	L	E	Gr	Barcode	€
100	40	100	10	360	025602	<b>68,00</b>
150	40	100	10	380	025604	<b>71,00</b>
200	40	100	10	400	025606	<b>75,00</b>
250	40	100	10	420	025608	<b>77,00</b>
300	40	100	10	440	025610	<b>79,00</b>
350	40	100	10	460	025612	<b>84,00</b>
400	40	100	10	480	025614	<b>86,00</b>
450	40	100	10	500	025616	<b>87,00</b>
500	40	100	10	520	025618	<b>91,00</b>
550	40	100	10	540	025620	<b>93,00</b>
600	40	100	10	560	025622	<b>96,00</b>
650	40	100	10	580	025624	<b>100,00</b>
700	40	100	10	600	025626	<b>101,00</b>
750	40	100	10	620	025628	<b>105,00</b>
800	40	100	10	640	025630	<b>107,00</b>
850	40	100	10	660	025632	<b>111,00</b>
900	40	100	10	680	025634	<b>114,00</b>
950	40	100	10	690	025636	<b>117,00</b>
1.000	40	100	10	695	025638	<b>120,00</b>



## Tirantes de techo con varilla roscada

Ceiling rods with thread  
Tringles de plafond avec filetage

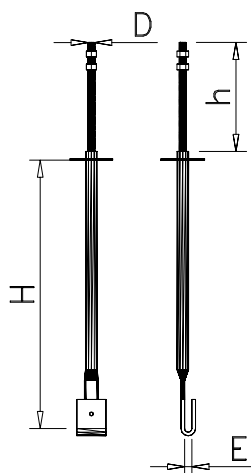

H	h	E	D	Gr	Barcode	€
100	150	10	M14	410	025802	<b>62,00</b>
150	150	10	M14	430	025804	<b>64,00</b>
200	150	10	M14	450	025806	<b>68,00</b>
250	150	10	M14	470	025808	<b>70,00</b>
300	150	10	M14	490	025810	<b>72,00</b>
350	150	10	M14	510	025812	<b>76,00</b>
400	150	10	M14	530	025814	<b>79,00</b>
450	150	10	M14	550	025816	<b>79,00</b>
500	150	10	M14	570	025818	<b>82,00</b>
550	150	10	M14	590	025820	<b>84,00</b>
600	150	10	M14	600	025822	<b>87,00</b>
650	150	10	M14	650	025824	<b>90,00</b>
700	150	10	M14	700	025826	<b>93,00</b>
750	150	10	M14	750	025828	<b>95,00</b>
800	150	10	M14	800	025830	<b>97,00</b>
850	150	10	M14	850	025832	<b>100,00</b>
900	150	10	M14	900	025834	<b>103,00</b>
950	150	10	M14	950	025836	<b>106,00</b>
1.000	150	10	M14	1.000	025838	<b>108,00</b>

## Tirantes de techo para tubo

Ceiling rods for round tube

Tringles de plafond pour tube

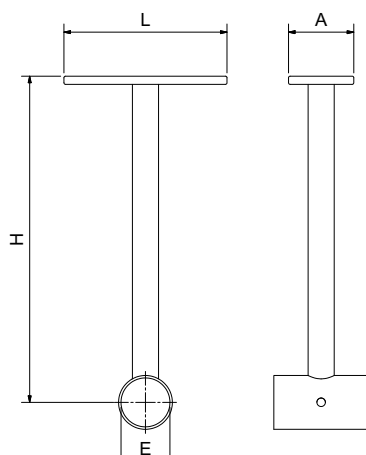

H	A	L	E	Gr	Barcode	€
100	40	100	30	300	027202	<b>68,00</b>
			38	320	027204	
150	40	100	30	330	027206	<b>71,00</b>
			38	350	027208	
200	40	100	30	360	027210	<b>75,00</b>
			38	380	027212	
250	40	100	30	390	027214	<b>77,00</b>
			38	410	027216	
300	40	100	30	420	027218	<b>79,00</b>
			38	440	027220	
350	40	100	30	450	027222	<b>84,00</b>
			38	470	027224	
400	40	100	30	480	027226	<b>86,00</b>
			38	500	027228	
450	40	100	30	510	027230	<b>87,00</b>
			38	530	027232	
500	40	100	30	540	027234	<b>91,00</b>
			38	560	027236	
550	40	100	30	570	027238	<b>93,00</b>
			38	590	027240	
600	40	100	30	600	027242	<b>96,00</b>
			38	620	027244	
650	40	100	30	630	027246	<b>100,00</b>
			38	650	027248	
700	40	100	30	660	027250	<b>103,00</b>
			38	680	027252	
750	40	100	30	690	027254	<b>105,00</b>
			38	710	027256	
800	40	100	30	720	027258	<b>107,00</b>
			38	740	027260	
850	40	100	30	750	027262	<b>111,00</b>
			38	770	027264	
900	40	100	30	780	027266	<b>114,00</b>
			38	800	027268	
950	40	100	30	810	027270	<b>117,00</b>
			38	830	027272	
1.000	40	100	30	840	027274	<b>120,00</b>
			38	860	027276	



## Tirantes de techo para tubo con varilla roscada

Ceiling rods with thread for round tube

Tringles de plafond avec filetage pour tube

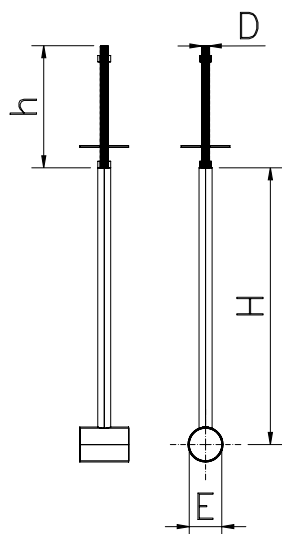
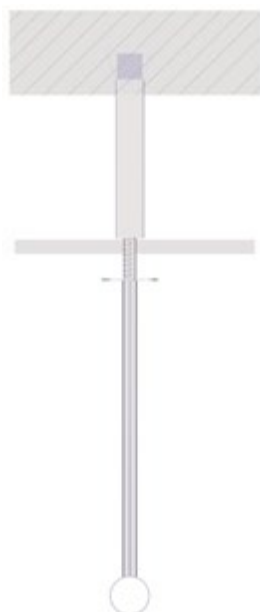

H	h	D	E	Gr	Barcode	€
100	150	M14	30	350	027402	<b>62,00</b>
			38	370	027404	
150	150	M14	30	380	027406	<b>64,00</b>
			38	400	027408	
200	150	M14	30	410	027410	<b>68,00</b>
			38	430	027412	
250	150	M14	30	440	027414	<b>70,00</b>
			38	460	027416	
300	150	M14	30	470	027418	<b>72,00</b>
			38	490	027420	
350	150	M14	30	500	027422	<b>76,00</b>
			38	520	027424	
400	150	M14	30	530	027426	<b>78,00</b>
			38	550	027428	
450	150	M14	30	560	027430	<b>79,00</b>
			38	580	027432	
500	150	M14	30	590	027434	<b>82,00</b>
			38	610	027436	
550	150	M14	30	620	027438	<b>84,00</b>
			38	640	027440	
600	150	M14	30	650	027442	<b>87,00</b>
			38	670	027444	
650	150	M14	30	680	027446	<b>90,00</b>
			38	700	027448	
700	150	M14	30	710	027450	<b>93,00</b>
			38	730	027452	
750	150	M14	30	740	027454	<b>95,00</b>
			38	760	027456	
800	150	M14	30	770	027458	<b>97,00</b>
			38	790	027460	
850	150	M14	30	800	027462	<b>100,00</b>
			38	820	027464	
900	150	M14	30	830	027466	<b>103,00</b>
			38	850	027468	
950	150	M14	30	860	027470	<b>106,00</b>
			38	880	027472	
1.000	150	M14	30	890	027474	<b>108,00</b>
			38	910	027476	



## Sujeciones de hierro para tirante

Iron fasteners for rod  
Fixations de fer pour tringle

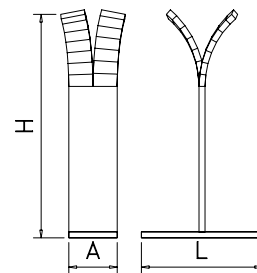

H	A	L	Gr	Barcode	€
100	40	100	240	028402	<b>25,00</b>
200	40	100	360	028404	<b>26,00</b>
300	40	100	480	028406	<b>27,00</b>
400	40	100	600	028408	<b>28,00</b>
500	40	100	720	028410	<b>29,00</b>
600	40	100	840	028412	<b>30,00</b>
700	40	100	960	028414	<b>32,00</b>
800	40	100	1.080	028416	<b>33,00</b>
900	40	100	1.200	028418	<b>34,00</b>
1.000	40	100	1.320	028420	<b>35,00</b>

## Garras galvanizadas para tirantes

Galvanized splayed rod clamp  
Griffes galvanisées pour tringle

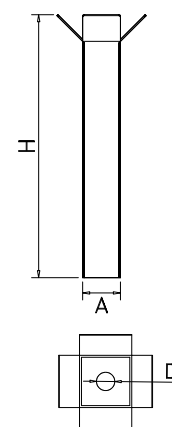

H	A	D	Gr	Barcode	€
100	40	M14	170	028602	<b>25,00</b>
200	40	M14	340	028604	<b>26,00</b>
300	40	M14	510	028606	<b>27,00</b>
400	40	M14	680	028608	<b>28,00</b>
500	40	M14	850	028610	<b>29,00</b>
600	40	M14	1.020	028612	<b>30,00</b>
700	40	M14	1.190	028614	<b>32,00</b>
800	40	M14	1.360	028616	<b>33,00</b>
900	40	M14	1.530	028618	<b>34,00</b>
1.000	40	M14	1.700	028620	<b>35,00</b>

## Tirante para balanzas regulable

Adjustable rod for hanging scales  
Tringle réglable pour balances suspendues



### Características:

Diseñado para adaptar la altura de la balanza a cada usuario.  
La regulación se realiza de una manera fácil, rápida y segura, sin tener que descolgar o desenchufar la balanza.  
Regulación 86 mm.  
Para tubo de  $\varnothing 38$  mm. arriba.  
Casquillo de  $\varnothing 40$  mm. en balanza.

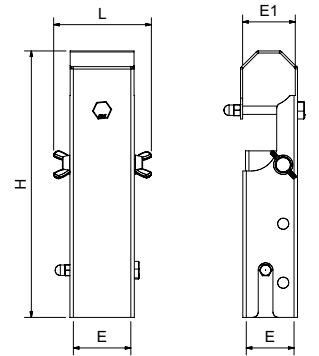

### Characteristics:

Designed to adjust the hanging scale at the desired height.  
The adjustment can be done in a quick, easy and safe way. You do not need to take down or unplug the scale.  
Adjustment: 86 mm.  
For upper tube of  $\varnothing 38$  mm.  
Scale ferrule of  $\varnothing 40$  mm.

### Caractéristiques:

Conçu pour régler la balance suspendue à la hauteur convenable.  
L'ajustement peut être fait de manière simple, rapide et en toute sécurité. Vous n'avez pas besoin de décrocher ou de débrancher la balance.  
Ajustement: 86 mm.  
Pour tube supérieur de  $\varnothing 38$  mm.  
Virole d'échelle de  $\varnothing 40$  mm.

H	L	E	E1	Gr	028250	€
192-234-277	70	$\varnothing 40$	$\varnothing 38$	500		50,00

## Tirante para colgar balanzas

Hanging rod for scales  
Tringle de suspension pour balances

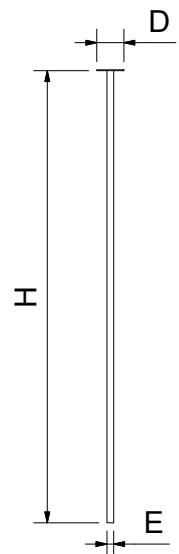

H	D	E	Gr	028262	€
2.000	120	30	600		139,00

## Tirantes para balanzas

Rods for scales  
Tringles pour balances

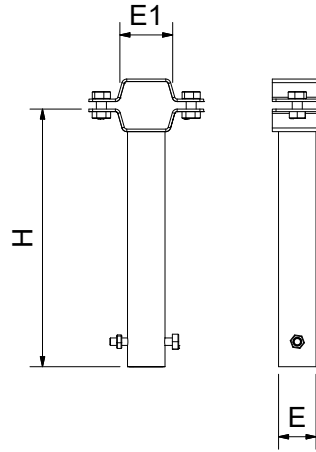

H	E	E1	Gr	Barcode	€
100	30	30	110	028202	<b>74,00</b>
		38	120	028204	
200	30	30	215	028206	<b>78,00</b>
		38	225	028208	
300	30	30	320	028210	<b>82,00</b>
		38	330	028212	
400	30	30	425	028214	<b>87,00</b>
		38	435	028216	
500	30	30	530	028218	<b>95,00</b>
		38	540	028220	
600	30	30	635	028222	<b>100,00</b>
		38	645	028224	
700	30	30	740	028226	<b>104,00</b>
		38	750	028228	
800	30	30	845	028230	<b>107,00</b>
		38	855	028232	
900	30	30	950	028234	<b>116,00</b>
		38	960	028236	
1.000	30	30	1.055	028238	<b>120,00</b>
		38	1.065	028240	

## Defensa de esquina tubular 90°

Bumper bar for corner 90°  
Pare-choc pour coin 90°



### Características:

Desmontable.  
Fabricadas en tubo de  $\varnothing 48.3$  mm.  
AISI 304.  
Fijación mediante casquillos.

### Characteristics:

Detachable.  
Made with tube  $\varnothing 48.3$  mm.  
AISI 304.  
Assembled by means of ferrules

### Caractéristiques:

Détachable.  
Fabriquées avec tube de  $\varnothing 48.3$  mm.  
AISI 304.  
Fixation par bagues.

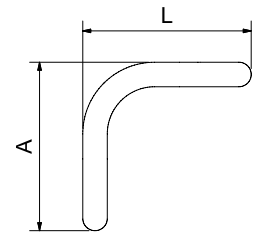
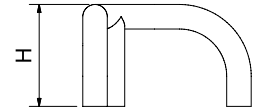

H	A	L	Gr	Barcode	€
220	340	340	1.150	425402	<b>240,00</b>

## Soportes de suelo

Floor supports  
Supports sur plancher

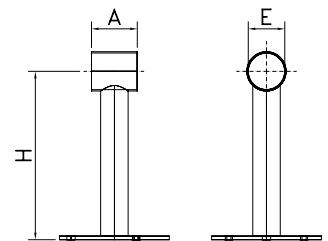
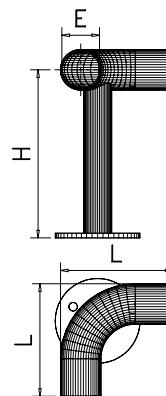

H	L	E	Gr	Barcode	€
200	90	30	695	029002	<b>86,00</b>
	210	38	990	029004	<b>90,00</b>
250	90	30	745	029006	<b>90,00</b>
	210	38	1.040	029008	<b>95,00</b>
300	90	30	795	029010	<b>95,00</b>
	210	38	1.090	029012	<b>98,00</b>

H	A	E	Gr	Barcode	€
200	50	30	600	028802	<b>55,00</b>
		38	630	028804	
250	50	30	650	028806	<b>58,00</b>
		38	680	028808	
300	50	30	700	028810	<b>63,00</b>
		38	730	028812	

## Parking para carros de la compra

Shopping trolley bay  
Parking pour caddies



Fabricado en acero inoxidable, este parking para carros de la compra es ideal para instalar en cualquier superficie que disponga de carros de la compra para el uso de sus clientes, ya sean pequeñas superficies de alimentación, supermercados, centros comerciales, etc.

Incorpora cadena de 500 mm para el anclaje del primer carro.

Made of stainless steel, this bay for shopping trolleys is ideal to be installed on any surface that has shopping carts ready to use for their customers, whether they are small food areas, supermarkets, shopping centers, etc.

It is provided with a 500 mm chain for securing the first trolley.

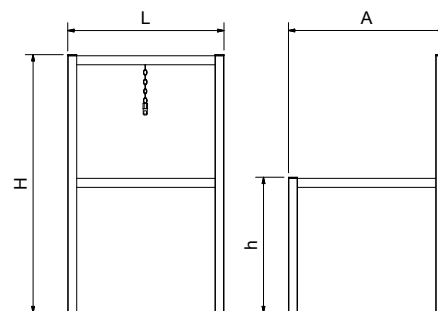

Fabriqué en acier inoxydable, ce parking pour caddies est idéal à installer sur toute surface dotée de caddies à l'usage de ses clients, qu'il s'agisse de petites aires de restauration, de supermarchés, de centres commerciaux, etc.

Il intègre une chaîne de 500 mm pour ancrer la première voiture.

L	A	H	h				€
695	695	1.140	602	1	7,50	081060	<b>246,00</b>
1.330	695	1.145	602	2	8,50	081062	<b>299,00</b>

## Plaqueta

Plate  
Plaque

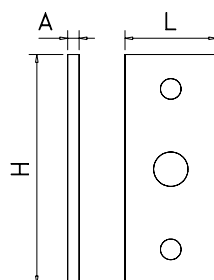

L	A	H			€
40	5	100	135	224602	<b>11,00</b>

Concepto	Concept	Concept		€
Plaqueta soldada	Soldered plate	Plaque soudée	029604	<b>30,00</b>

## Plaqueta redonda

Round plate  
Plaque ronde

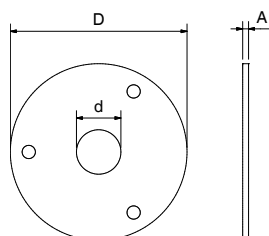

D	d	A			€
120	30	4	340	228806	<b>10,00</b>

### Soporte jamón RT

Ham holder RT  
Support jambon RT

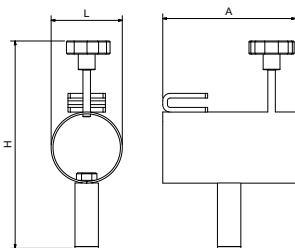

L	A	H	Gr	Barcode	€
75	140	220	800	041812	<b>68,00</b>

### Útil para sujeción de jamones

Ham holder tool  
Outil pour porter jambons

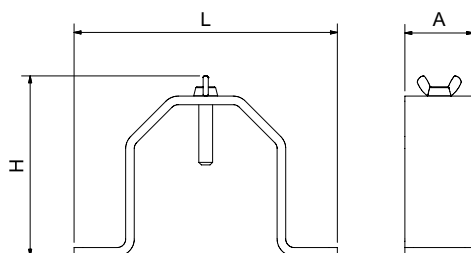

L	A	H	Gr	Barcode	€
153	40	105	400	024250	<b>110,00</b>

### Tubos en escuadra

Round tube at right angle  
Tube en cornière

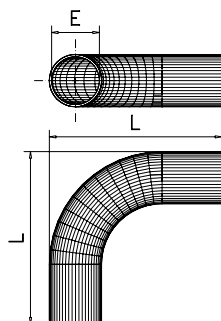

L	E	Gr	Barcode	€
90	30	195	429002	<b>23,00</b>
210	38	490	429004	<b>25,00</b>

### Tubos en forma de "T"

T-shaped round tube  
Tube dans "T"

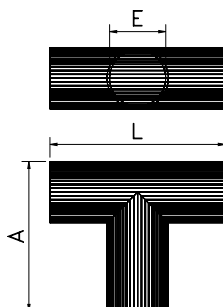

L	A	E	Gr	Barcode	€
110	70	30	160	425002	<b>36,00</b>
100	70	38	185	425004	<b>49,00</b>

### Cruces para tubo

Round tube intersections  
Intersections pour tube

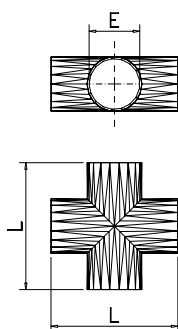

L	E	Gr	Barcode	€
112	30	210	425202	<b>83,00</b>
110	38	340	425204	<b>76,00</b>

**" U " sencilla**  
Simple " U "  
" U " simple

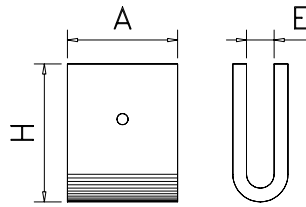

A	E	H	Gr	Barcode	€
40	10	50	155	029606	<b>12,00</b>

Concepto		Barcode	€
Concepto			
"U" sencilla soldada			
Soldered single "U"		029602	<b>39,00</b>
"U" simple soudée			



**" U " en doble T**  
" U " in double T  
" U " en double T

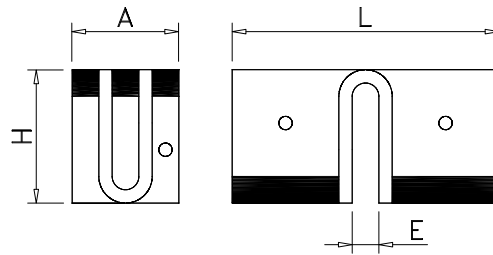

L	A	H	E	Gr	Barcode	€
100	40	50	10	445	029202	<b>86,00</b>

**" U " en forma de T**  
" U " in T  
" U " dans T

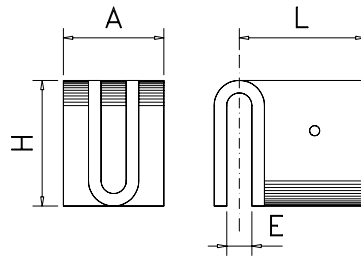

L	A	H	E	Gr	Barcode	€
50	40	50	10	295	029402	<b>39,00</b>

**" U " mixta en forma de T**  
T-shaped mixed " U "  
" U " mixte dans T

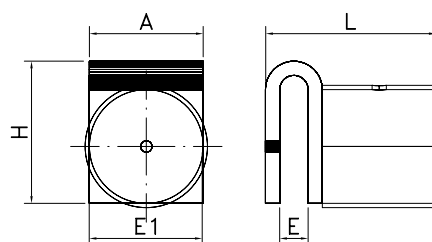

L	A	H	E	E1	Gr	Barcode	€
60	40	50	10	30	175	029302	<b>43,00</b>
60	40	50	10	38	180	029304	<b>48,00</b>

## Gancho pesador

Weighing hook  
Crochetspeseur



300 

### Características:

Peso en Kg., lb. y JIN  
Funciones: ON/OFF, Tara, fijación de peso automática  
Indicador de batería  
Desconexión automática  
Pantalla retroiluminada  
Nº de teclas: 3  
Pilas necesarias (no incluidas): 2xAAA  
Mosquetón de fijación superior y gancho abierto inferior.



### Characteristics:

Weighing in Kg., lb and JIN  
Functions: ON/OFF, Tare, Automatic weight-fixation  
Battery indicator  
Auto switch off  
Backlighted display  
Number of buttons: 3  
Batteries required (non included): 2 x AAA  
Upper carabiner and lower open hook included.

### Caractéristiques:

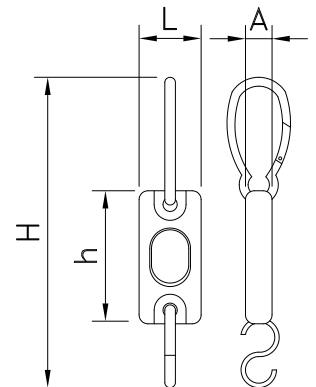
Poids en Kg., lb et JIN  
Fonctions: ON/OFF, Tara, Fixation du poids automatique.  
Témoin de batterie  
Mise en veille automatique  
Ecran retro-eclairé  
Nombre de touches: 3  
Piles requises (non incluses): 2 x AAA  
Mousqueton supérieur et crochet inférieur ouvert inclus.





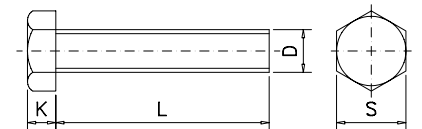

L	A	H	h				€
65	35	290	150	300	365	422604	<b>65,00</b>

## Tornillos cabeza hexagonal rosca métrica

Bolts with hexagonal head and metric threads  
Vis de tête hexagonale à filetage métrique



L	D	S	K			€
16	M4	7	2,8	3,0	421002	<b>0,10</b>
35	M4	7	2,8	6,0	421003	<b>0,15</b>
8	M5	8	3,5	0,7	421004	<b>0,11</b>
12	M5	8	3,5	1,0	421006	<b>0,12</b>
12	M6	10	4,0	3,0	421007	<b>0,13</b>
40	M6	10	4,0	8,0	421008	<b>0,20</b>
50	M6	10	4,0	9,0	421010	<b>0,23</b>
12	M8	13	5,3	7,0	421012	<b>0,20</b>
16	M8	13	5,3	8,0	421014	<b>0,23</b>

L	D	S	K			€
25	M8	13	5,3	11,0	421016	<b>0,25</b>
40	M8	13	5,3	15,0	421018	<b>0,28</b>
50	M8	13	5,3	18,0	421020	<b>0,35</b>
60	M8	13	5,3	21,0	421022	<b>0,44</b>
80	M8	13	5,3	27,0	421024	<b>0,67</b>
100	M8	13	5,3	33,0	421026	<b>0,80</b>
70	M10	17	6,4	40,0	421028	<b>0,71</b>
80	M10	17	6,4	44,0	421030	<b>0,75</b>
100	M10	17	6,4	56,0	421032	<b>0,78</b>



## Tornillos barraqueros con embellecedor

Blind nut with self-tapping bolts  
Ecroû de trou borgne à vis à bois

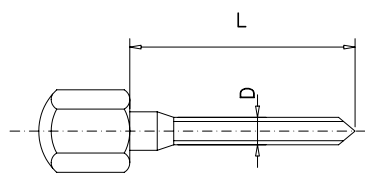

L	D	Gr	Barcode	€
40	6	20	029702	<b>2,80</b>
65	10	30	029704	<b>23,00</b>



## Tirafondos cabeza hexagonal

Bolts with hexagonal head  
Tire-fond de tête hexagonale

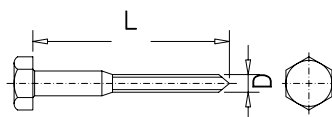

L	D	Gr	Barcode	€
40	6	10	421034	<b>0,30</b>
55	6	15	421035	<b>0,50</b>
60	8	20	421036	<b>0,90</b>
70	6	20	421033	<b>0,64</b>

## Tornillos rosca chapa

Self-tapping screws  
Vis filetage tôle

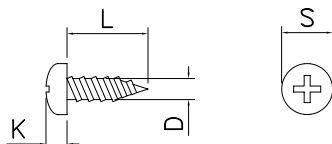

L	D	S	K	Gr	Barcode	€
10	3,5	7,0	2,00	1,0	421042	<b>0,08</b>
19	3,9	7,5	2,80	2,0	421039	<b>0,10</b>
22	5,5	10,5	4,10	6,0	421037	<b>0,20</b>
22	4,8	9,5	3,55	3,0	421038	<b>0,15</b>
32	3,9	7,5	2,80	2,2	421040	<b>0,12</b>

## Tornillo cabeza allen rosca métrica

Screw with allen head and metric thread  
Vis avec tête allen et fillet métrique

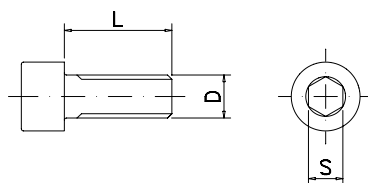

L	D	S	Gr	Barcode	€
12	M6	5	12	421043	<b>0,25</b>
25	M10	8	25	421044	<b>0,50</b>

## Tacos de plástico nylon

Nylon-plastic plug  
Cheville en plastic-nylon

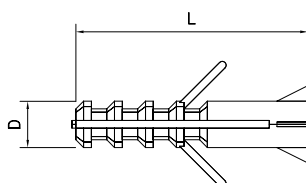

D	L	Barcode	€
6	30	409822	<b>0,11</b>
8	40	409824	<b>0,13</b>
10	50	409826	<b>0,32</b>

### Tornillo pasante con tuerca y contratuerca rosca métrica

Screw with nut and conternut with metric threads  
Vis perçante avec écrou et cotre-écrou à filetage métrique

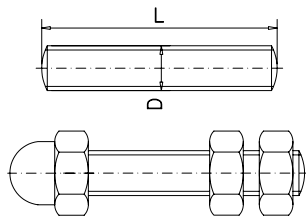

L	D	Gr	Barcode	€
200	M8	80	029502	<b>7,00</b>

### Tornillo cabeza mariposa tipo americano

American shape wing screw  
Vis à oreilles type américain

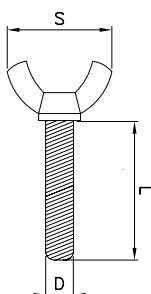

S	L	D	Gr	Barcode	€
30	25	8	17,00	421047	<b>1,50</b>
30	50	8	17,26	421046	<b>1,60</b>

### Taco galvanizado para techo tipo balancín

Galvanized ceiling rocker plug  
Cheville galvanisé pour toit modèle balancier

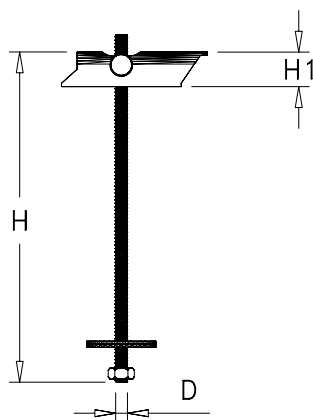

H	H1	D	Gr	Barcode	€
200	20	M8	135	421422	<b>16,00</b>

### Varillas roscadas rosca métrica

Rod with metric threads  
Tige spirale à filetage métrique

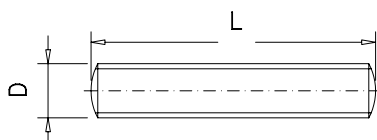

L	D	Gr	Barcode	€
1.000	M8	310	421202	<b>5,95</b>
1.000	M10	495	421204	<b>6,00</b>

### Embellecedor para tocho

Blind nut and metric threads  
Ecrou de trou borgne à filetage métrique

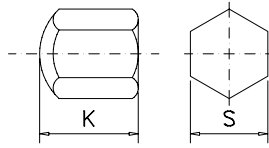

D	S	K	Gr	Barcode	€
M14	22	25	50	029902	<b>5,50</b>



### Tuercas ciegas hexagonales rosca métrica

Hexagonal acorn nuts with thread  
Ecrus borgne hexagonale à filetage métrique

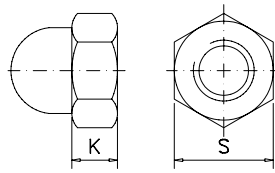

D	S	K	Gr	Barcode	€
M4	7	3,5	1	421064	<b>0,27</b>
M5	8	3,5	2	421066	<b>0,30</b>
M8	13	5,3	8	421070	<b>0,56</b>
M10	17	6,5	18	421072	<b>1,12</b>
M14	22	8,8	35	421076	<b>5,11</b>

### Tuerca ciega hexagonal con autoseguro

Hexagon self-locking nut with cup  
Ecrou borgne hexagonal avec auto-sécurité

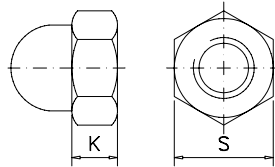

D	S	K	Gr	Barcode	€
M6	10	5	4	421068	<b>0,79</b>

### Tuercas hexagonales rosca métrica

Hexagonal nuts with thread  
Ecrus hexagonale à filetage métrique

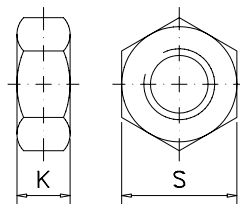

D	S	K	Gr	Barcode	€
M4	7	2,8	0,7	421050	<b>0,12</b>
M5	8	3,5	1	421052	<b>0,36</b>
M6	10	4,0	2	421054	<b>0,58</b>
M8	13	5,3	4	421056	<b>0,12</b>
M10	17	6,5	10	421058	<b>0,26</b>
M12	19	10,0	16	421060	<b>0,34</b>
M14	22	8,8	22	421062	<b>0,39</b>

### Tuerca hexagonal rosca metrica con autoseguro

Hexagonal nut with metric thread and lock  
Ecrou hexagonale autobloquant à filletage métrique

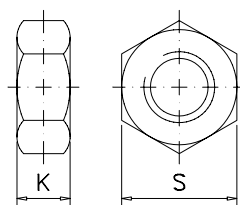

D	S	K	Gr	Barcode	€
M5	8	5,0	1	421078	<b>0,44</b>
M6	10	6,0	2	421080	<b>0,66</b>

## Tuerca mariposa tipo americano

American shape wing nut  
Écrou à oreilles type américain

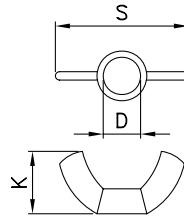

S	K	D	Gr	Barcode	€
30	15	M8	5,6	421082	<b>0,49</b>

## Remaches tubulares

Tubular rivets  
Rivetages tubulaires

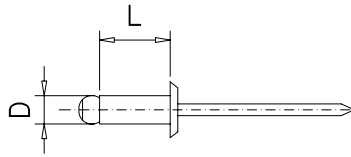

L	D	Gr	Barcode	€
10	3,2	1	421230	<b>0,19</b>
8	4,8	2	421233	<b>0,39</b>

## Bisagra de piano inox

Piano hinge  
Charnière de piano



L	A	Gr	Barcode	€
1.820	38	1.200	421250	<b>99,00</b>

## Arandelas

Plain washer  
Rondelle plate



Typo	D	D ext.	Gr	Barcode	€
Plana Plane Plain	M6	12,0	1,0	421215	<b>0,05</b>
	M8	16,0	2,0	421216	<b>0,06</b>
	M10	20,0	3,0	421218	<b>0,17</b>
	M12	19,5	2,7	421206	<b>0,09</b>
	M20	37,0	14,0	421220	<b>0,44</b>
Especial Special Special	M8	24,0	5,0	421221	<b>0,15</b>
	M10	30,0	11,0	421223	<b>0,26</b>
	M12	30,0	25,0	421208	<b>1,00</b>
	M20	60,0	64,0	421222	<b>1,00</b>
Grower Grower Grower	M4	6,2	0,2	421210	<b>0,03</b>
	M5	9,2	0,3	421212	<b>0,03</b>
	M8	14,8	1,0	421214	<b>0,06</b>
	M10	18,1	2,5	421213	<b>0,08</b>



# TAJOS

CHOPPING BLOCKS AND FIBRE BOARDS  
BILLOTS DE DÉCOUPE ET PLAQUES

**NOVEDADES**  
NEWS  
NOUVEAUTÉS



77





#### Detalle de portacuchillos de chapa y papelera adosados a tajo de troceo.

Detail of knife-holder in stainless steel sheet and wastepaper bin fixed to chopping block.  
 Détail de porte-couteaux en plaque et de corbeille à papier adapté au billot.

### Manufacturing characteristics of all our blocks:

Frame constructed from stainless steel.

Shelves made from acoustically treated stainless steel sheet, with no wood fitted internally.

Adjustable legs for a higher stability on any surface

Optionally, the following accessories can be installed:



Drawers	492
Knives disinfectants	370
Lateral wastepaper bin	394
Knife holders	136
Wheels	496
Lateral waste receptacle for scraps	74
Antivibrator cover for adjustable blocks	499
Coloured fibres	75

## Características de fabricación de todos nuestros tajos:

Bastidor construido en tubo de acero inoxidable.

Entrepaño en chapa de acero inoxidable insonorizado y sin madera pegada en su interior.

Pies regulables para una mayor estabilidad en cualquier tipo de suelo.

Opcionalmente se pueden instalar los siguientes accesorios:



Cajones	492
Esterilizadores de cuchillos	370
Papelera lateral	394
Portacuchillos	136
Ruedas	496
Tolva lateral evacuación de desperdicios	74
Funda antivibradora para taco regulable	499
Fibras de colores	75



### Caractéristiques de fabrication de tous nos billots:

Châssis fabriqué en tube d'acier inoxydable.

Tablettes fabriquées en plaque d'acier inoxydable insonorisées et sans bois collé à l'intérieur.

Pieds réglables pour une plus grande stabilité sur n'importe quelle surface.

Optionnellement on peut installer les suivantes accessoires:



Tiroirs	492
Désinfectants de couteaux	370
Corbeille à papier latéral	394
Porte couteaux	136
Roues	496
Trémie latéral d'évacuation des déchets	74
Base anti-vibrateur pour taquets réglables	499
Plaques de couleurs	75



#### Detalle de rueda de acero inoxidable con freno acoplada a pata de tajo de troceo.

Detail of wheel in stainless steel with brake fixed to chopping block leg.  
 Détail de roue en acier inoxydable avec frein installé dans pied de billot.



#### Detalle de pata con pie regulable con funda antivibradora.

Detail of adjustable feet with antivibrator cover.  
 Détail de pie réglable avec base anti-vibrateur.

## Tajos de troceo de fibra lastrados

Weighted butcher blocks with polyethylene  
Billots lestés en fibre



### Características:

Sistema de lastrado que garantiza una mayor higiene. Los tajos blindados y lastrados Fricosmos están especialmente diseñados para sustituir las mazas y tajos de madera, principalmente por las siguientes cualidades: Fibra polietileno calidad P-500 de 50 mm de grosor. Mayor peso, que evitará en gran medida el sonido y las vibraciones al ser golpeado, favoreciendo la estabilidad.

### Characteristics:

Ballasting system that guarantees better hygiene. The reinforced, weighted Fricosmos chopping blocks are especially designed to replace the wooden chopping blocks and boards mainly because of the following qualities: P-500 quality and 50mm thick polyethylene fibre. Its heaviness reduces noise and vibrations and keeps it steady.

### Caractéristiques:

Système de lestage qui garantit une plus grande hygiène. Les billots blindés et lestés Fricosmos sont spécialement préparés pour remplacer les troncs d'arbres et les billots en bois, grâce surtout à leurs qualités: Plaque de polyéthylène qualité P-500 de 50 mm d'épaisseur. Poids solide, qui évitera en grande mesure le bruit et les vibrations au moment de frapper, ce qui favorise la stabilité.

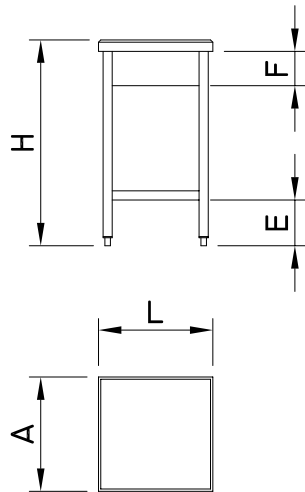

Es posible suministrarlos con fibra de diferente color. (Consultar)  
There is the possibility of supplying them with other colours of fibre. (Ask for it)  
Possibilité d'en fournir avec autres couleurs de fibre. (Demandez)

L	A	H	F	E		Kg		€
400	400	900	145	200		31,0	030102 030152	<b>389,00</b>
450	450	900	145	200		38,0	030104 030154	<b>441,00</b>
500	500	900	145	200		41,0	030106 030156	<b>474,00</b>
600	400	900	145	200		39,0	030108 030158	<b>505,00</b>
700	500	900	145	200		51,0	030110 030160	<b>631,00</b>
1.000	500	900	145	200		67,0	030112 030162	<b>964,00</b>

## Tajos de troceo de fibra con faldón

Butcher blocks with polyethylene and skirt  
Billots en fibre avec support à pan

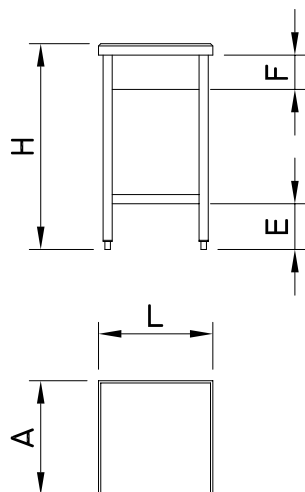

Es posible suministrarlos con fibra de diferente color. (Consultar)  
There is the possibility of supplying them with other colours of fibre. (Ask for it)  
Possibilité d'en fournir avec autres couleurs de fibre. (Demandez)

### Características:

Los tajos de fibra Fricosmos incorporan de serie polietileno calidad P-500 de 50 mm de grosor.

### Characteristics:

Fricosmos fibre blocks come as standard with P-500 quality and 50 mm thick polyethylene.

### Caractéristiques:

Les billots en fibre Fricosmos incorporent de série polyéthylène de qualité P-500 de 50 mm d'épaisseur.

L	A	H	F	E		Kg		€
400	400	900	145	200		15,1	030302 030352	<b>341,00</b>
450	450	900	145	200		17,8	030304 030354	<b>370,00</b>
500	500	900	145	200		20,9	030306 030356	<b>381,00</b>
600	400	900	145	200		20,3	030308 030358	<b>410,00</b>
700	500	900	145	200		27,3	030310 030360	<b>500,00</b>
1.000	500	900	145	200		36,9	030312 030362	<b>603,00</b>

## Tajo de troceo de fibra serie GE

Butcher blocks with polyethylene, GE series  
Billot en fibre, modèle GE



### Características:

Este tajo incorpora de serie polietileno calidad P-500 de 70 mm de grosor.

### Characteristics:

Fricosmos fibre blocks come as standard with P-500 quality and 70 mm thick polyethylene.

### Caractéristiques:

Les billots en fibre Fricosmos incorporent de série polyéthylène de qualité P-500 de 70 mm d'épaisseur.



040602 86,00 136

Portacuchillos para adosar con  
envolvente.

Mounted knife holder with casing  
Porte-couteaux pour adosar avec  
enveloppant

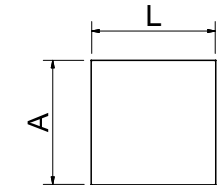
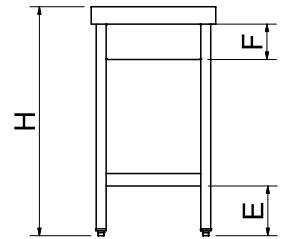

L	A	H	F	E		Kg		€
500	500	920	145	200		25,90	032008	<b>456,00</b>
500	500	920	145	200		25,90	032010	<b>456,00</b>
500	500	920	145	200		25,90	032012	<b>456,00</b>

## Tajo especial barbacoa

Butcher block, especially for barbecues  
Billot spécial pour barbecues



### Contenido:

- 1 Soporte de acero inoxidable con faldón y entrepaño.
- 1 Fibra de polietileno alta densidad. Dimensiones 600x400x50 mm.
- 1 Estante de apoyo de 325x325 mm, de acero inoxidable
- 1 Kit para utensilios de acero inoxidable con 10 ganchos.
- 1 Cestillo porta-objetos de 105x105x145 mm.
- 1 Adaptador para contenedor de desperdicios, de acero inoxidable.
- 1 Contenedor de desperdicios de 26 lbs.
- 2 Ruedas giratorias sin freno, de acero inoxidable y superficie de rodadura de nylon.
- 2 Ruedas giratorias con freno, de acero inoxidable y superficie de rodadura de nylon.

### Content:

- 1 frame of stainless steel with fringe and shelf.
- 1 high density polyethylene board, dimensions 600x400x50 mm.
- 1 stainless steel shelf for support of 325x325 mm.
- 1 tool holder kit in stainless steel with 10 hooks.
- 1 tool holder basket of 105x105x145 mm.
- 1 waste bin container adaptor in stainless steel.
- 1 waste bin container of 26 liters
- 2 revolving wheels in stainless steel, without brakes and rolling surface in nylon.
- 2 revolving wheels in stainless steel, with brakes and rolling surface in nylon.

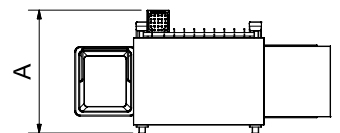
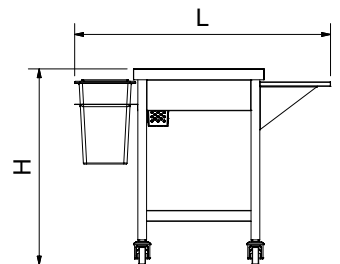

### Contenu:

- 1 châssis en acier inoxydable avec support à pan et étage.
- 1 plaque en polyéthylène d'haute densité et dimensions 600x400x50 mm
- 1 étagère en acier inoxydable de 325x325 mm pour appui des objets
- 1 kit pour suspendre outils en acier inoxydable avec 10 crochets.
- 1 panier pour suspendre objets de 105x105x145 mm
- 1 adaptateur en acier inoxydable pour conteneur à ordures.
- 1 conteneur à ordures de 26 litres
- 2 rouelles pivotantes en acier inoxydable, sans frein et surface roulante en nylon.
- 2 rouelles pivotantes en acier inoxydable, avec frein et surface roulante en nylon.



Es posible suministrarlos con fibra de diferente color. (Consultar)

There is the possibility of supplying them with other colours of fibre. (Ask for it)  
Possibilité d'en fournir avec autres couleurs de fibre. (Demandez)

L	A	H	Kg		€
1.175	565	900	28,5	032002	<b>656,00</b>



## Tajos de troceo madera con faldón

Butcher blocks with wood and skirt  
Billots en bois avec support inox

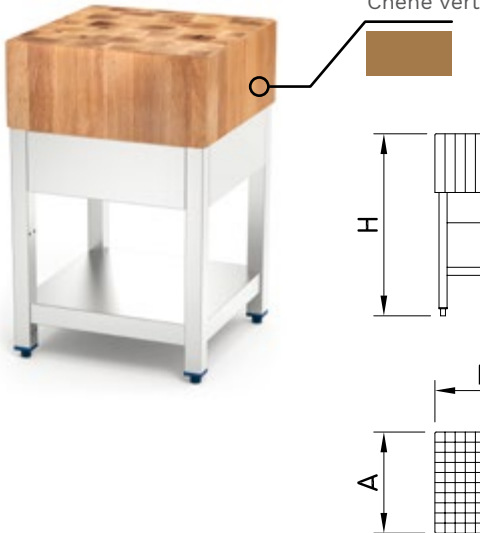
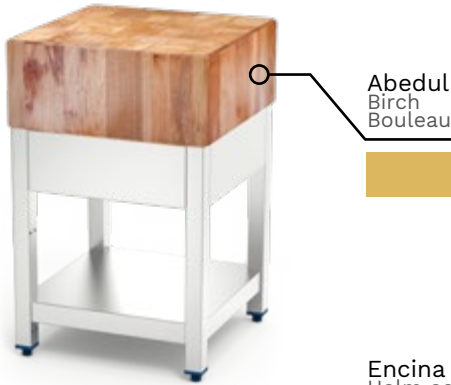

### Características:

Los tajos de madera Fricosmos incorporan de serie una maza construida con tacos de madera de abedul o encina de 250 mm de espesor.

### Characteristics:

Fricosmos wooden blocks come as standard with wooden mass constructed with blocks of birch or holm oak 250 mm thick.

### Caractéristiques:

Les billots en bois Fricosmos incorporent de série un bloc fabriqué avec morceaux de bois bouleau ou de chêne vert de 250 mm d'épaisseur.

L	A	H	F	E		Kg		€
400	400	900	145	150		36	031102	<b>419,00</b>
						46	031502	<b>591,00</b>
450	450	900	145	150		45	031104	<b>462,00</b>
						58	031504	<b>684,00</b>
500	500	900	145	150		54	031106	<b>512,00</b>
						69	031506	<b>758,00</b>
600	400	900	145	150		52	031108	<b>512,00</b>
						67	031508	<b>758,00</b>
700	500	900	145	150		75	031110	<b>620,00</b>
						96	031510	<b>962,00</b>
1.000	500	900	145	150		105	031112	<b>945,00</b>
						136	031512	<b>1.324,00</b>

## Tajos de troceo madera y fibra con faldón

Butcher blocks with polyethylene, wood and skirt  
Billots en bois et en fibre avec support inox



### Características:

Los tajos de madera y fibra Fricosmos incorporan de serie polietileno calidad P-500 de 50 mm de grosor y maza construida con tacos de madera de abedul de 200 mm de espesor.

### Characteristics:

Fricosmos wooden and fibre chopping blocks come as standard with P-500 quality and 50 mm thick polyethylene and wooden mass constructed with birch blocks of 200 mm thick.

### Caractéristiques:

Les billots en bois et en fibre Fricosmos incorporent de série Polyéthylène qualité P-500 de 50 mm d'épaisseur et bloc fabriqué avec morceaux de bois bouleau de 200 mm d'épaisseur.

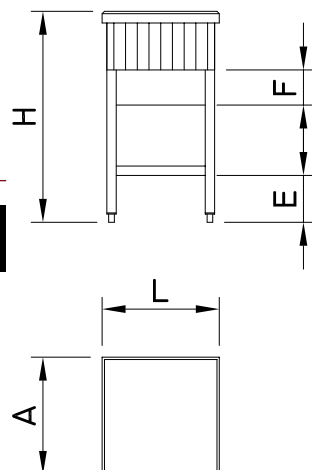

Es posible suministrarlos con fibra de diferente color. (Consultar)

There is the possibility of supplying them with other colours of fibre. (Ask for it)  
Possibilité d'en fournir avec autres couleurs de fibre. (Demandez)

L	A	H	F	E		Kg		€
400	400	900	145	150		30,0	030702	<b>465,00</b>
							030752	
450	450	900	145	150		40,0	030704	<b>573,00</b>
							030754	
500	500	900	145	150		41,0	030706	<b>597,00</b>
							030756	
600	400	900	145	150		52,3	030708	<b>606,00</b>
							030758	
700	500	900	145	150		56,0	030710	<b>703,00</b>
							030760	
1.000	500	900	145	150		106,9	030712	<b>1.121,00</b>
							030762	

## Tajo con sistema de elevación

Butcher block with lifting system  
Billot avec système d'élévation



Tajo de corte fabricado en acero inoxidable que incorpora una maza de madera de abedul de 200 mm de espesor y una fibra de polietileno rojo de 50 mm de espesor.

Están diseñados especialmente para el corte de alimentos aportando resistencia y fiabilidad.

Este modelo además incorpora un sistema de elevación que permite regular la altura de la superficie de trabajo.

¿Por qué hemos diseñado un tajo que se pueda regular en altura? Nuestras premisas principales han sido: la ergonomía, la reducción de enfermedades laborales y de accidentes de trabajo.

Con esta utilidad, su personal, independientemente de su altura, podrá adaptar el centro de trabajo a las necesidades particulares, realizando su jornada diaria mucho más cómoda y segura, evitará malas posturas y en gran medida, posibles accidentes o lesiones. Este sistema se adapta perfectamente a suelos con caída o desnivel, estando la encimera siempre horizontal.

La regulación posible es de 200 mm hacia arriba o hacia abajo, siendo la altura mínima total de 805 mm y la máxima total de 1005 mm. Resistencia y durabilidad garantizada.

Structure made of stainless steel that incorporates a block of birch wood 200 mm thick and a red polyethylene fiber 50 mm thick.

They are specially designed for food cutting providing strength and reliability. This model also incorporates a lifting system that allows to regulate the height of the work surface.

Why have we designed a butcher's block that can be adjusted in height? Our main principles have been: ergonomics and the reduction of occupational diseases and accidents at work.

With this utility, your staff, regardless of their height, can adapt the workplace to particular needs, making their daily work much more comfortable and safer, avoid bad postures and to a large extent, possible accidents or injuries. This system adapts perfectly to floors with fall or unevenness, being the countertop always horizontal.

The possible adjustment is 200 mm upwards or downwards, with a total minimum height of 805 mm and a total maximum height of 1005 mm. Strength and durability guaranteed.

Billot pour découpe fabriqué en acier inoxydable qui inclut un bloc en bois de bouleau de 200mm d'épaisseur et une plaque de polyéthylène rouge de 50mm d'épaisseur.

Spécialement conçu pour la découpe des aliments offrant résistance et fiabilité.

Ce modèle intègre également un système d'élévation qui permet de régler la hauteur de la surface de travail.

Pourquoi avons-nous conçu un billot réglable en hauteur? Nous avons pris en compte les suivants facteurs: ergonomie, réduction des maladies professionnelles et des accidents du travail.

Avec cet exemplaire, votre personnel, quelle que soit sa taille, peut adapter le lieu de travail à ces besoins particuliers, réalisant son travail quotidien de forme plus confortable et sûre, évitant les mauvaises positions et en outre mesure les possibles accidents ou blessures.

Ce système s'adapte parfaitement aux sols avec pente ou irrégularité, le plan de travail étant toujours horizontal.

Le réglage possible est de 200mm vers le haut ou vers le bas, la hauteur totale minimale étant de 805mm et la hauteur totale maximale étant de 1005mm.

Résistance et durabilité garanties.



Mas información en fricosmos.com

Mas información en fricosmos.com  
Mas información en fricosmos.com

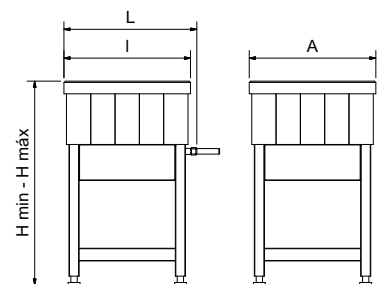

L	I	A	H min	H max	Kg	033004	€
525	500	500	805	1005	45,00	033004	1.650,00

## Repuesto de mazas

Spare wooden blocks  
Billots de rechange



Abedul  
Birch  
Bouleau



Encina  
Holm oak  
Chêne vert

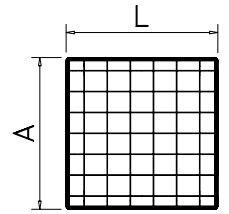

			Madera de abedul Birch wood Bois bouleau			Madera de encina Holm oak wood Bois de chêne vert		
L	A	H	Kg	Barcode	€	Kg	Barcode	€
400	400	250	30	433002	<b>240,00</b>	40	433202	<b>389,00</b>
450	450	250	38	433004	<b>259,00</b>	50	433204	<b>480,00</b>
500	500	250	47	433006	<b>321,00</b>	62	433206	<b>565,00</b>
600	400	250	45	433008	<b>306,00</b>	60	433208	<b>565,00</b>
700	500	250	66	433010	<b>438,00</b>	87	433210	<b>786,00</b>
1.000	500	250	94	433012	<b>680,00</b>	125	433212	<b>1.117,00</b>

## Repuesto de mazas para acoplar fibra superpuesta

Spare wooden block to attach fibre on top  
Billots en bois de rechange pour accoupler fibre superposée

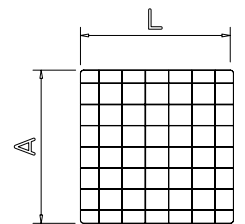

### Características:

Estos repuestos de maza están preparados para llevar acoplada en su parte superior una fibra de polietileno.

### Characteristics:

These spare wooden blocks are intended only to fix a polyethylene fibre on top.

### Caractéristiques:







Ces blocs de rechange été désinnés seulement pour tenir superpose dans la part supérieure une fiber de polyéthylène.

			Madera de abedul Birch wood Bois bouleau		
L	A	H	Kg	Barcode	€
380	380	200	22	433014	<b>174,00</b>
430	430	200	28	433016	<b>194,00</b>
480	480	200	34	433018	<b>234,00</b>
580	380	200	33	433020	<b>234,00</b>
680	480	200	49	433022	<b>331,00</b>
980	480	200	71	433024	<b>453,00</b>

## Repuestos y accesorios para tajos

Spare parts for chopping blocks

Pièces de rechange pour billots de découpe

		Descripción Description Description				
					Gr	€
	<b>Portacuchillos para adosar con envolverte</b> Mounted knife holder with wrapping Porte-couteaux pour adosser avec enveloppant	375	040602	<b>86,00</b>		
	<b>Portacuchillos para adosar en varilla</b> Rod mounted knife holders Porte-couteaux pour adosser sur tringle	270	040802	<b>43,00</b>		
		300	040804	<b>46,00</b>		
		330	040806	<b>48,00</b>		
	<b>Portacuchillos para adosar en chapa</b> Plated knife holders for mounting Porte-couteaux plaqué pour adosser	600	041002	<b>24,00</b>		
		730	041004	<b>28,00</b>		
	<b>Acoplar portacuchillos</b> Assembly knife holder Assembler porte-couteaux			<b>28,00</b>		
	<b>Tolva evacuación de desperdicios para adosar a tajos de troceo</b> Waste receptacle for scraps to fix to chopping blocks Trémie d'évacuation des déchets pour adosser à billots	2.300	082402	<b>66,00</b>		
	<b>Jamonero para adosar a tajo con madera</b> Ham holder to fix to wooden chopping block Porte-jambon pour adosser à un billot en bois	2.770	041820	<b>167,00</b>		
	<b>Taco regulable</b> Adjustable blocks Taquets réglables	45	409851	<b>1,50</b>		

**Fibras estándar**  
Standard cutting boards  
Plaques standard



Consulten si desean fibras en otros colores.  
Please ask if you would like fibres in other colours.  
Consultez-nous si vous voulez plaques en d'autres couleurs.

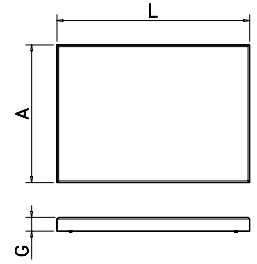

		Espesor Thick Grosueur		G = 20 mm		G = 30 mm		G = 50 mm		G = 70 mm		G = 100 mm			
L	A			€			€			€			€		
300	200		431214	<b>15,00</b>		431252	<b>20,00</b>								
			431314			431352									
			431404			431410									
			431604			431610									
			431804			431810									
			431904			431910									
400	300		431218	<b>26,00</b>		431256	<b>37,00</b>								
			431318			431356									
			431406			431412									
			431606			431612									
			431806			431812									
			431906			431912									
400	400					431261	<b>46,00</b>		431276						
						431357			431364						
								431420	<b>77,00</b>		431420				
								431662			431662				
450	450								431820						
						431282	<b>97,00</b>		431282						
									431368						
500	300		431220	<b>32,00</b>		431258	<b>46,00</b>								
			431320			431358									
			431408			431414									
			431608			431614									
			431808			431814									
			431908			431914									
500	330		431228	<b>35,00</b>		431260	<b>50,00</b>								
			431328			431360									
500	400		431230	<b>39,00</b>		431262	<b>58,00</b>		431278	<b>96,00</b>					
			431330			431361									
500	500								431284			431289	<b>179,00</b>		
									431370			431388			
										431424	<b>109,00</b>			431290	<b>255,00</b>
										431666			431658	<b>179,00</b>	
600	400		431232	<b>49,00</b>		431264	<b>72,00</b>		431280	<b>118,00</b>					
			431332			431362			431366						
600	500		431236	<b>57,00</b>		431270	<b>86,00</b>								
			431336												
700	500								431286	<b>169,00</b>			431292	<b>349,00</b>	
									431372						
1.000	400					431266	<b>115,00</b>								
1.000	500								431288	<b>239,00</b>					
									431374						

**Fibras GN**  
GN polyethylene boards  
Plaques GN

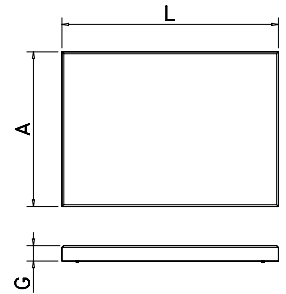
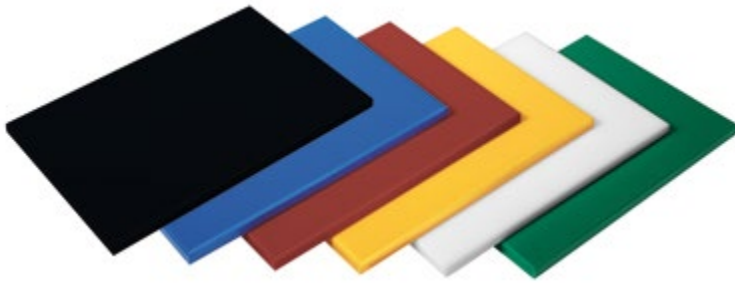

Modelo Model Model	L	A	Kg	€
G = 20 mm				
1/1	530	325	3,45	<b>33,00</b>
				434604
				434612
				434622
				434632
				434642
				434680
1/2	325	265	1,72	<b>17,00</b>
				434652
				434658
				434664
				434670
				434676
				434684
				434654
				434660
1/3	325	176	1,14	<b>11,00</b>
				434666
				434672
				434678
				434686
2/3	354	325	2,30	<b>22,00</b>
				434650
				434656
				434662
				434668
				434674
				434682

**Tabla de corte alta precisión**  
High precision cutting board  
Plaque de coupe de haute précision



No adecuada para troceo y cortes profundos.  
Not suitable for chopping and deep cuts.  
Non appropriée pour la découpe et coupes profondes.

**Características:**

Diseñadas para los mejores Chefs quienes exigen alta calidad y utilizan cuchillos de alta gama.  
Su suave superficie cuida el filo del cuchillo prolongando su vida.  
Superficie antideslizante permitiendo cortes más delicados y precisos.  
Varios colores. Certificados NSF, para evitar la contaminación cruzada.

**Characteristics:**

Intended for the finest Chefs, that use a high range of professional knives and demand the maximum cutting requirements.  
Smooth surface for the preservation of the edge of the knife to extend its life and effectiveness.  
Non-slip surface for and a smooth cutting with the highest accuracy.  
Several colors. NSF certificated to avoid cross-contamination.

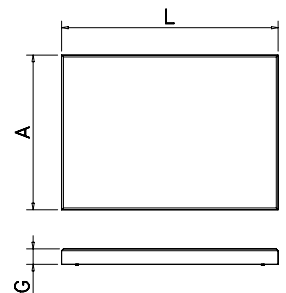

**Caractéristiques:**  
Plaque de coupe haute précision  
Conçues pour les meilleurs Chefs, avec grande exigence dans la coupe de haute qualité et l'usage de couteaux hauts de gamme.  
Sa surface douce conserve le fil du couteau en prolongeant son efficacité.  
Surface antidérapante permettant des coupes plus délicates et précises.  
Plusieurs couleurs. Certificats NSF pour éviter la contamination croisée.

L	A	G	Gr	€
500	250	8	900	434494 <b>40,00</b>
340	230	8	600	434496 <b>30,00</b>
500	250	8	900	434498 <b>40,00</b>

## Fibra redonda de corte de polietileno de alta densidad P500

Round high density P500 polyethylene cutting board

Plaque de découpe ronde de polyéthylène de haute densité P500

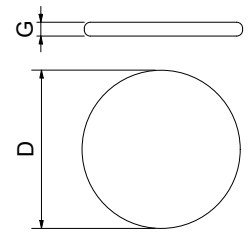

D	G		Kg	Barcode	€
500	50		9,8	431275 431392	<b>159,00</b>

## Fibras a medida

Bespoke cutting boards  
Plaques sur mesure



### Como calcular el precio de sus fibras a medida

How to calculate the price of your bespoke cutting boards  
Comment calculer le prix de vos plaques sur mesure ?



P.ej.: Una fibra roja de 0,525 m x 0,365 m en 30 mm de espesor, haríamos la siguiente operación:  
 $0,525 \times 0,365 = 0,1916 \text{ m}^2$

Por lo que su precio de venta al público se obtendría de la siguiente manera:  
 $0,1916 \text{ m}^2 \times 285,00 \text{ euros/metro cuadrado} = 54,61 \text{ Euros.}$



For example: for a red fibre of 0.525 mts. x 0.365 mts. and 30 mm. thick we would proceed in the following way

So that the public price should be obtained as follows:  
 $0.1916 \text{ m}^2 \times 285.00 \text{ €/m}^2 = 54,61\text{€.}$

Par exemple: pour une fibre rouge de 0.525 mts. x 0.365 mts. et 30 mm. d'épaisseur on procède de la façon suivante.

Tellement que le prix de vente au public serait obtenu comme suivre:  
 $0.1916 \text{ m}^2 \times 285.00 \text{ €/m}^2 = 54,61\text{€.}$



Se pueden instalar tacos antideslizantes en las fibras sin cargo alguno. Indíqueno a la hora de hacer el pedido.

Antisliding pegs can be installed without additional cost. Please, let us know when placing your order.

On peut installer chevilles antiglissantes dans les plaques sans coût additionnel. Indiquez-le dans la commande.

Grueso Thick Epaisseur mm.	€ m <sup>2</sup>	Barcode	Barcode	Barcode	Barcode	Barcode	Barcode
20	<b>189,00</b>	432006	432106	432406	432606	432806	432706
30	<b>285,00</b>	432010	432110	432410	432610	432810	432710
50	<b>475,00</b>	432014	432114	432414	432614	432814	432714

## Repuesto de fibras para mesas

Spare polyethylene boards for tables  
Plaques de rechange pour tables

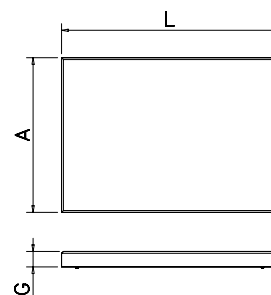

L	A	G	Kg	Barcode	€
1.000	500	20	10,00	431223 431323	<b>96,00</b>
1.500	500	20	15,00	431225 431325	<b>143,00</b>
2.000	500	20	20,00	431227 431327	<b>190,00</b>
1.000	600	20	12,00	431229 431329	<b>114,00</b>
1.500	600	20	18,10	431231 431331	<b>171,00</b>
2.000	600	20	24,00	431233 431333	<b>228,00</b>
1.000	700	20	14,00	431235 431335	<b>133,00</b>
1.500	700	20	21,00	431237 431337	<b>200,00</b>
2.000	700	20	28,00	431239 431339	<b>266,00</b>

L	A	G	Kg	Barcode	€
1.000	480	20	9,60	432030 432130	<b>92,00</b>
1.500	480	20	14,40	432032 432132	<b>137,00</b>
2.000	480	20	19,20	432034 432134	<b>183,00</b>
1.000	580	20	11,60	432036 432136	<b>111,00</b>
1.500	580	20	17,40	432038 432138	<b>166,00</b>
2.000	580	20	23,20	432040 432140	<b>222,00</b>
1.000	680	20	13,60	432042 432142	<b>130,00</b>
1.500	680	20	20,40	432044 432144	<b>194,00</b>
2.000	680	20	27,20	432046 432146	<b>259,00</b>

L	A	G	Kg	Barcode	€
540	480	20	5,20	431234 431654 431334	<b>74,00*</b>
545	500	20	5,00	431217 431653 431317	<b>76,00*</b>
700	500	20	7,00	431238 431656 431338	<b>90,00*</b>
1.000	500	30	10,00	431650	<b>145,00*</b>

● Con agujero de 150 mm de diámetro.  
With 150 mm diameter hole.  
Avec trou de 150 mm.

L	A	G	Kg	Barcode	€
760	500	20	7,60	431215 431655 431315	<b>76,00</b>
500	400	20	4,00	431652	<b>39,00</b>
500	400	40	8,00	431274	<b>58,00</b>
1.000	300	20	6,00	431222 431322	<b>57,00</b>
1.500	300	20	9,00	431224 431324	<b>86,00</b>
2.000	300	20	12,00	431226 431326	<b>114,00</b>
1.500	400	20	12,00	431293 431376	<b>115,00</b>
2.000	400	20	16,00	431294 431378	<b>152,00</b>
2.500	300	20	20,00	431295 431380	<b>145,00</b>
3.000	300	20	24,00	431296 431382	<b>257,00</b>



**Fibras por planchas**  
Polyethylene sheets  
Fibras par plaque

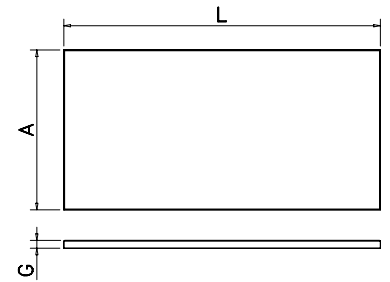
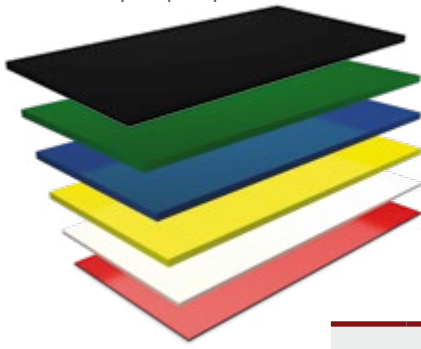

L	A	G	€/ud.	Kg	Barcode 1	Barcode 2	Barcode 3	Barcode 4	Barcode 5	Barcode 6
2.020	1.020	20	<b>391,00</b>	41,2	431028	431128	433406	433606	433806	433706
2.020	1.020	30	<b>587,00</b>	61,9	431032	431132	433410	433610	433810	433710
2.020	1.020	40	<b>782,00</b>	82,4	431034	431134				
2.020	1.020	50	<b>987,00</b>	103,0	431036	431136	433414	433614	433814	433714

**Tajo-expositor para mostrador de pescadería**  
Polyethylene cutting board-display for fish counter  
Plaque de découpe-exposant en polyéthylène pour étal à poisson

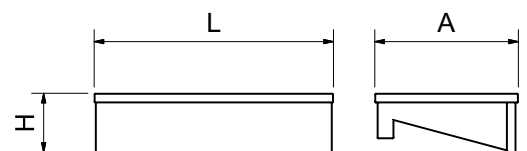
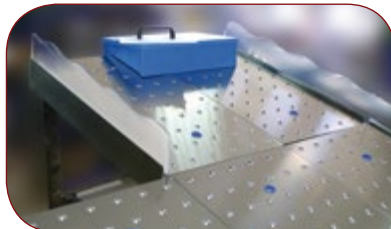

L	A	H	Kg	Barcode	€
500	300	125	4,70	074460	<b>190,00</b>

**Tope para fibras**  
Brackets for polyethylene boards  
Butée pour plaques

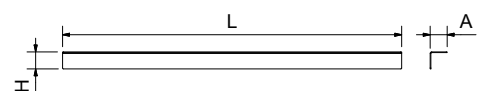

Detalle de fijación a fibra.  
Fibre fixing detail.  
Détail de fixation.

L	A	H	Gr	Barcode	€
395	20	20	102	035002	<b>5,00</b>

### Cepillo rascador de fibras

Plane for fibres  
Rabot pour plaques



434452



21,00



2



Juego de cuchillas de repuesto para cepillo rascador.  
Spare scraper blades set for plane  
Jeu de lames de réchange pour rabot à racloir

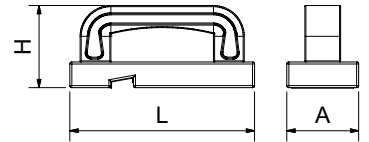
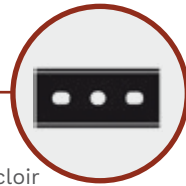

L	A	H	Gr	Barcode	€
180	70	80	500	434450	<b>77,00</b>

### Cepillo cerdas inox

Brush with stainless steel bristles  
Brosse d'acier inoxydable

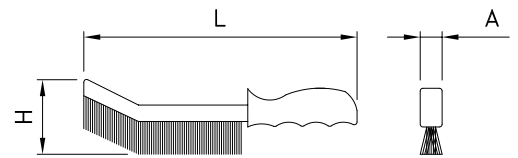

L	A	H	Gr	Barcode	€
165	50	100	400	434474	<b>15,00</b>

### Escurridor para fibras de corte

Chopping board rack  
Egouttoir pour planches à découper



Ejemplos de utilización de forma mural o sobremesa.  
Examples of using a wall-mounted or standing.  
Exemples d'utilisation sur table ou accroché au mur.

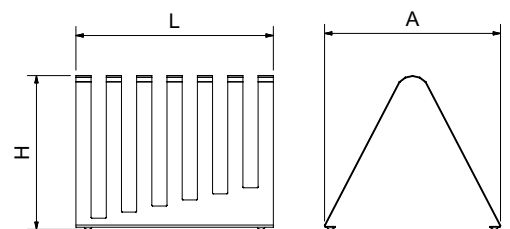

L	A	H	Kg	Barcode	€
325	290	250	1,55	035004	<b>65,00</b>

## Estropajo para tablas de corte

Cutting board scraper

Éponges pour plaque de coupe



### Características:

Tecnología patentada de excepcional capacidad de raspado. Borra las manchas duras, el amarilleo por el uso, marcas y mohos de la superficie de las tablas de corte. Además permite suavizar la superficie después del raspado.

Este producto está diseñado para un mantenimiento diario de sus tablas de corte, de suma importancia para mantenerlas en óptimas condiciones de higiene.

### Characteristics:

Patented technology with exceptional scraping capability. It is specially recommended to remove the most stubborn dirt, the yellowing by use or any mark on the surface of cutting boards.

This product is intended for daily maintenance of your cutting boards, which is essential to keep them in optimal hygienic conditions.

### Caractéristiques:

Une technologie patentée de capacité exceptionnelle de grattage. Elle efface les taches dures, le jaunissement par l'usage, les marques et les moisissures de la surface des plaques de coupe. De plus elle permet d'adoucir la surface après le grattage.

Ce produit est conçu pour une maintenance quotidienne de vos plaques de coupe, d'importance suprême pour les maintenir dans des conditions parfaites d'hygiène.

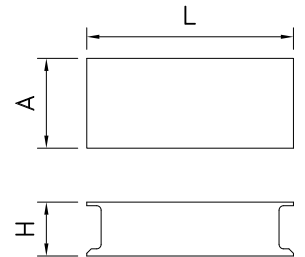

L	A	H	Gr	Barcode	€
115	50	30	18	434006	9,00

## Calzo elevador para fibra

Levelling blocks for polyethylene boards

Cale pour plaque de découpe

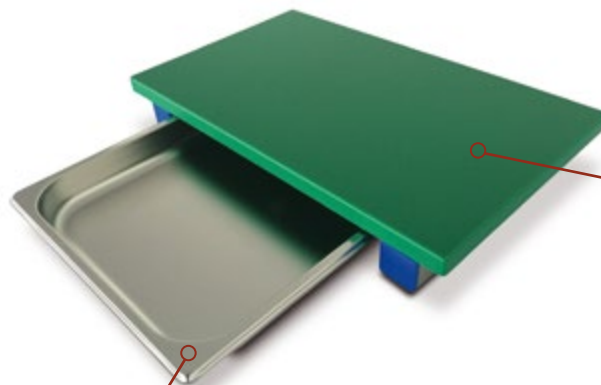
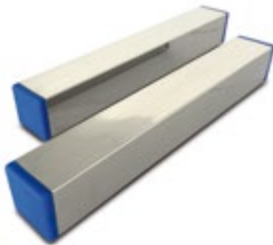

431806 26,00 75

Fibras estándar 400x300x20  
Standard cutting board 400x300x20  
Plaques standard 400x300x20



435

Cubetas Gastronorm lisas.  
Non-perforated Gastronorm  
containers.  
Bacs Gastronorm lisses.

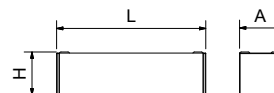

L	A	H	Gr	Kg	Barcode	€
285	40	45	2	0,75	035010	25,00
285	80	85	2	2,90	035012	50,00



El precio es por pareja.  
The pair is included in the price.  
Le paire est inclus dans de prix.

## Útil de centrado para corte de fruta

Fruit preparation centering tool

Accessoire de préparation pour centrage de fruit



### Características:

Construido en fibra de polietileno, su diseño permite cortar con seguridad sandías, melones, piñas, etc.

### Characteristics:

Made from polyethylene. Designed for cutting safely melons, pineapples, watermelons, etc.

### Caractéristiques:

Fabriqu  en poly thyl ne. Con u pour couper en toute s curit  les melons, ananas, p t ques, etc.

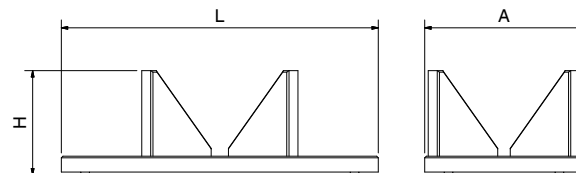

L	A	H	Kg	Barcode	€
400	200	132	2,10	042202	<b>125,00</b>

## Fibra de colores intercambiables

Fibre with interchangeable colour set

Plaque de couleur interchangeable



Colores incluidos: Marr n, blanco, azul, verde, amarillo y rojo.

Colors included: Brown, white, blue, green, yellow and red.

Couleurs inclus: Marron, blanc, bleu, vert, jaune et rouge.

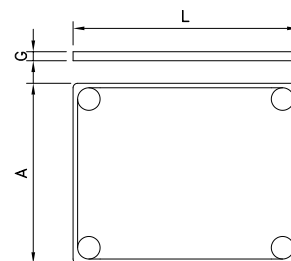

L	A	G	Kg	Barcode	€
500	400	20	7,00	434470	<b>67,00</b>

## Pack de 6 colores de repuesto

Spare pack of 6 colours

Set de 6 couleurs de rechange

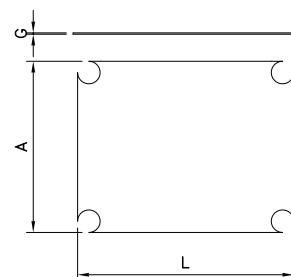

L	A	G	Kg	Barcode	€
500	400	3	3,00	434468	<b>37,00</b>

**Tabla de corte/pala de fibra**  
Cutting board/fiber shovel  
Plaque à découper/pelle en fibre



Fabricada en polietileno.  
Fácil limpieza (lavavajillas).

Made of polyethylene.  
Easy to clean (dishwasher).

Fabriquée en polyéthylène.  
Nettoyage facile (lave-vaisselle).

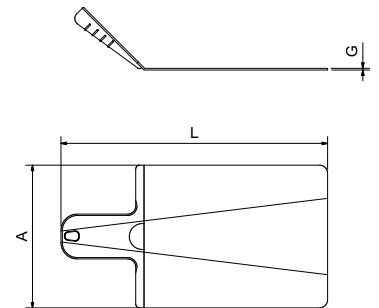

L	A	G		Kg		€
380	210	15		0,90	434480	<b>23,50</b>
480	270	15		1,50	434482	<b>23,50</b>

**Fibra para corte de pan**  
Bread cutting board  
Planche à découper le pain

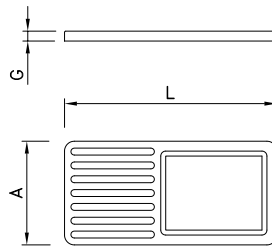

L	A	G		Kg		€
---	---	---	--	----	--	---

430 210 20 1,80 434446 **47,00**

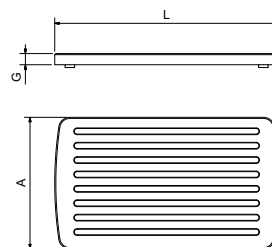

400 240 20 1,60 434444 **27,00**

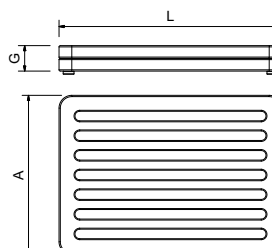

350 250 40 3,00 434448 **62,00**

430 330 40 5,00 434449 **80,00**

**Rodillo**  
Rolling pin  
Rouleau



L	D	Kg	Barcode	€
600	60	1,2	434440	<b>52,00</b>

**Mazo de picar**  
Mincing hammer  
Marteau à viande

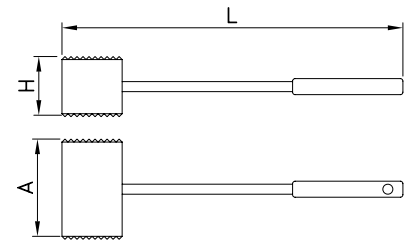

L	A	H	Kg	Barcode	€
340	100	60	1,20	434454	<b>54,00</b>

**Remo**  
Polyethylene mixing paddle  
Spatule à mélanger en polyéthylène

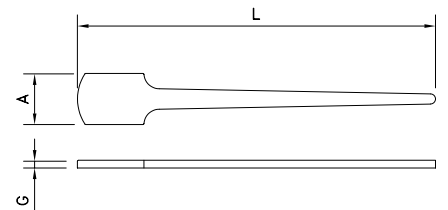

L	A	G	Gr	Barcode	€
450	105	15	200	434402	<b>18,00</b>
700	105	20	400	434404	<b>30,00</b>
995	100	25	600	434406	<b>54,00</b>

**Pala de acero inoxidable y polietileno**  
Stainless steel and polyethylene mixing paddle  
Spatule à mélanger en acier inoxydable et polyéthylène

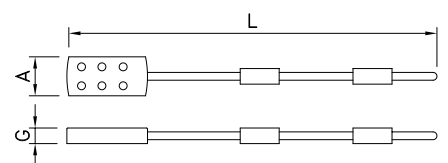

L	A	G	Kg	Barcode	€
1.000	100	25	1,00	434456	<b>79,00</b>
1.348	110	28	1,32	434458	<b>92,00</b>

### Útil para picadora

Tool for mincer  
Outil pour hachoir

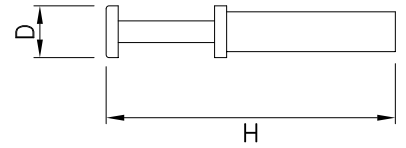

D	H	Gr	Barcode	€
43	240	350	434462	<b>39,00</b>
55	310	600	434464	<b>44,00</b>



### Mazo para chino

Tool for strainer  
Outil pour chinois étamine

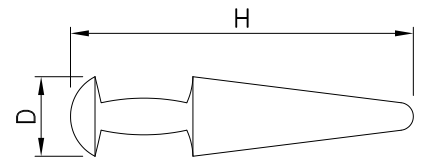

D	H	Gr	Barcode	€
65	280	400	434460	<b>55,00</b>

### Mortero

Mortar  
Mortier

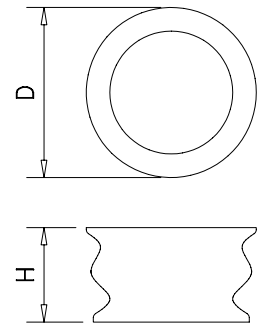

D	H	Kg	Barcode	€
180	100	1,4	434442	<b>140,00</b>

### Conjunto aros de emplatar

Ring mold set  
Set de moules

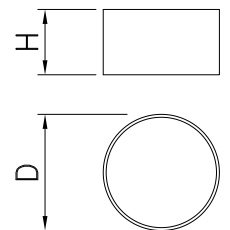

D	H	Gr	Barcode	€
60	45	150	434472	<b>13,00</b>
80	45	150		

## Triángulo

Triangle  
Triangle

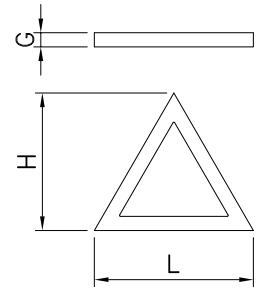

L	H	G	Gr	Barcode	€
435	380	20	500	434476	<b>49,00</b>

## Enrollador de maki higiénico

Sushi rolling mat, hygienic  
Enrouleur de maki hygiénique



Los mejores enrolladores super-higiénicos de makis con gran capacidad antiadherente del arroz. Un enrollador revolucionario que no hace uso de las tradicionales varitas de bambú ni del algodón para su cosido, sino de plásticos y monofilamentos avanzados. No sólo son higiénicos, sino también fáciles de rodar como un enrollador tradicional.

Principales ventajas:

- Apto para lavavajillas.
- No genera astillas o moho negro, como los bambúes convencionales.
- Los monofilamentos del cosido repelen la contaminación.
- Menor probabilidad de que el arroz se adhiera a sus superficies en relieve.
- Rápido secado para poder ser utilizado después del lavado.
- Tan fácil de rodar como los enrolladores convencionales de bambú.

Les meilleurs enrouleurs super-hygiéniques de makis avec une grande capacité antiadhésive du riz. Un enrouleur révolutionnaire qui n'utilise pas les traditionnelles baguettes de bambou ni du coton pour sa couture, sinon des plastiques et des monofilaments avancés. Non seulement ils sont hygiéniques, mais aussi faciles de rouler comme un enrouleur traditionnel.

Avantages principaux :

- Aussi facile de rouler que les conventionnels en bambou.
- Ne génère pas d'éclats ou de moisissure noire, comme les bambous conventionnels.
- Les monofilaments de couture repoussent la contamination.
- Une probabilité moindre que le riz s'adhère à ses surfaces en relief.
- Apte pour le lave-vaisselles.
- Sèche rapidement pour pouvoir être utilisé après le lavage.

The best makisu ever that are super hygienic and less likely to stick to rice.

A revolutionary makisu that makes use of neither the traditional bamboo nor cotton strings but advanced plastic and monofilaments. They are not only hygienic but also easy to roll as a makisu.

Its main advantages:

- Dishwasher safe, bleach safe.
- Does not generate splinters or black mold, like the conventional bamboo ones always does.
- Monofilaments that deter contamination are used for the binding strings.
- Rice less likely to stick to its embossed surfaces.
- Easy to dry so that can be used soon after washing.
- As easy to roll as conventional bamboo ones.

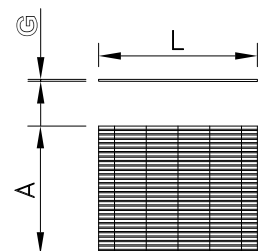

L	A	G	Gr	Barcode	€
250	165	3	110	434486	<b>30,00</b>
250	240	3	160	434488	<b>35,00</b>
250	305	3	200	434490	<b>45,00</b>





# CUCHILLERIA

PROFESSIONAL KNIVES  
COUTELLERIE PROFESSIONNELLE

## NOVEDADES

NEWS  
NOUVEAUTÉS



94

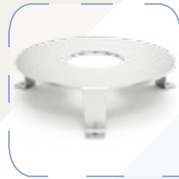

95



97



97



97



98



98



98



104



108



114

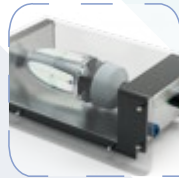

114



115



116



116



116



116



116



121



123



123



123



123



130



134



# CUCHILLERIA

## PROFESSIONAL KNIVES

### COUPELLERIE PROFESSIONNELLE

#### NOVEDADES

NEWS  
NOUVEAUTÉS

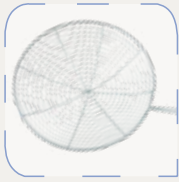

140



141



144



146



146

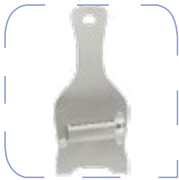

148



149



150



150



152

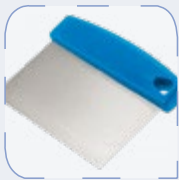

154



154



155



157



160



164



166

### LEYENDA

SYMBOLS / SYMBOLES

STD

Estándar  
Standard  
Standart



Forjado  
Forged  
Forgé



Reforzado  
Reinforced  
Renforcé



Mango remachado  
Riveted handle  
Manche riveté



Mango inyectado  
Injected handle  
Manche injecté





## Cuchillería profesional para Carniceros

Professional cutlery for Butchers  
Coutellerie professionnelle pour Bouchers

**Fileteros**  
Filet knives  
Couperet-steak

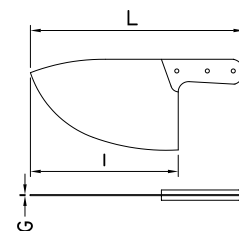

	L	I	H	G	Tipo Type	Gr	Barcode	€
	365	250	160	1,4	STD ↑	545	442202	<b>38,50</b>
	410	290	185	1,4	STD ↑	610	442206	<b>68,50</b>
	365	240	115	1,3	STD ↑	420	442208	<b>51,00</b>
	370	260	135	1,3	STD ↑	430	442212	<b>55,00</b>
	400	270	140	1,3	STD ↑	440	442214	<b>60,00</b>
	220	120	1,5	STD ↑	420	442200	<b>33,50</b>	
	250	140	1,5	STD ↑	580	442201	<b>36,00</b>	

**Chuleteros**  
Chop knives  
Couperet cotelettes

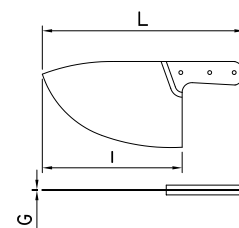

	L	I	H	G	Tipo Type	Gr	Barcode	€
	365	240	115	2,5	STD ↑	610	442408	<b>56,00</b>
	380	260	125	2,5	STD ↑	630	442410	<b>59,00</b>
	365	250	130	2,5	STD ↑	705	442412	<b>62,00</b>
	370	260	140	2,5	STD ↑	720	442414	<b>65,00</b>

**Esquinar**  
 Cornering knife  
 Couteau pour coins

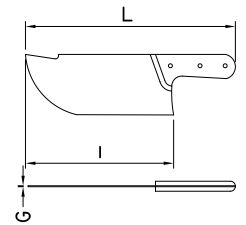

L	I	H	G	Tipo Type	Gr	Barcode	€
365	235	110	3,2	↑	845	442602	<b>66,00</b>
365	255	115	3,0	↑	890	442604	<b>78,00</b>
365	275	135	3,0	↑	990	442608	<b>89,00</b>



340	210	110	3,0	STD ↑	745	442802	<b>56,00</b>
345	220	120	3,5	STD ↑	795	442804	<b>62,00</b>
360	230	125	3,5	STD ↑	885	442806	<b>69,00</b>
380	250	140	3,5	STD ↑	1.035	442808	<b>70,50</b>
400	270	150	3,5	STD ↑	1.110	442810	<b>77,00</b>
405	280	160	3,5	STD ↑	1.270	442812	<b>91,00</b>

**Cuchillo todos usos**  
 Multipurpose Knife  
 Couteau tous usages

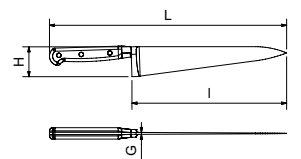

				Uso general General use Usage generale	Aves Chickens Volailles	Pescados Fish Poissons	Frutas y verduras Fruits & Vegetables Fruits et légumes	Carnes Meat Viandes			
L	I	H	G	Tipo Type	Gr	€	Barcode	Barcode	Barcode	Barcode	Barcode
310	175	35	2,6		135	<b>12,50</b>	444002	444074	444020	444056	444038
335	205	60	2,6		160	<b>17,00</b>	444004	444076	444022	444058	444040
355	220	40	2,6	STD ↑	190	<b>19,50</b>	444006	444078	444024	444060	444042
380	250	50	2,6		210	<b>20,50</b>	444008	444080	444026	444062	444044
430	305	50	2,6		275	<b>24,00</b>	444010	444082	444028	444064	444046
485	350	55	2,6		330	<b>31,00</b>	444012	444084	444030	444066	444048

**Cuchillo francés inyectado Adherent+**  
 French knife with injected handle Adherent+  
 Couteau français injecté Adherent+

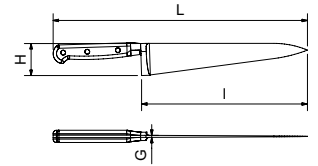

L	I	H	G	Tipo Type Type	Gr	Barcode	€
310	195	48	3	STD	160	444090	<b>17,00</b>

**Cuchilla de golpe**  
 Blow knife  
 Couperet à frapper

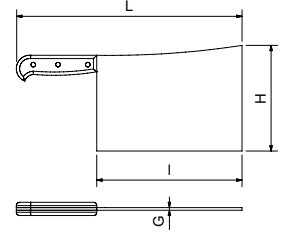

L	I	H	G	Tipo Type Type	Gr	Barcode	€
360	230	165	3,37	†	1.175	442002	<b>93,00</b>
380	255	185	3,37	†	1.350	442004	<b>114,00</b>
390	270	215	4,00	†	1.795	442006	<b>115,00</b>



305	195	160	4,5	STD	1.200	442010	<b>140,00</b>
330	220	170	4,5	STD	1.485	442012	<b>150,00</b>
350	240	170	4,5	STD	1.665	442014	<b>189,00</b>
360	245	190	4,5	STD	1.850	442016	<b>192,00</b>



330	210	180	3,5	†	1.045	442018	<b>78,00</b>
340	215	190	3,5	†	1.180	442020	<b>81,00</b>
345	220	200	3,5	†	1.250	442022	<b>88,00</b>
355	225	210	3,5	†	1.355	442024	<b>94,00</b>
370	240	220	4,0	†	1.570	442026	<b>104,00</b>
380	250	230	3,5	†	1.685	442028	<b>94,00</b>



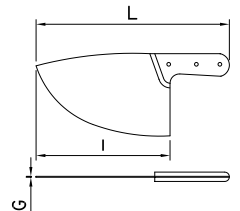

**Deshuesar Carne**  
 Boning meat knife  
 Désosseur

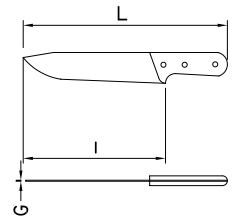

L	I	H	G	Tipo Type Type	Gr	Barcode	€
310	195	115	2,50	†	580	443404	<b>50,00</b>
320	200	120	2,70	†	635	443406	<b>55,00</b>
330	215	130	2,70	†	675	443408	<b>54,00</b>
355	270	125	2,70	†	715	443410	<b>58,00</b>

**Desollar**  
Skinning knife  
Ecorcheur



	L	I	H	G	Tipo Type	Gr	Barcode	€
	285	210	90	1,5	STD ↑	250	443604	<b>23,00</b>
	305	220	105	1,5	STD ↑	260	443606	<b>24,50</b>
	280	170	55	2	STD ↑	175	443802	<b>18,50</b>
	320	200	75	2	STD ↑	260	443806	<b>25,50</b>
	340	210	75	3	STD ↑	255	443808	<b>27,00</b>
	355	125	24	2,24	STD ↑	95	443002	<b>18,50</b>
	275	150	30	2,80	STD ↑	115	443004	<b>19,00</b>
	310	175	35	2,50	STD ↑	135	443006	<b>20,00</b>
	290	165	65	2	STD ↑	175	443810	<b>16,50</b>

**Pelar patas**  
Leg peeling knife  
Couperet d'office

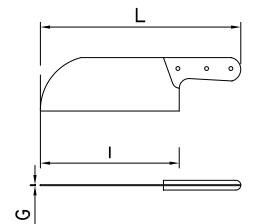

L	I	H	G	Tipo Type	Gr	Barcode	€
210	125	55	1,7	STD ↑	145	444202	<b>13,00</b>

**Pollero**  
Poultry knife  
Couteau à poulets

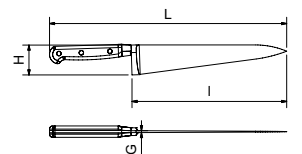

L	I	H	G	Tipo Type	Gr	Barcode	€
440	315	90	3,3	↑	745	447002	<b>56,50</b>
465	340	90	3,3	↑	805	447004	<b>65,00</b>

**Puntilla**  
Dagger  
Poignard

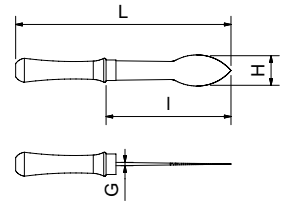

L	I	H	G	Gr	Barcode	€
260	140	33	4,5	185	444402	<b>39,00</b>

**Serrucho acero inoxidable**  
Stainless steel saw  
Scie en acier inoxydable

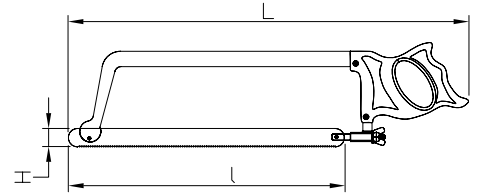

L	I	H	Gr	Barcode	€
565	400	165-20	835	447602	<b>63,00</b>
625	450	165-20	900	447604	<b>65,00</b>
725	550	165-20	1.050	447612	<b>70,00</b>

**Repuestos para serruchos**  
Spare parts for saws  
Pièces de rechange pour scie à main



			Gr	Barcode	€
↔	420	35	447606	<b>12,50</b>	
<b>Hoja de repuesto inox.</b> Spare inox blade Lame inox de rechange	470	40	447608	<b>13,00</b>	
	570	50	447610	<b>13,50</b>	
<b>Mango de repuesto para serrucho</b> Spare handle for saw Manche de rechange pour scie à main	210	200	447630	<b>16,00</b>	
<b>Tensor inox de repuesto</b> Spare inox strut Tendeur inox de rechange	50	25	447620	<b>16,00</b>	

**Aplasta hamburguesas circular**  
Rounded burger press  
Press à hamburger ronde

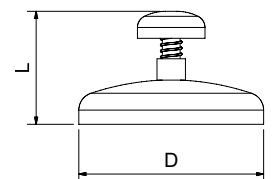

L	D	Gr	Barcode	€
70	104	250	041880	<b>75,00</b>

**Aplasta hamburguesas higiénico doble**  
 Hygienic hamburger press, double  
 Presse hamburger hygiénique double



Novedad  
 NEW  
 NOVEMBRE

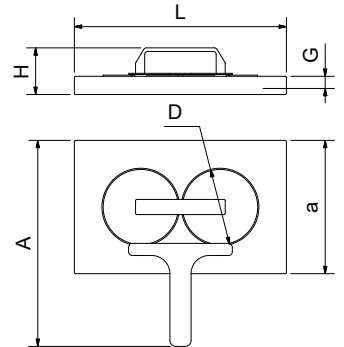

L	A	H	a	D	G	Kg	Barcode	€
325	315	80	195	100	20	2,0	041882	<b>121,00</b>
350	340	80	220	128	20	2,5	041884	<b>146,00</b>

**Aplasta hamburguesas de molde ovalado**  
 Oval mold burger press  
 Presse à hamburger moule ovale



Tamaño de la hamburguesa: 110x80 mm.  
 Burger size: 110x80 mm.  
 Taille burger: 110x80 mm.

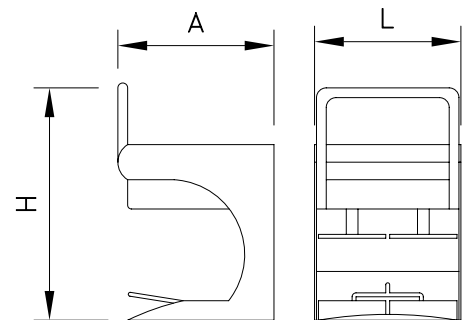

L	A	H	Kg	Barcode	€
●●	210	230	260	3,40	441850 <b>332,00</b>
●●●●	410	230	260	14,00	441852 <b>370,00</b>



## Aplasta hamburguesas de molde redondo

Round mold burger press  
Press à hamburger moule rond



Ø  
130

Ø  
100

Ø  
65

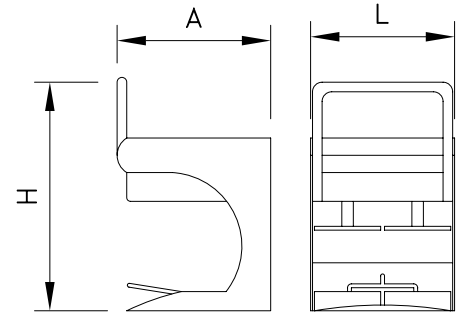

	L	A	H	Ø	Kg	Barcode	€
● ●	210	250	260	65	2,00	441846	<b>343,00</b>
● ● ● ●	410	250	260	65	3,00	441848	<b>400,00</b>
● ●	245	250	145	100	2,90	441854	<b>314,00</b>
● ●	410	250	260	130	6,00	441856	<b>393,00</b>

## Repuestos para aplasta hamburguesas

Spare parts for burger presses  
Pièces de rechange pour press à hamburger



	Gr	Barcode	€
Muelle elevación de palanca Spare lifting spring for lever Lame inox de rechange	9,00	441860	<b>15,00</b>
Pareja de muelles Springs Ressort gauches	26,00	441862	<b>29,00</b>

## Protector para picadora de carne

Meat grinder protection  
Protecteur de hachoir à viande

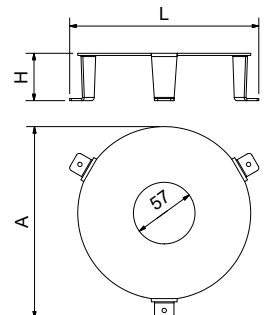

**N**ovedad  
NEW  
Innovation

L	A	H	Gr	Barcode	€
175	177	44	340	042210	<b>26,00</b>



## Cuchillería profesional para charcuteros

Professional cutlery for pork butchers  
Coutellerie professionnelle pour charcutiers

**Fiambre**  
Sausage knife  
Charcuterie

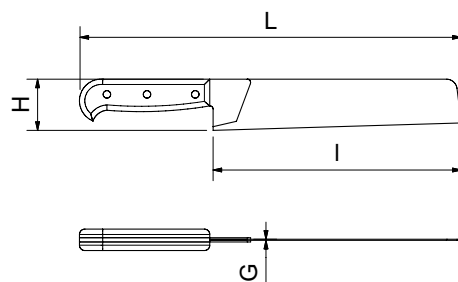

L	I	H	G	Tipo Type	Gr	Barcode	€
375	250	50	2,0	STD ↑	310	444806	<b>22,50</b>
425	300	60	2,5	STD ↑	405	444808	<b>33,50</b>
450	330	65	2,5	STD ↑	410	444810	<b>32,00</b>
475	350	65	2,5	STD ↑	475	444812	<b>41,00</b>

**Fiambre dos mangos**  
Double handle sausage knife  
Charcuterie deux manches

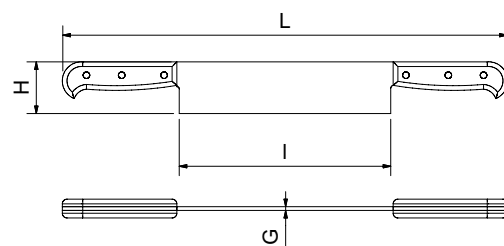

L	I	H	G	Tipo Type	Gr	Barcode	€
500	260	50	2,6	STD ↑	505	445002	<b>31,50</b>
570	305	60	2,7	STD ↑	560	445004	<b>32,50</b>
615	355	57	2,8	STD ↑	645	445006	<b>46,00</b>

**Queso**  
 Cheese knife  
 Couteau à fromage

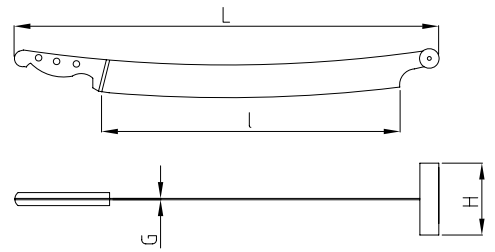

L	I	H	G	Tipo Type	Gr	Barcode	€
670	445	110	2,6	STD	†	535 448202	59,00

**Cuchillo especial queso tierno**  
 Soft cheese knife  
 Couteau spécial fromage à pâte molle

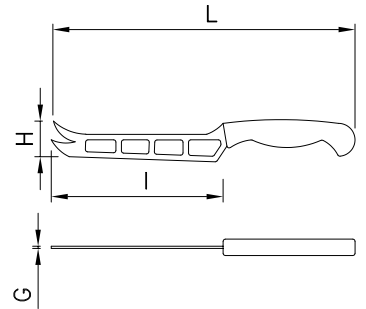

L	I	H	G	Tipo Type	Gr	Barcode	€
260	140	35	1,6	STD	†	41 448212	32,00

**Cuchillo especial queso lama perforada**  
 Special cheese knife with perforated blade  
 Couteau à fromage spécial avec lame perforée

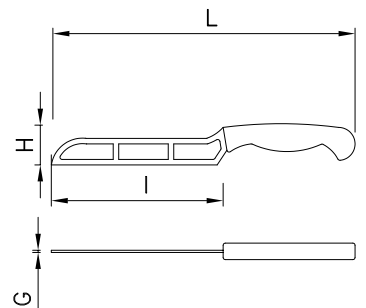

L	I	H	G	Tipo Type	Gr	Barcode	€
340	220	34	1,7	STD	†	100 448214	34,00

**Cuchillo especial queso Pavia**  
 Knife for Piave cheese  
 Couteau à fromage spécial pour Pavia ou Parmesan

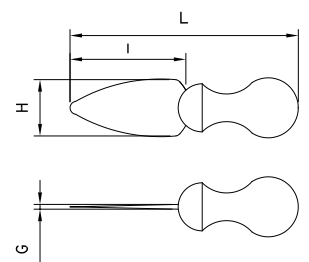

L	I	H	G	Tipo Type	Gr	Barcode	€
190	100	45	3,7	STD	†	135 448204	20,50

**Cuchillo especial queso Parmesano**  
 Knife for Parma cheese  
 Couteau spécial Parmesan

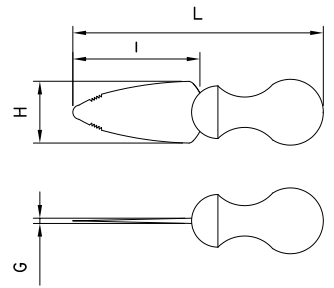

L	I	H	G	Tipo Type	Gr	Barcode	€
230	150	43	3,5	STO	145	448216	<b>27,50</b>

**Cuchillo especial queso Feta**  
 Knife for Feta cheese  
 Couteau à fromage spécial Feta

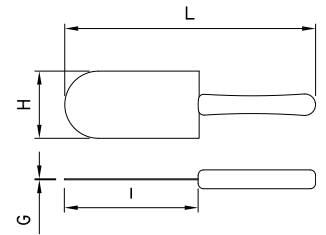

L	I	H	G	Tipo Type	Gr	Barcode	€
280	150	75	1,5	STO	170	448208	<b>29,00</b>

**Cuchillo especial queso Emmental**  
 Knife for Emmental cheese  
 Couteau à fromage spécial Emmental

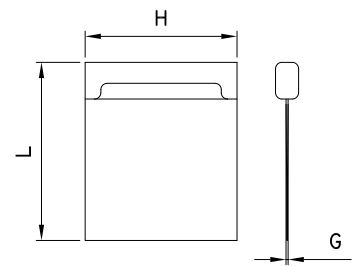

L	H	G	Tipo Type	Gr	Barcode	€
230	170	2,0	STO	515	448206	<b>88,00</b>

**Lira para cortar queso**  
 Cheese slicer  
 Lyre pour couper le fromage

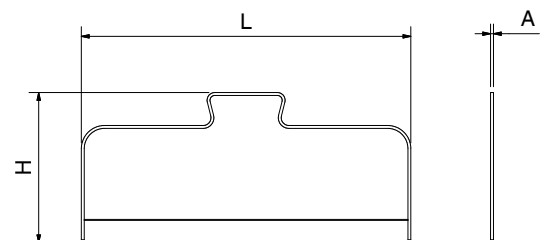

L	A	H	Gr	Barcode	€
220	10	280	106	448210	<b>8,00</b>

## Pala inox para loncheado de embutidos

Sausage slicing inox-shovel  
Pelle inoxydable pour trancher la charcuterie



Mades entirely of stainless steel, this sausages slicing shovel allows you to bag and / or vacuum pack the sausage easily and hygienically.

It is ideal to place the slices in the desired way for later packaging without discoloration. It saves time and is more hygienic since it requires less food handling.

Thanks to the fact that it is made of stainless steel, its cleaning and disinfection is much simpler since no remains accumulate in possible cracks or scratches, in contrast to the ones in plastic or in polyethylene. In addition, its durability is significantly longer.

Entièrement fabriquées en acier inoxydable, ces pelles pour trancher la charcuterie vous permet d'envelopper et / ou d'emballer sous vide la charcuterie facilement et de manière hygiénique.

Elle est idéale pour placer les tranches de la manière souhaitée pour un emballage ultérieur sans désordre. Il fait gagner du temps et est plus hygiénique car elle nécessite moins de manipulation des aliments.

Comme elle est fabriquée en acier inoxydable, son nettoyage et sa désinfection sont beaucoup plus simples car aucun résidu ne s'accumule dans d'éventuelles fissures ou rayures, contrairement au plastique ou au polyéthylène. De plus, sa durabilité est nettement plus longue.

Fabricadas completamente en acero inoxidable, estas palas para loncheado de embutidos permite embolsar y/o envasar al vacío el embutido de manera fácil e higiénica.

Es ideal para colocar las lonchas de la forma deseada para posteriormente su envasado sin que se descoloque. Ahorra tiempo y es más higiénico ya que requiere menor manipulación del alimento.

Gracias a que están fabricadas en acero inox, su limpieza y desinfección es mucho más sencilla ya que no se acumulan restos en posibles grietas o arañazos, a diferencia del plástico o el polietileno. Además, su durabilidad es significativamente mayor.

AD

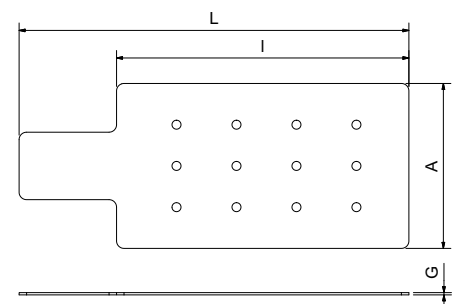

L	I	H	G	Gr	Barcode	€
260	195	110	1,5	288	041860	<b>15,00</b>
320	200	150	1,5	396	041862	<b>17,00</b>

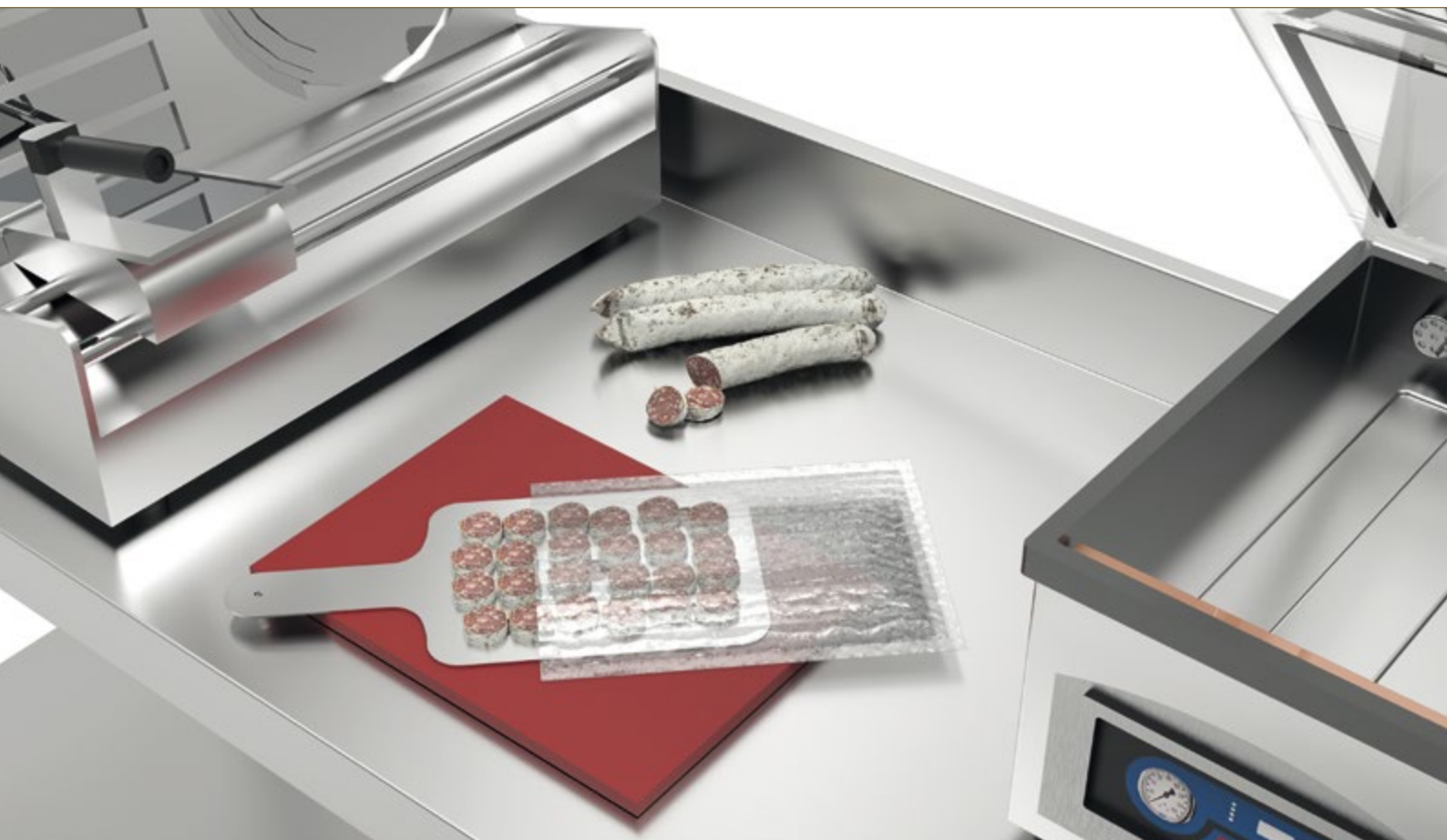



AD

## Mundo del jamón

World of ham  
Monde du jambon

Les presentamos el nuevo sistema RT de sujeción, con un solo punto de apoyo, diseñado para la presentación, corte y almacenamiento del jamón.

RT clamping system, with a single supporting point, designed for presentation, cutting and storage of ham.

Système de fixation RT, avec un seul point d'appui, conçu pour la présentation, la coupe et le stockage du jambon.



Con nuestros novedoso sistema de soporte RT podrá trasladar el jamón de la barra expositora al jamonero en un instante.

Fácil intercambio del jamón a cortar. El útil de acoplamiento RT que incorpora está diseñado para colocar instantáneamente el jamón en el jamonero.

With our innovative RT support system you can move the ham from the display bar to the ham holder instantly.

The ham is easily exchangeable. The built-in RT coupling tool is designed to instantaneously place the ham in the ham holder.

Avec notre nouveau système de support RT, vous pouvez déplacer le jambon de la barre d'exposition au support de jambon en un instant.

Facile échange de jambon à couper. L'outil de couplage RT intégré est conçu pour placer instantanément le jambon dans le porte-jambon.





**Profesional**, este sistema le ayudará a exponer mejor el jamón, colocándolo en la posición más adecuada en cada momento, favoreciendo la facilidad y efectividad del corte.

Professional, this system will help you to display the ham better. In addition, you will be able to slice it in the most appropriate position at each moment to slice it in an easy and effective way.

Professionnel, ce système vous aidera à mieux exposer le jambon, en le plaçant dans la position la plus appropriée à chaque moment, en favorisant la facilité et l'efficacité de la coupe.



**Higiénico**, al tener un solo punto de apoyo y quedar el jamón suspendido, las labores de limpieza se facilitan al máximo.

The ham is hold with one single supporting point, which results in an easy cleaning and better hygiene.

Hygiénique, n'ayant qu'un seul point d'appui et laissant le jambon suspendu, les tâches de nettoyage sont facilitées au maximum.



Con nuestros útiles de acoplamiento RT puede tener varios jamones expuestos y preparados para cortar en cualquier momento.

With our RT coupling tools you can have several hams displayed and ready to slice it at any time.

Avec nos outils de couplage RT, vous pouvez avoir plusieurs jambons exposés et prêts à couper à tout moment.

Este novedoso sistema permite:  
Rotación 360° en dos dimensiones [Modelos RT-2D]  
Rotación 360° en tres dimensiones [Modelo RT-3D]

This innovative system allows:  
360° rotation in two dimensions [Models RT-2D]  
360° rotation in three dimensions [Model RT-3D].

Ce système innovant permet:  
Rotation à 360° en deux dimensions [Modèles RT-2D]  
Rotation à 360° en trois dimensions [Modèle RT-3D]

AD



### Jamonero giratorio basculante RT-3D

Tilting rotating ham holder RT-3D  
Porte-jambon giratoire basculant RT-3D



Se puede atornillar o soldar a cualquier superficie.

To be screwed or welded on any surface.

Peut se visser ou souder à n'importe quelle surface.

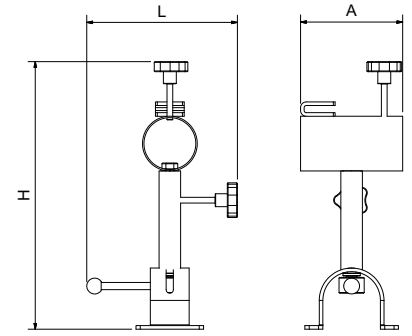

L	A	H	Kg	Barcode	€
210	140	370	1,8	041806	182,00

### Jamonero giratorio RT-2D

Rotating ham holder RT-2D  
Porte-jambon giratoire RT-2D



Se puede atornillar o soldar a cualquier superficie.

To be screwed or welded on any surface.

Peut se visser ou souder à n'importe quelle surface.

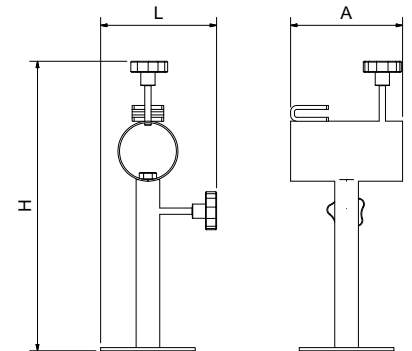

L	A	H	Kg	Barcode	€
150	140	370	1,4	041808	123,00

### Jamonero giratorio mural RT-2D

Wall-mounted rotating ham holder RT-2D  
Porte-jambon giratoire mural RT-2D

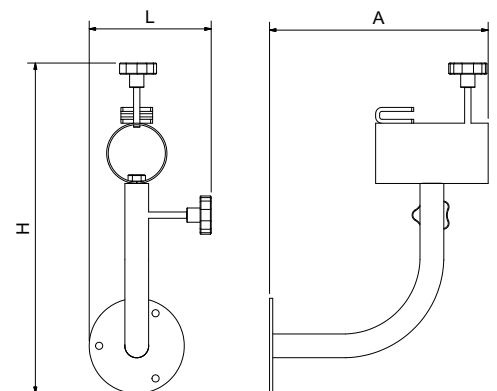

L	A	H	Kg	Barcode	€
155	275	415	1,8	041810	128,00



**Soporte jamón RT**  
Ham holder RT  
Support jambon RT

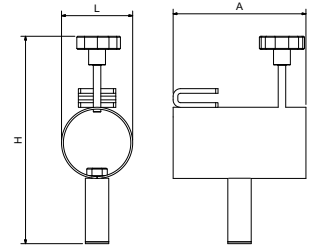

L	A	H	Gr	Barcode	€
75	140	220	800	041812	68,00

**Útil para sujeción de jamones**  
Ham holder tool  
Outil pour porter jambons

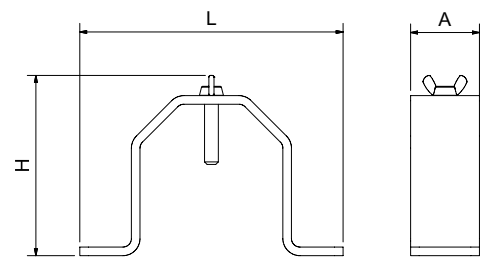

L	A	H	Gr	Barcode	€
153	40	105	400	024250	110,00

**Portajamones**  
Ham support  
Support jambons



**Características:**

Fabricado en una sola pieza, totalmente en acero inoxidable.  
Su diseño consigue que cualquier jamón se acople con facilidad quedando firmemente sujeto.  
Fácil limpieza. Al estar fabricado en acero inoxidable se puede introducir en máquinas de lavado y esterilización.  
Tacos antideslizantes.

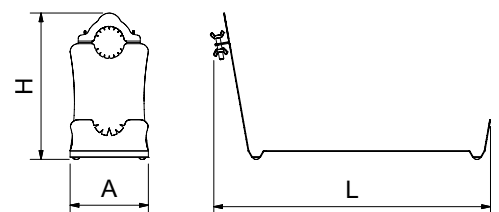

L	A	H	Kg	Barcode	€
510	270	144	2,7	041802	41,00

**Characteristics:**  
One piece construction in stainless steel.  
Its design allows an easy and firm fixing of any piece of ham.  
Easy to clean, as it is made in stainless steel it can be washed in any washing or sterilizing device.  
Anti-sliding plugs.

**Caractéristiques:**  
Construit d'une seule pièce en acier inoxydable.  
Son design permet accoupler facilement et solidement quelque jambon.  
Facile à nettoyer puisque c'est construit en acier inoxydable et il est possible de l'introduire dans quelque appareil à laver ou à désinfecter.  
Tampons anti-glissants.

## Jamonero para adosar a tajo con madera

Ham holder to fix to wooden chopping block  
Porte-jambon pour adosser à un billot en bois



### Características:

Fabricado en acero inoxidable AISI 304 este jamonero es especial para instalarlo en un tajo que contenga un bloque de madera.

Su diseño robusto y resistente, nos permite colocar el jamón en dos posiciones diferentes, una optimizada para el corte y otra para el deshuesado. Por lo que, si colocamos el jamón en el agujero superior, lo tendremos en la mejor posición para cortar y si lo colocamos en el agujero inferior, estará preparado para deshuesar.

Una de sus principales ventajas es que no ocupa espacio alguno en la superficie de trabajo, por lo que puede estar colocado todo el tiempo, estando en uso o no, sin suponer un estorbo.

Es fácil de instalar, ya que va atornillado en el bloque de madera.



### Characteristics:

Made of AISI 304 stainless steel, this ham holder is special for installation in a wooden chopping block.

Heavy duty and robust design. It also design allows us to place the ham in two different positions, one optimized for cutting and another for boning. So, if we put the ham in the upper hole, we will have it in the best position to cut and if we place it in the lower hole, it will be prepared to bone.

One of its main advantages is that it does not occupy any space on the work surface, so it can be placed all the time, being in use or not, without supposing an obstacle.

It is easy to install, as it is screwed into the wooden block.

### Caractéristiques:

Fabriqué en acier inoxydable AISI 304, ce porte-jambon est spécial pour installer sur un billot contenant un bloc en bois.

Sa conception robuste et résistante nous permet de placer le jambon dans deux positions différentes, l'une optimisée pour la découpe et l'autre pour le désossage. Donc, si nous mettons le jambon dans le trou supérieur, nous l'aurons dans la meilleure position pour le couper et si nous le plaçons dans le trou inférieur, il sera prêt pour le désosser.

L'un de ses principaux avantages est qu'il n'occupe aucun espace sur la surface de travail, il peut donc être placé tout le temps, qu'il soit utilisé ou non, sans supposer un obstacle.

Il est facile à installer, car il est vissé dans le bloc en bois.

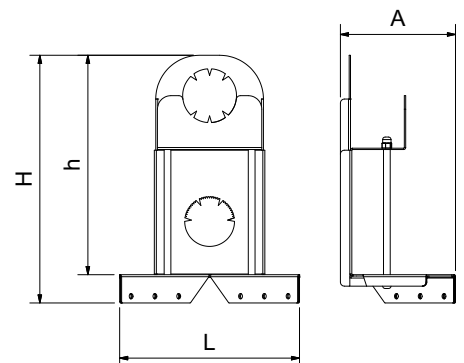

L	A	H	h	Kg	Barcode	€
267	171	368	326	2,77	041820	167,00

## Portalacones

Shoulder-ham holder  
Porte Jambon de Pays

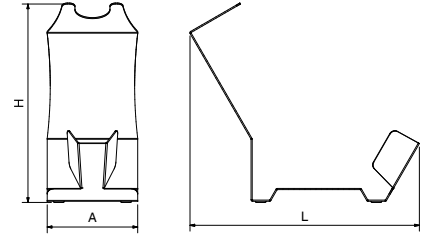

L	A	H	Kg	Barcode	€
393	155	340	2,2	041804	59,00

## Mesa jamonera RT-2D

Ham table RT-2D  
Table porte-jambon RT-2D



### Características:

Con nuestros novedoso sistema de soporte RT podrá trasladar el jamón de la barra expositora al jamonero en un instante. Fácil intercambio del jamón a cortar. El útil de acoplamiento RT que incorpora está diseñado para colocar instantáneamente el jamón en el jamonero. Rotación 360° en dos dimensiones. Profesional, este sistema le ayudará a exponer mejor el jamón, colocándolo en la posición más adecuada en cada momento, favoreciendo la facilidad y efectividad del corte. Higiénico, al tener un solo punto de apoyo y quedar el jamón suspendido, las labores de limpieza se facilitan al máximo. Con nuestros útiles de acoplamiento RT puede tener varios jamones expuestos y preparados para cortar en cualquier momento.



### Characteristics:

With our innovative RT support system you can move the ham from the display bar to the ham holder instantly. The ham is easily exchangeable. The built-in RT coupling tool is designed to instantaneously place the ham in the ham holder. Professional, this system will help you to display the ham better. In addition, you will be able to place it in the most appropriate position at each moment to cut it in an easy and effective way. 360° rotation in two dimensions. The ham is hold with one single supporting point, which results in an easy cleaning and better hygiene. With our RT coupling tools you can have several hams displayed and ready to cut at any time.

### Caractéristiques:

Avec notre nouveau système de support RT, vous pouvez déplacer le jambon de la barre d'exposition au support de jambon en un instant. Facile échange de jambon à couper. L'outil de couplage RT intégré est conçu pour placer instantanément le jambon dans le porte-jambon. Rotation à 360° en deux dimensions. Professionnel, ce système vous aidera à mieux exposer le jambon, en le plaçant dans la position la plus appropriée à chaque moment, en favorisant la facilité et l'efficacité de la coupe. Hygiénique, n'ayant qu'un seul point d'appui et laissant le jambon suspendu, les tâches de nettoyage sont facilitées au maximum. Avec nos outils de couplage RT, vous pouvez avoir plusieurs jambons exposés et prêts à couper à tout moment.

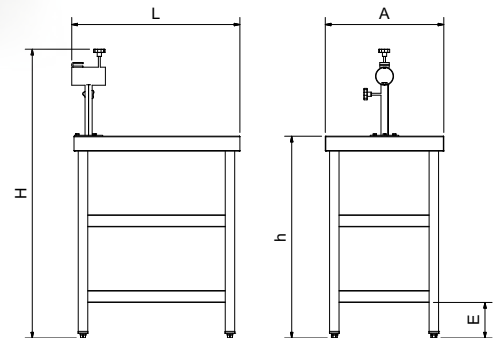

L	A	H	h	E	Kg	Barcode	€
710	500	1.220	850	150	20,00	074486	615,00

**Mesa jamonera RT-3D**  
 Ham table RT-3D  
 Table porte-jambon RT-3D

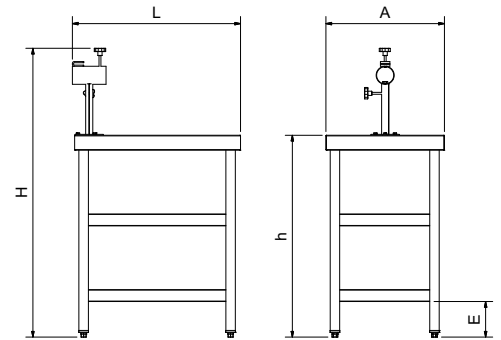

L	A	H	h	E	Kg	Barcode	€
710	500	1.220	850	150	20,00	074487	<b>695,00</b>



020102 37  
 Kit para colgar utensilios  
 Tool-holder kit  
 Kit pour suspendre outils



485002 497  
 Ruedas acopladas  
 Wheels  
 Rouelles



074490 175

Kits de portarrollos de papel o film serie Eco  
 Set of paper or film dispenser, Eco series  
 Kit de porte-rouleaux du papier ou film serie Eco

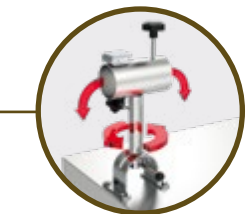

085480 494  
 Cajón o tolva acoplado  
 Drawer or hopper coupled  
 Tiror ou trémie accouplé

## Punto de venta portátil de jamones

Mobile sale point of hams

Point de vente de jambon portable



### Características de fabricación:

- Ruedas de  $\varnothing 75$  mm.
- 2 cajones pequeños
- 1 cajón grande
- 2 puertas abatibles
- 1 contenedor verde 486026
- 1 Portacuchillos con envoltivo
- 1 Dispensador de 1 caja de guantes
- 1 Dispensador de papel y bolsas triple
- 1 Kit portarrollos
- 1Pletina de 1500 mm. con 12 ganchos para jamones
- 1 base de jamonero giratorio basculante RT-3D
- 3 jamoneros giratorios RT-2D
- 1 fibra negra de 500x465x20 mm. con agujero de desbarasado
- Espacio disponible para báscula



### Manufacturing characteristics:

- Wheels  $\varnothing 75$  mm.
- 2 small drawers
- 1 large drawer
- 2 folding doors
- 1 green container 486026
- 1 Knife holder with casing
- 1 Dispenser for 1 glove box
- 1 Triple dispenser for paper and bags
- 1 Roll holder kit
- 1 1.500 mm bar with 12 hooks for hams
- 1 foot of tilting rotating ham holder RT-3D
- 3 rotary ham holders RT-2D
- 1 black cutting board of 500x465x20 mm with hole for disposals
- Enough room for a scale

### Caractéristiques de fabrication:

- Roues  $\varnothing 75$  mm.
- 2 petits tiroirs
- 1 grand tiroir
- 2 portes ouvrantes
- 1 container vert 486026
- 1 Porte-couteau avec enveloppant
- 1 Distributeur de 1 boîte à gants
- 1 Distributeur triple papier et sac
- 1 Kit de support de rouleau
- 1 Plaque de 1500 mm. avec 12 crochets pour les jambons
- 1 base de porte-jambon rotatif basculant RT-3D
- 3 porte-jambons rotatifs RT-2D
- 1 plaque noire de 500x465x20 mm. avec trou pour déchets
- Espace disponible pour la balance.

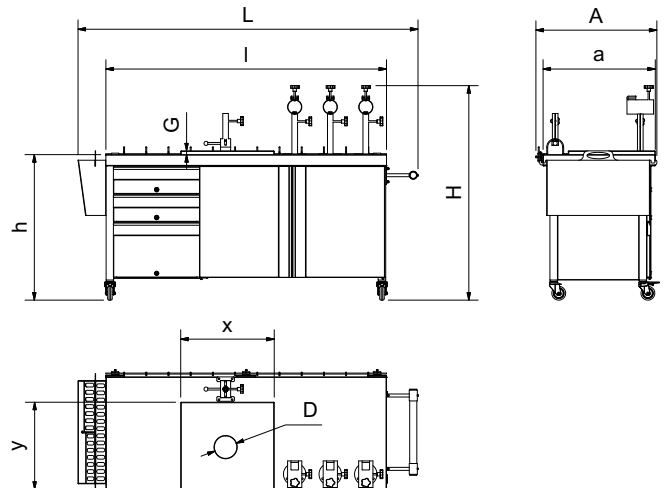

L	I	A	a	H	h	X	Y	G	D	Kg	Barcode	€
1.815	1.500	645	600	1.150	780	500	465	20	120	98,00	075230	3.310,00

## Estante abatible de fibra para punto de venta portátil de jamones

Polyethylene hinged shelf for mobile sale point of hams

Étagère ouvrante en fibre pour point de vente de jambon portable

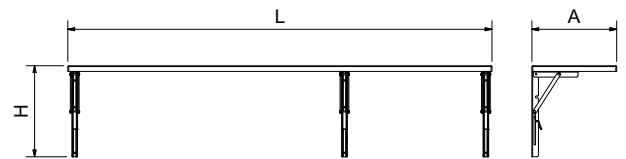

L	A	H	Kg	Barcode	€
1.500	300	325	10,3	075232	<b>306,00</b>

## Plafones para exposición de embutidos

Sausage display boards

Panels d'exposition pour charcuterie



Gancho opcional 9200606022502  
Optional hook 9200606022502.  
Crochet optionnel 9200606022502.



46

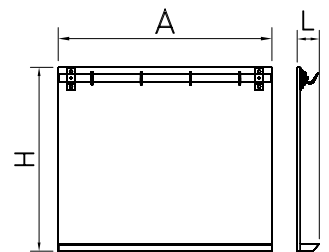

A	L	H	Nº Ganchos Hooks Crochets	Kg	Barcode	€
800	110	865	3	10	024202	<b>195,00</b>
1.000	110	865	4	11	024204	<b>270,00</b>
1.500	110	865	5	15	024206	<b>290,00</b>

## Cono recoge grasas antigoteo para jamón

Anti-drip drain cone for ham grease

Cône pour récupérer la graisse, anti-goutte pour le jambon



Pack de 25 unidades.  
Pack of 25 units.  
Pack de 25 unités.

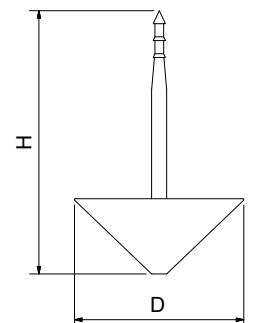

H	D	Gr	Barcode	€
140	90	150	9403801445602	<b>35,00</b>



## Set para corte de jamón

Ham slicing set  
Set pour couper le jambon



Completo set de herramientas para el corte de jamón que incluye:

Bolsa de transporte con alojamiento para cada cuchillo, además de solapas para tarjetas de visita, bolígrafos, etc.

Chaira 447202.

Pinza jamonera.

Cuchillo jamonero (largo de hoja 290 mm).

Cuchillo deshuesador de jamón.



Complete set of tools for slicing ham consisting of:  
Carrying bag with provided with lodging for each knife along with slots for business cards, pens, etc.  
Sharpener (ref. 447202).  
Ham tweezers.  
Ham knife (length of blade 290 mm).  
Ham boning knife.

Ensemble complet d'outils pour la découpe du jambon qui inclus:  
Sac de transport avec logement pour chaque couteau, ainsi que des volets pour les cartes de visite, stylos, etc.  
Fusil à affûter 447202.  
Pince à jambon.  
Couteau à trancher (longueur de la lame 290 mm).  
Couteau à jambon de désossage.

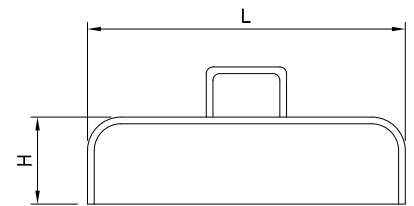

L	H	Gr	Barcode	€
475	135	740	448062	<b>41,50</b>

## Jamón serrano virola

Ferrule slicing knife for cured ham  
Couteau à jambon de montagne à virole

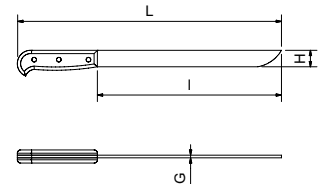

L	I	H	G	Tipo Type Type	Gr	Barcode	€
380	260	22	2,00	↑	135	445402	<b>33,00</b>
460	310	22	2,16	↑	150	445406	<b>38,50</b>

## Jamón serrano

Slicing knife for cured ham  
Couteau à jambon de montagne

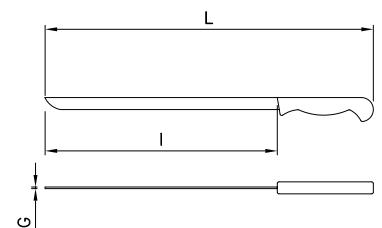

L	I	H	G	Tipo Type Type	Gr	Barcode	€
390	250	20	1,5	STD	105	445202	<b>13,00</b>
440	300	20	1,6	STD	120	445204	<b>15,00</b>

**Jamón serrano punta redonda**  
 Knife for cured ham, round tip  
 Couteau à jambon avec pointe ronde

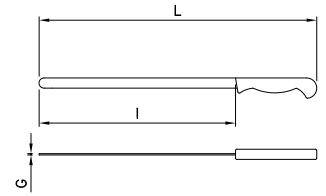

L	I	H	G	Tipo Type Type	Gr	Barcode	€
300	32		2,5	STD	160	440460	18,50

**Jamón serrano alveolado punta redonda**  
 Fluted slicing knife for cured ham, round tip  
 Couteau alvéolé pour jambon de pays avec pointe ronde

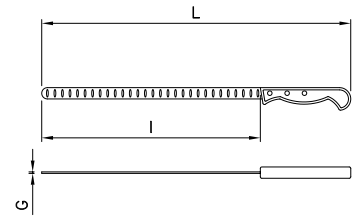

L	I	H	G	Tipo Type Type	Gr	Barcode	€
410	290		1,5	STD	115	445206	24,50

**Gubia deshuesar jamón**  
 Ham boning gouge  
 Gouge à désosser jambon



L	I	H	Tipo Type Type	Gr	Barcode	€
385	240	40	STD	370	444602	53,00

**Deshuesar jamón**  
 Ham boning knife  
 Désosseur jambon

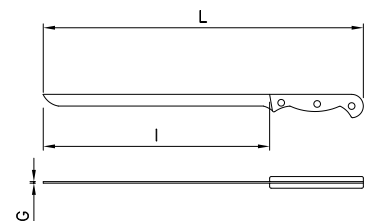

L	I	H	G	Tipo Type Type	Gr	Barcode	€
340	205	22	3,2	STD	140	445802	19,00
435	300	25	3,0		165	445806	22,00



**Deshuesar jamón**  
Ham boning knife  
Désosseur jambon

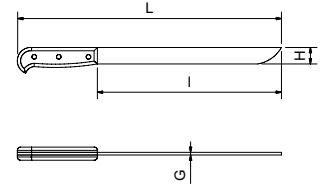

				Uso general General use Usage generale	Aves Poultry Volailles	Pescados Fish Poissons	Frutas y verduras Fruits & Vegetables Fruits et légumes	Carnes Meat Viandes			
L	I	H	G	Tipo Type Type	Gr	€					
270	130	20	2,43		115	<b>10,00</b>	445850	445882	445858	445874	445866
290	150	23	2,45	STD	120	<b>10,50</b>	445852	445884	445860	445876	445868

**Deshuesar jamón curvo**  
Ham curved boning knife  
Désosseur jambon courbe

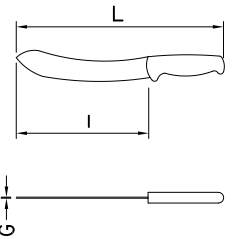

I	H	G	Tipo Type Type	Gr		€
180	31	2,5	STD	118	445820	<b>12,00</b>

**Pinzas para embutidos**  
Meat tongs  
Pincas saucisse

		L	A	Gr		€
		200	5	25	440068	<b>7,00</b>
		120	100	15	440070	<b>8,00</b>
		100	50	120	440030	<b>11,00</b>



## Cuchillería profesional para pescaderos

Professional cutlery for fishmongers  
Coutellerie professionnelle pour poissonniers

**Pescadero**  
Fish knife  
Couteau à poisson

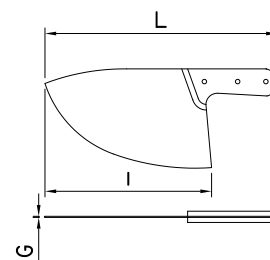

	L	I	H	G	Tipo Type Type	Gr	Barcode	€
	420	305	190	1,53	†	670	446002	<b>86,00</b>
	460	340	190	1,53	†	735	446004	<b>83,00</b>
	475	355	200	1,53	†	790	446006	<b>91,00</b>
	495	375	215	1,73	†	850	446008	<b>112,50</b>
	440	320	105	1,76	STD	555	446202	<b>53,50</b>
	470	340	120	1,72	STD	650	446204	<b>58,50</b>
	490	360	135	1,90	STD	725	446206	<b>64,00</b>
	420	290	105	1,4	STD	480	446012	<b>60,00</b>
	415	300	120	1,5	STD	520	446014	<b>65,00</b>
	280	74	3,0	STD	†	284	446220	<b>34,00</b>

**Escamador**  
Scale removers  
Ecailleurs

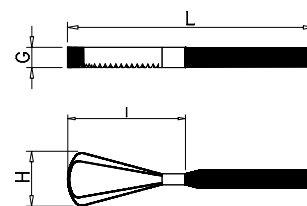

L	I	H	G	Gr	Barcode	€
270	95	60	20	215	040202	<b>21,00</b>

**Escamador EC**  
Scale removers EC  
Ecailleurs EC

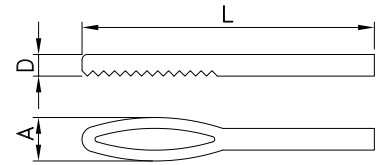

L	A	D	Gr	Barcode	€
265	40	22	180	440052	7,50

**Bacaladera**  
Cod knife  
Couteau à morue

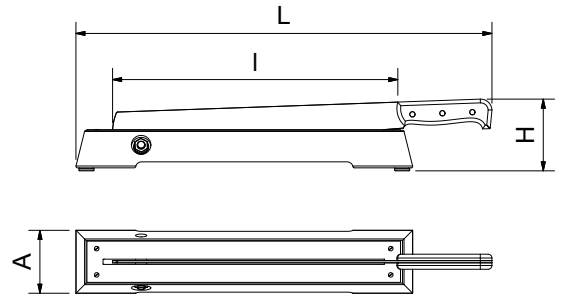

L	A	H	I	Gr	Barcode	€
550	85	110	300	2.185	446602	144,50

**Abreostras**  
Oyster opener  
Ouvre-huîtres



⚠ Se fija a la mesa mediante mordaza.  
Table fixing by clamp.  
Fixation au table sur mordache.

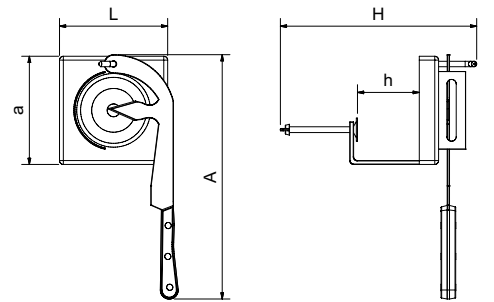

L	A	a	H	h	Kg	Barcode	€
140	325	140	250	75	1,16	447802	153,50

**Abreostras**  
Oyster opener  
Ouvre-huîtres

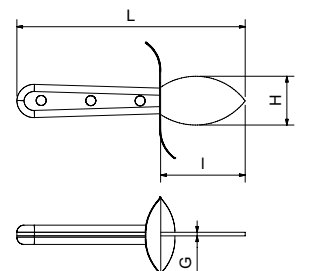

L	I	H	G	Gr	Barcode	€
165	65	85-32	2,4	120	447804	17,50

**Abre ostras de polietileno**  
Polyethylene oyster opener  
Ouvre-huîtres en polyéthylène

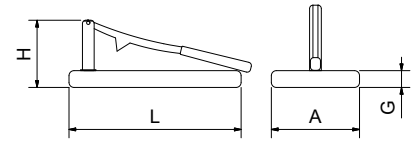

L	A	H	G	Kg	Barcode	€
205	105	80	20	1,6	447806	<b>39,50</b>

**Abre ostras manual profesional en acero inoxidable**  
Professional manual oyster opener in stainless steel  
Ouvre-huîtres manuel professionnel en acier inoxydable

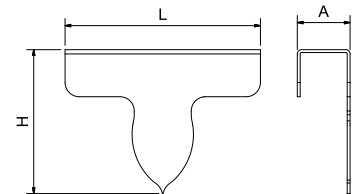

L	A	H	Gr	Barcode	€
137	37	101	250	040250	<b>8,00</b>

**Abre ostras profesional de sobremesa en acero inoxidable**  
Professional tabletop stainless steel oyster opener  
Ouvre huîtres professionnel sur table en acier inoxydable



**N**ovedad  
NEW  
NOUVEAU

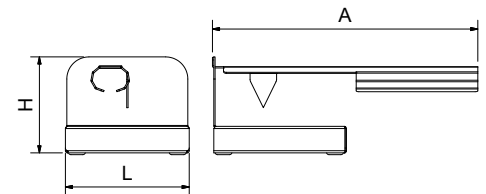

L	A	H	Gr	Barcode	€
140	300	110	890	040252	<b>39,00</b>

**Detector de anisakis**  
Anisakis detection kit  
Kit détection Anisakis

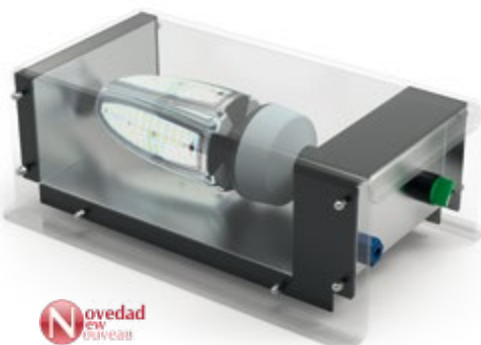

Este novedoso y patentado sistema permitirá detectar el Anisakis y otros parásitos de forma sencilla, tanto en pescaderías como plantas procesadoras de pescado.

This innovative and patented system will allow the detection of Anisakis and other parasites in a simple way, both in fishmongers and fish processing plants.

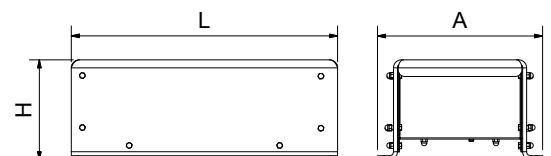

L	A	H	Tensión Voltage Tension	Frecuencia Frequency Fréquence	Kg	Barcode	€
400	248	155	220/240V	50/60 Hz	2,96	042802	<b>218,00</b>

Ce système novateur et breveté permettra la détection des Anisakis et autres parasites de manière simple, aussi bien dans les poissonneries que dans les usines de transformation du poisson.



Cuchillería profesional para cocineros  
Professional cutlery for cooks  
Coutellerie professionnelle pour chefs

AD



CUCHILLERÍA PREMIUM  
PREMIUM CUTLERY  
COUTELLERIE PREMIUM

Cuchillería forjada  
Forged knives  
Couteaux forgé

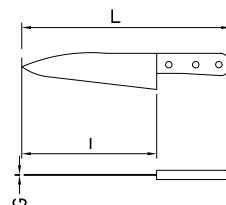

L	I	H	G	Tipo Type	Gr	Barcode	€
255	150	30	2,80		115	440204	<b>32,00</b>
320	200	40	2,75		190	440206	<b>40,00</b>
370	250	50	3,40		280	440208	<b>51,00</b>
430	295	55	3,50		375	440210	<b>69,00</b>
490	350	65	3,60		500	440212	<b>89,00</b>

Cocinero forjado  
Forged chef knife  
Couteau cocineto forgé

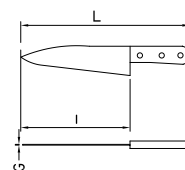

L	I	H	G	Tipo Type	Gr	Barcode	€
240	130	20	1,7		91	440202	<b>7,16</b>

**Pelador forjado**  
 Forged paring knife  
 Couteau éplucheur forgé

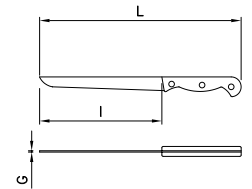

L	I	H	G	Tipo Type	Gr	Barcode	€
205	90	20	1,7		87	444220	<b>7,06</b>

**Panero forjado**  
 Forged bread knife  
 Couteau à pain forgé

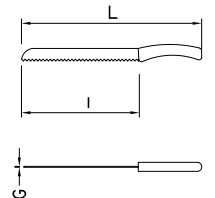

L	I	H	G	Tipo Type	Gr	Barcode	€
330	200	28	2		174	448010	<b>9,78</b>

**Trinchar forjado**  
 Forged carving Knife  
 Couteau à découper forgé

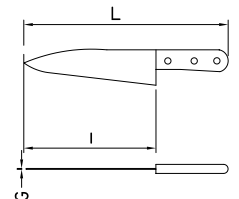

L	I	H	G	Tipo Type	Gr	Barcode	€
335	200	28	2		165	440250	<b>9,44</b>

**Deshuesar forjado**  
 Forged boning Knife  
 Couteau à désosser forgé

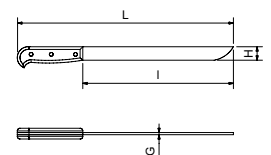

L	I	H	G	Tipo Type	Gr	Barcode	€
290	160	25	2		148	445830	<b>9,13</b>

**Cocina alveolado**  
 Fluted kitchen knife  
 Cuisine alvéolée

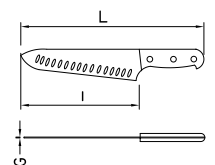

I	H	G	Tipo Type	Gr	Barcode	€
250	50	2,5	STD	290	440430	<b>41,00</b>



Características de fabricación:

SEGURIDAD EN UN DISEÑO PROBADO. Hace más de 30 años, ZWILLING J.A. HENCKELS revolucionaba los estándares para los cuchillos de cocina de alta calidad al crear el mango sintético sin juntas.

- Material de mango: sintético.
- Transición sin juntas del cabezal al mango.
- Acero inoxidable y fundición especial.
- Hoja endurecida al frío con FRIODUR.
- Cuchillos SIGMAFORGE hoja forjada de una única pieza.

Manufacturing characteristics: SAFETY IN A PROVEN DESIGN. More than 30 years ago ZWILLING J.A. HENCKELS revolutionised the standards for top-quality knives with this seamless synthetic handles.

- Handle material: synthetic.
- Seamless transition from bolster to handle.
- Stainless steel and special smelting.
- FRIODUR knife, ice-hardened.
- SIGMAFORGE knife - forged from one piece.

Caractéristiques de fabrication: LA SECURITE D'UN MODELE QUI A FAIT SES PREUVES. Il y a plus de 30 ans, ZWILLING J.A. HENCKELS révolutionna les normes des couteaux de qualité optimale avec ces manches synthétique homogènes.

- Manche: synthétique.
- Transition homogène entre la mitre et le manche.
- Acier inoxydable unique, formule spéciale.
- Couteau FRIODUR en acier trempé.
- Couteau SIGMAFORGE - forgé d'une seule pièce.

Puntilla

Paring knife  
Couteau d'office

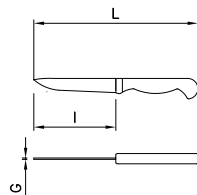

L	I	H	G	Tipo Type Type	Gr	Barcode	€
205	100	20	1,0		54	447302	<b>73,00</b>

Universal dentado

Universal knife  
Couteau universel

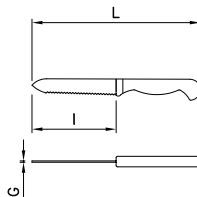

L	I	H	G	Tipo Type Type	Gr	Barcode	€
230	130	20	1,0		58	447304	<b>65,00</b>

Filetear

Fillet knife  
Filet de couteau

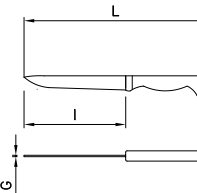

L	I	H	G	Tipo Type Type	Gr	Barcode	€
290	160	29	1,0		112	447306	<b>79,00</b>
318	200	29	2,0		122	447308	<b>88,00</b>
370	260	29	2,0		144	447310	<b>109,00</b>

Jamonero

Ham knife  
Couteau à jambon

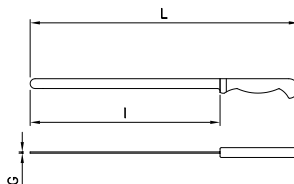

L	I	H	G	Tipo Type Type	Gr	Barcode	€
431	300	17	2,0		148	447312	<b>125,00</b>

Cebollero

Onion knife  
Couteau oignon

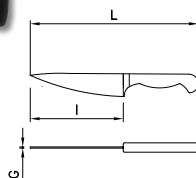

L	I	H	G	Tipo Type Type	Gr	Barcode	€
329	200	41	3,0		212	447314	<b>109,00</b>

# Cuchillería Victorinox

Victorinox knives  
Couteaux Victorinox



**Características de fabricación:**  
Los cuchillos profesionales de Victorinox se caracterizan por sus resistentes materiales de primera calidad que se adaptan a la mano y se ajustan con precisión a cada aplicación. La dureza correcta de la hoja y el ángulo de corte controlado por láser garantizan una elevada eficiencia de corte.

**Manufacturing characteristics:**  
The professional knives Victorinox are characterized by their durable materials of first quality. They fit the hand and conform precisely to each use. The right blade hardness and the laser-tested cutting angle guarantee high cut efficiency.

**Caractéristiques de fabrication:**  
Les couteaux professionnels Victorinox sont caractérisés par leurs matériaux durables et de première qualité. Ils s'ajustent à la main et de s'adaptent parfaitement à chaque utilisation. La correcte dureté de lame et l'angle de coupe contrôlé par laser garantit coupe à haut rendement.

## Salmón

Salmon knife  
Couteau à saumon

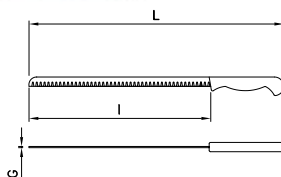

L	I	H	G	Tipo Type	Gr	Barcode	€
442	300	21	1,8	STD	150	445902	<b>75,00</b>

## Despellejar

Skinning knife  
Ecorcheur

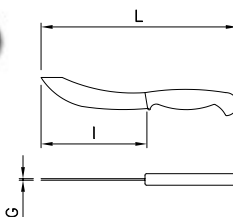

L	I	H	G	Tipo Type	Gr	Barcode	€
282	150	37	2,0	STD	130	445904	<b>40,00</b>

## Deshuesar

Boning knife  
Couteau à désosse

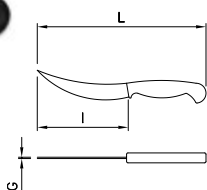

L	I	H	G	Tipo Type	Gr	Barcode	€
282	150	22	2,5	STD	125	445914	<b>31,00</b>

## Carnicero

Butcher  
Boucher

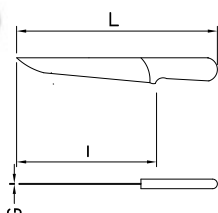

L	I	H	G	Tipo Type	Gr	Barcode	€
297	160	36	2,5		125	445906	<b>40,00</b>
337	200	36	2,5	STD	170	445908	<b>53,00</b>
397	260	51	2,5		220	445910	<b>59,00</b>

## Fileteador flexible

Flexible filleting knife  
Couteau à filet flexible

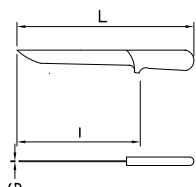

L	I	H	G	Tipo Type	Gr	Barcode	€
340	210	20	1,5	STD	135	445912	<b>45,00</b>



### Características de fabricación:

Elegante, de líneas limpias y depuradas, así nace el diseño de Meeting®.  
 Esta versión de acero inoxidable se presenta sobre madera de roble de Borgoña.  
 Materiales atemporales y elegantes, Meeting® sabe mezclar estética y funcionalidad.

### Manufacturing characteristics:

The result of the Meeting® conception is an elegant design with clean and refined lines.  
 This stainless steel version is presented on burgundy oak wood.  
 Timeless and elegant materials, Meeting® knows how to merge aesthetics and functionality.

### Caractéristiques de fabrication:

Des lignes nettes et épurées, voici le design Meeting®.  
 En version tout inox ainsi que dans une toute nouvelle présentation avec un support en chêne de Bourgogne. Matériaux intemporels et élégants, Meeting® sait mêler esthétique et fonctionnalité.

AD

## Deglon Meeting 3 piezas

Deglon Meeting knife set 3 pc  
 Deglon Meeting set de couteaux 3 pc

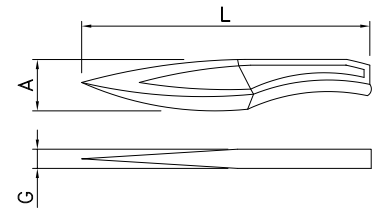

### Características:

El estuche contiene: un cuchillo cocinero, un cuchillo de trinchar y una puntilla.

Portacuchillos de madera de roble de Borgoña.

L	A	G	Gr	Barcode	€
300	75	20	500	440102	499,00

### Characteristics:

This boxed set comprises: one paring knife, one kitchen knife, one carving knife.

Oak support of Burgundy.

### Caractéristiques:

Ce coffret comprend: un couteau d'office, un couteau de cuisine, un couteau à découper..

Support chêne de Bourgogne.





CUCHILLERÍA ESTANDAR  
STANDARD CUTLERY  
COUPELLERIE STANDARD

**Modelo cocina**  
Chef knives  
Modèle chef

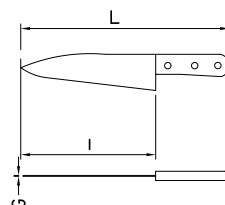

	L	I	H	G	Tipo Type Type	Gr	Barcode	€
	325	200	45	2,77		155	440450	<b>18,00</b>
	350	225	48	2,70	STO	180	440452	<b>20,00</b>
	425	300	60	2,60		205	440454	<b>26,00</b>
	200	105	24	1,6		50	440400	<b>9,00</b>
	265	150	40	2,0		120	440402	<b>13,00</b>
	295	180	45	2,0		140	440404	<b>15,00</b>
	320	200	49	2,8	STO	190	440406	<b>18,00</b>
	350	230	45	2,5		190	440408	<b>21,00</b>
	375	255	57	2,5		150	440410	<b>22,50</b>
	435	305	60	2,8		310	440412	<b>28,50</b>
	475	345	70	2,8		390	440414	<b>26,50</b>

**Cuchillo francés inyectado Adherent+**  
French knife with injected handle Adherent+  
Couteau français injecté Adherent+

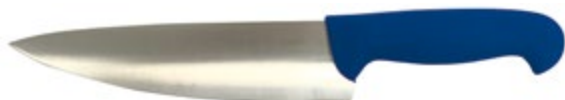

El material plástico empleado en el mango garantiza una máxima adherencia.

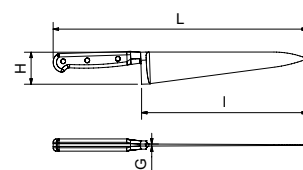

The plastic material used in the handle guarantees the maximal adherence

Le matériel en plastique utilisé dans la poignée garantit une adhérence maximale.

L	I	H	G	Tipo Type Type	Gr	Barcode	€
310	195	48	3	STO	160	444090	<b>17,00</b>

## Cuchillo todos usos

Multipurpose Knife  
Couteau tous usages

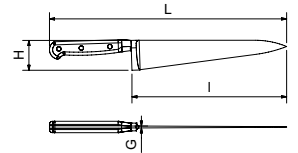

				Uso general General use Usage generale	Aves Chickens Volailles	Pescados Fish Poissons	Frutas y verduras Fruits & Vegetables Fruits et légumes	Carnes Meat Viandes			
L	I	H	G	Tipo Type	Gr	€	Barcode	Barcode	Barcode	Barcode	Barcode
310	175	35	2,6		135	<b>12,50</b>	444002	444074	444020	444056	444038
335	205	60	2,6		160	<b>17,00</b>	444004	444076	444022	444058	444040
355	220	40	2,6	STD	190	<b>19,50</b>	444006	444078	444024	444060	444042
380	250	50	2,6		210	<b>20,50</b>	444008	444080	444026	444062	444044
430	305	50	2,6		275	<b>24,00</b>	444010	444082	444028	444064	444046
485	350	55	2,6		330	<b>31,00</b>	444012	444084	444030	444066	444048

AD

## Cuchillo cocinero con filo dentado

Double shopping trolley bay  
Parking double pour caddies



**N**ovedad  
Nouveauté

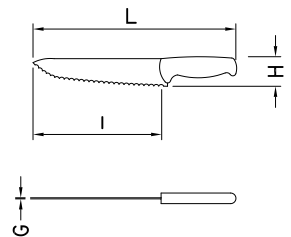

L	I	H	G	Tipo Type	Gr	Barcode	€
310	200	45	1,8	STD	120	440440	<b>28,00</b>

## Lenguado

Fish fillet knife  
Sole

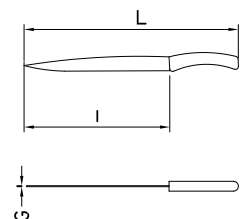

L	I	H	G	Tipo Type	Gr	Barcode	€
290	170	25	1,4	STD	115	446050	<b>29,00</b>

**Cuchillo antioxidante para verduras**  
 Anti-oxidation knife for vegetables  
 Couteau antioxydant pour légumes



L	I	H	G	Gr	Barcode	€
300	190	40	2	65	440066	<b>3,00</b>

**Santoku**  
 Santoku knife  
 Couteau Santoku

L	I	H	G	Tipo Type	Gr	Barcode	€
300	180	36	2,0	STD †	160	447116	<b>11,50</b>
180	52	2,5	STD †	176	447126	<b>23,00</b>	

**Pelador**  
 Peeling knife  
 Éplucheur



L	I	H	G	Tipo Type	Gr	Barcode	€
170	65	20	1,53	STD †	35	444204	<b>6,00</b>

**Puntilla**  
 Dagger  
 Proignard



L	I	H	G	Tipo Type	Gr	Barcode	€
215	100	21	1,8	STD †	50	444404	<b>8,00</b>
280	150	40	1,8	STD †	60	444406	<b>11,50</b>

**Cortar pan**  
Bread knife  
Couteau à pain

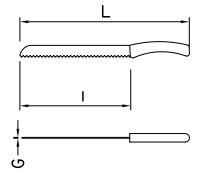

L	I	H	G	Tipo Type	Gr	Barcode	€
345	215	25	1,8	STD	110	448002	<b>12,50</b>

**Cuchillo panero de hoja ancha**  
Wide blade bread knife  
Couteau à pain à lame large

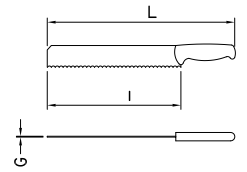

L	I	H	G	Tipo Type	Gr	Barcode	€
450	320	52	2,2	STD	230	448004	<b>38,00</b>

**Cuchillo panero de mango elevado y filo ondulado**  
Wavy edge bread knife, elevated handle  
Couteau à pain à manche haut avec bord ondulé

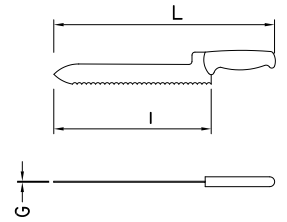

L	I	H	G	Tipo Type	Gr	Barcode	€
360	230	50	1,2	STD	120	448006	<b>28,00</b>

**Cuchillo panero especial pizza**  
Bread knife, special for pizza  
Couteau à pain spécial pizza

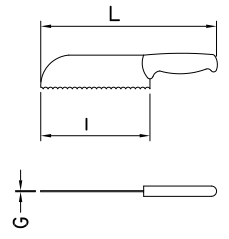

L	I	H	G	Tipo Type	Gr	Barcode	€
280	160	45	1,9	STD	120	448008	<b>30,00</b>

**Cuchillo especial alimentos congelados**  
Frozen food knife  
Couteau spécial pour aliments surgelés

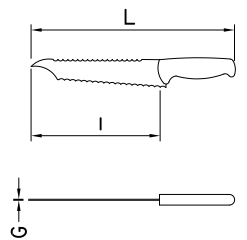

L	I	H	G	Tipo Type	Gr	Barcode	€
380	260	33	2,2	STD	130	448040	<b>40,50</b>

# Cuchillería titanio

Titanium knives  
Couteaux titane



## Deshuesador

Boning knife  
Désosseur

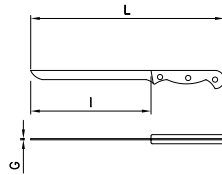

I	H	G	Tipo Type	Gr	Barcode	€
150	20	1,8	STO	96	446518	23,50

## Cocinero

Chef knife  
Couteau de cuisine

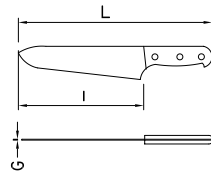

I	H	G	Tipo Type	Gr	Barcode	€
200	50	2,5	STO	207	446502	46,00

## Verduras

Vegetable knife  
Légumes

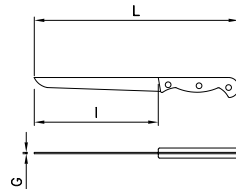

I	H	G	Tipo Type	Gr	Barcode	€
130	23	1,8	STO	54	446528	17,00

## Jamonero

Ham knife  
Couteau à jambon

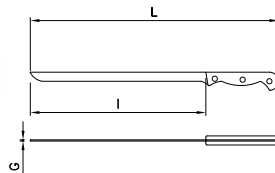

I	H	G	Tipo Type	Gr	Barcode	€
300	25	1,8	STO	122	446520	36,00

## Santoku

Santoku knife  
Couteau Santoku

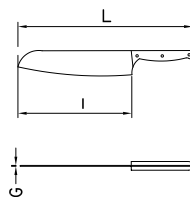

I	H	G	Tipo Type	Gr	Barcode	€
180	50	2,5	STO	176	446522	37,00

## Panero

Bread knife  
Couteau à pain

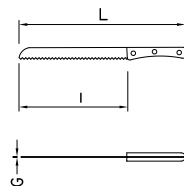

I	H	G	Tipo Type	Gr	Barcode	€
200	25	2,5	STO	147	446524	29,00

## Salmón

Salmon knife  
Couteau à saumon

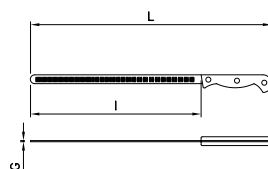
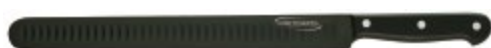

I	H	G	Tipo Type	Gr	Barcode	€
300	30	2,5	STO	177	446526	58,00

# Cuchillería con revestimiento antiadherente ILAFLON RESIST™

Knives with nonstick coating ILAFLON RESIST™

Couteaux à revêtement antiadhésif ILAFLON TM RESIST™



## Características de fabricación:

Sistema de revestimiento antiadherente ILAFLON RESIST™, bi-capa de alta resistencia, con refuerzo cerámico.

Estas dos capas se combinan de forma óptima para crear una película que presenta un excelente efecto antiadherente, de esta forma se consigue que el corte se desprenda fácilmente de la hoja.

- Anti-adherente
- Mayor agilidad al cortar
- Anti-corrosión
- Anti-manchas
- Mejor desinfección y limpieza

## Manufacturing characteristics:

ILAFLON RESIST™: Nonstick coating system ILAFLON RESIST™, with high strength two-layer coating and ceramic reinforcement.

These two layers are combined in an optimal way in order to create a film with an excellent nonstick effect. In this way any cut you make will be detached from the blade easily.

- Nonstick.
- Cutting agility.
- Anti-corrosion.
- Stain-resistant.
- Better sanitation.

## Caractéristiques de fabrication:

ILAFLON TM RESIST™: Système de revêtement antiadhésif ILAFLON RESIST™, avec haute résistance à deux couches de revêtement et renforcement de céramique.

Ces deux couches sont combinées de manière optimale afin de créer un film avec un effet anti-adhésif excellent. De cette façon, toute tranche que vous faites sera détachée de la lame facilement.

- Revêtement antiadhésif.
- Agilité de coupe.
- Anti-corrosion.
- Résistant aux taches.
- Meilleur assainissement.

AD

### Puntilla Paring knife Couteau d'office

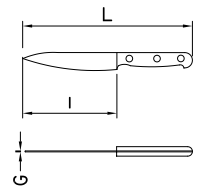

L	I	H	G	Tipo Type	Gr	Barcode	€
210	100	21	1,5	STD ↑	51	446702	16,00

### Cocinero Chef knife Couteau de cuisine

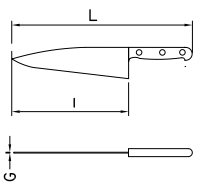

L	I	H	G	Tipo Type	Gr	Barcode	€
320	200	49	3,0	STD ↑	203	446704	40,00
370	250	53	3,0		263	446706	50,00
420	300	67	3,0		441	446708	86,00

### Panero Bread knife Couteau à pain

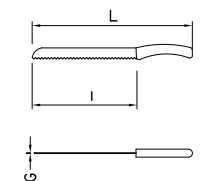

L	I	H	G	Tipo Type	Gr	Barcode	€
330	200	29	2,0	STD ↑	144	446710	33,00

### Jamonero Ham knife Couteau à jambon

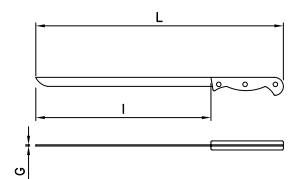

L	I	H	G	Tipo Type	Gr	Barcode	€
410	300	15	1,8	STD ↑	95	446712	32,00

# Cuchillería cerámica

Ceramic knives  
Couteaux en céramique



## Cocina

Kitchen chef's knife  
Couteau chef

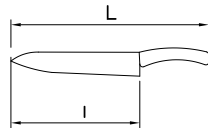

L	I	H	Tipo Type	Gr	Barcode	€
270	150	35		107	446116	<b>13,00</b>
295	175	40	STD	138	446118	<b>17,00</b>
320	200	43		154	446120	<b>21,00</b>

## Panero

Bread knife  
Couteau à pain

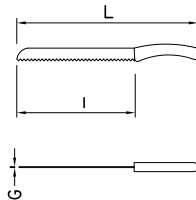

L	I	H	Tipo Type	Gr	Barcode	€
275	155	30	STD	104	446114	<b>15,00</b>

## Santoku

Santoku knife  
Couteau Santoku

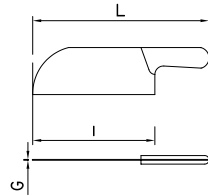

L	I	H	Tipo Type	Gr	Barcode	€
225	123	33	STD	169	446112	<b>13,50</b>

## Puntilla

Dagger  
Proignard

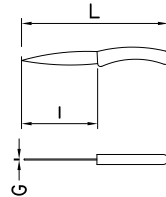

L	I	H	Tipo Type	Gr	Barcode	€
175	75	20		39	446106	<b>7,00</b>
200	100	20	STD	43	446108	<b>7,60</b>

## Utilitario

Utility  
Utilitaire

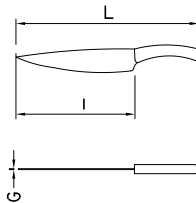

L	I	H	Tipo Type	Gr	Barcode	€
230	125	25	STD	58	446110	<b>10,00</b>

## Pelador de cerámica

Ceramic peeler  
Couteau éplucheur en céramique

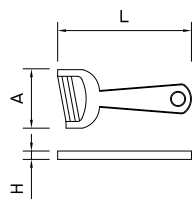

L	A	H	Gr	Barcode	€
---	---	---	----	---------	---









120 50 20 75 446122 **4,50**

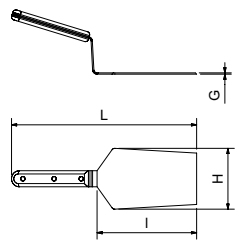

140 80 30 27,2 446124 **6,50**

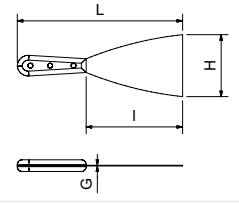

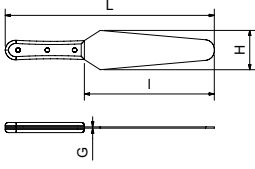
**Paletas y espátulas**  
Grill turners and spatulas  
Palettes et spatule

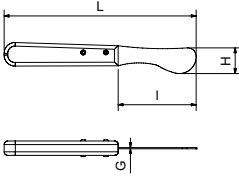
		L	I	H	G	Gr	Barcode	€
		290	160	95	2	320	441602	<b>21,00</b>
		230	130	95	1	115	441206	<b>15,90</b>
		215	125	26	1,0	65	441402	<b>10,00</b>
		255	155	26	1,0	70	441404	<b>12,00</b>
		335	205	40	1,0	170	441406	<b>20,00</b>
		385	255	45	1,0	190	441408	<b>20,50</b>
		440	315	45	1,5	205	441410	<b>30,00</b>
490	365	45	1,5	265	441412	<b>31,00</b>		
		160	65	23	1	35	441002	<b>2,60</b>

**Aguja de mechar**  
Stuffing needle  
Aiguille lardoire



L	I	H	G	Gr	Barcode	€
200	130	10	6	100	440802	<b>14,50</b>

**Tenedor de trinchar**  
Carving fork  
Fourchette de chef

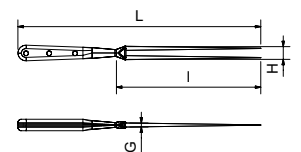

L	I	H	G	Gr	Barcode	€
300	170	16	5,4	150	440602	<b>40,00</b>

**Tenedor trinchar EC**  
Carving fork EC  
Fourchette de chef EC

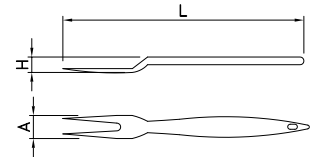

L	A	H	Gr	Barcode	€
320	60	40	100	440040	<b>3,50</b>

**Pelador**  
Peeler  
Éplucheur

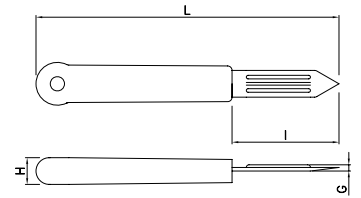

L	I	H	G	Gr	Barcode	€
215	75	20	3,65	54	446902	<b>2,50</b>

**Pelador de espárragos**  
Asparagus peeler  
Éplucheur d'asperges

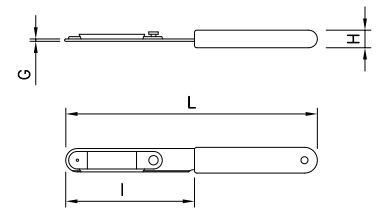

L	I	H	G	Gr	Barcode	€
215	107	10	3	55	446922	<b>16,50</b>

**Rizador de mantequilla**  
Butter curler knife  
Coquilleur à beurre

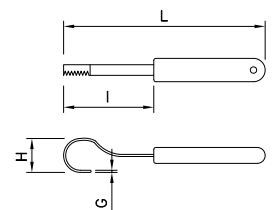

L	I	H	G	Gr	Barcode	€
190	84	10	2	53	446920	<b>6,50</b>

**Rallador**  
Grater  
Râpe

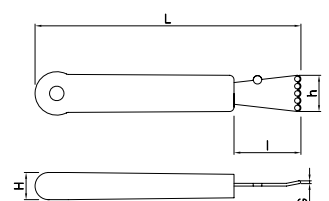

L	I	H	G	h	Gr	Barcode	€
180	45	20	2	20	54	446904	<b>2,75</b>

**Acanalador**  
Cannelle knife  
Zesteur canneléur

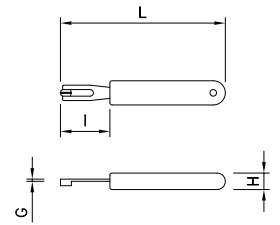

L	I	H	G	Gr	Barcode	€
150	44	10	2	41	446918	<b>6,50</b>

**Vaciador doble**  
Melon baller scoop  
Couteau à vider double

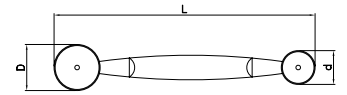

L	D	d	Gr	Barcode	€
170	30	22	53	446910	<b>15,00</b>

**Descorazonador**  
Corer  
Couteau carottier

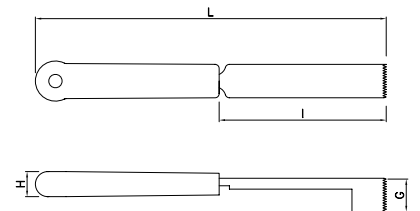

L	I	H	G	Gr	Barcode	€
215	80	15	19,6	55	446906	<b>2,85</b>

**Decorador de fruta**  
V-shaped garnishing knife  
Couteau décorateur de fruit

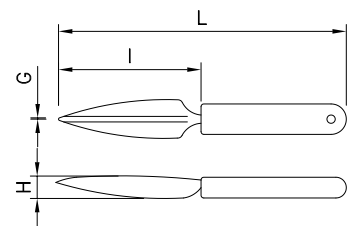

L	I	H	G	Gr	Barcode	€
210	105	15	2	54	446916	<b>6,00</b>

**Decorador**  
Garnishing knife  
Couteau à décorer

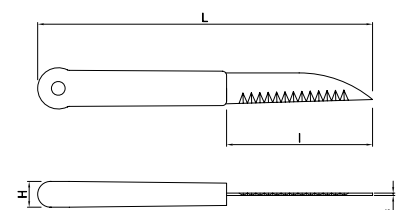

L	I	H	G	Gr	Barcode	€
190	85	17	1,5	36	446912	<b>16,50</b>

## Set de decoración

Garnishing set  
Décor set



### Contenido del set de decoración:

5 cuchillos talladores.  
Una esfera de  $\varnothing$  20 mm. (melón)  
Un cuchillo en forma de hoz.  
Una chaira de cerámica.

### Garnishing set content:

5 carving knives.  
Melon baller  
Sickle-shaped knife  
Ceramic sharpener

### Contenu du set:

5 couteaux à découper.  
Cuillère à melon  
Couteau faucille  
Fusil à aiguiser en céramique



210 448058 **98,00**

## Tomate

Tomato knife  
Couteau à tomate

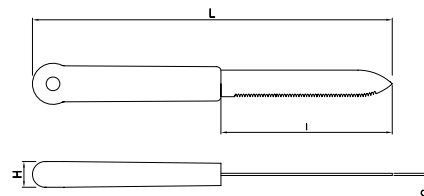

L I H G Gr 220 100 20 1,1 54 446914 **3,50**

## Cuchillo cortador de tajadas de sandía o melón

Watermelon or melon slicer knife  
Couteau spécial tranche de pastèque ou melon

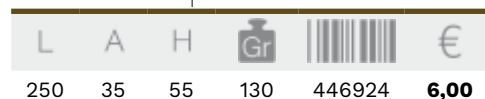
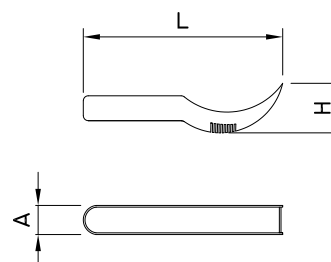

L A H Gr 250 35 55 130 446924 **6,00**



### Aplastafiletas circular

Meat pounder with round handle  
Aplatisseur ronde

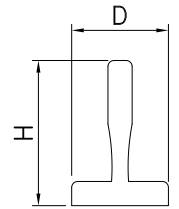

H	D	Gr	441806	€
120	80	2.000	441806	55,00

### Aplastafiletas

Filet flattener  
Ecrasse-steak

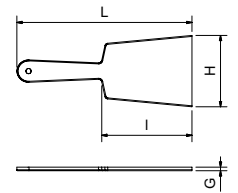

L	I	H	G	Gr	441802	€
270	135	110	5,5	685	441802	46,00
340	120	100	9,0	1.155	441804	88,00

### Recoge verduras

Vegetable plate  
Plaque de légumes

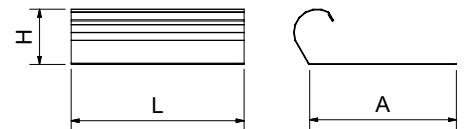

L	H	A	Gr	040220	€
175	56	150	350	040220	13,00

### Kit de útiles para barbacoa

BBQ utensil set  
Kit d'accessoires pour barbecue

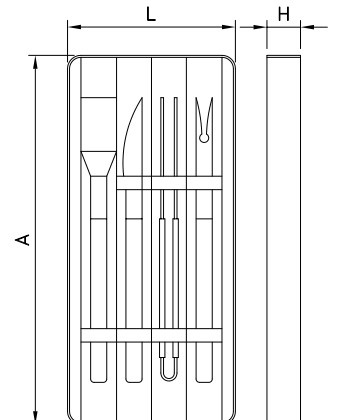

L	A	H	Gr	440062	€
550	250	50	950	440062	77,00

# Tijeras

Scissors  
Ciseaux

## Tijeras pescadero

Fish scissors  
Ciseaux à poisson

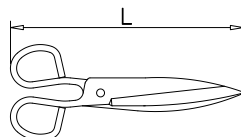

L	Gr	Barcode	€
180	115	446804	<b>6,00</b>
200	155	446806	<b>9,00</b>
220	200	446808	<b>6,50</b>
240	260	446810	<b>22,00</b>
260	340	446812	<b>26,00</b>
280	415	446814	<b>36,00</b>

## Tijera pescadero / cocina con protección

Kitchen / fish scissors with protection  
Ciseaux de poissonniers / de cuisine avec protection

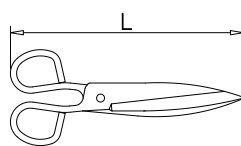

L	Gr	Barcode	€
210	260	446816	<b>4,50</b>

## Tijeras de trinchar

Chicken scissors  
Couteau à poulets

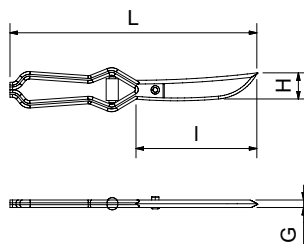

L	I	H	G	Gr	Barcode	€
260	125	20	10	270	446850	<b>18,00</b>

## Tijera desmontable multiusos

Detachable multi-purpose scissors  
Ciseaux multi-usages démontables

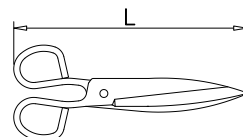

L	Gr	Barcode	€
200	160	446854	<b>31,00</b>

## Tijeras multiusos

Multi purpose scissors  
Ciseaux multi-usages

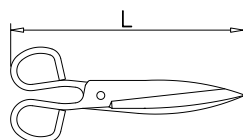

L	Gr	Barcode	€
215	160	446852	<b>20,00</b>

## Tijera profesional

Professional scissors  
Ciseaux professionnelles

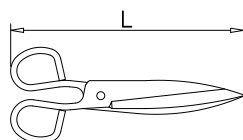

L	Gr	Barcode	€
210	290	446856	<b>44,50</b>
245	505	446858	<b>71,00</b>



## Afiladores Knife-sharpener Aiguiseur

AD

### Chairas Sharpening steel Fusil à affûter

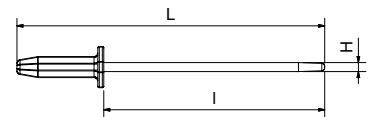

L	I	H		Gr			€
440	305	11		360		447202	<b>22,00</b>
430	305	10		340		447210	<b>26,00</b>
430	305	10		340		447212	<b>26,00</b>
440	305	20-10		380		447204	<b>28,00</b>

### Chaira cerámica Sharpening ceramic Fusil à aiguiser en céramique



Sus principales ventajas son su ligereza y una mayor vida útil frente al resto de chairas.

Fabricada con cerámica de alta y avanzada tecnología.

Recomendada para cuchillos fabricados con aceros y aleaciones especiales de cuchillería, como molibdeno-vanadio, CROMOVA 18, etc. No válida para cuchillos cerámicos.

Excelente resultado del afilado.

Its main advantages are its lightness and durability compared with other sharpeners.

Made of high and advanced technology ceramic.

Recommended for knives manufactured with steel and special alloys for knives, such as molybdenum-vanadium, CROMOVA 18, etc. It is not valid for ceramic knives.

Excellent sharpening results.

Ses principales avantages sont sa légèreté et de durabilité par rapport à d'autres taille.

Fabriqué en céramique de haute et avancée technologie.

Recommandé pour les couteaux fabriqués avec des aciers et alliages spéciaux, tels que le molybdène vanadium, CROMOVA 18, etc Il n'est pas valable pour les couteaux en céramique.

Excellente netteté des résultats.



L	I	H	Gr			€
380	245	14,00	160		447206	<b>30,00</b>

## Chaira diamantada

Diamond sharpening steel  
Fusil à aiguiser diamanté



Su principal ventaja es la posibilidad de afilar todo tipo de **cuchillos**, incluso los **cerámicos**.

La hoja de acero cubierta de diamante en polvo permite obtener un resultado particularmente fino de afilado. La capa de diamante se desgasta con el tiempo, acortando poco a poco la vida útil del utensilio. Se recomienda utilizarla complementariamente a la chaira de acero.

El mango inyectado en polipropileno proporciona gran ergonomía a la vez que firmeza en la sujeción, con diseño protector y anilla para colgar.

Ses principales avantages est la possibilité d'affûter tous les types de **couteaux**, même les **céramiques**.

La lame en acier recouvert de poudre de diamant à la suite d'un aiguisage de la lame particulièrement fin. La couche de diamant s'use au fil du temps, le raccourcissant progressivement la durée de vie de l'outil. Il est recommandé de l'utiliser en alternance avec le fusil à aiguiser en acier.

La poignée en polypropylène injecté offre une grande ergonomie avec fermeté à saisir et une conception de protection. Fourni avec anneau de suspension.

Its main advantage is the possibility of sharpening all kind of **knives**, even the **ceramic** ones.

The steel blade covered with diamond powder has as a result a especially fine blade sharpening. The diamond layer wears out over time, shortening gradually the life of the tool. It is recommended to use it alternatively with the steel sharpener.

The injected polypropylene handle offers a great ergonomics together with firmness in gripping, a protective design. Provided with hanging ring.



L	I	H	Gr		€
440	305	20>10	295	447208	<b>25,00</b>

## Piedra de afilar de mano

Hand sharpening stone  
Pierre à aiguiser manuelle

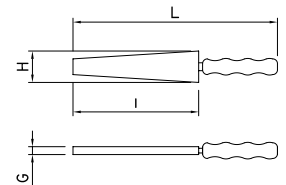

L	I	H	G	Gr	€
240	120	40	15	123	<b>4,50</b>

## Piedra para afilar cuchillos al agua 240/320

Water grindstone 240/320 for knives  
Pierre à aiguiser à base d'eau 240/320

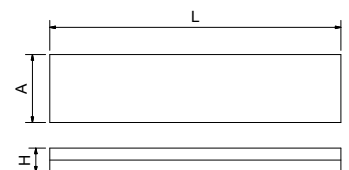

L	A	H	Gr	€
200	50	25	480	<b>6,00</b>

## Afilador cuchillos manual de sobremesa

Manual knife-sharpener for worktop  
Aiguseur manuel sur table

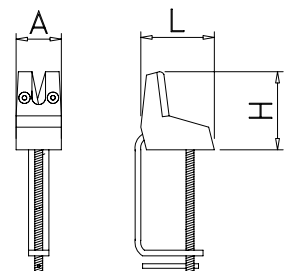

L	A	H	Gr	€
60	66	40	380	<b>124,00</b>

### Cuchillas de repuesto para afilador 448304

Spare blades for knife-sharpener 448304  
Lames de rechange pour l'affûteur 448304

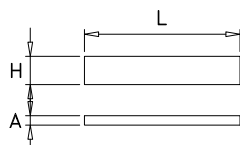

Juego de 4 cuchillas, 2 gomas protectoras grandes (63x48 mm.) y 1 goma protectora pequeña (45x20 mm.)  
Set of 4 blades, 2 large protective rubbers (63x48 mm) and 1 small protective rubber (45x20 mm.)  
Ensemble de 4 lames, 2 caoutchoucs de protection grandes (63x48 mm.) et un caoutchouc de protection petite (45x20 mm.)

L	A	H	Gr	€
33	2	6	33	<b>448354 66,00</b>



### Afilador de cuchillos manual de sobremesa

Manual knife-sharpener for worktop  
Aigiseur de Couteaux manuel sur table

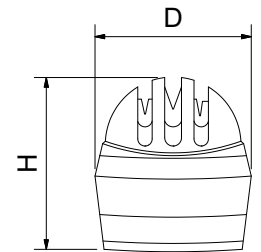

H	D	Gr	Barcode	€
70	65	120	448302	<b>11,00</b>

### Afilador de cuchillos manual de sobremesa

Manual knife-sharpener for worktop  
Aigiseur de couteau manuel sur table

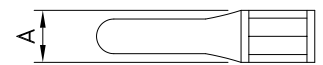
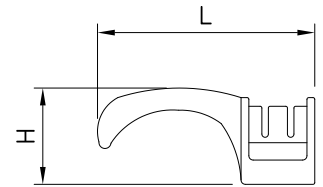

L	A	H	Gr	Barcode	€
210	60	78	200	448310	<b>8,00</b>

### Afilador de cuchillos eléctrico mini

Mini electric knife sharpener  
Mini affûteur électrique

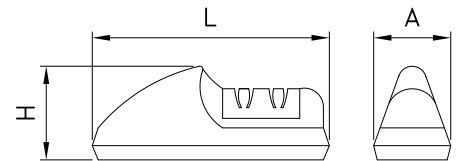

L	A	H	Gr	Barcode	€
190	65	80	340	448314	<b>46,00</b>

### Afilador de cuchillos profesional

Professional knife-sharpener  
Aigiseur professionnel



Mas información en fricosmos.com  
More info in fricosmos.com  
Plus d'informations sur fricosmos.com

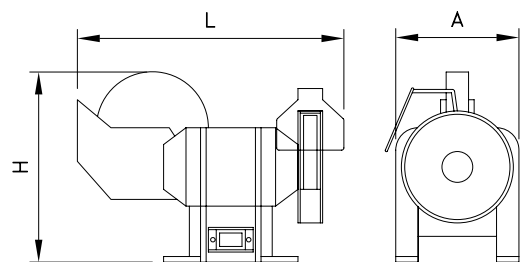

L	A	H	Potencia Power Puissance	Tensión Voltage Tension	Frecuencia Frequency Fréquence	Kg	Barcode	€
415	260	245	270 W	220 V	50 Hz	12	448306	<b>135,00</b>

D	G	Gr	Barcode	€
---	---	----	---------	---

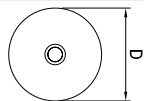

Repuesto de muela (grano 60) para afilador 448306  
Spare grindstone (grit 60) for knife-sharpener 448306  
Meule de rechange( grain 60) pour affûteur 448306

150 150 150 448350 **54,00**

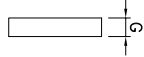

Repuesto de muela abrasiva (grano 120) para afilador 448306  
Spare grindstone (grit 120) for knife-sharpener 448306  
Meule de rechange( grain 120) pour affûteur 448306

200 40 400 448352 **150,00**



## Portacuchillos Mounted knife Porte-couteaux

### Portacuchillos para adosar con envoltente Mounted knife holder with wrapping Porte-couteaux pour adosar avec enveloppant



Cuchillero con alojamiento especial para tijeras y chairas.

Knife-holder with special lodging for scissors and sharpeners.

Porte-couteaux avec logement spécial pour ciseaux et fusils à affûter.

⚠ **Capacidad: 18 cuchillos**  
Capacity: 18 Knives  
Capacité: 18 couteaux

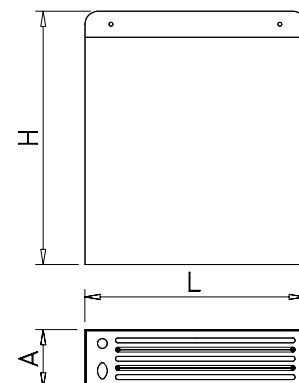

Acoplar portacuchillos  
Assembly knife holder  
Assembler porte-couteaux

€

**28,00**



Este precio no incluye el portacuchillos  
Knife-holder not included in this price  
Porte-couteaux n'inclus pas dans ce prix

L	A	H	Kg	Barcode	€
380	90	420	3,75	040602	<b>86,00</b>

### Portacuchillos portátil Portable knives holder Porte couteaux transportable

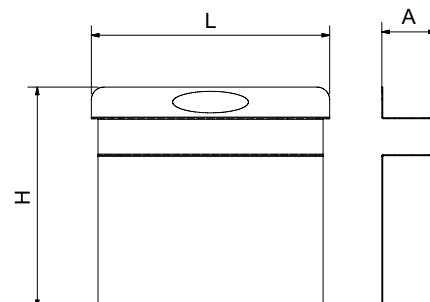

⚠ **Capacidad: 20 cuchillos**  
Capacity: 20 Knives  
Capacité: 20 couteaux

L	H	A	Kg	Barcode	€
377	350	86	2,40	041050	<b>55,00</b>

### Contenedor para transporte de cuchillos

Container for knives transport  
Conteneur pour déplacer les couteaux



431518 90,00

Repuesto fibra  
Spare fibre  
Plaque de rechange

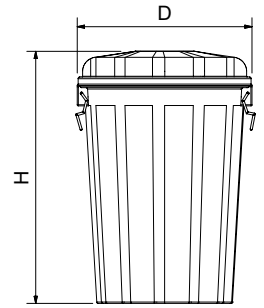
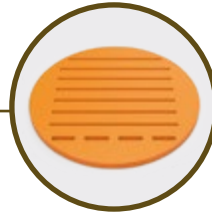

H	D	Kg	Barcode	€
730	495	8,5	041062	112,00

### Contenedor para transporte de cuchillos con ruedas

Container for knives transport with wheels  
Conteneur pour déplacer les couteaux avec des roues



431516 59,00

Repuesto fibra  
Spare fibre  
Plaque de rechange

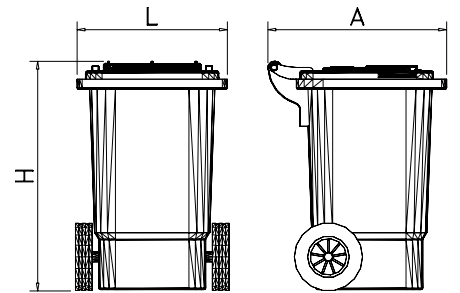

L	A	H	Kg	Barcode	€
470	550	670	11,00	041060	128,00

### Portacuchillos con doble alojamiento de sobremesa

Worktop knife holder with dual housing  
Porte-couteaux avec deux logements pour placer sur table



Capacidad: 20 cuchillos  
Capacity: 20 Knives  
Capacité: 20 couteaux

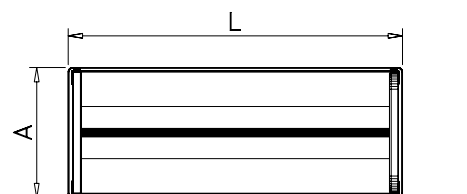
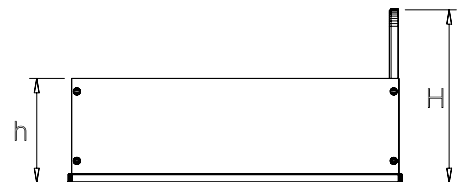

L	A	h	H	Kg	Barcode	€
435	165	140	200	3,73	041202	123,00

Construido en acero inoxidable y polietileno calidad P-500.  
Constructed in stainless steel and P-500 quality polyethylene.  
Fait en acier inoxydable et polyéthylène qualité P-500.

### Portacuchillos para adosar en varilla

Rod mounted knife holders  
Porte-couteaux pour adosar sur tringle



Acoplar portacuchillos  
Assembly knife holder  
Assembler porte-couteaux

€  
**28,00**



Este precio no incluye el portacuchillos.  
Knife-holder not included in this price.  
Porte-couteaux n'inclus pas dans ce prix.

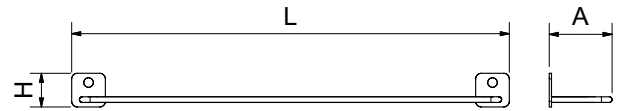

L	H	A	Gr	Barcode	€
340	30	51	270	040802	<b>43,00</b>
390	30	51	300	040804	<b>46,00</b>
440	30	51	330	040806	<b>48,00</b>

### Portacuchillos para adosar en chapa

Plated knife holders for mounting  
Porte-couteaux plaqué pour adosar



Cuchillero con alojamiento especial para tijeras y chairas.

Knife-holder with special lodging for scissors and sharpeners.

Porte-couteaux avec logement spécial pour ciseaux et fusils à affûter.



Capacidad: 18 cuchillos  
Capacity: 18 Knives  
Capacité: 18 couteaux

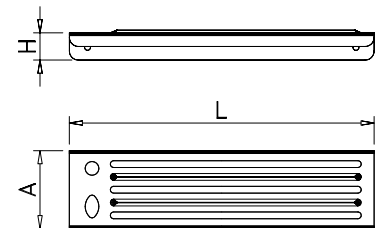

Acoplar portacuchillos  
Assembly knife holder  
Assembler porte-couteaux

€  
**28,00**



Este precio no incluye el portacuchillos.  
Knife-holder not included in this price  
Porte-couteaux n'inclus pas dans ce prix

L	A	H	Gr	Barcode	€
380	90	30	600	041002	<b>24,00</b>
450	90	30	730	041004	<b>28,00</b>

### Portacuchillos mural imantado

Magnetic wall knife holder  
Porte-couteaux de mur magnétique



L	A	H	Gr	Barcode	€
330	15	46	200	448472	<b>10,00</b>

### Portacuchillos mural imantado de acero inoxidable

Magnetic knife-holder in stainless steel  
Porte-couteaux magnétique en acier inoxydable

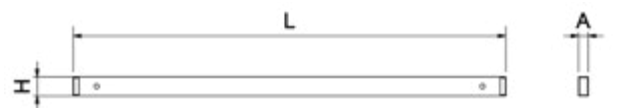

L	H	A	Gr	Barcode	€
456	20	10	500	041602	<b>53,00</b>



**Menaje**  
Kitchenware  
Ustensiles de cuisine

**Pinza para frituras**  
Frying tongs  
Pince à friture

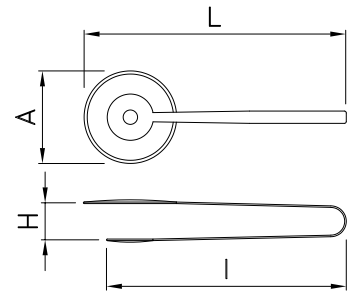

L	I	A	H	Gr	Barcode	€
280	250	100	90	310	440006	5,00

**Pinza de servir**  
Serving tongs  
Pincas à servir

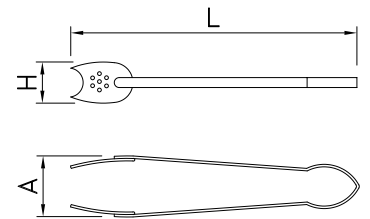

L	A	H	Gr	Barcode	€
230	45	32	200	440002	6,50

**Pinza para servir espaguetis acero inox**  
Stainless steel spaghetti serving tongs  
Pince à servir les spaghettis en acier inoxydable

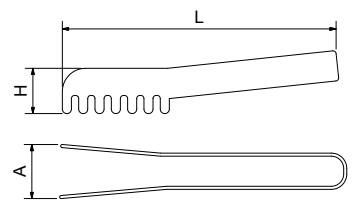

L	A	H	Gr	Barcode	€
190	50	35	60	440094	5,00

**Pinza para barbacoa**  
Barbecue tongs  
Pince de barbecue

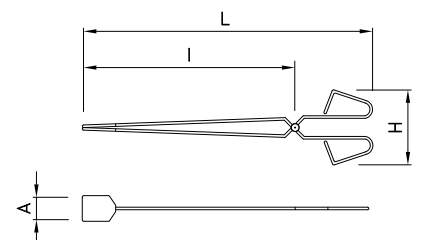

L	I	A	H	Gr	Barcode	€
400	300	45	90	250	440004	6,50

**Paleta**  
Slotted turner  
Pelle

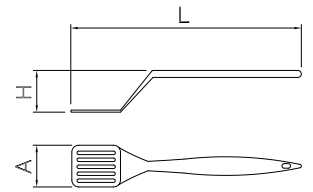

L	A	H	Gr	Barcode	€
330	70	60	170	440038	<b>3,00</b>

**Espátulas**  
Spatula  
Spatules

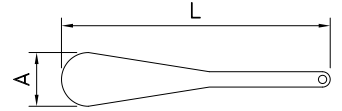

L	A	Gr	Barcode	€
250	50	39	483220	<b>3,50</b>
300	60	65	483222	<b>6,00</b>
350	70	93	483224	<b>5,50</b>
400	80	112	483226	<b>9,50</b>
500	90	184	483228	<b>12,50</b>



Ver pag. 438  
See page 438  
Voir page 438

**Cazo**  
Ladle  
Louche

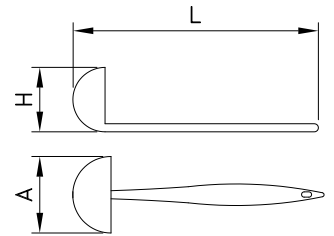

L	A	H	Gr	Barcode	€
305	85	80	200	440032	<b>3,00</b>

**Cucharón de servir**  
Serving spoon  
Cuillère à servir

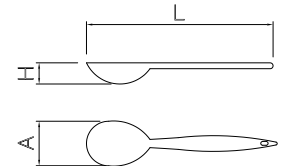

L	A	H	Gr	Barcode	€
340	65	15	150	440034	<b>3,00</b>

**Espumadera**  
Slotted spoon  
Écumoire

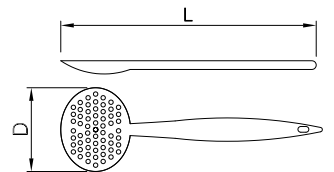

L	D	Gr	Barcode	€
320	100	180	440036	<b>3,00</b>

**Espumadera inoxidable con mango de plástico**  
Stainless steel skimmer with plastic handle  
Écumoire en acier inoxydable avec manche en plastique

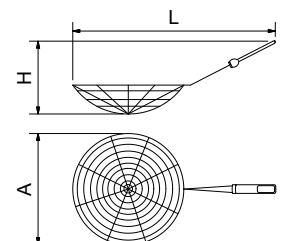

L	D	H	Gr	Barcode	€
350	190	35	180	440037	<b>3,00</b>



**Batidor**  
Whisk  
Fouet

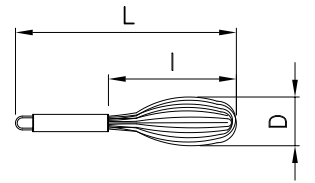
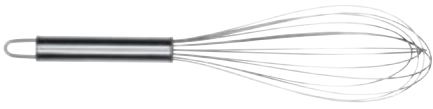

L	I	D	Gr	Barcode	€
270	160	60	180	440014	<b>3,00</b>

**Espumador eléctrico manual mini con soporte**  
Mini electric frother with stand  
Mini mousseur électrique manuel avec support



**N**ovedad  
NEW  
NOUVEAU

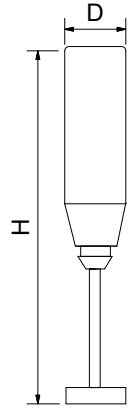

D	H	Gr	Barcode	€
35	224	120	480246	<b>8,50</b>

**Mortero de acero inox**  
Stainless steel mortar  
Mortier en acier inoxydable

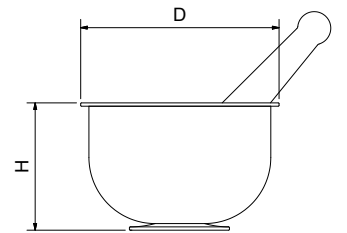

D	H	Gr	Barcode	€
120	80	300	440096	<b>29,00</b>

**Colador**  
Colander  
Passoir

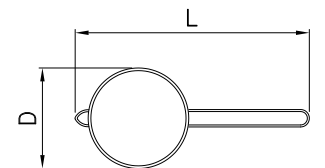

L	D	Gr	Barcode	€
375	185	180	440011	<b>8,00</b>

**Colador/Tamizador**  
Colander/Chinese strainer  
Passoire/Chinois étamine inox

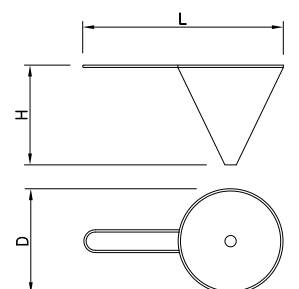

L	D	H	Gr	Barcode	€
350	180	130	400	440010	<b>8,00</b>

### Mazo para chino

Tool for strainer  
Outil pour chinois étamine

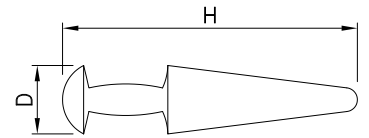

D	H	Gr	Barcode	€
65	280	400	434460	<b>55,00</b>

### Escurreidor de verduras

Vegetable drainer  
Egouttoir légumes

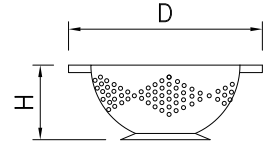

D	H	Gr	Barcode	€
305	100	250	440060	<b>10,50</b>

### Escurreidor de ollas regulable

Multi-colander  
Passoire multiple



Características:  
Acoplable a varios diámetros.

Characteristics:  
Coupled with various diameter.

Caractéristiques:  
Adaptables à différents diamètre.

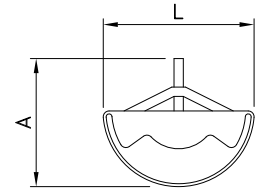

L	A	Gr	Barcode	€
230	220	110	440072	<b>9,50</b>

### Volteadora inox de tortilla

Stainless steel turner lid for omelettes  
Couvercle retourne-omelette inox

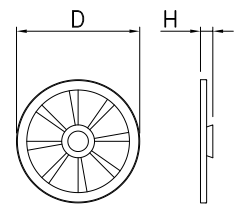

D	H	Gr	Barcode	€
300	15	250	440910	<b>9,00</b>

### Librador

Scoop  
Cornet

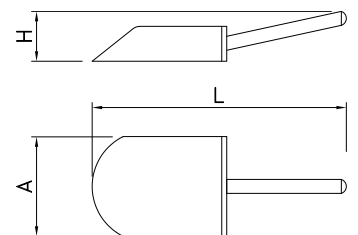

L	A	H	l	h	Gr	Barcode	€
235	75	85	120	30	150	440074	<b>10,00</b>
280	100	100	160	40	170	440076	<b>12,00</b>
300	135	110	200	60	200	440078	<b>15,00</b>



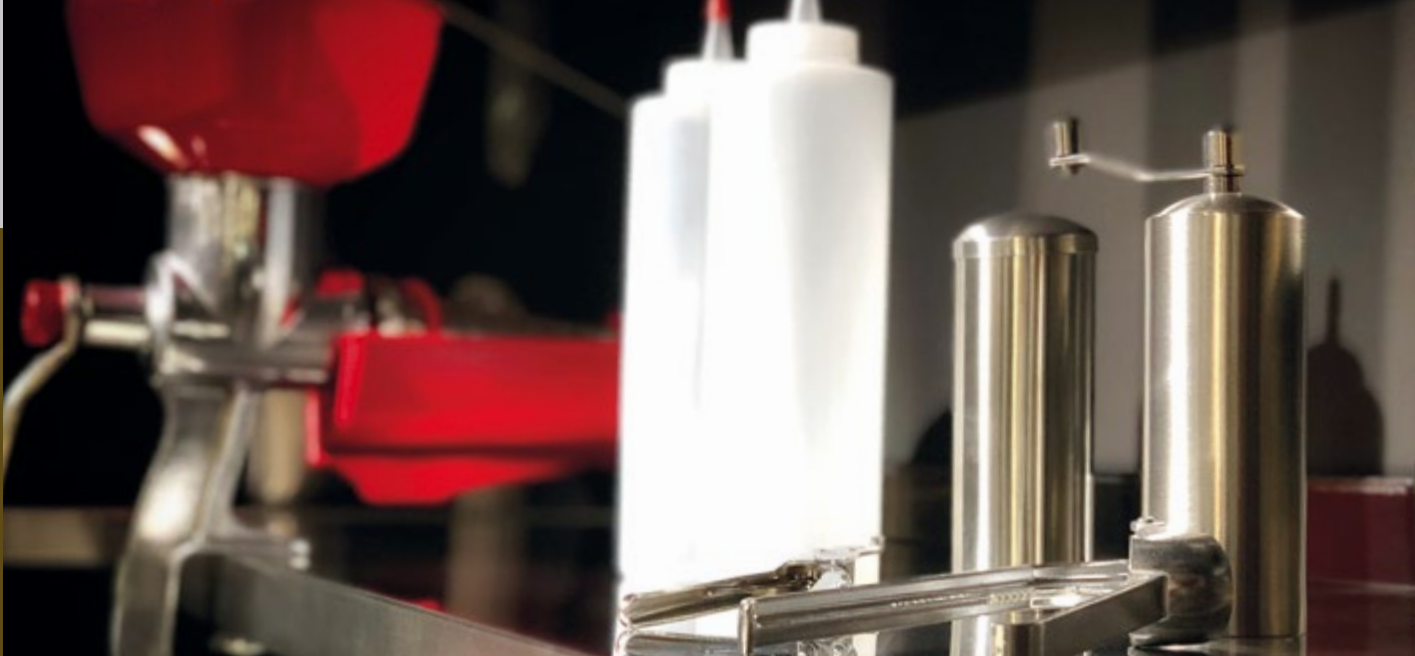

AD



## Utensilios de cocina

Cooking utensils  
Ustensiles de cuisine

### Pelador de cerámica

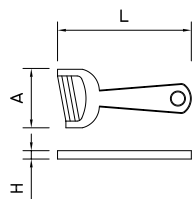
Ceramic peeler  
Couteau éplucheur en céramique



	L	A	H	Gr	Barcode	€
	120	50	20	75	446122	<b>4,50</b>
	140	80	30	27,2	446124	<b>6,50</b>

### Abrelatas tenaza

Can opener  
Ouvre-boîte

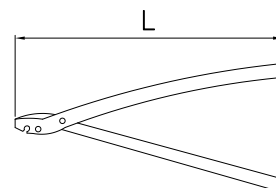

L	Gr	Barcode	€
150	125	440020	<b>5,00</b>

### Abrelatas

Can opener  
Ouvre-boîtes

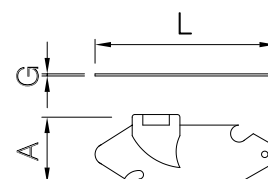

L	A	G	Gr	Barcode	€
80	30	2	50	440019	<b>2,00</b>

## Abrelatas industrial

Industrial can opener  
Ouvre-boîtes industriel

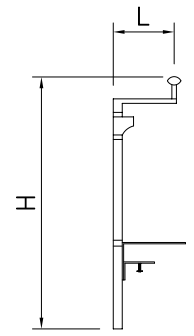

L	H	Kg	Barcode	€
150	550	1,80	440021	<b>116,00</b>



### Repuesto roldana para abrelatas industrial 440021

Spare cog for commercial can opener 440021

Pièce de rechange, engrenage pour ouvre-boîte industriel 440021

Gr	Barcode	€
35	440090	<b>21,00</b>

### Repuesto cuchilla para abrelatas industrial 440021

Spare blade for commercial can opener 440021

Pièce de rechange, lame pour ouvre-boîte industriel 440021

Gr	Barcode	€
7	440092	<b>20,00</b>

## Conjunto de 6 aros de emplatar en acero inox

Rings mold set in stainless steel - 6 pieces

Set de 6 moules à dresser en acier inox

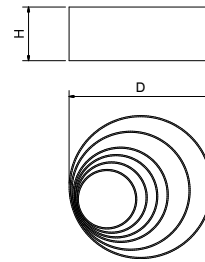

D	H	Gr	Barcode	€
60				
80	45	160	440064	<b>5,00</b>
100				

## Conjunto aros de emplatar

Ring mold set

Set de moules

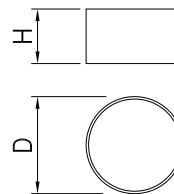

D	H	Gr	Barcode	€
60	45	150		
80	45	150	434472	<b>13,00</b>

## Moldes cuadrados

Square pastry mould

Cercle carre pour patisserie

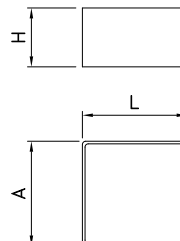

L	A	H	Gr	Barcode	€
60	60	45	60	440080	<b>3,50</b>
70	70	45	70	440082	<b>3,60</b>
80	80	45	90	440084	<b>3,70</b>
90	90	45	100	440086	<b>3,80</b>
100	100	45	110	440088	<b>3,90</b>

## Set de 4 flaneras de ø8 cm

4 flan mould set ø8 cm

Lot de 4 moules à flan ø8 cm

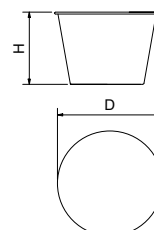

D	H	Gr	Barcode	€
80	55	120	440328	<b>4,00</b>



**Enrollador de maki super-higiénico**  
Sushi rolling mat, ultra-hygienic  
Enrouleur de maki super-hygiénique

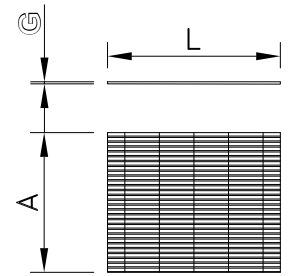

L	A	G	Gr	Barcode	€
250	165	3	110	434486	<b>30,00</b>
250	240	3	160	434488	<b>35,00</b>
250	305	3	200	434490	<b>45,00</b>

**Especiero inox con tres niveles**  
Spice rack three levels  
Armoire à épices

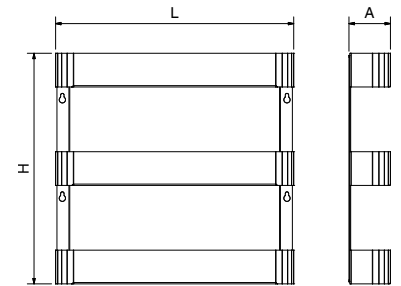

L	A	H	Kg	Barcode	€
353	61	342	1,4	040204	<b>56,00</b>

**Estante especiero**  
Spices and oils rack  
Étagère pour épices

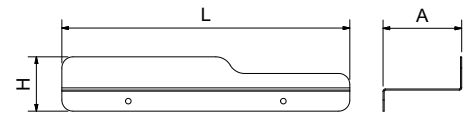

L	A	H	Gr	Barcode	€
260	71	49	231	040206	<b>16,00</b>

**Escurreidor mural para utensilios de cocina**  
Wall drainer for kitchen utensils  
Egouttoir mural pour ustensiles de cuisine



L	A	H	Kg	Barcode	€
400	365	100	2,4	042602	<b>50,00</b>

**Escurreidor de platos y vasos en acero inoxidable**  
 Stainless steel drainer for glasses and dishes  
 Egouttoir en acier inoxydable pour assiettes et verres

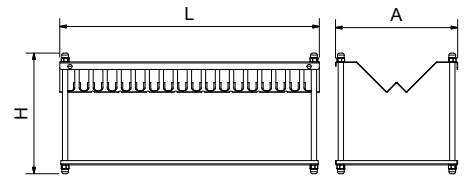

L	A	H		Kg		€
484	228	225	18	1,78	051602	<b>48,00</b>
955	228	225	36	3,25	051604	<b>75,00</b>

**Molinillo de hierbas**  
 Herb mill  
 Moulin à herbes

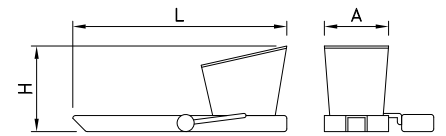

L	A	H	Gr		€
200	60	80	110	440902	<b>10,50</b>

**Rallador de queso**  
 Cheese grater  
 Râpe à fromage

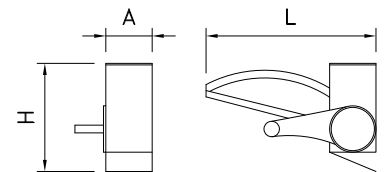

L	A	H	Kg		€
230	100	80	1,37	447914	<b>12,00</b>

**Prensa ajos**  
 Garlic press  
 Presse-ail

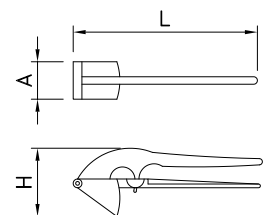

L	A	H	Gr		€
200	22	90	270	440042	<b>7,00</b>

**Molinillo 2 en 1 sal y pimienta**  
 Two-in-one salt and pepper grinder  
 Moulin à sel et poivre 2 en 1

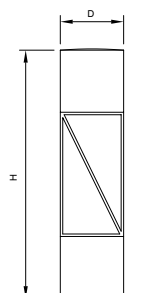

D	H	Gr		€
51	200	300	440046	<b>20,00</b>

**Rallador inox**  
Stainless steel grater  
Râpes inox

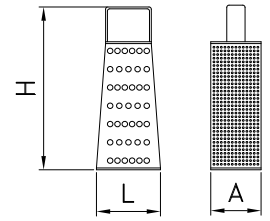

L	A	H	Gr	Barcode	€
90	60	170	100	447916	5,00

**Molinillo juliana**  
Julienne mill  
Moulin julienne

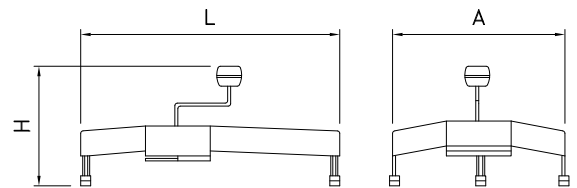

Incluye 5 discos  
5 discs included  
5 disques inclus

L	A	H	Gr	Barcode	€
180	260	60	800	440904	27,50

**Pasapuré profesional**  
Professional food mill  
Presse-purée professionnel

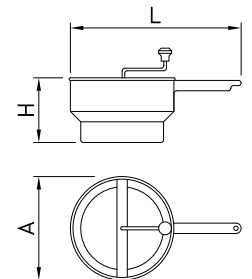

Incluye 3 discos  
3 discs included  
3 disques inclus

L	A	H	Gr	Barcode	€
350	254	170	570	440906	15,00

**Picador de tomate**  
Tomato squeezer  
Presse tomates

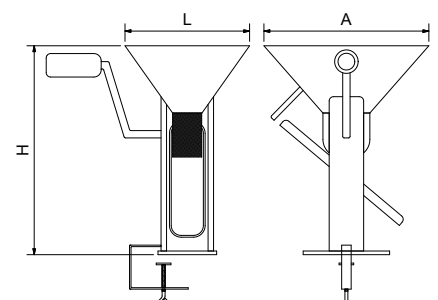

L	A	H	Kg	Barcode	€
170	225	300	1,38	447904	44,00

## Mandolina para cortar / laminar trufas en acero inoxidable

Truffle slicer in stainless Steel

Mandoline en acier inoxydable pour couper - laminer des truffes



**N**ovedad  
NEW  
DESIGN

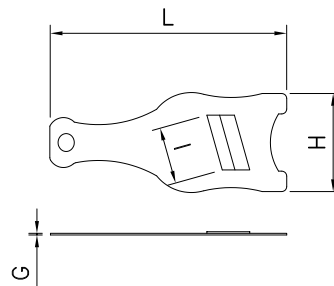

L	I	H	G	Gr	Barcode	€
200	60	85	1,2	115	440918	<b>32,00</b>

## Triturador de hielo

Ice crusher

Broyeur à glace

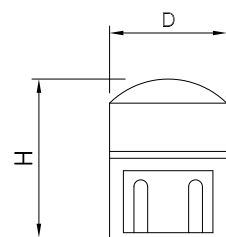

D	H	Gr	Barcode	€
150	260	700	447902	<b>29,50</b>

## Cortadora de fiambres manual

Cold meat cutter

Trancheuse de charcuterie



### Características:

Construida en acero inoxidable.

Diámetro del disco-cuchilla  $\varnothing$ 120mm

Desplazamiento de carro progresivo con un mango tipo ruleta que regula la anchura de corte.

### Characteristics:

Made of stainless steel

Blade disc diameter  $\varnothing$ 120mm

Progressive cutting carriage displacement, by a spinning handle for cutting adjustment

### Caractéristiques:

Fabriquée en acier inoxydable.  
Diamètre de la lame disque  $\varnothing$ 120mm

Déplacement progressif du chariot avec une poignée roulette qui règle la largeur de coupe.

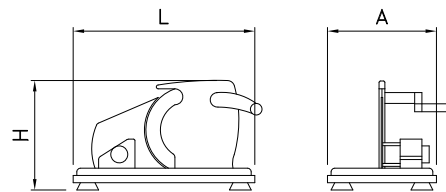

L	A	H	kg	Barcode	€
250	145	160	1,00	447906	<b>81,50</b>

## Punzonador de embutidos

Sausage punch

Outil perce-saucisse

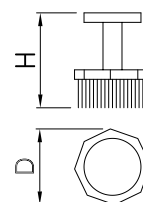

D	H	Gr	Barcode	€
40	50	50	440028	<b>12,50</b>

**Embudo**  
Funnel  
Entonnoir

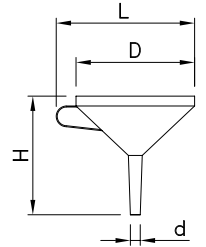

L	D	H	d	Gr	Barcode	€
170	140	135	17	150	440012	<b>10,50</b>

**Biberones de cocina**  
A squeeze bottle  
Biberons de cuisine

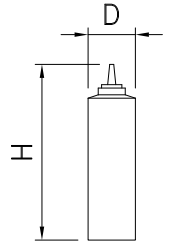

D	H	ml	Gr	Barcode	€
50	190	250 ml	33	440912	<b>2,00</b>
60	230	500 ml	50	440913	<b>2,50</b>

**Dispensador de salsa con dosificador**  
Sauce dispenser with pump  
Distributeur de sauce avec doseur

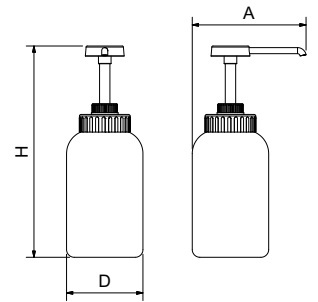

A	H	D	Color	Quantity	Kg	Barcode	€
151	275	99		1	0,12	487298	<b>23,00</b>
							487296
							487299

**Conjunto dispensador de 3 salsas con dosificadores y soporte**  
3 sauces dispenser set with stand support  
Ensemble de 3 distributeurs de sauces avec doseurs et support

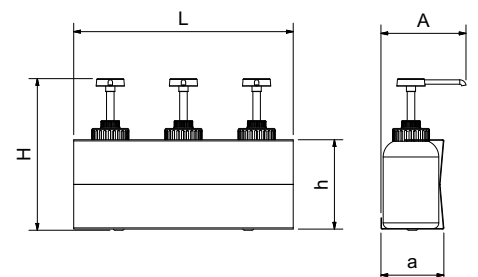

L	A	H	a	h	Kg	Barcode	€
390	155	276	112	159	1,40	040242	<b>143,00</b>

### Soporte organizador de acero inoxidable para 3 salsas

Stainless steel organizer rack for 3 sauce bottles

Support organisateur en acier inoxydable pour 3 sauces



**N**ovedad  
ew  
nouveauté

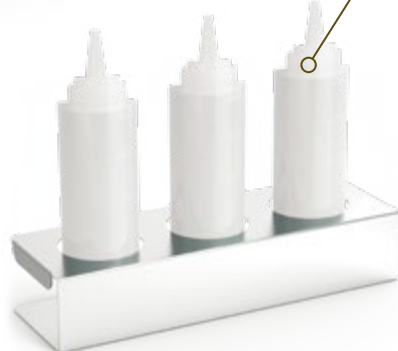

149

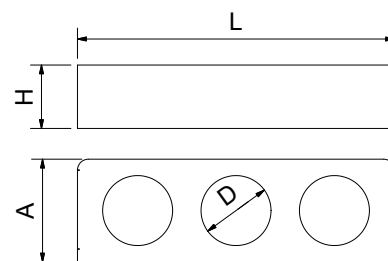

L	A	H	D	Gr	Barcode	€
290	94	58	64	400	040244	<b>14,00</b>

### Dosificador de salsas y recipiente inox

Container and pump-dispenser for sauce

Distributeur-doseur de sauces et récipient inoxydable



Bomba de 5 cc.  
Cierre a presión.  
Contenedor inox.con tapa plástica transparente.

Colored pumps 5 cc.  
Snap closing.  
Inox container with transparent plastic lid.

Pompe de 5 cc.  
Fermeture à pression.  
Récipient inox avec couvercle en plastique transparent.

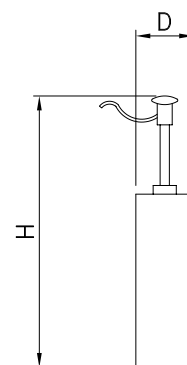

D	A	H	Gr	Barcode	€
				487283	
80	110	220	0,5 lts	400	<b>76,00</b>
				487294	

### Pala inoxidable para patatas fritas con dos asas

Stainless steel shovel with two handles, for french fries

Pelle en acier inoxydable à frites, à double poignée



**N**ovedad  
ew  
nouveauté

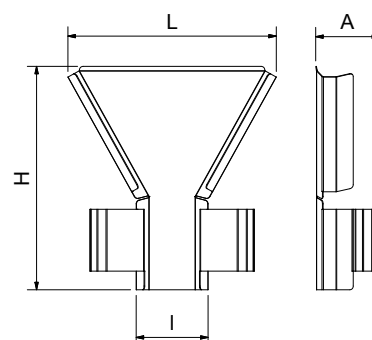

L	I	A	H	Gr	Barcode	€
224	77	69	240	400	040218	<b>18,00</b>



### Dosificador de salsas - 30 ml.

Sauces dispenser - 30 ml.  
Distributeur de sauces - 30 ml.



Concepto Concept Concept		€
Taladro Drill hole Tariere	082808	4,00

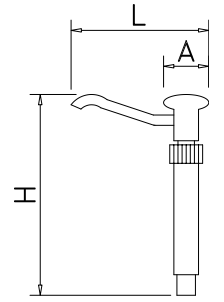

L	A	H	Gr		€
130	40	270	50	487278	20,00

### Balanza mecánica de cocina

Kitchen scales  
Balance mécanique de cuisine



Características:  
Capacidad: 5 Kg.  
Divisiones de 20 en 20 gramos.  
Sensibilidad: 20 gramos.

Characteristics:  
Capacity: 5 kg.  
Divisions every 20 gr.  
Accuracy: 20 gr.

Caractéristiques:  
Capacité : 5 Kg.  
Divisions de 20 en 20 grammes.  
Sensibilité : 20 grammes.

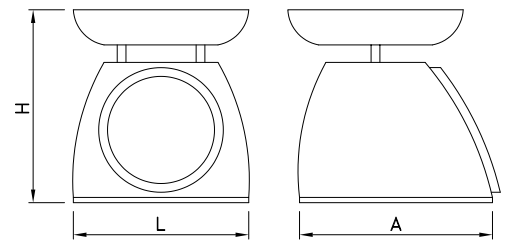

L	A	H	Kg		€
220	200	220	1,80	480234	58,00

### Balanza de cocina digital 5 kg

Digital kitchen scale 5 kg  
Balance de cuisine numérique 5 kg



Características:  
Capacidad máxima 5kg  
Sensibilidad 1gr  
Unidades de medida: gr, oz, lb, ml  
Indicador de pila baja y sobrecarga  
Función de tara  
Auto-apagado

Caractéristiques:  
Capacité 5kg  
Sensibilité 1gr  
Unités de mesure: gr, lb, oz, ml  
Indicateur de pile basse et de surcharge  
Fonction de tare  
Arrêt automatique

Characteristics:  
Max. Capacity 5kg  
Accuracy 1gr  
Units of measurement: gr, lb, oz, ml  
Low battery and overload indicators  
Tare function  
Auto power-off

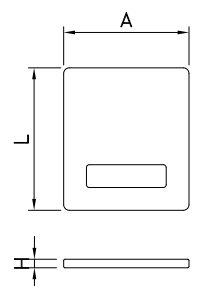

L	A	H	Gr		€
180	140	18	500	480232	24,00

## Balanza digital de precisión 1kg

Precision digital scale 1kg  
Balance digitale de précision 1kg



Características:  
Capacidad: 1 Kg.  
Sensibilidad: 0,2 grs.  
Función tara.  
Unidades de medida: gr, oz.

Characteristics:  
Capacity: 1 kg.  
Accuracy: 0,2 grs.  
Tare function.  
Units of measurement: gr, oz.

Caractéristiques:  
Capacité: 1 Kg.  
Sensibilité : 0,2 grs.  
Fonction de tare  
Unités de mesure: gr, oz.

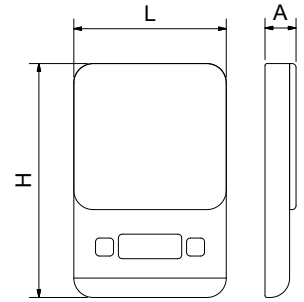

L	A	H	Gr	480233	€
113	24	181	230	480233	40,00

## Rasqueta para vitrocerámicas

Scraper for glass ceramic  
Grattoir pour vitrocéramique

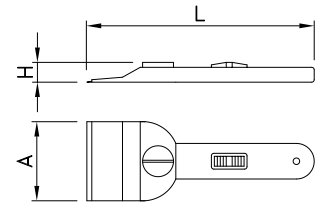

L	A	H	Gr	448110	€
135	45	18	100	448110	4,00

## Espátula para planchas de cromo-duro

Spatula for chromium plate griddles  
Raclor pour plaques chromées

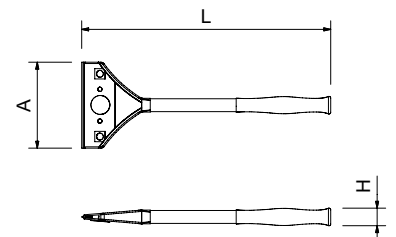

L	A	H	Gr	448102	€
290	100	20	348	448102	39,00



Hojas de repuesto en acero inoxidable para espátula plancha de cromoduro.

Stainless steel spare blades for chromium plate griddle spatula.  
Lames de rechange pour raclor à plaque chromée.



10 50 448104 25,00



AD

## Utensilios para pizzería

Pizza making utensils  
Ustensiles pour pizzeria

### Picador de masa de pizza en acero inox

Pizza dough pitter in stainless steel  
Pique pâte à pizza en acier inox

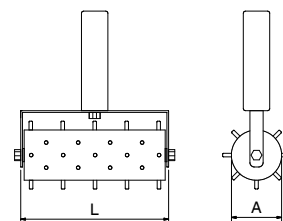

L	A	Gr	Barcode	€
127	44	350	440706	47,00

### Pinza para bandeja de horno en acero inox

Clip for baking tray in stainless steel  
Pincas pour plaque à four en acier inox



L	A	Gr	Barcode	€
190	30	100	440714	10,50

### Cazo para salsa en acero inox

Saucepan in stainless steel  
Cuillère à sauce en acier inox

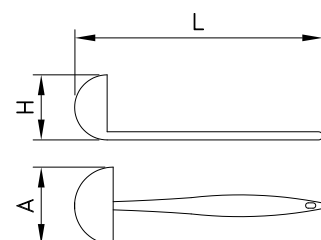

L	A	H	Gr	Barcode	€
370	90	90	170	440712	16,50

**Rasqueta cortadora de masa en acero inoxidable**  
 Stainless steel dough cutter/scrapper  
 Racloir à pâte en acier inoxydable

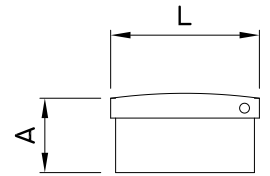

L	A	Gr	Barcode	€
150	75	180	440748	14,00

**Cortadora de masa de pizza**  
 Pizza dough cutter  
 Coupe pâte à pizza

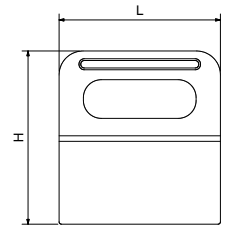

L	H	Gr	Barcode	€
135	145	100	440722	16,50

**Rejilla de aluminio para hornear pizza**  
 Aluminum baking rack for pizza  
 Grille à pizza en aluminium

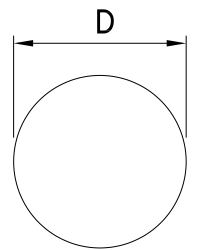

D	Gr	Barcode	€
370	150	440750	18,00

**Bandeja de aluminio con asas para pizza 6 porciones**  
 Pizza aluminium tray with handgrips - 6 slices  
 Plaque en aluminium avec poignées pour pizza 6 portions

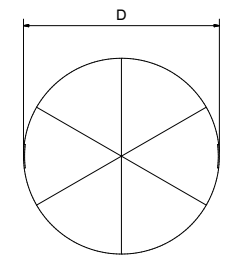

D	Gr	Barcode	€
450	300	440708	50,00

**Bandeja de aluminio con mango para pizza 6 porciones**  
 Pizza aluminium tray with handle - 6 slices  
 Plaque en aluminium avec manche pour pizza 6 portions

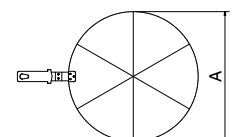
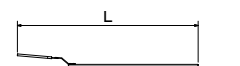
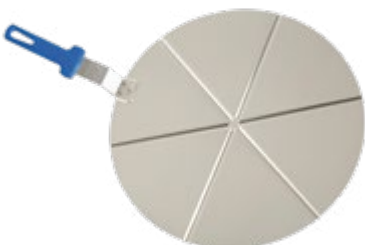

L	A	Gr	Barcode	€
660	450	320	440710	70,00

**Pala redonda de aluminio para horno**  
 Rounded tray baking peel in aluminium  
 Pelle ronde en aluminium pour four

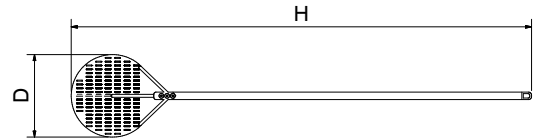

D	H	Gr	Barcode	€
330	1860	880	440702	120,00

**Pala para pizza**  
 Pizza oven peel  
 Pelle à pizza



**N**ovedad  
 ew  
 r  
 u  
 v  
 e  
 a  
 b  
 l

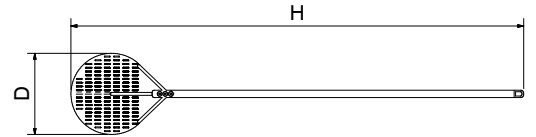

D	H	Gr	Barcode	€
220	1.740	770	440746	97,50

**Pala cuadrada de aluminio para horno**  
 Squared tray baking peel in aluminium  
 Pelle carrée en aluminium pour four

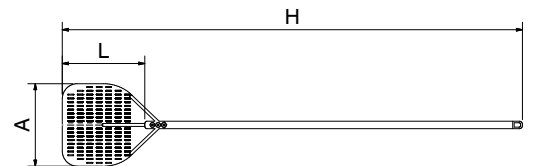

L	A	H	Gr	Barcode	€
330	330	1860	900	440704	120,00

**Paleta oval en acero inox**  
 Oval serving spatula in stainless steel  
 Pelle ovale en acier inox



Resistencia hasta 200° C  
 Heat resistance up to 200° C  
 Résistance jusqu'à 200° C

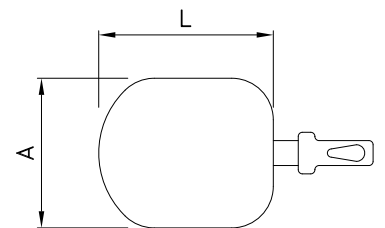

L	A	Gr	Barcode	€
210	180	500	440728	40,00

**Paleta oval en acero inox perforada**  
 Oval perforated serving spatula in stainless steel  
 Pelle ovale perforé en acier inox



Resistencia hasta 200° C  
 Heat resistance up to 200° C  
 Résistance jusqu'à 200° C

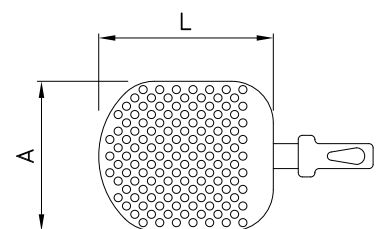

L	A	Gr	Barcode	€
220	180	500	440730	47,00

**Paleta redonda aluminio**  
 Rounded tray baking peel in aluminium  
 Pelle ronde en aluminium pour four



Resistencia hasta 200° C  
 Heat resistance up to 200° C  
 Résistance jusqu'à 200° C

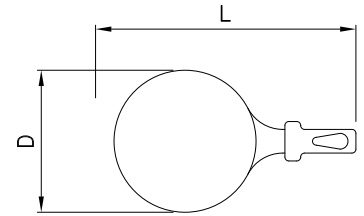

L	D	Gr	Barcode	€
430	280	350	440732	42,00

**Cortador de pizza**  
 Pizza cutter  
 Couteau à pizza

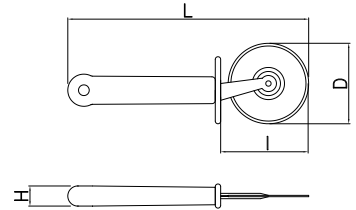

L	H	I	D	Gr	Barcode	€
205	20	90	65	66	446908	3,00

**Cortador de pizza profesional**  
 Professional pizza cutter  
 Coupe pizza professionnel

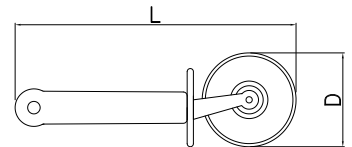

L	D	Gr	Barcode	€
245	100	150	440716	9,50

**Paleta para servir pizza en acero inox**  
 Pizza server in stainless steel  
 Pelle pour servir pizza en acier inox

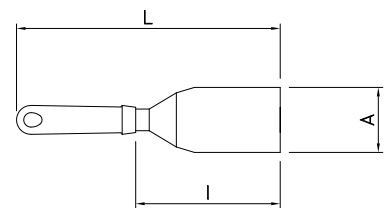

L	A	I	Gr	Barcode	€
250	70	100	140	440718	12,50

**Espátula para preparación pizza en acero inox**  
 Spatula for pizza in stainless steel  
 Spatule de préparation pizza en acier inox

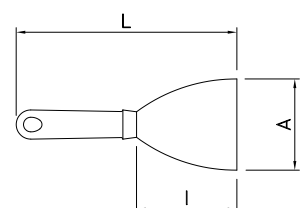

L	A	I	Gr	Barcode	€
240	100	125	150	440720	10,00

**Bolsa térmica para transporte de pizza**  
 Insulated thermal pizza delivery bag  
 Sac thermique pour transporter des pizzas

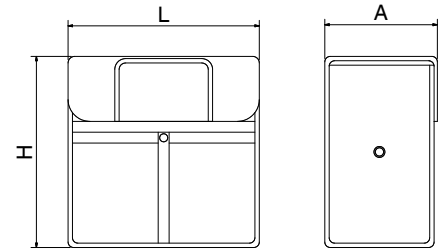

L	A	H	Gr	Barcode	€
440	290	450	4	700	440726 88,00

**Bases inoxidables para transporte de pizzas**  
 Stainless pizza pans  
 Base inox pour transport de pizzas

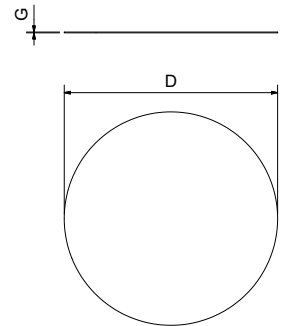

D	G	Kg	Barcode	€
278	1	0,49	042402	11,00
406	1	1,04	042404	16,00

**Cepillo de limpieza con mango orientable para hornos profesionales**  
 Cleaning brush with adjustable handle for professional ovens  
 Brosse de nettoyage avec manche réglable pour fours professionnels



Barcode €  
 440754 25,00

Repuesto de cepillo de limpieza.  
 Replacement cleaning brush.  
 Brosse de nettoyage de rechange.

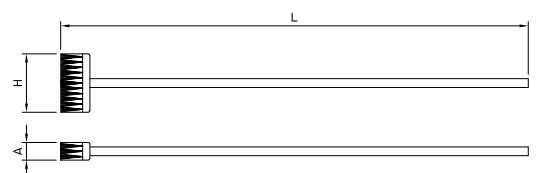
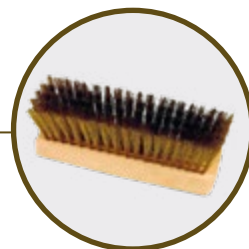

L	A	H	Gr	Barcode	€
1.740	60	200	800	440752	107,50



AD

## Utensilios para pasteleros

Pastry making utensils  
Ustensiles pour pâtisseries

**Laminador de tartas**  
Cake slicer  
Laminair pour tartes

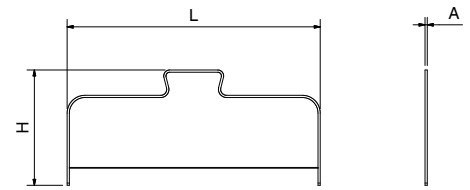

L	A	H	Gr	Barcode	€
360	12	130	170	440304	<b>4,00</b>

**Molde para laminar tartas 24/30 cms.**  
Layer cake slicer for cakes 24/30 cms.  
Moule à laminer tarte 24/30 cms.

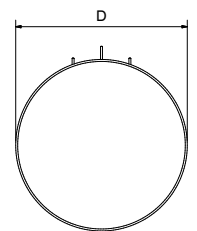

D	H	Gr	Barcode	€
240	100	720	440306	<b>13,00</b>

**Pincel de silicona y acero inox**  
Pastry brush in silicone and stainless steel  
Pinceaux en silicone et acier inox

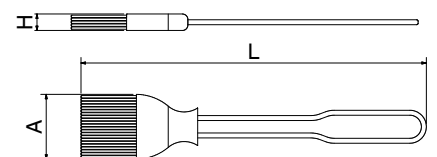

L	A	H	Gr	Barcode	€
200	50	10	48	440312	<b>4,00</b>



**Espátula de silicona y acero inox**  
Spatula in silicone and stainless steel  
Spatule en silicone et acier inox

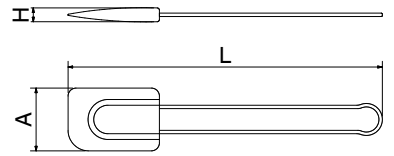

L	A	H	Gr	Barcode	€
280	58	12	89	440310	<b>5,00</b>

**Espátula pastelera**  
Bakery spatula  
Spatule à gâteau

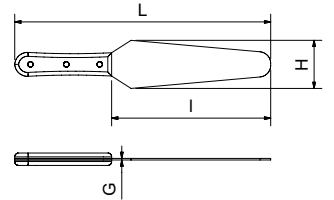

L	I	H	G	Gr	Barcode	€
215	125	26	1,0	65	441402	<b>10,00</b>
255	155	26	1,0	70	441404	<b>12,00</b>
335	205	40	1,0	170	441406	<b>20,00</b>
385	255	45	1,0	190	441408	<b>20,50</b>
440	315	45	1,5	205	441410	<b>30,00</b>
490	365	45	1,5	265	441412	<b>31,00</b>

**Conjunto de conos para relleno de crema en acero inox**  
Stuffing horn set in stainless steel  
Set de moules cornets pour garniture de crème en acier inox

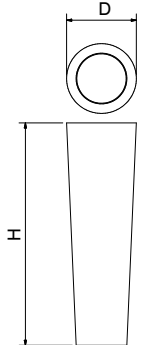

H	D	Gr	Barcode	€
65	16	5	122	440302 <b>6,50</b>
135	22	2		

**Pala inox para servir tarta**  
Stainless steel cake serving shovel  
Pelle à tarte en acier inoxydable

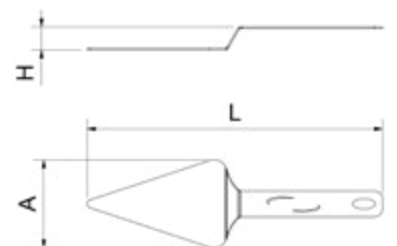

L	A	H	Gr	Barcode	€
285	85	22	130	040222	<b>8,00</b>

**Pala para tartas / pizza en acero inox**  
 Cake / pizza server in stainless steel  
 Pelle à tarte / pizza en acier inox

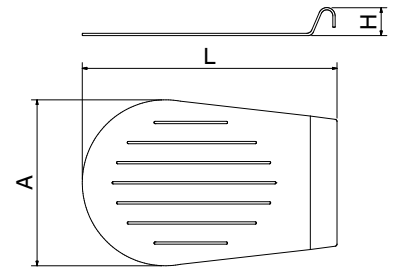

L	A	H	Gr	Barcode	€
430	290	20	356	440314	<b>20,00</b>

**Tamizador en acero inox**  
 Sifter in stainless steel  
 Tamis en acier inox

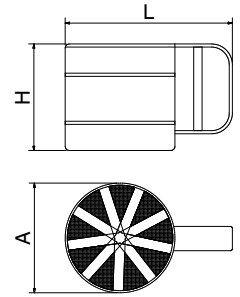

L	A	H	Gr	Barcode	€
160	105	102	195	440316	<b>18,00</b>

**Jarra medidora con fondo antideslizante 1 L**  
 Measuring jug 1 liter with non-slip bottom  
 Verre doseur avec fond antidérapant 1 litre

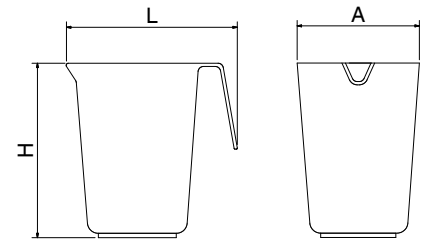

L	A	H	Gr	Barcode	€
112	145	160	160	440308	<b>12,00</b>

**Jarra medidora de cristal 1 L.**  
 Glass jug 1 L  
 Pichet doseur 1 L



**N**ovedad  
 NEW  
 arrive!

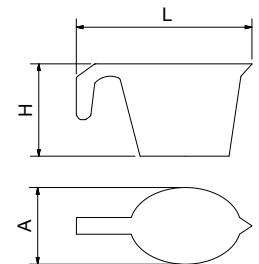

L	A	H	Gr	Barcode	€
210	150	110	160	440324	<b>12,50</b>

**Máquina para hacer churros y pastas**  
 Churros and cookies machine  
 Appareil à churros et pâtisserie



Barcode €  
 447910 7,00

**Discos de respuesto para máquina de hacer churros y pastas**  
 Spare discs for pastry and churros maker  
 Disques de rechange pour machine à churros et pâtes

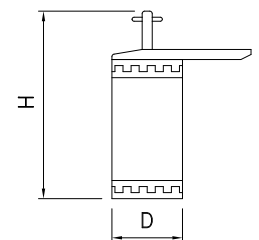
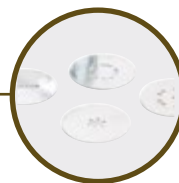

D	H	Gr	Barcode	€
70	150	530	447908	<b>36,00</b>



AD

**Servicio de mesa y barra**  
 Table and bar service  
 Service de table et comptoir

**Porta brochetas**  
 Skewer holder  
 Porte-brochettes

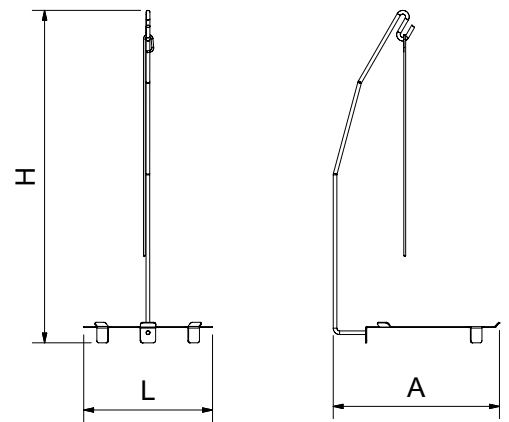

L	A	H	Kg	Barcode	€
210	270	540	1,00	040230	<b>41,00</b>

**Pinchos brocheta**  
 Kebab sticks  
 Brochettes

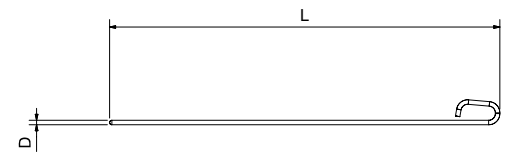

L	D	Gr	Bolsa Bag Sac	Barcode	€
261	3	15	10	040208	<b>2,00</b>
311	3	20	10	040210	<b>2,00</b>
361	3	25	10	040212	<b>2,00</b>

**Precio y peso por unidad.**  
 Unit price and weight.  
 Prix et poids unitaire.

## Cuencos

Bowls  
Bols

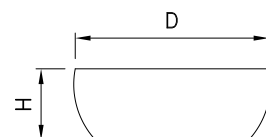

D	H	Gr	Barcode	€
140	50	0,6	99 483210	<b>3,00</b>
190	70	1,5	155 483212	<b>5,00</b>
240	90	3,0	267 483214	<b>7,00</b>

## Cuencos para salsas

Sauce bowl  
Bol à sauce

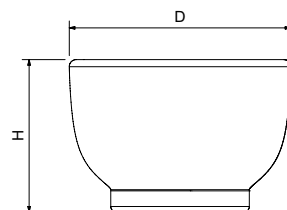

D	H	Color	Gr	Barcode	€
98	50	Red	300	434424	<b>9,00</b>
98	50	White	300	434426	<b>9,00</b>
98	50	Yellow	300	434428	<b>9,00</b>
98	50	Green	300	434430	<b>9,00</b>

## Bowls en policarbonato transparente

Bowls in transparent polycarbonate  
Bols en polycarbonate transparent

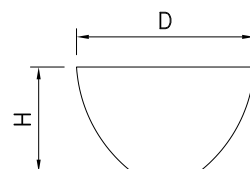

D	H	Gr	Barcode	€
120	74	115	483202	<b>4,50</b>
217	128	200	483204	<b>9,50</b>
282	174	290	483206	<b>18,00</b>

## Bowl de acero inoxidable

Stainless steel mixer bowl  
Bol mélangeur en acier inoxydable

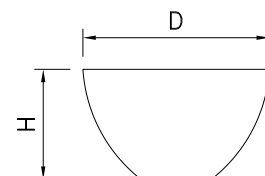

D	H	Kg	Barcode	€
130	260	0,59	480614	<b>44,00</b>
150	300	0,77	480616	<b>13,00</b>
160	360	0,86	480618	<b>55,00</b>



**Fibras chuletón rectangulares**  
 Rectangular fibre steak-boards  
 Fibras côtes de bœuf rectangulaires

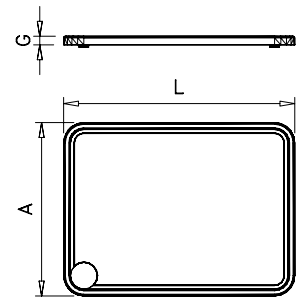

L	A	G	Kg	Barcode	€
400	200	20	1,6	432310	<b>14,00</b>

**Plato de presentación**  
 Presentation plate  
 Assiette de présentation

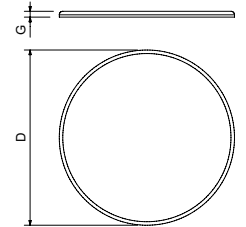

D	G	Gr	Barcode	€
300	10	900	434436	<b>18,00</b>

**Plato de presentación especial pulpo**  
 Octopus presentation plate  
 Assiette de présentation poulpe

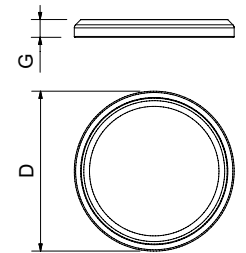

D	G	Gr	Barcode	€
180	20	648	434434	<b>14,00</b>

**Plato pizza**  
 Pizza plate  
 Assiette de pizza

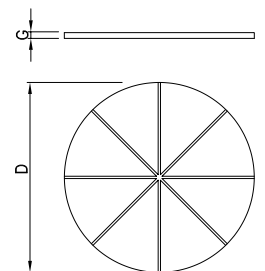

D	G	Kg	Barcode	€
300	10	1,0	434438	<b>19,00</b>

**Conjunto rompe marisco**  
 Cracker hammer seafood set  
 Set à fruits de mer

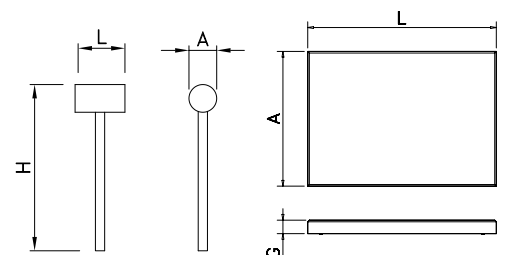

L	A	G	H	Gr	Barcode	€
100	100	15		200	434466	<b>9,00</b>
70	30		180			

**Plato de cocktail**  
Cocktail plate  
Assiette de cocktail

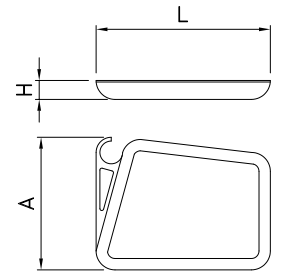

L	A	H	Gr	Barcode	€
230	175	20	80	480650	<b>3,00</b>

**Soporte inox para tacos o burritos**  
Stainless steel holder for tacos or burritos  
Support en acier inoxydable pour tacos ou burritos



**N**ovedad  
NEW  
NOUVEAU

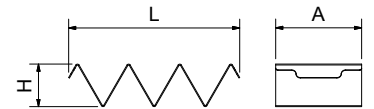

L	A	H	Gr	Barcode	€
193	97	48	300	040224	<b>9,00</b>

**Plato cuatro salsas**  
French fries dish 4 sauces  
Plat a frites 4 sauces

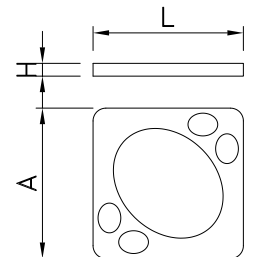

L	A	H	Gr	Barcode	€
235	235	20	199	480654	<b>7,50</b>

**Salsera circular 6 salsas**  
Round polyethylene serving board for 6 sauces  
Planché polyéthylène ronde à 6 sauces

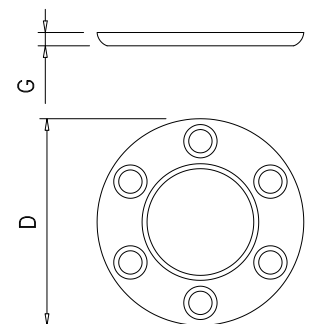

D	G	Gr	Barcode	€
330	20	500	434420 434422	<b>42,00</b>

### Salsera 8 salsas

Oval polyethylene serving board for 8 sauces  
Planche polyéthylène ovale à 8 sauces

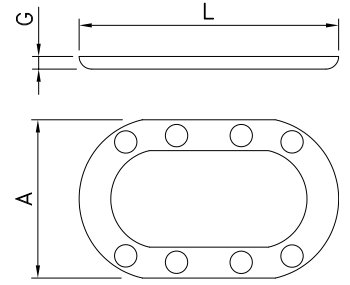

L	A	G	Kg	Barcode	€
410	250	20	1,70	434414	49,00

### Salsera rectangular 4 salsas

Rectangular polyethylene serving board for 4 sauces  
Planche polyéthylène rectangulaire à 4 sauces

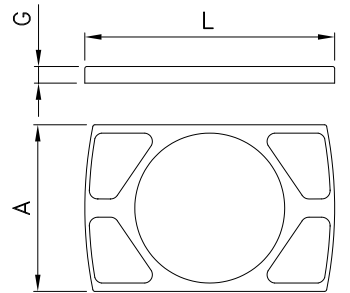

L	A	G	Kg	Barcode	€
300	200	20	1,00	434416	29,00

### Salsera rectangular 6 salsas

Rectangular polyethylene serving board for 6 sauces  
Planche polyéthylène rectangulaire à 6 sauces

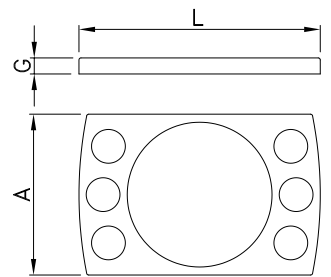

L	A	G	Kg	Barcode	€
300	200	20	1,00	434418	29,00

### Salseras de diseño 6 salsas

Serving boards design for 6 sauces  
Planche en polyéthylène à 6 sauces modèle design

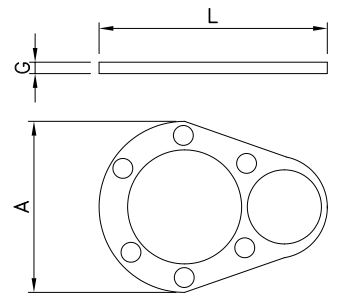

L	A	G	Kg	Barcode	€
440	300	20	2,20	434412	49,00

### Plato giratorio de cristal

Rotating glass plate  
Assiette en verre tournante

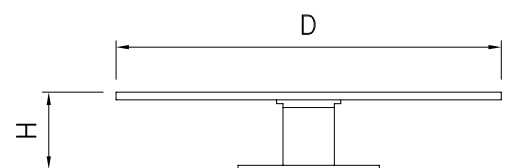

D	H	Gr	Barcode	€
300	60	500	480656	24,00

**Plato giratorio**  
Rotating plate  
Assiette tournante

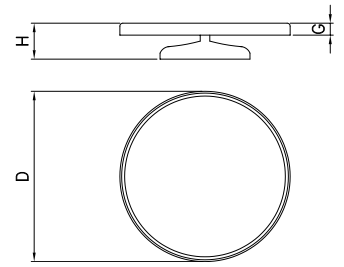

D	G	Kg	Barcode	€
285	20	1,30	434437	<b>45,00</b>

**Bandeja de frío GN cold plate**  
Cold plate GN  
Plaque froid GN cold plate



**Características:**  
Se guarda en el congelador un mínimo de 4h. Mantiene el frío durante bastante tiempo, lo que permite una presentación higiénica de los alimentos.

**Characteristics:**  
It must be kept in the freezer for 4 hours. It keeps cold for quite long time, for a hygienical presentation of food.

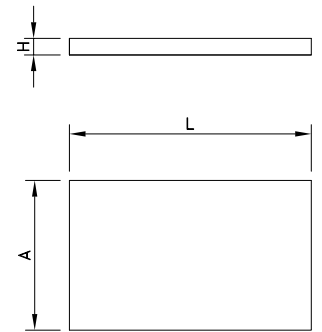

**Caractéristiques:**  
Il faut le mettre au congélateur un minimum de 4 heures. Maintient au froid durant assez longtemps, ce qui permet une présentation hygiénique des aliments.

L	A	H	Kg	Barcode	€
525	325	40	3,7	476094	<b>66,00</b>

**Barbacoa portátil profesional de sobremesa y acero inoxidable**  
Professional portable tabletop barbecue of stainless steel  
Barbecue de table portable professionnel et acier inoxydable

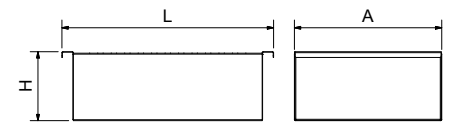

L	A	H	Kg	Barcode	€
408	284	133	4,0	043002	<b>99,00</b>

**Cesta rectangular**  
Rectangular wire basket  
Panier rectangulaire

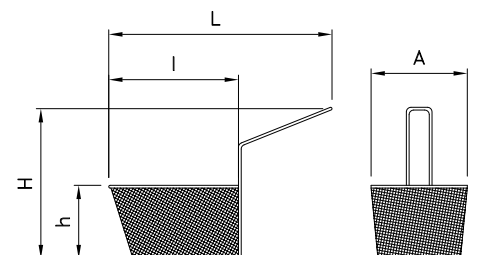

L	A	H	I	h	Gr	Barcode	€
240	105	165	140	80	160	480602	<b>6,00</b>



**Cesta redonda**  
Round wire basket  
Panier Rond

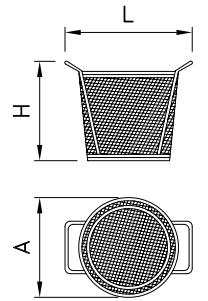

L	A	H	Gr	Barcode	€
120	95	90	125	480604	<b>6,00</b>

**Vaso en policarbonato**  
Polycarbonate glass  
Verre polycarbonate

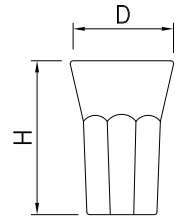

D	H	cl	Gr	Barcode	€
80	88	27 cl.	60	483260	<b>3,00</b>
90	106	40 cl.	80	483262	<b>3,00</b>
90	132	50 cl.	105	483264	<b>3,50</b>

**Copa en policarbonato**  
Polycarbonate cup  
Tasse polycarbonate

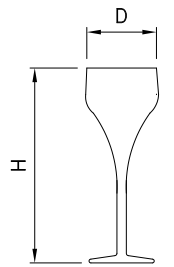

D	H	cl	Gr	Barcode	€
74	207	18 cl.	85	483250	<b>4,50</b>

**Jarra de agua**  
Water jug  
Pichet

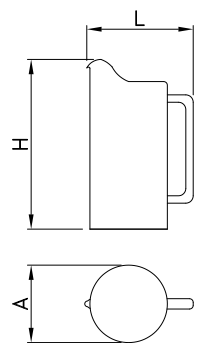

L	D	H	l	Gr	Barcode	€
230	120	170	1,5	80	483254	<b>9,00</b>

**Tenedor de mesa**  
Table fork  
Fourchette de table

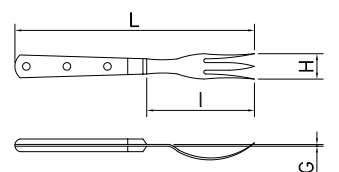

L	I	H	G	Gr	Barcode	€
190	86	23,4	1,44	53	440126	<b>9,50</b>

### Cuchara de mesa

Table spoon  
Cuillère à soupe

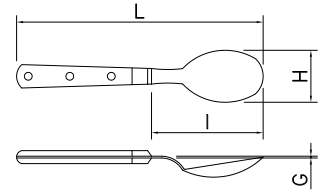

L	I	H	G	Gr	Barcode	€
192	87,10	41,04	1,33	72	440128	14,00

### Cuchillo de mesa modelo chuletero

Steak table knife  
Couteau de table modèle pour côtelette

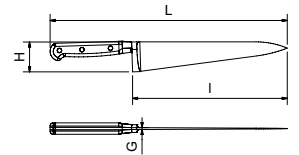

L	I	H	G	Tipo Type	Gr	Barcode	€
225	114	21	1,80	STD ↑	93	440120	8,00

### Cuchillo de mesa corte liso

Table knife, smooth cut blade  
Couteau de table bord lisse

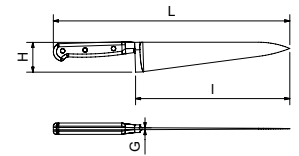

L	I	H	G	Tipo Type	Gr	Barcode	€
216	112	20	1,36	STD ↑	62	440124	9,50

### Cuchillo de mesa modelo chuletón

Ribeye steak table knife  
Couteau de table modèle pour steack

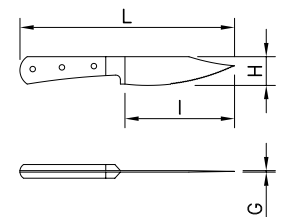

L	I	H	G	Tipo Type	Gr	Barcode	€
235	120	28	1,74	↑	88	440122	10,40

### Tenazas quita espinas

Fish pliers  
Pincettes à poissons

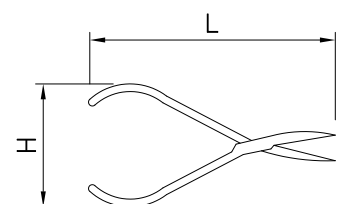

L	H	Gr	Barcode	€
160	80	160	440054	23,00

**Corta mariscos forjado**  
 Forged shellfish cracker  
 Pince à crustacés

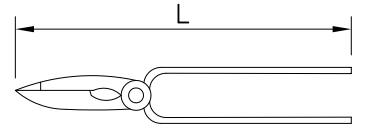

L	Gr	Barcode	€
160	130	440018	20,00

**Tenedor marisco**  
 Seafood fork  
 Fourchette à crustacés

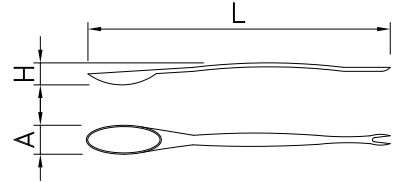

L	H	A	Gr	Barcode	€
230	3	30	180	440056	1,50

**Cascañueces**  
 Nutcracker  
 Casse-noix

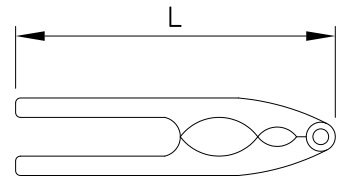

L	Gr	Barcode	€
160	220	440026	18,00

**Conjunto sal y pimienta**  
 Salt and pepper set  
 Set poivrière et salière



D	H	Gr	Barcode	€
55	110	200	440050	2,50

**Salvamantel extensible**  
 Extending tablemat  
 Dessous de plat extensible

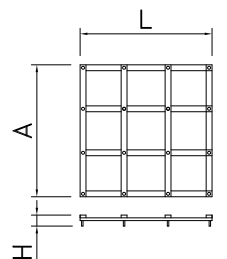

L	A	H	Gr	Barcode	€
360	360	15	250	440908	17,50



Barman  
Barman  
Barman

**Sacacorcho navaja**  
Corkscrew pocketknife  
Tire-bouchon canif

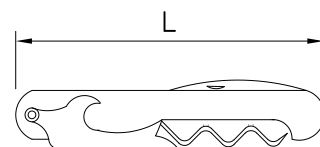

L	Gr	440022	€
110	72	440022	4,50

**Sacacorcho Tirolés**  
Corkscrew  
Tire-bouchon

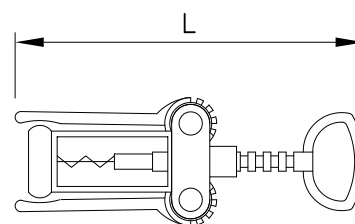

L	Gr	440024	€
170	131	440024	7,00

**Abrebotellas**  
Bottle opener  
Ouvreur de bouteille

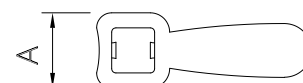
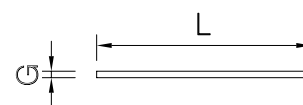

L	A	G	Gr	440044	€
100	35	3	180	440044	2,00

**Sacacorchos mural**  
Wall-mounted corkscrew  
Tire-bouchon mural



**Espigas macho para sacacorchos de pared 483416**

Replacement male spiral for wall-mounted corkscrew 483416  
Épis mâles pour tire-bouchon mural 483416



483434 **18,00**

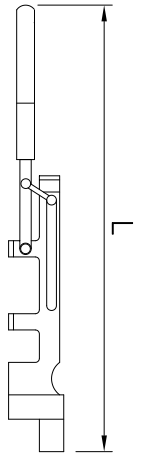

L	Kg	Barcode	€
550	2,52	483416	<b>237,00</b>

**Tapón inox**  
Stainless steel stopper  
Bouchon inox



Tapón de cierre hermético para mantener el vino fresco durante más tiempo. Fácil manejo.

Hermetic stopper, for a fresher wine for longer. Easy to use.

Bouchon de fermeture hermétique pour maintenir le vin frais durant plus de temps. Usage facile.

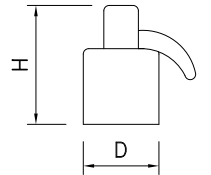

D	H	Gr	Barcode	€
35	80	5,5	483430	<b>8,00</b>

**Tapón de corona acero inox**  
Bottle crown cap in stainless steel  
Capsule couronne acier inox

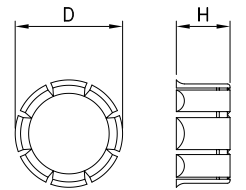

D	H	Gr	Barcode	€
40	20	5	483418	<b>1,80</b>

**Tapón vertedor inox (2 ud)**  
Stainless steel pouring cap (2 pc)  
Bouchon verseur en acier inoxydable (2 pc)

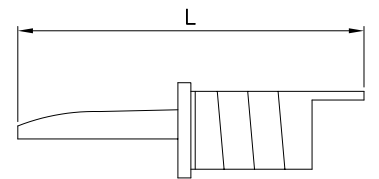

L	Gr	Barcode	€
80	40,00	483420	<b>3,00</b>

**Tapón hermético acero inox (2 uds.)**  
Sealing plug (2 pieces)  
Bouchon hermétique acier inox (2 pièces)

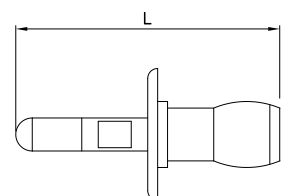

L	Gr	Barcode	€
80	44,16	483422	<b>5,00</b>

### Tapón cava cromado

Chromed stopper for sparkling wine  
Bouchon pour bouteille de champagne chromé

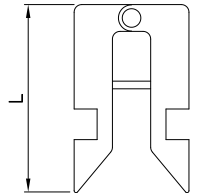

L	Gr	Barcode	€
50	89,66	483424	<b>8,75</b>

### Anillo acero inox antigoteo para botella de vino

Wine drip collar in stainless steel  
Anneau de chute acier inox anti-gouttes pour bouteille de vin

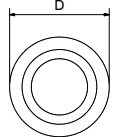
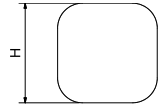

D	H	Gr	Barcode	€
40	40	10	483408	<b>2,00</b>

### Bomba de vacío para botella de vino

Wine bottle vacuum pump  
Tire-bouchon à air pour bouteille de vin

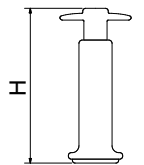

483432 € 3,50

Juego de dos tapones de repuesto para bomba vacío  
2 Wine Stoppers for Vacuum pump  
2 Bouchons de vin pour Pompe vide d'air

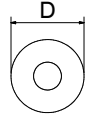

D	H	Gr	Barcode	€
50	140	10	483410	<b>9,00</b>

### Oxigenador de vino

Wine aerator  
Oxygénateur de vin

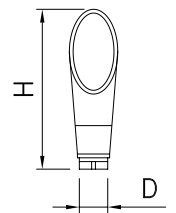

D	H	Gr	Barcode	€
24	125	50	483412	<b>16,00</b>

### Escanciador de vino

Wine pourer  
Verseur

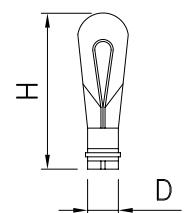

D	H	Gr	Barcode	€
15	76	16	483426	<b>5,50</b>

## Termómetro digital para botella de vino

Wine bottle digital thermometer

Thermomètre digital pour bouteille de vin



Para controlar la temperatura del vino sin abrir la botella.

Se puede usar en la nevera o refrigerador

Lectura de temperatura instantánea con intervalos de 1°C.

Para botellas de hasta 100 mm. de diámetro.

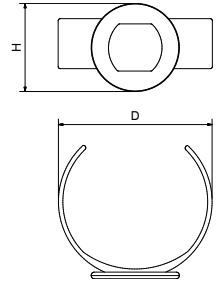

Pour contrôler la température du vin sans ouvrir la bouteille.

Il peut être utilisé dans la glacière ou réfrigérateur

Lecture de la température instantanée à des intervalles de 1°C.

Pour les bouteilles jusqu'à 100 mm. de diamètre.

To check the wine temperature without opening the bottle.

It can be used in the fridge or in the ice chest.

Instant display of temperature with intervals of 1°C.

For bottles up to 100 mm. diameter.

D	H	Gr	Barcode	€
40	70	22	483414	<b>16,00</b>

AD

## Coctelera

Shaker

Shaker

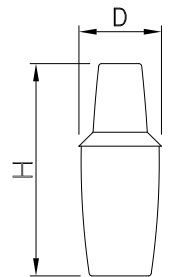

D	H	Gr	Barcode	€
75	160	250	440058	<b>6,00</b>

## Pala para hielo en acero inox

Stainless steel ice shovel

Pelle à glaçons en acier inoxydable

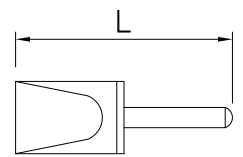

L	Gr	Barcode	€
190	500	474457	<b>19,00</b>

## Pinza para cubitos de hielo

Ice tongs

Pinces à glace

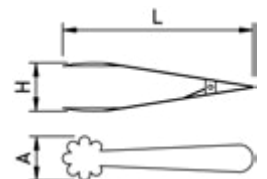

L	A	H	Gr	Barcode	€
190	35	50	100	440008	<b>4,00</b>

**Cubitera con tapa de acero inox**  
 Ice bucket with stainless steel lid  
 Seau à glaçons avec couvercle en acier inoxydable

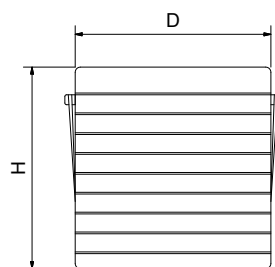

D	H	Gr	Barcode	€
170	175	740	440098	<b>43,50</b>

**Champanera acero inox**  
 Champagne cooler bucket in stainless steel  
 Seau à Champagne acier inox

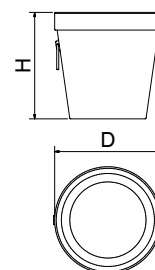

D	H	Gr	Barcode	€
220	250	3.8	442 483404	<b>15,00</b>

**Pie de champanera**  
 Champagne cooler stand  
 Pied pour seau à champagne

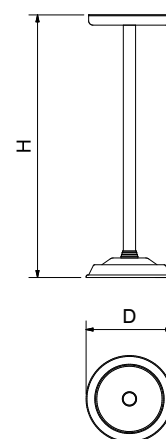

D	H	Kg	Barcode	€
250	750	4,50	483406	<b>47,00</b>



**Termo**  
Thermos flask jug  
Thermos

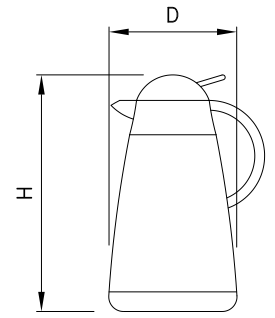

D	H		Gr		€
130	290	2	811	480244	<b>29,00</b>

**Cafetera express inox**  
Express coffee pot  
Cafetière express inox

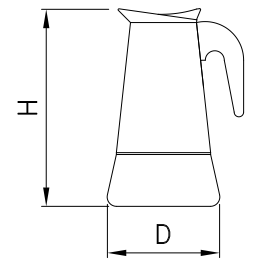

D	H			Gr		€
120	210	9	1	818	480240	<b>25,00</b>

**Cafetera italiana tradicional 6 ó 12 tazas**  
6 or 12 cups traditional Italian coffee-maker  
Cafetière italienne traditionnelle 6 ou 12 tasses

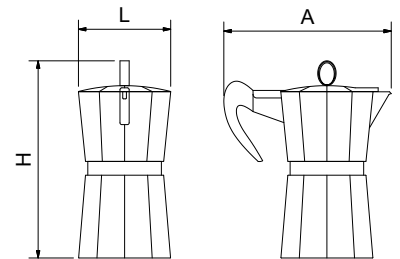

L	A	H		Gr		€
130	200	350	12	850	480242	<b>31,00</b>

**Juego de café de 5 piezas para 6 tazas**  
6 cups coffee set of 5 pieces  
Service à café 5 pièces pour 6 tasses

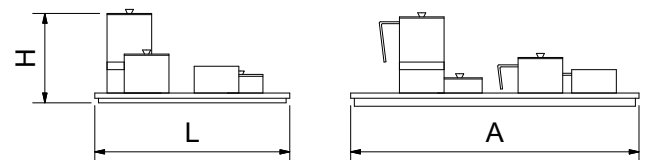

L	A	H		Kg		€
240	355	110	6	1,70	480243	<b>113,00</b>



## Servicio a domicilio

Take away & delivery  
Livraison à domicile

### Caja de reparto/distribución apilable con tapa

Stackable distribution box with lid

Boîte de distribution empilable avec couvercle

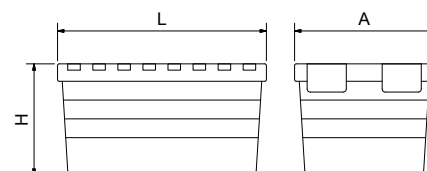

L	A	H		Kg		€
600	400	320	60	2,90	483030	<b>34,00</b>
600	400	360	66	3,55	483034	<b>36,00</b>
600	400	410	77	3,75	483032	<b>39,00</b>

### Forro isotermo interior para cajas de reparto / distribución

Inner isothermal lining for delivery / distribution boxes

Doublure intérieure isotherme pour boîtes de livraison / distribution

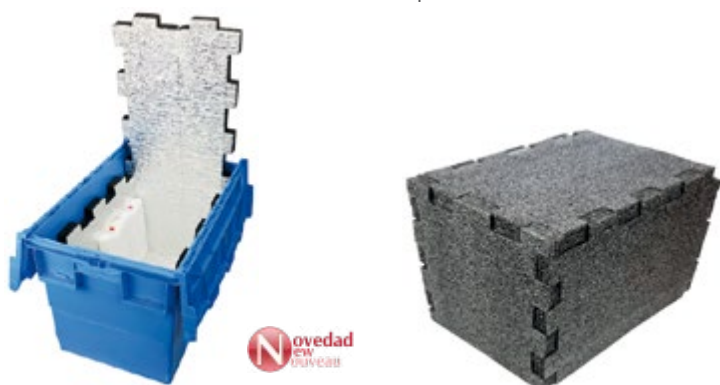

**N**ovedad  
New  
nouveau



L	A	H	Gr		€
		300	490	483031	<b>58,50</b>
550	350	380	650	483033	<b>72,50</b>

## Contenedor Gastronorm aislamiento térmico

Gastronorm container for thermic isolation  
Bac Gastronorm d'isolation thermique



Modelo Model Model	L	A	H	Gr	Barcode	€
1/1 - 120	600	400	170	550	487802	<b>69,00</b>
1/1 - 170	600	400	230	620	487804	<b>74,00</b>
1/1 - 220	600	400	270	710	487806	<b>82,00</b>

AD

## Placa eutéctica GN 1/1 acumulador de frío de 0 a -21°C

Eutectic plate GN 1/1 cold accumulator from 0 to -21°C  
Plaque eutectique GN 1/1 accumulateur de froid de 0 à -21°C



**N**ovedad  
new  
product

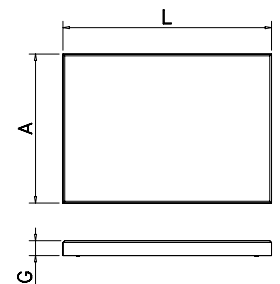

L	A	H	Kg	Barcode	€
530	325	30	5,10	487818	<b>132,00</b>

## Contenedor isotérmico Euronorm 82 L.

Isothermal Euronorm container 82 liters  
Conteneur isotherme Euronorm 82 L.



**N**ovedad  
new  
product



L	A	H	Kg	Barcode	€
690	490	370	1,60	487808	<b>120,00</b>

## Envase take away / delivery rectangular con tapa

Take away / delivery rectangular container with lid

Conteneur rectangulaire à emporter ou de livraison avec couvercle



### Características:

Fabricado en plástico polipropileno negro, este envase rectangular con tapa es ideal para servir alimentos a domicilio.

Reutilizable, reciclable y además es apto para lavavajillas, frigorífico y microondas sin grill.

Además, a diferencia de otros envases take away, son apilables. Esto permitirá reducir espacio en sus cocinas.



### Characteristics:

Made of black polypropylene, this rectangular container with lid is ideal for food delivery service.

It is reusable, recyclable and is also suitable for dishwashers, refrigerators and microwaves without grill.

In addition, unlike other take away containers, they are stackable. This will reduce space in your kitchens.

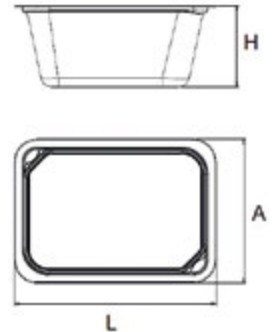

### Caractéristiques:

Fabriqué en plastique polypropylène noir, ce contenant rectangulaire avec couvercle est idéal pour servir des aliments à la maison. Il est réutilisable, recyclable et convient également aux lave-vaisselle, réfrigérateurs et micro-ondes sans grill.

De plus, contrairement aux autres contenants à emporter, ils sont empilables. Cela réduira l'espace dans votre cuisine.

L	A	H	Gr	Barcode	€
190	136	76,5	700	480608	3,00

## Envase take away / delivery redondo con tapa

Take away / delivery rounded container with lid

Conteneur rond à emporter ou de livraison avec couvercle



### Características:

Fabricado en plástico polipropileno negro, este envase redondo con tapa es ideal para servir alimentos a domicilio.

Reutilizable, reciclable y además es apto para lavavajillas, frigorífico y microondas sin grill.

Además, a diferencia de otros envases take away, son apilables. Esto permitirá reducir espacio en sus cocinas.

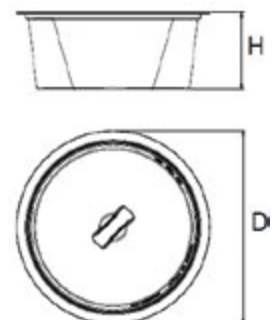

### Caractéristiques:

Fabriqué en plastique polypropylène noir, ce contenant rond avec couvercle est idéal pour servir des aliments à la maison. Il est réutilisable, recyclable et convient également aux lave-vaisselle, réfrigérateurs et micro-ondes sans grill.

De plus, contrairement aux autres contenants à emporter, ils sont empilables. Cela réduira l'espace dans votre cuisine.

### Characteristics:

Made of black polypropylene, this rounded container with lid is ideal for food delivery service. It is reusable, recyclable and is also suitable for dishwashers, refrigerators and microwaves without grill.

In addition, unlike other take away containers, they are stackable. This will reduce space in your kitchens.

D	H	Gr	Barcode	€
155	62	500	480610	4,00



# LAVAMANOS

HAND WASH BASINS  
LAVE-MAINS

## NOVEDADES

NEWS  
NOUVEAUTÉS



192



197



197



198



201



201



# LAVAMANOS DE ACERO INOXIDABLE DE ACCIONAMIENTO NO MANUAL

HANDS-FREE OPERATED STAINLESS STEEL HAND WASHBASIN  
LAVE-MAINS EN ACIER INOXYDABLE ACTIONNEMENT NON MANUEL

## Características principales:

A partir de esta página, encontrará una gran variedad de lavamanos inoxidable de accionamiento no manual, cuyo objetivo es facilitar la correcta higiene de las manos evitando que el usuario tenga que tocar con sus manos cualquier parte del mismo. Esto además mitiga el riesgo de contaminación cruzada entre usuarios.

Para mayor efectividad en el lavado de manos, toda nuestra gama es de agua fría y caliente, siendo habitual que el agua salga mezclada aunque hay algunos modelos que permiten elegir entre fría, caliente o mezclada.

Todos nuestros lavamanos cumplen con las normativas vigentes y cuentan con sus certificados correspondientes.

## Main characteristics:

From this page on, you will find a wide variety of hands-free operated stainless steel hand washbasins, the objective of which is to prevent the user from touching any part of the device thus obtaining proper hand hygiene. This also mitigates the risk of cross contamination among users.

Our entire range is fitted with inlets for hot and cold water, for a more effective hand washing. Although the most common models operate with mixed water, there are some that allow the user to choose between cold, hot or mixed.

All our sinks comply with current regulations and have their corresponding certificates.

## Main characteristics:

À partir de cette page, vous trouverez une grande variété de lave-mains en acier inoxydable d'actionnement non manuelle, dont l'objectif est de faciliter une bonne hygiène des mains en évitant à l'utilisateur d'avoir à en toucher une partie avec ses mains. Cela atténue également le risque de contamination croisée entre les utilisateurs.

Pour une plus grande efficacité du lavage des mains, toute notre gamme est d'eau chaude et froide, il est courant que l'eau sorte mélangée bien qu'il existe certains modèles qui vous permettent de choisir entre froide, chaude ou mixte.

Tous nos lave-mains sont conformes à la réglementation en vigueur et ont leurs certificats correspondants.

# LAVAMANOS

WASHBASINS / LAVE-MAIN



Caño giratorio en  
acero inoxidable  
Stainless steel  
rotating spout  
Jet giratoire en acier  
inoxydable



Rebosadero  
Overflow  
Déversoir



Esquinas  
redondeadas  
Rounded corners  
Coins arrondis



Reborde anti  
derrames  
Anti-spill flange  
Bride anti-déversement



Pulsador  
temporizado de alta  
calidad en acero  
inoxidable  
High-quality stainless  
steel timed switch  
Interrupteur  
chronométré en acier  
inoxydable de haute  
qualité

Lavamanos registrables de agua fría y caliente  
Hand wash basin cold and hot water with removable door  
Lave-mains avec porte amovible d'eau froide et chaude

061426

061012

061414

XS

Características  
Characteristics  
Caractéristiques

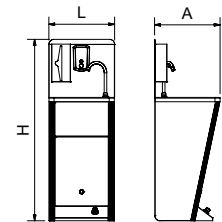
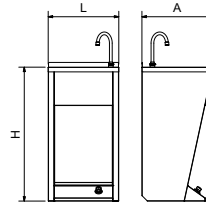
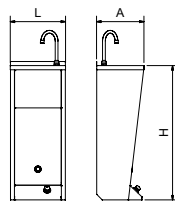

Tipo de accionamiento Operation Accionnement	Pulsador Push button Poussoir	Pulsador Push button Poussoir	Pulsador Push button Poussoir
Caudal Flow Débit	9 l/min	9 l/min	9 l/min
Tipo de agua Type of water Type d'eau	Mezclada Mixed Mélangée	Mezclada Mixed Mélangée	Mezclada Mixed Mélangée
Conjunto peto, jabonera y dispensador Raised backsplash for mobile hand washbasin Dossieret inox postérieur pour lave-mains autonome	-----	Opcional Optional Optionnel	<input checked="" type="checkbox"/>
Papelera integrada Waste bin integrated Corbeille a papier intégrée	<input checked="" type="checkbox"/>	-----	<input checked="" type="checkbox"/>
L	350 mm	450 mm	450 mm
A	300 mm	450 mm	450 mm
H	850 mm	850 mm	1250 mm
Peso / Weight / Poids	9,00 Kg.	11,15 Kg.	14,20 Kg.
Unidades por palet Units per pallet Unités par palette	18	8	8
Tipo de cubeta Type of bowl Type d'évier	Redonda con reborde Rounded with anti-drip edge Arrondi avec rebord	Rectangular con reborde Rectangular with anti-drip edge Rectangulaire avec rebord	Redonda con reborde Rounded with anti-drip edge Arrondi avec rebord
Dimensiones cubeta Bowl dimensions Dimensions évier	Ø 260 mm	370x340 mm	Ø 390 mm
Profundidad cubeta Bowl depth Profondeur évier	115 mm	170 mm	150 mm
	<b>304,00€</b>	<b>295,00€</b>	<b>425,00€</b>



061014

061002

061004

061008

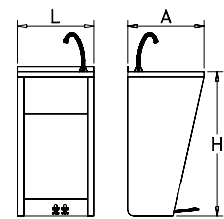
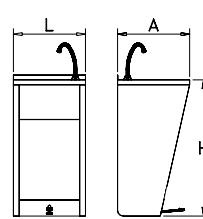
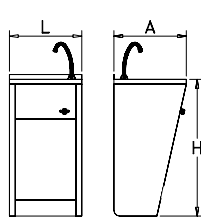
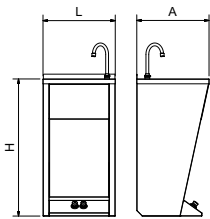

2x Pulsador  
2x Push button  
2x Poussoir

Pulsador  
Push button  
Poussoir

Pedal  
Pedal  
Pédale

2x Pedal  
2x Pedal  
2x Pédale

9 l/min

9 l/min

7,5 l/min

7,5 l/min

Fría, Caliente o Mezclada  
Cold, hot or mixed  
Froid, chaud ou mélangé

Mezclada  
Mixed  
Mélangée

Mezclada  
Mixed  
Mélangée

Fría, Caliente o Mezclada  
Cold, hot or mixed  
Froid, chaud ou mélangé

Opcional  
Optional  
Optionnel

Opcional  
Optional  
Optionnel

Opcional  
Optional  
Optionnel

Opcional  
Optional  
Optionnel

-----

-----

-----

-----

450 mm

450 mm

450 mm

450 mm

450 mm

450 mm

450 mm

450 mm

850 mm

850 mm

850 mm

850 mm

12,00 Kg.

11,96 Kg.

11,96 Kg.

12,66 Kg.

8

8

8

8

Rectangular con reborde  
Rectangular with anti-drip edge  
Rectangulaire avec rebord

Rectangular con reborde  
Rectangular with anti-drip edge  
Rectangulaire avec rebord

Rectangular con reborde  
Rectangular with anti-drip edge  
Rectangulaire avec rebord

Rectangular con reborde  
Rectangular with anti-drip edge  
Rectangulaire avec rebord

370x340 mm

370x340 mm

370x340 mm

370x340 mm

170 mm

170 mm

170 mm

170 mm

**377,00€****344,00€****352,00€****351,00€**

**Lavamanos murales**  
Wall-mounted hand  
washbasins  
Lave-main mural

061422

061402

061424

061432



**Características**  
Characteristics  
Caractéristiques

XS

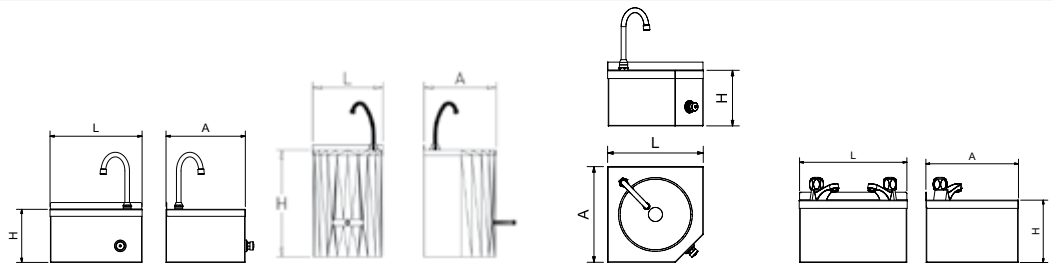

<b>Tipo de accionamiento</b> Operation Accionnement	<b>Pulsador temporizado</b> Timed switch Interrupteur chronométré	<b>Palanca rodilla</b> Knee-operated lever Lever de genou	<b>Pulsador temporizado</b> Timed switch Interrupteur chronométré	<b>2x Pomos</b> 2x Knob 2x Bouton
<b>Caudal</b> Flow Débit	9 l/min	8 l/min	9 l/min	16 l/min
<b>Tipo de agua</b> Type of water Type d'eau	<b>Mezclada</b> Mixed Mélangée	<b>Mezclada</b> Mixed Mélangée	<b>Mezclada</b> Mixed Mélangée	<b>Fría y Caliente</b> Cold and hot Froid et chaud
<b>Caño giratorio</b> Rotating spout Bec tournant de robinet commande	<input checked="" type="checkbox"/>	<input checked="" type="checkbox"/>	<input checked="" type="checkbox"/>	-----
<b>Conjunto peto, jabonera y dispensador</b> Raised backsplash for mobile hand washbasin Dosseret inox postérieur pour lave-mains autonome	<b>Opcional</b> Optional Optionnel	<b>Opcional</b> Optional Optionnel	<b>Opcional</b> Optional Optionnel	<b>Opcional</b> Optional Optionnel
<b>Papelera</b> Waste bin Corbeille a papier	<b>Opcional</b> Optional Optionnel	<b>Opcional</b> Optional Optionnel	<b>Opcional</b> Optional Optionnel	<b>Opcional</b> Optional Optionnel
<b>L</b>	350 mm	350 mm	350 mm	350 mm
<b>A</b>	300 mm	300 mm	350 mm	300 mm
<b>H</b>	215 mm	500 mm	205 mm	200 mm
<b>Peso / Weight / Poids</b>	3,91 Kg.	8,00 Kg.	3,00 Kg.	2,32 Kg.
<b>Unidades por palet</b> Units per pallet Unités par palette	72	24	72	72
<b>Tipo de cubeta</b> Type of bowl Type d'évier	<b>Redonda con reborde</b> Rounded with anti-drip edge Arrondi avec rebord	<b>Redonda con reborde</b> Rounded with anti-drip edge Arrondi avec rebord	<b>Redonda</b> Rounded Arrondi	<b>Redonda con reborde</b> Rounded with anti-drip edge Arrondi avec rebord
<b>Dimensiones cubeta</b> Bowl dimensions Dimensions évier	Ø 260 mm	Ø 260 mm	Ø 260 mm	Ø 260 mm
<b>Profundidad cubeta</b> Bowl depth Profondeur évier	115 mm	115 mm	140 mm	115 mm
	<b>160,00€</b>	<b>289,00€</b>	<b>310,00€</b>	<b>199,00€</b>

061202

061212

061406

061204

061208

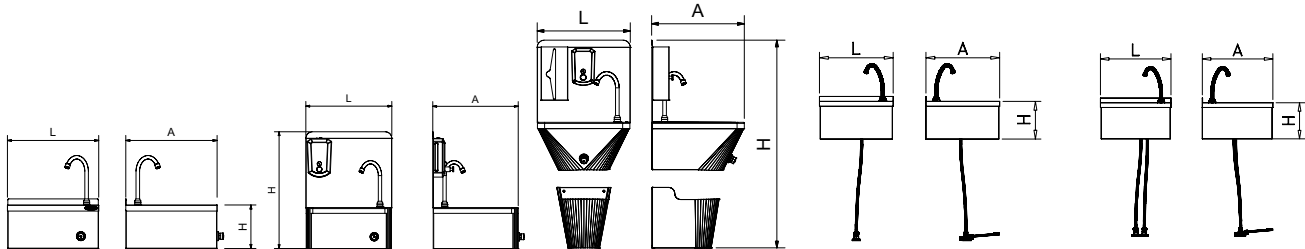

Pulsador temporizado  
Timed switch  
Interrupteur chronométré

Pulsador temporizado  
Timed switch  
Interrupteur chronométré

Pulsador temporizado  
Timed switch  
Interrupteur chronométré

Pedal  
Pedal  
Pédale

2x Pedal  
2x Pedal  
2x Pédale

9 l/min

9 l/min

9 l/min

7,5 l/min

7,5 l/min

Mezclada  
Mixed  
Mélangée

Mezclada  
Mixed  
Mélangée

Mezclada  
Mixed  
Mélangée

Mezclada  
Mixed  
Mélangée

Fría, Caliente o Mezclada  
Cold, hot or mixed  
Froid, chaud ou mélangé



Opcional  
Optional  
Optionnel

\*Dispensador tissues  
no  
Not tissues dispenser  
Dispensateur de tissues  
non



Opcional  
Optional  
Optionnel

Opcional  
Optional  
Optionnel

Opcional  
Optional  
Optionnel

Opcional  
Optional  
Optionnel



Opcional  
Optional  
Optionnel

Opcional  
Optional  
Optionnel

450 mm

453 mm

450 mm

450 mm

450 mm

450 mm

450 mm

450 mm

450 mm

450 mm

215 mm

615 mm

1050 mm

215 mm

215 mm

5,59 Kg.

7,00 Kg.

10,50 Kg.

5,46 Kg.

6,60 Kg.

36

36

16

36

36

Redonda con reborde  
Rounded with anti-drip  
edge  
Arrondi avec rebord

Redonda con reborde  
Rounded with anti-drip  
edge  
Arrondi avec rebord

Redonda con reborde  
Rounded with anti-drip  
edge  
Arrondi avec rebord

Redonda con reborde  
Rounded with anti-drip  
edge  
Arrondi avec rebord

Redonda con reborde  
Rounded with anti-drip  
edge  
Arrondi avec rebord

Ø 390 mm

Ø 390 mm

Ø 390 mm

Ø 390 mm

Ø 390 mm

150 mm

150 mm

150 mm

150 mm

150 mm

**197,00€****348,00€****401,00€****220,00€****278,00€**

**Lavamanos registrables electrónicos**  
Sensor operated hand washbasins  
with and without removable door  
Lave-mains électriques autonomes

061462

061010

061418

**Características**  
Characteristics  
Caractéristiques

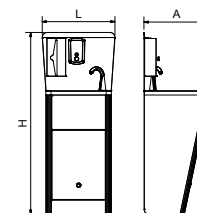
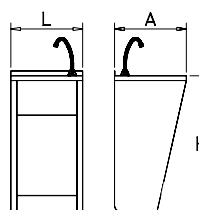
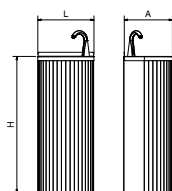

**Tipo de accionamiento**  
Operation  
Accionnement

**Sensor sin contacto**  
Non-contact sensor  
Capteur sans contact

**Sensor sin contacto**  
Non-contact sensor  
Capteur sans contact

**Sensor sin contacto**  
Non-contact sensor  
Capteur sans contact

**Caudal**  
Flow  
Débit

8 l/min

8 l/min

8 l/min

**Tipo de agua**  
Type of water  
Type d'eau

**Mezclada**  
Mixed  
Mélangée

**Mezclada**  
Mixed  
Mélangée

**Mezclada**  
Mixed  
Mélangée

**Conjunto peto, jabonera y dispensador**  
Raised backsplash for mobile hand washbasin  
Dosseret inox postérieur pour lave-mains autonome

-----

**Opcional**  
Optional  
Optionnel





**Papelera integrada**  
Waste bin integrated  
Corbeille à papier intégrée

-----

-----



<b>L</b>	350 mm	450 mm	450 mm
<b>A</b>	300 mm	450 mm	450 mm
<b>H</b>	850 mm	850 mm	1250 mm
<b>Peso / Weight / Poids</b>	7,00 Kg.	12,54 Kg.	15,20 Kg.
<b>Unidades por palet</b> Units per pallet Unités par palette	18	8	8
<b>Tipo de cubeta</b> Type of bowl Type d'évier	<b>Redonda con reborde</b> Rounded with anti-drip edge Arrondi avec rebord	<b>Rectangular con reborde</b> Rectangular with anti-drip edge Rectangulaire avec rebord	<b>Redonda con reborde</b> Rounded with anti-drip edge Arrondi avec rebord
<b>Dimensiones cubeta</b> Bowl dimensions Dimensions évier	Ø 260 mm	370x340 mm	Ø 390 mm
<b>Profundidad cubeta</b> Bowl depth Profondeur évier	115 mm	170 mm	150 mm
<b>Funcionamiento grifo</b> Tap operation Opération de robinet	2x  CR123	2x  CR123	2x  CR123
	<b>556,00€</b>	<b>449,00€</b>	<b>531,00€</b>

**Lavamanos murales electrónicos**  
Sensor operated wall-mounted hand washbasins  
Lave-mains mural électronique

061404





061448

061210

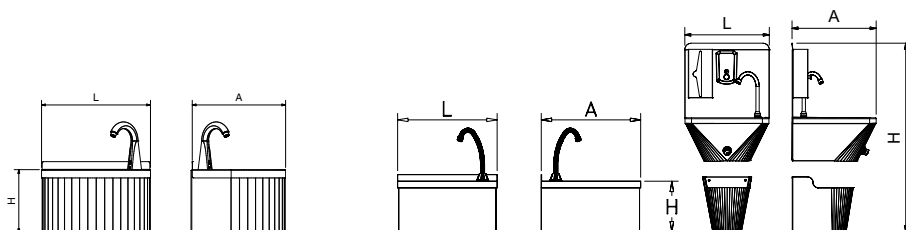
061410

**Características**  
Characteristics  
Caractéristiques



Tipo de accionamiento Operation Accionnement	Sensor sin contacto Non-contact sensor Capteur sans contact	Sensor sin contacto Non-contact sensor Capteur sans contact	Sensor sin contacto Non-contact sensor Capteur sans contact	Sensor sin contacto Non-contact sensor Capteur sans contact
Caudal Flow Débit	8 l/min	8 l/min	8 l/min	8 l/min
Tipo de agua Type of water Type d'eau	Mezclada Mixed Mélangée	Fría, Caliente o Mezclada Cold, hot or mixed Froid, chaud ou mélangé	Mezclada Mixed Mélangée	Mezclada Mixed Mélangée
Conjunto peto, jabonera y dispensador Raised backsplash for mobile hand washbasin Dossieret inox postérieur pour lave-mains autonome	-----	-----	Opcional Optional Optionnel	<input checked="" type="checkbox"/>
Papelera Waste bin Corbeille a papier	Opcional Optional Optionnel	Opcional Optional Optionnel	Opcional Optional Optionnel	<input checked="" type="checkbox"/>
L	350 mm	350 mm	450 mm	450 mm
A	300 mm	300 mm	450 mm	450 mm
H	200 mm	200 mm	215 mm	1050 mm
Peso / Weight / Poids	6,00 Kg.	6,00 Kg.	6,14 Kg.	12,66 Kg.
Unidades por palet Units per pallet Unités par palette	72	72	36	16
Tipo de cubeta Type of bowl Type d'évier	Redonda con reborde Rounded with anti-drip edge Arrondi avec rebord	Redonda con reborde Rounded with anti-drip edge Arrondi avec rebord	Redonda con reborde Rounded with anti-drip edge Arrondi avec rebord	Redonda con reborde Rounded with anti-drip edge Arrondi avec rebord
Dimensiones cubeta Bowl dimensions Dimensions évier	Ø 260 mm	Ø 260 mm	Ø 390 mm	Ø 390 mm
Profundidad cubeta Bowl depth Profondeur évier	115 mm	115 mm	150 mm	150 mm
Funcionamiento grifo Tap operation Opération de robinet	2x  CR123	2x  CR123	2x  CR123	2x  CR123
	<b>391,00€</b>	<b>378,00€</b>	<b>324,00€</b>	<b>489,00€</b>

# PORTATIL SIN NECESIDAD DE TOMAS DE AGUA NI DESAGÜE

PORTABLE WITH NO NEED FOR WATER OR DRAINAGE OUTLETS  
PORTABLE, SANS BESOIN DE SORTIES D'EAU OU DE DRAINAGE

## Características principales:

**Portabilidad:** Un lavamanos autónomo de Fricosmos es fácilmente transportable y no requiere de instalaciones complicadas. Puede ser utilizado en diferentes ubicaciones según las necesidades, lo cual lo hace ideal para eventos al aire libre, ferias, hospitales, escuelas, oficinas y cualquier otro lugar donde se necesite un lavamanos adicional de forma temporal o permanente.

**Funcionamiento sin conexión a la red de agua:** Los lavamanos autónomos de Fricosmos están equipados con sistemas de almacenamiento de agua y bombas que les permiten funcionar sin necesidad de estar conectados a la red de agua. Esto es especialmente útil en lugares donde no hay acceso a una fuente de agua cercana o en situaciones de emergencia.

**Higiene y seguridad:** Estos lavamanos fabricados en acero inoxidable facilitan su limpieza y desinfección. Además, opcionalmente cuentan con dispensadores de jabón y de papel, lo que fomenta una correcta higiene de manos y reduce la propagación de enfermedades.

**Ahorro de tiempo y recursos:** Al tener un lavamanos autónomo de Fricosmos, no es necesario que las personas se desplacen largas distancias para lavarse las manos. Esto ahorra tiempo y recursos, ya que se evitan los traslados innecesarios y se fomenta una buena higiene en el lugar donde se requiere.

**Cumplimiento normativo:** Estos lavamanos cumplen con las normativas y regulaciones sanitarias vigentes, lo cual es especialmente importante en entornos comerciales y de atención médica. Esto garantiza que se cumplan los estándares de higiene y se mantenga un entorno seguro para los usuarios.

Estas son solo algunas de las ventajas de un lavamanos autónomo de Fricosmos. Es importante tener en cuenta que las características y especificaciones pueden variar según el modelo específico que elijas. Si estás considerando adquirir un lavamanos autónomo, te recomendaría investigar más sobre los productos de Fricosmos y sus características para asegurarte de que se ajusten a tus necesidades particulares.

## Main characteristics:

**Portability:** A self-contained hand wash basin from Fricosmos is easily transportable and does not require complicated installations. It can be used in different locations as needed, making it ideal for outdoor events, fairs, hospitals, schools, offices, and any other place where an additional hand wash basin is needed temporarily or permanently.

**Operation without water connection:** Fricosmos self-contained hand wash basins are equipped with water storage systems and pumps that allow them to function without being connected to the water supply. This is especially useful in locations where there is no access to a nearby water source or in emergency situations.

**Hygiene and safety:** These hand wash basins, made of stainless steel, facilitate cleaning and disinfection. Additionally, they optionally come with soap and paper dispensers, promoting proper hand hygiene and reducing the spread of diseases.

**Time and resource-saving:** Having a self-contained hand wash basin from Fricosmos eliminates the need for people to travel long distances to wash their hands. This saves time and resources by avoiding unnecessary travel and promoting good hygiene at the required location.

**Compliance with regulations:** These hand wash basins comply with current sanitary regulations and standards, which is especially important in commercial and healthcare settings. This ensures that hygiene standards are met and maintains a safe environment for users.

These are just some of the advantages of a self-contained hand wash basin from Fricosmos. It's important to note that features and specifications may vary depending on the specific model you choose. If you're considering acquiring a self-contained hand wash basin, I would recommend researching more about Fricosmos products and their features to ensure they fit your specific needs.

## Main characteristics:

**Portabilité :** Un évier autonome de Fricosmos est facilement transportable et ne nécessite pas d'installations compliquées. Il peut être utilisé dans différents endroits selon les besoins, ce qui le rend idéal pour les événements en plein air, les foires, les hôpitaux, les écoles, les bureaux et tout autre lieu nécessitant un évier supplémentaire de manière temporaire ou permanente.

**Fonctionnement sans connexion à l'eau :** Les éviers autonomes de Fricosmos sont équipés de systèmes de stockage d'eau et de pompes qui leur permettent de fonctionner sans être connectés au réseau d'eau. Cela est particulièrement utile dans les endroits où il n'y a pas d'accès à une source d'eau à proximité ou dans les situations d'urgence.

**Hygiène et sécurité :** Ces éviers en acier inoxydable facilitent le nettoyage et la désinfection. De plus, ils sont facultativement équipés de distributeurs de savon et de papier, ce qui favorise une bonne hygiène des mains et réduit la propagation des maladies.

**Économie de temps et de ressources :** En disposant d'un évier autonome de Fricosmos, il n'est pas nécessaire de parcourir de longues distances pour se laver les mains. Cela permet d'économiser du temps et des ressources en évitant les déplacements inutiles et en favorisant une bonne hygiène à l'endroit où cela est nécessaire.

**Conformité aux réglementations :** Ces éviers respectent les réglementations sanitaires en vigueur, ce qui est particulièrement important dans les environnements commerciaux et de soins de santé. Cela garantit le respect des normes d'hygiène et maintient un environnement sûr pour les utilisateurs.

Ce ne sont là que quelques-uns des avantages d'un évier autonome de Fricosmos. Il est important de noter que les caractéristiques et les spécifications peuvent varier en fonction du modèle spécifique que vous choisissez. Si vous envisagez d'acquérir un évier autonome, je vous recommande de vous renseigner davantage sur les produits Fricosmos et leurs caractéristiques pour vous assurer qu'ils répondent à vos besoins spécifiques.

# LAVAMANOS AUTÓNOMOS

SELF-CONTAINED WASHBASINS / LAVE-MAINS AUTONOMES



**Rebosadero**  
Overflow  
Déversoir



**Caño giratorio en  
acero inoxidable**  
Stainless steel  
rotating spout  
Jet giratoire en acier  
inoxydable



**Esquinas  
redondeadas**  
Rounded corners  
Coins arrondis



**Reborde anti  
derrames**  
Anti-spill flange  
Bride anti-déversement



**Papelera integrada**  
Waste bin integrated  
Corbeille a papier  
intégrée



**Trampilla  
basculante**  
Swing lid  
Trappe basculante



**Pedal hidráulico**  
Hydraulic pedal  
Pédale hydraulique



Video



Lavamanos autónomos  
Self-contained washbasins  
Lave-mains autonomes

061428

061430

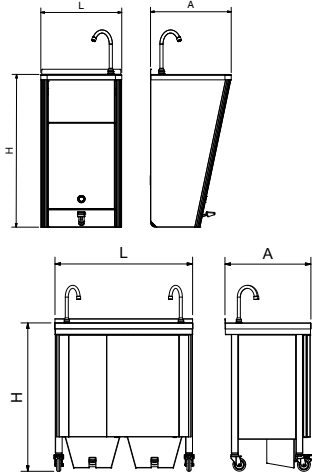

Tipo de accionamiento Operation Accionnement	Pulsador hidráulico tipo pedal Pedal type hydraulic push button Poussoir hydraulique type pédale	Pulsador hidráulico tipo bomba Pump type hydraulic push button Poussoir hydraulique type pompe
Caudal Flow Débit	2 l/min	1 l/min
Requiere toma eléctrica Electrical outlet required Requiert prise d'électricité	-----	-----
Agua fría Cold water Eau froide	<input checked="" type="checkbox"/>	<input checked="" type="checkbox"/>
Agua caliente Hot water Eau chaude	Opcional Optional Optionnel	Opcional Optional Optionnel
Potencia Power Puissance	-----	-----
Caño giratorio Rotating spout Bec tournant de robinet commande	<input checked="" type="checkbox"/>	<input checked="" type="checkbox"/>
Conjunto peto, jabonera y dispensador Raised backsplash for mobile hand washbasin Dossieret inox postérieur pour lave-mains autonome	Opcional Optional Optionnel	Opcional Optional Optionnel
Papelera integrada Waste bin integrated Corbeille a papier intégrée	<input checked="" type="checkbox"/>	<input checked="" type="checkbox"/>
Ruedas Wheels Rouelles	2	2
L	450 mm	450 mm
A	450 mm	450 mm
H	850 mm	850 mm
Peso / Weight / Poids	15,00 Kg.	15,00 Kg.
Unidades por palet Units per pallet Unités par palette	8	8
Tipo de cubeta Type of bowl Type d'évier	Redonda con reborde Rounded with anti-drip edge Arrondi avec rebord	Redonda con reborde Rounded with anti-drip edge Arrondi avec rebord
Dimensiones cubeta Bowl dimensions Dimensions évier	Ø 390 mm	Ø 390 mm
Profundidad cubeta Bowl depth Profondeur évier	150 mm	150 mm
Bidones incluidos Plastic tanks included Bidons inclus	2	2
Capacidad agua limpia Clean water tank capacity Capacité eau propre	15 l.	10 l.
Capacidad agua sucia Dirty water tank capacity Capacité eau sale	15 l.	10 l.

572,00€

538,00€



061474

061464

061468

061466



2x Pulsador hidráulico tipo pedal  
Pedal type hydraulic push button  
Poussoir hydraulique type pédale

Sensor sin contacto  
Non-contact sensor  
Capteur sans contact

Pulsador accionamiento automático  
Automatic operation push button  
Poussoir accionnement automatique

2x Pulsador accionamiento automático  
Automatic operation push button  
Poussoir accionnement automatique

2 x 2 l/min

2 l/min

2 l/min

2 l/min

-----

Batería  
Battery  
Batterie

Batería  
Battery  
Batterie



Opcional  
Optional  
Optionnel

Opcional  
Optional  
Optionnel

Opcional  
Optional  
Optionnel



-----

12 V.

12 V. &amp; 220v. - 50-60Hz.

3500W - 230v. - 50Hz.



-----



-----

Opcional  
Optional  
Optionnel

Opcional  
Optional  
Optionnel

Opcional  
Optional  
Optionnel

-----



4

2

2

2

800 mm

450 mm

450 mm

450 mm

500 mm

450 mm

450 mm

450 mm

850 mm

850 mm

850 mm

850 mm

24,00 Kg.

15,00 Kg.

17,00 Kg.

18,00 Kg.

2

8

8

8

Rectangular con reborde  
Rectangular with anti-drip edge  
Rectangulaire avec rebord

Redonda con reborde  
Rounded with anti-drip edge  
Arrondi avec rebord

Redonda con reborde  
Rounded with anti-drip edge  
Arrondi avec rebord

Redonda con reborde  
Rounded with anti-drip edge  
Arrondi avec rebord

340x370 mm

Ø 390 mm

Ø 390 mm

Ø 390 mm

150 mm

150 mm

150 mm

150 mm

4

2

2

2

2 x 20 l.

15 l.

15 l.

10 l.

2 x 20 l.

15 l.

15 l.

10 l.

1.512,00€

713,00€

705,00€

1.177,00€

## Accesorios para lavamanos portátiles autónomos

Mobile and autonomous hand wash basins accessories  
Accessoires pour lave-mains sur pied autonome et portable



Opción de agua caliente para lavamanos autónomo Optional hot water for mobile washbasin Eau chaude optionnelle pour lave-mains portables						
	Potencia Power Puissance	Tensión Voltage Tension	Frecuencia Frequency Fréquence	Modelos Models Modèles		€
	34°C	100 W	220 V	50/60 Hz	061428 061430 061468 061474	061450 <b>48,00</b>
	34°C	100 W	12 V		061428 061430 061468 061474	061452 <b>167,00</b>
	34°C	200 W	220 V	50/60 Hz	061428 061430 061468 061474	061454 <b>91,00</b>
	50°C	3.500 W	230 V	50/60 Hz	061468	461456 <b>265,00</b>

Kit para temperatura ambiente inferior a 15 °C.  
Accessory for room temperature below 15 °C.  
Kit pour température ambiante moins de 15 °C.

## Conjunto peto, jabonera y dispensador tissues para lavamanos autónomo

Backsplash, soap dispenser and tissues dispenser set for mobile hand washbasin  
Dossieret inox postérieur pour lave-mains autonome

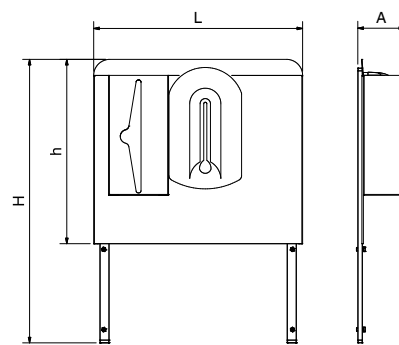

	L	A	H	h	Kg		€
	453	110	600	400	3	060610	<b>127,00</b>
	453	110	600	400	3,5	060614	<b>110,00</b>

## Kit de conexión a red de agua para lavamanos autónomo

Water mains connection kit for mobile washbasin  
Kit de raccordement au réseau d'eau pour lave-mains autonome



L	A	H	Gr		€
230	192	430	400	061456	<b>47,00</b>

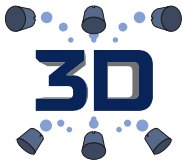

**Características:**

El novedoso sistema dispone de numerosos puntos de salida de agua mezclada distribuidos por la superficie del seno y orientados de tal manera que posibilita un óptimo y homogéneo lavado de manos sin prácticamente necesidad de moverlas, a la vez que se produce un ahorro considerable en el consumo de agua.

Asimismo, incorpora petos anti-salpicaduras soldados en la parte trasera y en los laterales de manera semi-envolvente, así como un dispensador de jabón automático, para garantizar un uso sin contacto. Todo ello se sirve montado de fábrica.

**Characteristics:**

This innovative system has several mixed water outlet points distributed over the surface of the basin and oriented in such a way that it allows an optimal and homogeneous hand washing with literally no need to move them and with great savings in water consumption simultaneously. In addition, it has rear and lateral welded backsplashes in a wraparound design, as well as an automatic soap dispenser for a totally hands-free use. Everything is factory assembled.

**Caractéristiques:**

Le nouveau système dispose de nombreux points de sortie d'eau mélangée répartis sur la surface de l'évier et orientés de manière à permettre un lavage des mains optimal et homogène sans pratiquement avoir besoin de les déplacer, tout en réalisant en même temps des économies considérables dans la consommation de l'eau.

De même, il intègre des dossierés anti-éclaboussures soudés au dos et sur les côtés de manière semi-enveloppante, ainsi qu'un distributeur de savon automatique, pour garantir une utilisation sans contact. Tout cela se livre monté en usine.

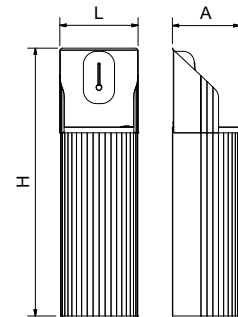
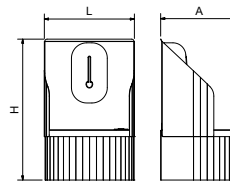

<b>Tipo de accionamiento</b> Operation Accionnement	<b>Sensor sin contacto</b> Non-contact sensor Capteur sans contact	<b>Sensor sin contacto</b> Non-contact sensor Capteur sans contact
<b>Caudal</b> Flow Débit	14 l/min	14 l/min
<b>Tipo de agua</b> Type of water Type d'eau	<b>Mezclada</b> Mixed Mélangée	<b>Mezclada</b> Mixed Mélangée
<b>L</b>	352 mm	352 mm
<b>A</b>	303 mm	303 mm
<b>H</b>	551 mm	1.205 mm
<b>Peso / Weight / Poids</b>	5,20 Kg.	9,50 Kg.
<b>Unidades por palet</b> Units per pallet Unités par palette	18	6
<b>Tipo de cubeta</b> Type of bowl Type d'évier	<b>Redonda con reborde</b> Rounded with anti-drip edge Arrondi avec rebord	<b>Redonda con reborde</b> Rounded with anti-drip edge Arrondi avec rebord
<b>Dimensiones cubeta</b> Bowl dimensions Dimensions évier	Ø 260 mm	Ø 260 mm
<b>Profundidad cubeta</b> Bowl depth Profondeur évier	115 mm	115 mm
<b>Funcionamiento grifo</b> Tap operation Opération de robinet	4x  AA	4x  AA

**563,00€**

**673,00€**

**Conjunto lavamanos y fregadero mural**  
 Double bowl wall-mounted hand wash basin-sink  
 Évier lave-mains suspendu à deux bacs



Provisto de mezclador antirretorno  
 Supplied with non-return mixing valve  
 Munies de valve antiretour mélangeuse

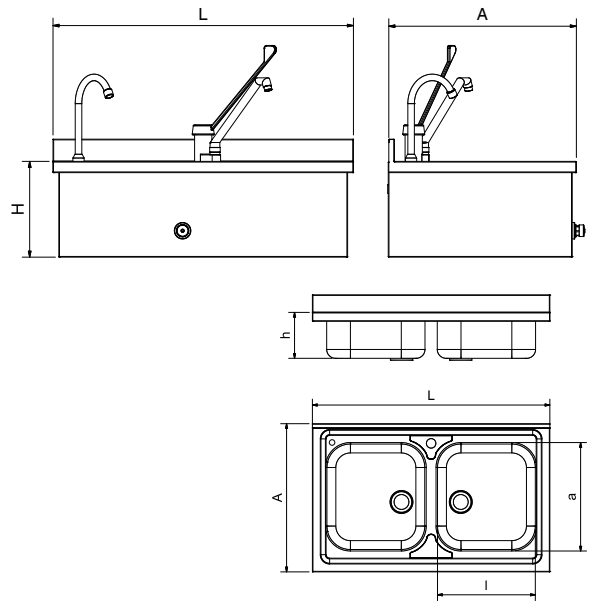

L	A	H	I	a	h	Kg	Barcode	€
800	500	255	330	360	120	12	054202	<b>559,00</b>

**Conjunto lavamanos y fregadero mural XS**  
 Double tank wall-mounted hand wash basin-sink XS model  
 Évier lave-mains suspendu à deux bacs XS

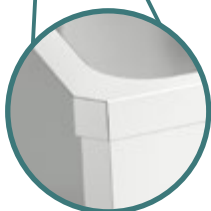

Provisto de mezclador antirretorno  
 Supplied with non-return mixing valve  
 Munies de valve antiretour mélangeuse

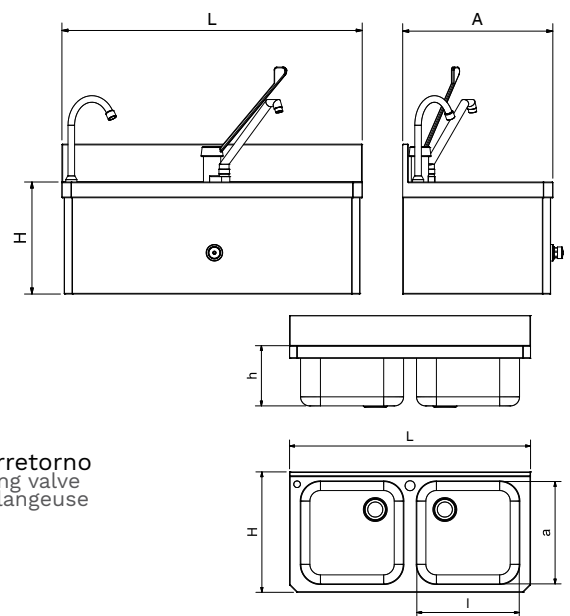

L	A	H	I	a	h	Kg	Barcode	€
800	400	300	340	340	200	15,5	054204	<b>758,00</b>

## Lavamanos mural colectivo de rodilla agua fría y caliente

Knee-operated hot and cold water wall-mounted collective washbasin  
Lave-main mural collectif à actionnement par genou eau froide et chaude



062020



55,00



412

Espejo Inox  
Stainless steel mirror  
Miroir inox



065004



661,00



409

Urinario inox  
Stainless steel urinal  
Urinoir inox



Provisto de mezclador antirretorno  
Supplied with non-return mixing valve  
Munies de valve antiretour mélangeuse

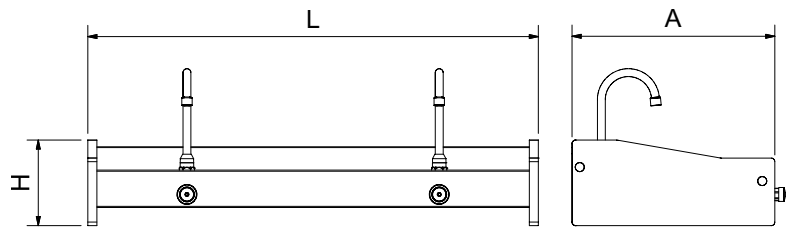

L	A	H	⌣	Kg	Barcode	€
1.000	450	190	2	12	061436	<b>467,00</b>
1.500	450	190	3	17	061438	<b>625,00</b>
2.000	450	190	4	22	061440	<b>743,00</b>

## Lavamanos mural colectivo

Wall-mounted collective washbasin  
Lave-main mural collectif



Sin accesorios ni taladros.  
Without accessories or drills  
Sans accessoires ni poinçonnages

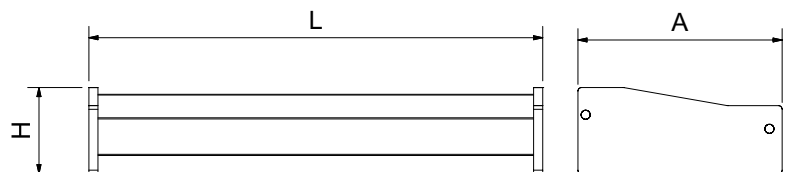

241

Configure este lavamanos incorporando la grifería que mas se ajuste a sus necesidades.  
You can form this washbasin by incorporating the taps that best suit your needs.  
Vous pouvez former ce lave-mains en intégrant les robinets qui conviennent le mieux à vos besoins.

L	A	H	Kg	Barcode	€
1.000	450	190	10	061442	<b>385,00</b>
1.500	450	190	14	061444	<b>465,00</b>
2.000	450	190	18	061446	<b>527,00</b>

## Pie inox para lavamanos mural colectivo

Stainless steel pedestal for collective hand washbasins  
Pied inox pour lave-mains collectif



### Características principales:

Este producto convierte un lavamanos mural colectivo en un lavamanos con pie. Mejora el aspecto al esconder todas las conexiones detrás de los pies. Aumenta la estabilidad. Fabricado enteramente en acero inoxidable.

### Main characteristics:

This accessory converts our wall-mounted collective washbasins in standing models. It hides all the connections behind the supports, for a better looking. It increases the stability. Made entirely of stainless steel.

### Caractéristiques principales:

Ce produit transforme nos lave-main mural collectif dans modèles sur pieds. Il cache toutes les connexions derrière les pieds, pour une plus belle apparence. Il augmente la stabilité. Fabriqué entièrement en acier inoxydable.

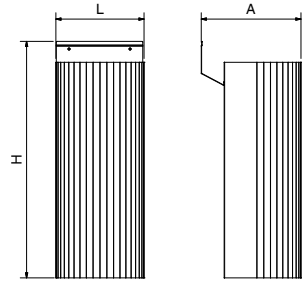

L	A	H	Kg	Barcode	€
317	392	930	5,50	061434	159,00

## Lavamanos quirúrgico mural con grifería

Hand washbasin for operating room with taps  
Lave-mains chirurgical mural avec robinet



### Características principales:

Fabricado en acero inoxidable, este lavamanos quirúrgico está especialmente diseñado para que dos usuarios simultáneos puedan lavarse las manos aplicando la técnica de lavado de manos quirúrgico. Incorpora un peto trasero de 400 mm de altura y una cubeta de gran profundidad. Este modelo incluye dos grifos 463208 de accionamiento a codo, para evitar el contacto con las manos.

\*El peto no incluye los taladros ya que en cada quirófano se necesitarán a una altura y distancia diferentes, en función de las tomas de agua disponibles. Asimismo también permitirá elegir otros grifos si se desea.

### Main characteristics:

Made of stainless steel, this hand washbasin for operating room is specially designed to allow two users washing their hands simultaneously using the surgical hand washing technique. It incorporates a rear backsplash of 400 mm high and a deep tank. This model includes two elbow-operated taps 463208, to avoid hand contact.

\*The backsplash is provided without holes since every operating room has their own water outlets at a different height and distance. It will also allow you to choose other faucets if desired.

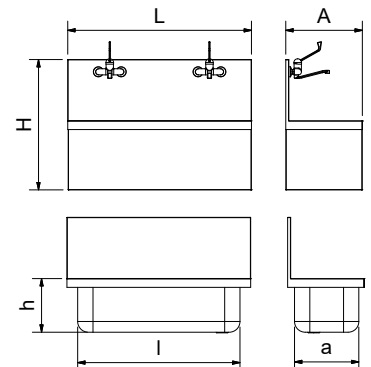

### Caractéristiques principales:

Fabriqué en acier inoxydable, ce lave-mains chirurgical est spécialement conçu pour que deux utilisateurs simultanés puissent se laver les mains en utilisant la technique de lavage chirurgical des mains. Il intègre un dossier arrière de 400 mm de hauteur et une cuve profonde. Ce modèle comprend deux robinets 463208 avec actionnement à coude, pour éviter tout contact avec les mains.

\*Le dossier ne comprend pas de perçage car dans chaque salle d'opération, il sera nécessaire à une hauteur et une distance différentes, en fonction des prises d'eau disponibles. Il vous permettra également de choisir d'autres robinets si vous le souhaitez.

L	A	H	l	a	h	Kg	Barcode	€
1.200	500	850	1.060	420	350	13,75	061478	1.386,00

## Lavamanos quirúrgico doble con grifos electrónicos

Double surgical sink with electronic taps

Lave-mains chirurgical double avec robinets électroniques



### Características principales:

Fabricado en acero inoxidable, este lavamanos está especialmente diseñado para quirófanos. Apto para dos usuarios simultáneos, ya que incluye 2 grifos electrónicos a pared 460808. Su activación mediante sensor de proximidad favorece el lavado de manos sin contacto, evitando así contaminación cruzada. El peto no lleva taladros para que cada instalador lo pueda adaptar a la altura de las tomas de agua, teniendo en cuenta que los grifos deberán permitir que las manos estén por encima de los codos.

### Características principales:

Fabricado en acero inoxidable, este lavamanos está especialmente diseñado para quirófanos.

Apto para dos usuarios simultáneos, ya que incluye 2 grifos electrónicos a pared 460808. Su activación mediante sensor de proximidad favorece el lavado de manos sin contacto, evitando así contaminación cruzada.

El peto no lleva taladros para que cada instalador lo pueda adaptar a la altura de las tomas de agua, teniendo en cuenta que los grifos deberán permitir que las manos estén por encima de los codos.



Funcionamiento a pilas  
Batteries functioning  
Fonctionnement a piles

### Main characteristics:

Made of stainless steel, this sink is specially designed for operating rooms.

Suitable for two simultaneous users, as it includes 2 460808 electronic wall-mounted taps. Proximity sensor activation for a contactless hand washing, to avoid cross contamination.

The backsplash has no holes so that it can be adapted to the desired height in accordance with the water inlets, taking into account that the taps must allow the hands to be above the elbows.

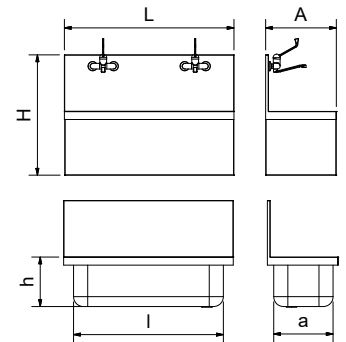

L	A	H	I	a	h	Kg	Barcode	€
1.200	500	850	1.060	420	350	13,75	061476	1.691,00

## Lavamanos quirúrgico con grifos mixtos

Surgical sink with mixed taps

Lave-mains chirurgical avec robinets mixtes



### Características principales:

Fabricado en acero inoxidable, este lavamanos está especialmente diseñado para quirófanos. Apto para dos usuarios simultáneos, ya que incluye 2 grifos: uno electrónico (460808) y otro monomando de activación con codo (463218). Ambos grifos permiten su activación sin contacto con las manos, con lo que favorece la higiene sin contaminación cruzada. El peto no lleva taladros para que cada instalador lo pueda adaptar a la altura de las tomas de agua, teniendo en cuenta que los grifos deberán permitir que las manos estén por encima de los codos.

### Características principales:

Fabricado en acero inoxidable, este lavamanos está especialmente diseñado para quirófanos.

Apto para dos usuarios simultáneos, ya que incluye 2 grifos: uno electrónico (460808) y otro monomando de activación con codo (463218). Ambos grifos permiten su activación sin contacto con las manos, con lo que favorece la higiene sin contaminación cruzada.

El peto no lleva taladros para que cada instalador lo pueda adaptar a la altura de las tomas de agua, teniendo en cuenta que los grifos deberán permitir que las manos estén por encima de los codos.



Funcionamiento a pilas  
Batteries functioning  
Fonctionnement a piles

### Main characteristics:

Made of stainless steel, this sink is specially designed for operating rooms.

Suitable for two simultaneous users, as it includes 2 taps: an electronically-operated one (460808) and an elbow operated one (463218). Both of them allow a hygienic hands-free activation to avoid cross contamination.

The backsplash has no holes so that it can be adapted to the desired height in accordance with the water inlets, taking into account that the taps must allow the hands to be above the elbows.

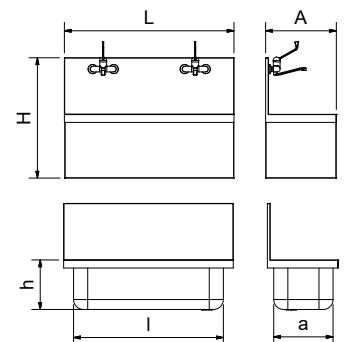

L	A	H	I	a	h	Kg	Barcode	€
1.200	500	850	1.060	420	350	13,75	061480	1.691,00

## Calentador de agua instantáneo

Instant water heater  
Chauffe-eau instantané



### Características principales:

Diseñado para proporcionar agua caliente a un solo lavamanos. Calienta el agua mediante su paso por un serpentín eléctrico.

Temperatura de salida del agua de 35° a 50°

Leaving water temperature 35° - 50°  
Température de sortie d'eau 35° - 50°

### Main characteristics:

It is designed to provide instantaneous hot water to one hand washbasin, by means of an electric coil.

### Caractéristiques principales:

Il est conçu pour fournir de l'eau chaude instantanée au lave-main, au moyen d'une bobine électrique

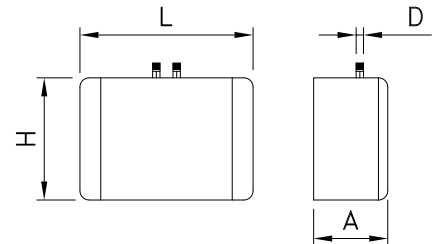

L	A	H	D			Potencia Power Puissance	Tensión Voltage Tension	Frecuencia Frequency Fréquence			€
165	70	200	3/8"	50°C	2,0	3.500 W	230 V	50/60 Hz.	1,10	461456	<b>265,00</b>

## Repuestos y accesorios para lavamanos









Spare parts for hand wash basins  
Pièces de rechange pour lave-mains

	Descripción Description Description	Modelo Model Model			€
	Pedal de un agua M-M de 1/2" M-M 1/2" single inlet water pedal Pédale à une eau M-M d'1/2"		425	460602	<b>58,00</b>
	Pedal mezclador de agua fría y caliente M-M-M de 1/2" M-M-M 1/2" hot and cold-water mixer pedal Pédale mélangeuse eau froide et eau chaude M-M-M d'1/2"		770	460604	<b>113,00</b>
	Pulsador no temporizado M-M de 1/2" M-M 1/2" self-closing momentary push button Bouton-poussoir non temporisé M-M d'1/2"		390	460404	<b>48,00</b>
	Pulsador inoxidable temporizado M-M de 1/2" Stainless steel push button - timer valve M-M de 1/2" Bouton poussoir inox temporisé 1/2" M-M		390	460432	<b>66,00</b>
	Kit de juntas para pulsador no temporizado 460404 Gasket kit for push button not timer 460404 Kit de joints pour bouton-poussoir non temporisé 460404		5	460450	<b>6,00</b>
	Grifo de palanca un agua M-M de 1/2" M-M 1/2" knee-operated lever Robinet à levier M-M d'1/2"		1.350	463802	<b>115,00</b>















## Repuestos y accesorios para lavamanos

Spare parts for hand wash basins  
Pièces de rechange pour lave-mains

	Descripción Description Description	Modelo Model Model				
	Caño fijo 1/2" Fixed spout 1/2" Jet fixe 1/2"	Fijo Fixed Fix	420	461002	<b>55,00</b>	
	Caño giratorio 1/2" Rotating spout 1/2" Jet giratoire 1/2"	Giratorio Rotating Giratoire	250	461008	<b>42,00</b>	
	Caño giratorio extra bajo 1/2" Extra low rotating spout 1/2" Jet giratoire extra bas 1/2"	Giratorio Rotating Giratoire	280	461010	<b>47,00</b>	
	Grifo sobremesa electrónico Electronically-operated faucet, high spout Robinet électronique col de cygne haut	Fijo Fixed Fix	1.800	060804	<b>135,00</b>	
	Peto postizo para acoplar Detachable backsplash to be fitted to hand wash basin Dossieret amovible pour accopler au lave-mains	350x400 mm	1.120	060608	<b>27,00</b>	
		450x400 mm	1.450	060602	<b>28,00</b>	
	Peto postizo con taladros Backsplash with drills for hand washbasin Dossieret perforé pour lave-mains		450x400 mm	1.450	060606	<b>29,00</b>
	Peto postizo de esquina Corner backsplash Dossieret d'angle		350+350x400 mm	2.300	060612	<b>55,00</b>
	Peto postizo lateral reversible anti salpicaduras Detachable and reversible sidesplash Dossieret postiche latéral réversible anti-éclaboussures			415	060630	<b>25,00</b>
	Peto postizo envolvente anti salpicaduras Detachable anti-splash screen Dossieret postiche enveloppant anti-éclaboussures	350 mm	1.270	060632	<b>29,00</b>	
		450 mm	1.600	060634	<b>35,00</b>	









## Repuestos y accesorios para lavamanos

Spare parts for hand wash basins  
Pièces de rechange pour lave-mains

	Descripción Description Description	Modelo Model Model			
	<b>Papelera modelo Design (lavamanos integral mural)</b> Design model wastepaper bin (wall mounted integral hand wash basins) Corbeille à papier modèle Design (lavemains intégral mural)				
					
		2.300	080608	<b>77,00</b>	
	<b>Papelera-dispensador de papel</b> Paper bags dispenser Distributeur de sacs en papier				
		2.000	080424	<b>64,00</b>	
	<b>Papelera</b> Wastepaper bin Corbeille à papiers				
		2.200	080602	<b>59,00</b>	
	<b>Latiguillos flexibles en malla de acero inoxidable H-H de 1/2"</b> H-H 1/2" stainless-steel flexible hoses Flexibles en maille d'acier inoxydable H-H d'1/2"	400 mm	100	461202	<b>5,25</b>
		600 mm	120	461206	<b>6,30</b>
		900 mm	200	461212	<b>8,40</b>
		1.200 mm	240	461214	<b>7,88</b>
		1.500 mm	345	461216	<b>9,45</b>
	<b>Válvula con rebosadero para lavamanos de 450x450 mm</b> Drain valve with overflow for 450x450 mm hand wash basins. Valvule de drainage avec déversoir pour lave-mains de 450x450 mm				
		145	454202	<b>9,00</b>	
	<b>Válvula de PVC con rebosadero, acabado cromado 1 1/2"</b> Drain valve in PVC with overflow, chrome finished 1 1/2" Valvule de drainage avec déversoir en PVC, finition chromé 1 1/2"				
		150	454205	<b>43,00</b>	
	<b>Rebosadero para lavamanos 061402, 061404 y 061448</b> Overflow for 061402, 061404 and 061448 hand wash basins Déversoir pour lave-mains 061402, 061404 et 061448				
		2	454206	<b>6,30</b>	
	<b>Desagüe flexible para lavamanos autónomo 1 1/2"</b> Flexible drain hose for autonomous wash basin 1 1/2" Tuyau de drainage flexible pour lave main autonome 1 1/2"				
		125	454260	<b>5,25</b>	
	<b>Sifón de desagüe para lavamanos 1 1/2"</b> U-bended drainpipe for hand wash basins 1 1/2" Siphon de drainage pour lave-mains 1 1/2"				
		169	454402	<b>10,50</b>	





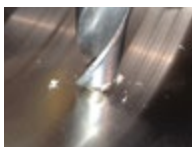



## Repuestos y accesorios para lavamanos

Spare parts for hand wash basins  
Pièces de rechange pour lave-mains

	Descripción Description Description			
	Sifón de PVC acabado cromado 1 1/2" U-bended drainpipe in PVC, chrome finished 1 1/2" Siphon en PVC, finition chromé 1 1/2"	170	454408	<b>36,00</b>
	Sifón de latón cromado 1 1/2" U-bended drainpipe in chrome brass 1 1/2" Siphon en laiton chromé 1 1/2"	1.400	454404	<b>80,00</b>
	Bidón de 10 lts para lavamanos autónomo 10 litres water container for portable hand washbasins Bidon d'eau de 10 litres pour lave main autonome	360	461430	<b>15,00</b>
	Bidón apilable blanco 15L para fregadero autónomo White stackable Jerrycan 15L for portable sinks Bidon empilable blanc 15L pour plonge autonome	550	461428	<b>20,00</b>
	Bidón apilable translúcido 20 lts para fregadero autónomo 20 litres water container for portable sinks Bidon d'eau de 20 litres pour Plonge inox autonome	360	461426	<b>25,00</b>
	Bidón apilable blanco 25L para fregadero autónomo White stackable Jerrycan 25L for portable sinks Bidon empilable blanc 25L pour plonge autonome	1.200	461429	<b>27,00</b>
	Goma elástica para la sujeción de bolsas de basura en lavamanos Elastic strap for hand wash basins Tendeurs élastiques pour lave-mains	125	464406	<b>3,50</b>
	Rueda de plástico ø50x18 mm para lavamanos autónomo Plastic wheel ø50x18 mm for autonomous wash basin Roulette en plastic ø50x18 mm pour lave main autonome	25	485020	<b>4,30</b>
	Tapón cubre agujeros ø42mm Hole cover cap ø42mm Bouchon couvre trou ø42mm	16	454602	<b>8,40</b>
	Hacer agujero en fregadero o lavamanos Drill hole to sink Faire trou à plonge	056802		<b>33,00</b>

## Repuestos y accesorios para lavamanos

Spare parts for hand wash basins  
Pièces de rechange pour lave-mains

	Descripción Description Description			
	Válvula mezcladora termostática M-H-M de 1/2" M-H-M 1/2" thermostatic mixing valve Valve mélangeuse thermostatique M-H-M d'1/2"	620	461402	<b>97,00</b>
	Mezclador antiretorno M-H-M 1/2" M-F-M 1/2" no-return mixing valve Valve antiretour mélangeuse M-H-M d'1/2"	150	461604	<b>26,25</b>
	Válvula de esfera H-H de 1/2" F-F 1/2" valve Valve H-H d'1/2"	140	461404	<b>10,00</b>
	Válvula antiretorno H-H de 1/2" F-F 1/2" non-return valve Valve antiretour H-H d'1/2"	140	462202	<b>8,40</b>
	"T" mezcladora M-H-M de 1/2" M-F-M 1/2" "T" mixer "T" mélangeur M-H-M d'1/2"	80	461602	<b>7,00</b>
	Codo a 90° M-H de 1/2" M-F 1/2" 90° angle Coude à 90° M-H d'1/2"	80	461802	<b>3,15</b>
	Unión M-M de 1/2" M-M 1/2" union Jonction M-M d'1/2"	20	462002	<b>2,25</b>
	Dosificador de jabón encastrable 600 ml. Stainless steel soap dispenser to be embedded 600 ml. Doseur de savon en acier inoxydable pour adosser 600 ml.	580	460218	<b>79,00</b>



# FUENTES DE AGUA

DRINKING FOUNTAINS  
FONTAINE D'EAU

## NOVEDADES

NEWS  
NOUVEAUTÉS



207



207



210



211



212



214





## Fuentes de agua fría, caliente y del tiempo Futura

Drinking fountains Futura, for cold, hot and room temperature water  
Fontaines d'eau froide, chaude et à température ambiante Futura

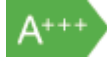

### Características principales:

La fuente de agua fría más compacta del mercado. Especial para espacios reducidos. Máxima ergonomía. Dispensador de vasos. Dispensador para llenar botellas y recipientes de grandes dimensiones. Dotada de filtro de agua de carbón activado 3M de 0,5 micras de serie. Certificado NSF y EN 1935/2004. Duración 4.000 litros aproximadamente. No lleva válvula de flotador para mayor higiene. Tecnología Silver para maximizar la higiene. Control del nivel de frío. Termostato interno. Funcionamiento súper silencioso. Compresor de 1/15 HP modo ahorro de energía. Soporta temperaturas ambiente de hasta 43°C. Entrada con conexión rápida de agua de 1/4". Panel de acero inoxidable fácilmente desmontable para facilitar el mantenimiento. Calentador de agua de 2.000 W. Tanque suplementario de agua caliente de 0,8 litros y 45 tazas/hora de capacidad y fabricado en acero inoxidable. Temperatura controlada mediante microprocesador para priorizar el ahorro de energía. Máxima temperatura 97°C. Fabricada en la Unión Europea. Los filtros se deberán cambiar cada 4.000 lts. o 6 meses. Lo que antes se dé.

\*Nota: La alimentación de agua de la fuente debe ser agua apta para el consumo humano (agua potable). En ningún caso el equipo adaptará o convertirá agua al consumo humano que no lo sea, ni antes ni después de pasar por el equipo.

### Main characteristics:

The smallest cold water drinking fountain, specially for reduced spaces. Superior ergonomics. Cup dispenser. Dispenser for filling bottles and large containers. Provided with 0.5 microns activated carbon water filter 3M for 4.000 liters approx. NSF and EN 1935/2004 certified. Without float valve for a maximum hygiene. Silver technology to maximize the hygiene. Cooling controlled. Internal thermostat. Smooth silent running. Energy saving compressor 1/15 HP. Resistant to environmental temperatures up to 43°C. Quick connector 1/4" for water inlet. Stainless steel panel easy to remove to facilitate the maintenance. Water heater 2.000 W. Additional container of 0,8 liters for hot water with capacity for 45 cups per hour. Made of stainless steel. Temperature controlled by microprocessor to prioritize the energy saving. Maximum temperature 97°C. Made in the European Union. The filters must be changed every 4.000 liters or 6 months. Whatever earlier comes.

\*Comments: the water supply must be suitable for human consumption (drinking water). Under no circumstance this device will convert or adapt non drinking water to suitable for human consumption, before or after bypassing through the device.

### Caractéristiques principales:

La fontaine d'eau froide de taille la plus réduite du marché. Spécialement conçu pour les espaces réduits. Ergonomie maximum. Distributeur de verres. Distributeur pour remplir bouteilles et récipients de grandes dimensions. Possède un filtre à charbon actif 3M de 0,5 microns de série. Certificat NSF et EN 1935/2004. Durée 4.000 litres environ. Ne contient pas de valve de flotteur pour une meilleure hygiène. Technologie Silver pour un maximum d'hygiène. Control du niveau de froid. Thermostat interne. Fonctionnement super silencieux. Compresseur de 1/15 HP en mode économie d'énergie. Supporte des températures ambiantes jusqu'à 43°C. Entrée avec connexion rapide d'eau de 1/4". Panneau en acier inoxydable facilement démontable pour faciliter la maintenance. Chauffe eau de 2.000 W. Réservoir supplémentaire d'eau chaude de 0,8 litres et 45 tasses par heures de capacité. Fabriqué en acier inoxydable. Température contrôlée à travers un microprocesseur pour privilégier l'économie d'énergie. Température maximum 97°C. Fabriquées dans l'Union Européenne. Les filtres doivent se changer chaque 4.000 lts ou tous les 6 mois. Des deux, la première situation qui se produise.

°C de entrada de agua	Refrigeración	°C Salida de agua	
°C inlet water	Refrigeration	°C Output	
°C eau d'entrée	Réfrigération	Water	
		°C Eau de sortie	
25 °C	-4 °C	21 °C	33
25 °C	-14 °C	11 °C	9

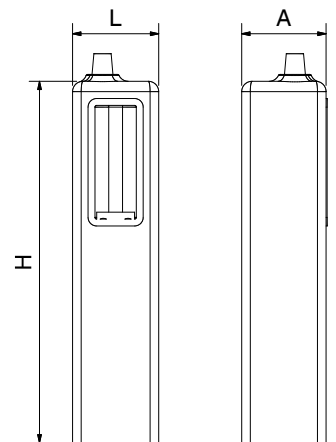

\* Note : l'alimentation d'eau de la fontaine doit être de l'eau appropriée à la consommation humaine (eau potable). En aucun cas le matériel s'adaptera ou convertira en eaux pour la consommation humaine, des eaux qui ne le sont pas, ni avant, ni après leur passage par le matériel.



L	A	H	Potencia Power Puissance	Tensión Voltage Tension	Frecuencia Frequency Fréquence	Kg	Barcode	€
			2.000 W			20	464202	1.199,00
250	175	1.060	50 W	220 V	50 Hz.	18	464204	899,00

**Fuente de agua fría Cold+ mural**  
Cold+ wall mounted water drinking fountain  
Fontaine d'eau fraîche Cold+ murale



**Características principales:**

Dotada de grifo llena-jarras.  
Control del nivel de frío. Termostato interno.  
Entrada de agua de 1/4".  
Panel de acero inoxidable fácilmente desmontable para el mantenimiento. Fabricada en la Unión Europea.

**Main characteristics:**

Provided of swan neck tap.  
Temperature level controlled by internal thermostat.  
Water inlet 1/4".  
Stainless steel front pannel, easily detachable to facilitate the maintenance.  
Made in EU.

**Caractéristiques principales:**

Avec robinet pour remplir les pichets.  
Control du niveau du froid. Thermostat interne.  
Entrée d'eau 1/4".  
Panneau en acier inox facilement démontable pour faciliter la maintenance.  
Fabriquée en U.E.

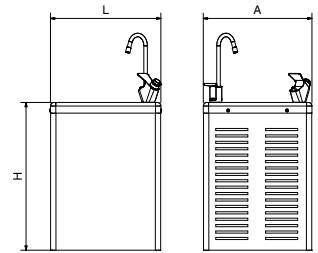

L	A	H	Potencia Power Puissance	Tensión Voltage Tension	Frecuencia Frequency Fréquence	Kg	Barcode	€
310	305	415	125 W	220 V	50 Hz.	17,0	464208	<b>957,00</b>

**Fuente de agua fría Cold+**  
Cold+ water drinking fountains  
Fontaine d'eau fraîche Cold+



**Características principales:**

Dotada de grifo llena-jarras.  
Control del nivel de frío. Termostato interno.  
Entrada de agua de 1/2".  
Panel de acero inoxidable fácilmente desmontable para el mantenimiento. Fabricada en la Unión Europea.

**Main characteristics:**

Provided of swan neck tap.  
Temperature level controlled by internal thermostat.  
Water inlet 1/2".  
Stainless steel front pannel, easily detachable to facilitate the maintenance.  
Made in EU.

**Caractéristiques principales:**

Avec robinet pour remplir les pichets.  
Control du niveau du froid. Thermostat interne.  
Entrée d'eau 1/2".  
Panneau en acier inox facilement démontable pour faciliter la maintenance.  
Fabriquée en U.E.

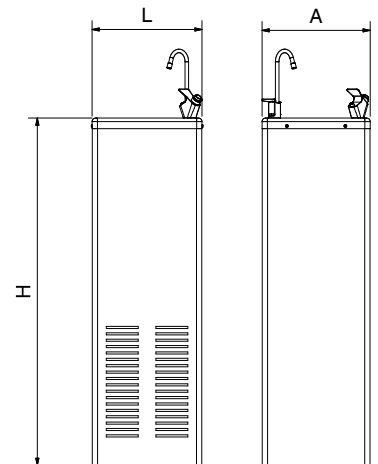

L	A	H	Potencia Power Puissance	Tensión Voltage Tension	Frecuencia Frequency Fréquence	Kg	Barcode	€
320	320	1.000	240 W	220 V	50 Hz.	25,0	464206	<b>1.041,00</b>



## Fuente de agua fría de columna

Cold water drinking column fountain  
Fontaine colonne d'eau fraîche



**Características principales:**  
Dotada de grifo llena-jarras.  
Control del nivel de frío.  
Termostato digital.  
12 l/h.

**Main characteristics:**  
Provided of swan neck tap.  
Temperature level controlled.  
Digital thermostat.  
12 l/h.

**Caractéristiques principales:**  
Avec robinet pour remplir les pichets.  
Control du niveau du froid.  
Thermostat digital.  
12 l/h.

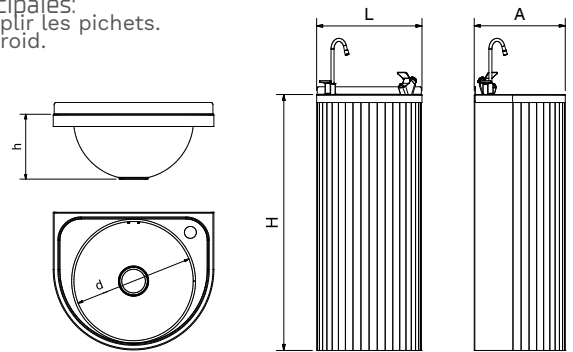

L	A	H	d	h	Potencia Power Puissance	Tensión Voltage Tension	Frecuencia Frequency Fréquence	Kg	Barcode	€
350	300	850	260	115	105 W	220-240 V	50 Hz.	17,0	064280	<b>803,00</b>



## Fuente de agua fría de columna con grifo electrónico sin contacto

Cold water drinking column fountain with contactless electronic faucet  
Fontaine colonne d'eau fraîche avec robinet électronique sans contact



Gracias a su grifo electrónico, su accionamiento se realiza sin contacto, lo cual ayudará a prevenir la contaminación cruzada.

Además, el grifo va temporizado por lo que los usuarios podrán utilizar la fuente con tranquilidad sin la necesidad de estar pulsando ningún botón.

Dotada de grifo llena-jarras.  
Control del nivel de frío.  
Termostato digital.  
12 l/h.  
Grifos electrónicos a pilas.

Thanks to its electronic battery-operated faucet (batteries not included), it will be activated hands-free, which will help to prevent cross contamination.

In addition, the faucet is timed and will switch off by itself, so that users can use the fountain in a carefree way.

Provided of swan neck tap.  
Temperature level controlled.  
Digital thermostat.  
12 l/h.  
Battery-operated electronic taps.

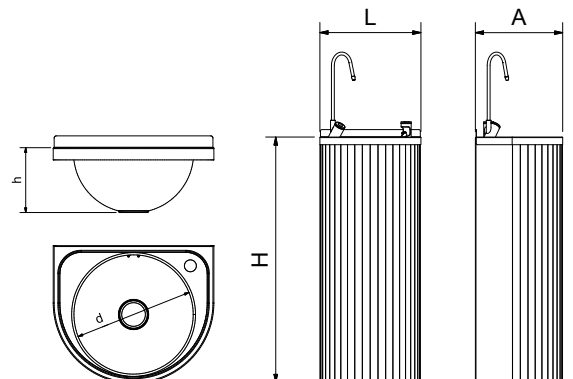

Grâce à son robinet électronique à pile (non inclus), son activation se fait sans contact, ce qui aidera à prévenir la contamination croisée.

De plus, le robinet est temporisé afin que les utilisateurs puissent utiliser la fontaine en toute tranquillité sans avoir besoin d'appuyer sur un bouton.

Avec robinet pour remplir les pichets.  
Control du niveau du froid.  
Thermostat digital.  
12 l/h.  
Robineets électroniques à piles.

L	A	H	d	h	Potencia Power Puissance	Tensión Voltage Tension	Frecuencia Frequency Fréquence	Kg	Barcode	€
350	300	850	260	115	105 W	220-240 V	50 Hz.	17,0	064282	<b>1.212,00</b>



## Fuentes murales refrigeradas de agua fría Cold+ a pedal

Wall-mounted refrigerated drinking water fountains Cold+ with pedal

Fontaines murale réfrigérée d'eau froide Cold+ à pédale

955020201



955020601

955020501

### Características

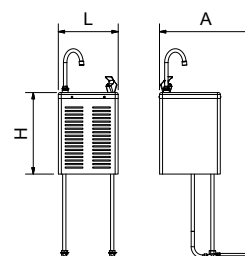
Characteristics  
Caractéristiques



Tipo de accionamiento de grifo Tap operation Accionnement du robinnet	Pedal Pedal Pédale	Pedal Pedal Pédale	Manual Manual Manuel
Tipo de accionamiento de llenajarras Bottle filler operation Accionnement du robinet de remplissage	Pedal Pedal Pédale	Manual Manual Manuel	Pedal Pedal Pédale
Tipo de agua Type of water Type d'eau			
L	310 mm	310 mm	310 mm
A	485 mm	485 mm	485 mm
H	415 mm	415 mm	415 mm
Peso / Weight / Poids	19,00 Kg.	18,00 Kg.	18,00 Kg.
Potencia Power Puissance	125 W	125 W	125 W
Tensión Voltage Tension	220 V	220 V	220 V
Frecuencia Frequency Fréquence	50 Hz.	50 Hz.	50 Hz.
	<b>1.231,00€</b>	<b>1.147,00€</b>	<b>1.141,00€</b>

## Fuentes refrigeradas de agua fría Cold+ a pedal

Free standing pedal operated refrigerated drinking fountains Cold+  
Fontaines réfrigérée eau froide Cold + à pédale



955020101

955020301

955020401

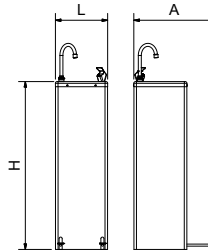
### Características Characteristics Caractéristiques



Tipo de accionamiento de grifo Tap operation Accionnement du robinnet	Pedal Pedal Pédale	Pedal Pedal Pédale	Manual Manual Manuel
Tipo de accionamiento de llenajarras Bottle filler operation Accionnement du robinet de remplissage	Pedal Pedal Pédale	Manual Manual Manuel	Pedal Pedal Pédale
Tipo de agua Type of water Type d'eau			
L	320 mm	320 mm	320 mm
A	485 mm	485 mm	485 mm
H	1.000 mm	1.000 mm	1.000 mm
Peso / Weight / Poids	27,00 Kg.	26,00 Kg.	26,00 Kg.
Potencia Power Puissance	240 W	240 W	240 W
Tensión Voltage Tension	220 V	220 V	220 V
Frecuencia Frequency Fréquence	50 Hz.	50 Hz.	50 Hz.
	<b>1.315,00€</b>	<b>1.231,00€</b>	<b>1.225,00€</b>



## Fuentes de columna sin refrigeración

Column fountains - Unrefrigerated  
Fontaines colonne - Sans réfrigération



064206

064212

064202

### Características Characteristics Caractéristiques

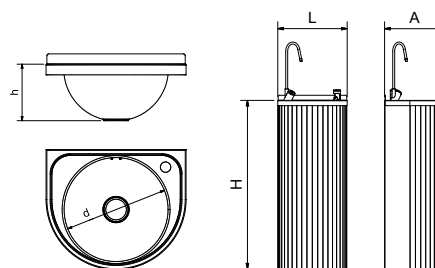

Tipo de accionamiento de grifo Tap operation Accionnement du robinnet	Manual Manual Manuel	Pedal Pedal Pédale	Sensor sin contacto Non-contact sensor Capteur sans contact
Tipo de accionamiento de llenajarras Bottle filler operation Accionnement du robinet de remplissage	Manual Manual Manuel	Manual Manual Manuel	Sensor sin contacto Non-contact sensor Capteur sans contact
L	350 mm	320 mm	320 mm
A	300 mm	320 mm	320 mm
H	850 mm	1.000 mm	1.000 mm
d	260 mm	260 mm	260 mm
h	115 mm	115 mm	115 mm
Peso / Weight / Poids	7,00 Kg.	7,30 Kg.	7,40 Kg.
Pilas Batteries Piles	-----	-----	4 x CR123
	<b>278,00€</b>	<b>368,00€</b>	<b>615,00€</b>

# Fuentes murales sin refrigeración

Wall-mounted fountains - Unrefrigerated  
Fontaines mural - Sans réfrigération



064204

064210

064208

064203

Características  
Characteristics  
Caractéristiques

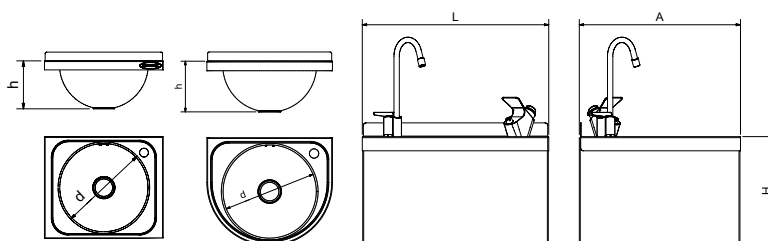

Tipo de accionamiento de grifo Tap operation Accionnement du robinnet	Manual Manual Manuel	Manual Manual Manuel	Manual Manual Manuel	Sensor sin contacto Non-contact sensor Capteur sans contact
Tipo de accionamiento de llenajarras Bottle filler operation Accionnement du robinet de remplissage	Manual Manual Manuel	Manual Manual Manuel	Manual Manual Manuel	Sensor sin contacto Non-contact sensor Capteur sans contact
L	350 mm	350 mm	350 mm	350 mm
A	300 mm	350 mm	300 mm	300 mm
H	200 mm	205 mm	200 mm	200 mm
d	260 mm	260 mm	260 mm	260 mm
h	115 mm	115 mm	115 mm	115 mm
Peso / Weight / Poids	2,08 Kg.	3,00 Kg.	6,00 Kg.	6,00 Kg.
Pilas Batteries Piles	-----	-----	-----	4 x CR123

**177,00€**

**335,00€**

**196,00€**

**495,00€**

## Enfriador de agua

Water cooler  
Refrigerateur d'eau

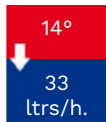

### Características:

Ideal para instalar agua fría en fregaderos, lavamanos, fuentes, etc.  
Tecnología para mejorar la higiene.  
Termostato para regular la temperatura del agua.  
Ahorro de energía gracias a su compresor de 1/4 Hp.  
CE  
Fabricado en la unión Europea.  
Envoltorio de acero pintado.  
Entrada y salida de agua de 1/2"

### Caractéristiques:

Ideal pour installer de l'eau froide sur des éviers, lavemains, fontaines, etc.  
Technologie pour améliorer l'hygiène.  
Thermostat pour régler la température de l'eau.  
Economie d'énergie grâce à son compresseur de 1/4 Hp.  
CE  
Fabriquée en Union Européenne  
Entrée et sortie d'eau grâce à une connexion 1/2".  
Acier peint.



### Characteristics:

Ideal for incorporating cool water in sink units, hand washbasins, drinking fountains, etc.  
Technology for a better hygiene  
Temperature adjustment by thermostat  
Energy saving through compressor - 1/4 Hp  
CE  
Made in UE  
Inlet and outlet connectors 1/2".  
Painted steel.

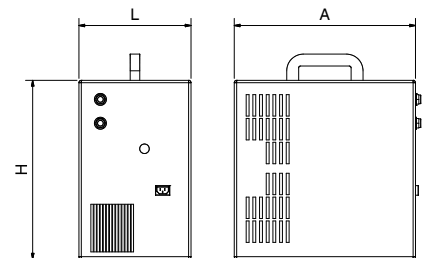

L	A	H	D	Potencia Power Puissance	Tensión Voltage Tension	Frecuencia Frequency Fréquence	Kg	Barcode	€
300	400	470	1/2"	230 W	220-240 V	50 Hz.	18,0	461460	<b>810,00</b>

## Sistema filtrador de agua

Water filter system  
Système filtrant de l'eau

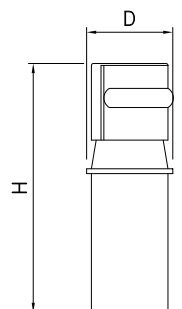

D	H	Kg	Barcode	€
80	290	1,00	064270	<b>168,00</b>

### Sistema filtrador de agua con grifo llenajarras

Water filter system with bottle filler tap

Système filtrant de l'eau avec robinet pour remplir des pichets

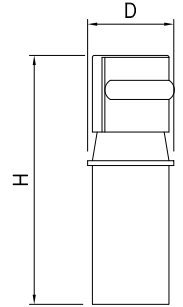

D	H	Kg	Barcode	€
80	290	1,30	064272	<b>176,00</b>



### Sistema filtrador de agua con caño





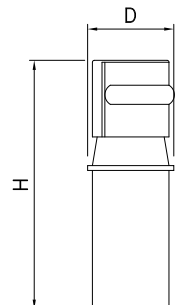





Water filter system with spout

Système filtrant de l'eau avec bec de cygne



D	H	Kg	Barcode	€
80	290	1,25	064274	<b>192,00</b>

**Accesorios para fuentes M 3/8"**  
 Spare parts for water fountains M 3/8"  
 Pièces de rechange pour fontaines d'eau M 3/8"

	Descripción Description Description	Gr	Barcode	€
	Grifo para fuente de agua sin pulsador Tap for drinking fountain without push-button Robinet pour fontaine sans bouton-poussoir	115	464248	<b>37,00</b>
	Grifo pulsador para fuente Push-button tap for fountain Robinet poussoir pour fontaine	125	464250	<b>26,00</b>
	Grifo electrónico inoxidable a pilas para fuente de agua 1/2" Electronic battery-powered faucet 1/2" in stainless steel for drinking fountain Robinet électronique à pile en acier inoxydable pour fontaine à eau 1/2"	460	464258	<b>234,00</b>
	Grifo llena-jarras Bottle filler Robinet pour remplir pots	130	464252	<b>24,00</b>
	Grifo llenajarras electrónico acero inoxidable para fuente de agua Stainless steel electronic bottle-filler tap for drinking fountain Robinet de remplissage de pichet électronique en acier inoxydable pour fontaine à eau	310	464254	<b>265,00</b>
	Filtro profesional de agua Brita Brita professional water filter Filtre à eau professionnel Brita	500	464224	<b>92,00</b>
	Filtro Bestmax para Futura fría y caliente Bestmax filter for Futura hot and cold water Filtre Bestmax pour Fontaine Futura froid et chaud	1.000	464220	<b>104,00</b>
	Filtro agua fría para Futura, Cold+ y Enfriador de agua Filter cold water for Futura, Cold+ and Water cooler Filtre eau froide pour fontaine Futura, Cold+ et Refroidisseur d'eau	230	464222	<b>79,00</b>
	Cabezal para filtro 3M y CARBA (Futura fría, Cold+ y Enfriador de agua) Head for filter 3M and CARBA (Futura cold, Cold+ and Water cooler) Tête pour filtre 3M et CARBA (Fontaine Futura froid, Cold+ et Refroidisseur d'eau)	100	464226	<b>97,00</b>
	Cabezal para filtro Bestmax (Futura fría y caliente) Head for filter Bestmax (Futura hot and cold water) Tête pour filtre Bestmax (Fontaine Futura froid et chaud)	1.500	464228	<b>97,00</b>





# FREGADEROS

SINKS  
ÉVIERS

## NOVEDADES

NEWS  
NOUVEAUTÉS



220



231



232



234



234



235



238



238



238



238



239



239



239



239



239

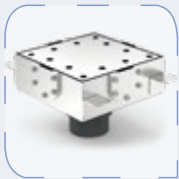

240



240



# Características de fabricación:

## Fregaderos

La amplia gama de fregaderos Fricosmos está concebida para adaptarse al máximo a las necesidades industriales, por lo que en nuestro catálogo encontrarán fregaderos colgantes, con soporte, con puertas, etc.

Totalmente fabricados en acero inoxidable, cuentan con bastidores de refuerzo bajo la encimera y entrepaño.

Estructura totalmente soldada que garantiza una mayor solidez frente a otros fregaderos con soportes desmontables. Patas construidas en tubo de 40x40 mm. Los modelos sin entrepaño llevan bastidor inferior de refuerzo.

Soporte desplazado en su parte trasera para salvar la curva sanitaria del suelo.

Pies regulables para favorecer la estabilidad, ya que se adaptan a cualquier desnivel del suelo.

Válvula de desagüe con tapón y rebosadero en modelos de fondo 500 mm. Los modelos industriales (fondo 600 y 700 mm.) se suministran con tubo rebosadero y válvula de desagüe.

Opcionalmente se pueden instalar los siguientes accesorios:



Taladro para acoplar grifo	201
Cajones	492
Ruedas	496
Válvula de descarga rápida	235
Esterilizador de cuchillos	370
Cubetas Gastronorm	435

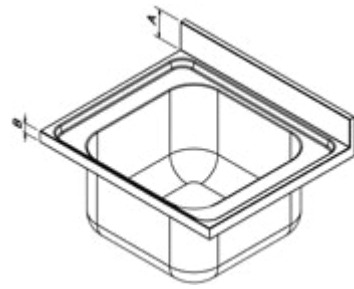

	A	B
<b>Serie 500</b> Model 500 Série 500	30	30
<b>Serie 550</b> Model 550 Série 550	100	60
<b>Serie 600 y 700</b> Model 600 & 700 Série 600 et 700	100	60



**Detalle de tubo rebosadero (Fregaderos de ancho 600 y 700 mm)**  
Overflow detail. (600 y 700 mm sinks)  
Détail de tube-déversoir (profondeur 600 et 700 mm)

## Manufacturing characteristics:

### Sink units

The wide range of sinks Fricosmos is conceived to fit in to the best industrial needs: wall-mounted sinks, with support, sliding or hinged doors...

Wholly made of stainless steel, they are fitted with undercounter and undershelf reinforcement frames.

Totally welded frame that guarantees a higher solidity in comparison to other detachable supports. Legs made of tube 40x40 mm. Models without shelf are reinforced with lower frame.

Frame support set back from the edge of the top to overcome the sanitary rounded corners.

Adjustable feet, for a better stability, since they can be adjusted to any floor unevenness.

Drain valve with plug and overflow in sink units of 500 mm depth. Industrial units (depth 600 and 700 mm.) are provided with pipe-overflow and drain valve.

Optionally, the following accessories can be installed:



Hole to couple tap	201
Drawers	492
Wheels	496
Quick drain valve	235
Knife-holder disinfectant	370
Gastronorm containers	435

### Detalle de rueda de acero inoxidable con freno acoplada a pata de fregadero.

Detail of wheel in stainless steel with brake fixed to leg.

Détail de roue en acier inoxydable avec frein installé dans pied.



**Detalle de pata con pie regulable.**  
Detail of adjustable feet.  
Détail de pie réglable.

## Caractéristiques de fabrication:

### Éviers

L'ample gamme d'éviers Fricosmos est conçue pour sa meilleure adaptation aux besoins industriels. Éviers suspendus, avec support, avec portes à deux battants, coulissantes...

Fabriqués entièrement en acier inoxydable, avec renfort sous l'étagère et tablette du dessous.

Châssis totalement soudé. Il permet d'achever plus de solidité par rapport à d'autres éviers avec supports démontables. Pieds construits en tube de 40x40 mm. Les modèles sans tablette-rayon ont du châssis inférieur de renforcement.

Support déplacé dans la partie postérieure pour permettre l'installation des conduits d'eau. En plus il est dessiné pour s'adapter parfaitement à la courbure sanitaire du sol.

Pieds réglables pour favoriser sa stabilité, puisqu'ils s'adaptent à n'importe quel sol.

Écoulement avec tampon et déversoir dans éviers avec 500 mm de profondeur. Les éviers industriels (profondeur 600 et 700 mm) sont fabriqués avec tube-déversoir et écoulement.

On peut installer les suivantes accessoires optionnels:



Trou pour accoupler un robinet	201
Tiroirs	492
Rouelles	496
Valve de rapide drainage	235
Porte-couteaux désinfecteur	370
Bacs Gastronorm	435

## Fregaderos para soldar

Sink units to weld  
Eleviers à souder



### Características de fabricación:

Fabricados en acero inoxidable. Las cubetas son de 1 mm de espesor y están acabadas en satinado scotch-brite. Válvula de desagüe con tapón y rebosadero en modelos redondos, los modelos industriales de 250, 300 y 350 mm se suministran con válvula de desagüe (sin rebosadero), tubo de rebosadero y tapón.

### Manufacturing characteristics:

Made in stainless steel. Tanks have 1 mm. thick and scotch brite matt finish. Drain valve with plug and overflow in rounded. Industrial models of 250, 300 and 350 mm. depth are provided with drain valve (without overflow), tube of overflow and plug.

### Caractéristiques de fabrication:

Fabriqués en acier inoxydable. Les bacs ont 1 mm d'épaisseur avec finition satiné scotch brite. Valvule d'écoulement avec bonde et déversoir dans modèles ronds. Les modèles industriels de 250, 300 et 350 mm son pourvus avec valvule d'écoulement (sans déversoir).

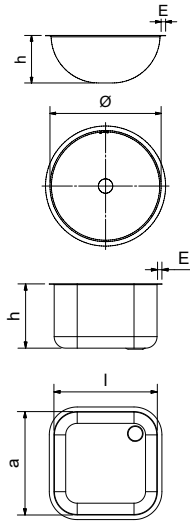

Ø	l	a	h	E		Kg		€
260			115	15	■	0,70	350624	<b>40,00</b>
390			150	20	■	1,40	350620	<b>65,00</b>
	370	340	145	20	■	2,60	350648	<b>111,00</b>
	400	400	250	20	■	3,71	454018	<b>100,00</b>
	400	400	300	20	■	4,10	454020	<b>110,00</b>
	500	500	300	20	■	5,40	454039	<b>145,00</b>
	500	500	350	20	■	5,63	454041	<b>215,00</b>
	600	450	300	20	■	5,45	454042	<b>170,00</b>
	600	450	300	20	■	5,45	454044	<b>170,00</b>
	600	450	350	20	■	6,11	454045	<b>229,00</b>
	600	450	350	20	■	6,11	454054	<b>229,00</b>
	600	500	300	20	■	5,95	454046	<b>180,00</b>
	600	500	300	20	■	5,95	454048	<b>197,00</b>
	600	500	350	20	■	6,51	454050	<b>183,00</b>
	600	500	350	20	■	6,51	454052	<b>183,00</b>
	800	420	350	20	■	9,51	454004	<b>465,00</b>
	800	420	350	20	■	9,51	454006	<b>465,00</b>
	1.060	420	350	20	■	10,51	454008	<b>530,00</b>
	1.060	420	350	20	■	10,51	454010	<b>530,00</b>

## Fregaderos para encastrar

Built-in sink series  
Eleviers modèle à intégrer

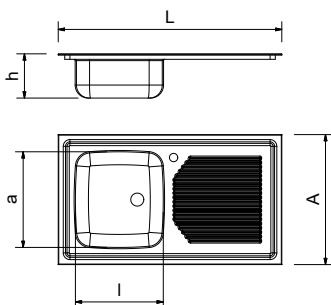

L	A	l	a	h		Kg		€
900	510	344	377	145	■	3,12	453202	<b>115,00</b>
860	500	340	370	170	■	2,50	453204	<b>132,00</b>
1.160	500	330	360	160	■	3,50	453206	<b>151,50</b>
1.160	500	330	360	160	■	3,50	453208	<b>151,50</b>

# Fregaderos

Sink units  
Éviers

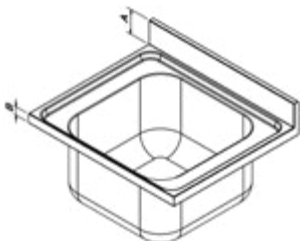

	A	B
<b>Serie 500</b> Model 500 Série 500	30	30
<b>Serie 550</b> Model 550 Série 550	100	60
<b>Serie 600 y 700</b> Model 600 & 700 Série 600 et 700	100	60



L	A	I	a	h	Kg	Barcode	€
450	450	370	340	170	1,85	450602	<b>80,00</b>
450	500	370	340	170	2,10	450604	<b>85,00</b>
600	500	500	400	150	2,95	450606	<b>94,00</b>
600	600	500	500	300	7,50	452200	<b>230,00</b>
700	600	500	400	250	8,35	452202	<b>255,00</b>
700	700	500	500	300	9,00	452602	<b>285,00</b>
800	600	500	400	250	9,00	452204	<b>275,00</b>
800	700	600	500	300	10,00	452604	<b>320,00</b>
1.000	600	860	420	350	14,50	452228	<b>575,00</b>
1.000	700	860	495	375	15,50	452628	<b>559,00</b>
1.200	600	1.060	420	350	16,50	452230	<b>625,00</b>
1.200	700	1.060	500	375	17,50	452630	<b>606,00</b>
1.500	600	1.160	420	600	19,50	453804	<b>912,00</b>
1.500	700	1.160	490	600	20,50	453806	<b>922,00</b>
2.000	600	800	420	600	24,50	453808	<b>1.577,00</b>
2.000	700	800	495	600	25,50	453810	<b>1.600,00</b>
1.300	700	800	495	370	14,00	453602	<b>624,00</b>
1.600	700	960	500	375	18,00	453606	<b>640,00</b>
1.300	700	800	495	370	14,00	453604	<b>624,00</b>
1.600	700	960	500	375	18,00	453608	<b>640,00</b>
800	500	370	340	120	3,10	450616	<b>101,00</b>
1.000	500	420	350	150	3,80	450628	<b>120,00</b>
1.000	550	340	340	200	8,50	452002	<b>304,00</b>
1.000	600	500	400	250	9,00	452206	<b>300,00</b>
1.000	700	500	500	300	10,00	452606	<b>425,00</b>
1.200	600	500	400	250	11,65	452210	<b>304,00</b>
1.200	700	400	500	250	12,65	452610	<b>345,00</b>
1.300	600	500	500	300	12,65	452214	<b>360,00</b>
1.300	700	500	500	300	12,50	452614	<b>340,00</b>
1.400	600	500	400	250	13,00	452218	<b>330,00</b>
1.400	700	600	500	300	14,00	452618	<b>360,00</b>
800	500	370	340	120	3,10	450618	<b>101,00</b>
1.000	500	420	350	150	3,80	450630	<b>120,00</b>
1.000	550	340	340	200	8,50	452004	<b>304,00</b>
1.000	600	500	400	250	9,00	452208	<b>300,00</b>
1.000	700	500	500	300	10,00	452608	<b>425,00</b>
1.200	600	500	400	250	11,65	452212	<b>304,00</b>
1.200	700	400	500	250	12,65	452612	<b>345,00</b>
1.300	600	500	500	300	12,65	452216	<b>360,00</b>
1.300	700	500	500	300	12,50	452616	<b>340,00</b>
1.400	600	500	400	250	13,00	452220	<b>330,00</b>
1.400	700	600	500	300	14,00	452620	<b>360,00</b>

**Fregaderos**  
Sink units  
Éviers

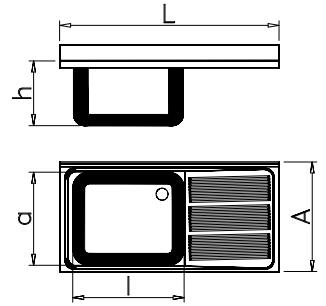

L	A	l	a	h	Kg	Barcode	€
800	500	340	370	150	3,80	450610	<b>158,50</b>
1.000	600	400	400	250	13,00	452222	<b>429,00</b>
1.000	700	400	500	250	14,00	452622	<b>558,00</b>
1.200	600	500	400	250	14,00	452224	<b>477,00</b>
1.200	700	500	500	300	15,00	452624	<b>500,00</b>
1.400	600	500	400	250	18,00	452226	<b>475,00</b>
1.400	700	600	500	300	19,00	452626	<b>539,00</b>
1.200	500	340	370	150	4,85	450636	<b>191,50</b>
1.400	550	400	400	250	14,50	452006	<b>450,00</b>
1.400	600	400	400	250	15,50	452232	<b>442,00</b>
1.400	700	400	500	250	16,50	452632	<b>420,00</b>
1.600	600	400	400	250	18,00	452246	<b>460,00</b>
1.600	700	400	500	250	19,00	452646	<b>592,00</b>
2.000	600	500	400	250	22,50	452240	<b>494,00</b>
2.000	700	600	500	300	23,50	452640	<b>590,00</b>
1.200	500	340	370	150	4,85	450638	<b>191,50</b>
1.400	550	400	400	250	14,50	452008	<b>450,00</b>
1.400	600	400	400	250	15,50	452234	<b>442,00</b>
1.400	700	400	500	250	16,50	452634	<b>420,00</b>
1.600	600	400	400	250	18,00	452248	<b>460,00</b>
1.600	700	400	500	250	19,00	452648	<b>592,00</b>
2.000	600	500	400	250	22,50	452242	<b>494,00</b>
2.000	700	600	500	300	23,50	452642	<b>590,00</b>
2.000	600	400	400	250	22,50	452244	<b>494,00</b>
2.000	700	400	500	250	23,50	452644	<b>525,00</b>
1.800	600	500	400	250	23,00	452250	<b>913,00</b>
1.800	700	400	500	300	25,00	452650	<b>720,00</b>



## Escurridor de platos y vasos en acero inoxidable

Stainless steel drainer for glasses and dishes

Égouttoir en acier inoxydable pour assiettes et verres



**N**ovedad  
New  
Products

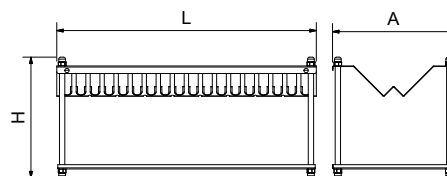

L	A	H	✓	Kg	Barcode	€
484	228	225	18	1,78	051602	<b>48,00</b>
955	228	225	36	3,25	051604	<b>75,00</b>

## Escurridor mural para utensilios de cocina

Wall drainer for kitchen utensils

Égouttoir mural pour ustensiles de cuisine



Diseñado para ser colgado encima de cualquier fregadero. Los ganchos laterales permiten colgar utensilios grandes, mientras que el espacio interior nos permite colocar cualquier tipo de elemento para su escurrido.

Designed to be hung above any sink. The side hooks allow you to hang large utensils, while the internal space allows us to place any type of element for draining.



Conçu pour être suspendu au-dessus de n'importe quel évier. Les crochets latéraux permettent d'accrocher de grands ustensiles, tandis que l'espace intérieur nous permet de placer tout type d'élément pour égoutter.

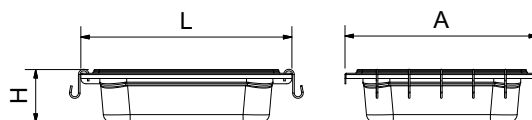

L	I	H	✓	Kg	Barcode	€
400	365	100	10	2,4	042602	<b>50,00</b>

Incluye 10 ganchos.  
10 hook Includes.  
Comprend 10 crochets.

## Fregaderos para lavavasos y lavaplatos

Sink units for dishwashers  
Éviers pour lave-vaisselles



### Características de fabricación:

Fregaderos diseñados para alojar lavavasos o lavaplatos bajo el escurridor.  
Fabricados en acero inoxidable.  
Pies regulables para una mejor adaptación a la altura de la máquina.  
Entrepañeo en su base para un mejor aprovechamiento del espacio, pues permite la colocación de cestas y objetos.



Detalle de instalación.  
Installation example.  
Exemple d'installation.

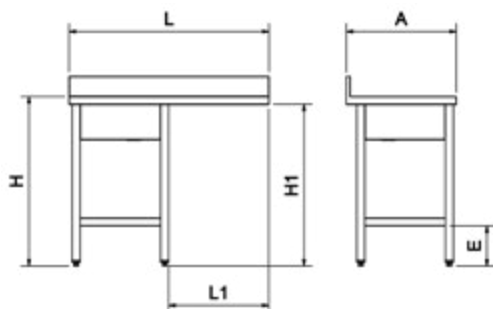





### Caractéristiques de fabrication:

Éviers dessinés pour loger lave-vaisselles dessus l'égouttoir.  
Fabriqué en acier inoxydable.  
Pieds réglables pour achever une meilleure adaptation des machines.  
Châssis avec tablette-rayon pour profiter l'espace le mieux, puisqu'il permet de loger des objets.

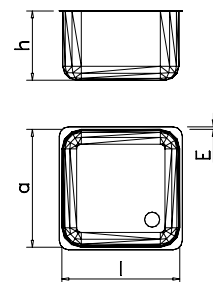
### Manufacturing characteristics:

Sink units designed to lodge dishwashers under the drain board.  
Made of stainless steel.  
Adjustable feet in order to get a better adaptation of the machinery.  
Frame with shelf for a better use of space, since it allows to lodge several objects.



								Espacio útil Room Espacement					
L	A	H	E	I	a	h	L1	H1	Kg	Barcode	€		
	1.000	550	850	200	340	340	200	500	810-890	15,0	054230	<b>601,00</b>	
	1.200	600	890	200	500	400	250	600	810-890	20,0	054214	<b>619,00</b>	
	1.200	700	890	200	400	500	250	600	810-890	24,0	054218	<b>692,00</b>	
	1.000	550	850	200	340	340	200	500	810-890	15,0	054232	<b>601,00</b>	
	1.200	600	890	200	500	400	250	600	810-890	20,0	054216	<b>619,00</b>	
	1.200	700	890	200	400	500	250	600	810-890	24,0	054220	<b>692,00</b>	
	1.400	550	850	200	400	400	250	500	810-890	22,0	054234	<b>869,00</b>	
	1.600	600	890	200	400	400	250	600	810-890	34,0	054222	<b>930,00</b>	
	1.600	700	890	200	400	500	250	600	810-890	36,0	054226	<b>960,00</b>	
	1.400	550	850	200	400	400	250	500	810-890	22,0	054236	<b>869,00</b>	
	1.600	600	890	200	400	400	250	600	810-890	34,0	054224	<b>930,00</b>	
	1.600	700	890	200	400	500	250	600	810-890	36,0	054228	<b>960,00</b>	

## Fregaderos con soporte

Floor-mounted sink units  
Éviers avec support



						Sin entrepaño Without shelf Sans étagère			Con entrepaño With shelf Avec étagère			
L	A	H	l	a	h	Kg	Barcode	€	Kg	Barcode	€	
	450	450	850	370	340	170	10,1	050602	<b>356,00</b>	11,2	050802	<b>435,00</b>
	450	500	850	370	340	170	10,5	050604	<b>356,00</b>	11,7	050804	<b>435,00</b>
	600	500	850	500	400	150	12,1	050606	<b>398,00</b>	13,5	050806	<b>488,00</b>
	600	600	850	500	500	300	17,3	054800	<b>537,00</b>	18,9	055000	<b>665,00</b>
	700	600	850	500	400	250	18,5	054802	<b>562,00</b>	20,3	055002	<b>745,00</b>
	700	700	850	500	500	300	18,6	056002	<b>647,00</b>	20,7	056202	<b>835,00</b>
	800	600	850	500	400	250	19,7	054804	<b>672,00</b>	21,7	055004	<b>848,00</b>
	800	700	850	600	500	300	21,2	056004	<b>658,00</b>	28,4	056204	<b>849,00</b>
	1.000	600	850	860	420	350	22,0	054828	<b>919,00</b>	28,0	055028	<b>1.065,00</b>
	1.000	700	850	860	495	375	24,0	056028	<b>991,00</b>	30,0	056228	<b>1.158,00</b>
	1.200	600	850	1.060	420	350	26,0	054830	<b>1.043,00</b>	34,0	055030	<b>1.189,00</b>
	1.200	700	850	1.060	500	375	28,0	056030	<b>1.011,00</b>	46,0	056230	<b>1.188,00</b>
	1.500	600	850	1.160	420	600	31	053812	<b>1.199,00</b>			
	1.500	700	850	1.160	490	600	34	053824	<b>1.261,00</b>			
	1.300	700	850	800	495	370	28,2	053602	<b>1.131,00</b>			
	1.600	700	850	960	500	375	36,7	053606	<b>1.029,00</b>			
	1.300	700	850	800	495	370	28,2	053604	<b>1.131,00</b>			
	1.600	700	850	960	500	375	36,7	053608	<b>1.029,00</b>			
	800	500	850	370	340	120	13,2	050616	<b>402,00</b>	15,0	050816	<b>529,00</b>
	1.000	500	850	420	350	150	14,9	050628	<b>413,00</b>	17,1	050828	<b>549,00</b>
	1.000	550	850	340	340	200	17,5	051802	<b>576,00</b>	23,0	052002	<b>682,00</b>
	1.000	600	850	500	400	250	20,8	054806	<b>648,00</b>	23,2	055006	<b>793,00</b>
	1.000	700	850	500	500	300	22,4	056006	<b>707,00</b>	25,0	056206	<b>868,00</b>
	1.200	600	850	500	400	250	24,5	054810	<b>621,00</b>	27,3	055010	<b>777,00</b>
	1.200	700	850	400	500	250	26,2	056010	<b>715,00</b>	29,3	056210	<b>936,00</b>
	1.300	600	850	500	500	300	26,0	054814	<b>737,00</b>	29,0	055014	<b>904,00</b>
	1.300	700	850	500	500	300	26,7	056014	<b>751,00</b>	29,9	056214	<b>924,00</b>
	1.400	600	850	500	400	250	26,9	054818	<b>721,00</b>	30,1	055018	<b>902,00</b>
	1.400	700	850	600	500	300	28,7	056018	<b>813,00</b>	32,2	056218	<b>999,00</b>
	800	500	850	370	340	120	13,2	050618	<b>402,00</b>	15,0	050818	<b>529,00</b>
	1.000	500	850	420	350	150	14,9	050630	<b>413,00</b>	17,1	050830	<b>549,00</b>
	1.000	550	850	340	340	200	17,5	051804	<b>576,00</b>	23,0	052004	<b>682,00</b>
	1.000	600	850	500	400	250	20,8	054808	<b>648,00</b>	23,2	055008	<b>793,00</b>
	1.000	700	850	500	500	300	22,4	056008	<b>707,00</b>	25,0	056208	<b>868,00</b>
	1.200	600	850	500	400	250	24,5	054812	<b>621,00</b>	27,3	055012	<b>777,00</b>
	1.200	700	850	400	500	250	26,2	056012	<b>677,00</b>	29,3	056212	<b>897,00</b>
	1.300	600	850	500	500	300	26,0	054816	<b>737,00</b>	29,0	055016	<b>904,00</b>
	1.300	700	850	500	500	300	26,7	056016	<b>791,00</b>	29,9	056216	<b>965,00</b>
	1.400	600	850	500	400	250	26,9	054820	<b>721,00</b>	30,1	055020	<b>902,00</b>
	1.400	700	850	600	500	300	28,7	056020	<b>813,00</b>	32,2	056220	<b>999,00</b>



**Fregaderos con soporte**  
Floor-mounted sink units  
Éviers avec support

Válido para lavavasos.  
Valid for glass washers.  
Valide pour machines à laver  
verres.



Válido para lavaplatos.  
Valid for dish washers.  
Valide pour machines à laver  
assiettes.

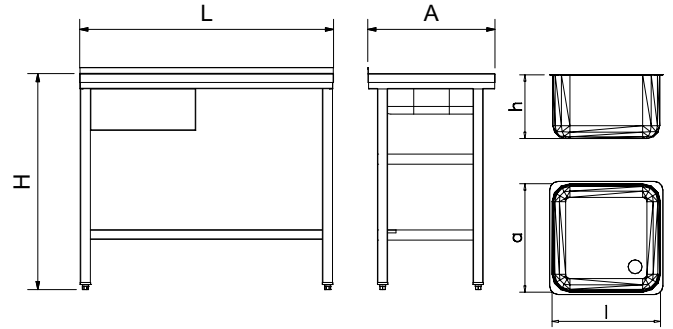

						Sin entrepaño Without shelf Sans étagère							Con entrepaño With shelf Avec étagère	
L	A	H	l	a	h	Kg	Barcode	€	Kg	Barcode	€			
800	500	850	340	370	150	13,9	050610	<b>485,00</b>	15,7	050810	<b>611,00</b>			
1.000	600	850	400	400	250	24,8	054822	<b>866,00</b>	27,2	055022	<b>1.014,00</b>			
1.000	700	850	400	500	250	26,4	056022	<b>954,00</b>	29,0	056222	<b>1.104,00</b>			
1.200	600	850	500	400	250	26,8	054824	<b>946,00</b>	29,6	055024	<b>1.105,00</b>			
1.200	700	850	500	500	300	28,6	056024	<b>973,00</b>	31,6	056224	<b>1.142,00</b>			
1.400	600	850	500	400	250	31,9	054826	<b>919,00</b>	35,1	055026	<b>1.098,00</b>			
1.400	700	850	600	500	300	33,7	056026	<b>1.011,00</b>	37,2	056226	<b>1.201,00</b>			
2.000	600	850	800	420	600	42	054018	<b>1.853,00</b>						
2.000	700	850	800	495	600	48	054036	<b>1.961,00</b>						
1.200	500	850	340	370	150	17,0	050636	<b>540,00</b>	19,5	050836	<b>648,00</b>			
1.400	550	850	400	400	250	21,0	051806	<b>757,00</b>	25,0	052006	<b>850,00</b>			
1.400	600	850	400	400	250	29,4	054832	<b>1.030,00</b>	32,6	055032	<b>1.206,00</b>			
1.400	700	850	400	500	250	31,2	056032	<b>855,00</b>	34,7	056232	<b>1.041,00</b>			
1.600	600	850	400	400	250	33,4	054846	<b>1.114,00</b>	40,5	055046	<b>1.213,00</b>			
1.600	700	850	400	500	250	35,2	056046	<b>1.115,00</b>	42,5	056246	<b>1.227,00</b>			
2.000	600	850	500	400	250	39,7	054840	<b>857,00</b>	44,6	055040	<b>1.071,00</b>			
2.000	700	850	600	500	300	41,8	056040	<b>1.309,00</b>	46,5	056240	<b>1.526,00</b>			
1.200	500	850	340	370	150	17,0	050638	<b>540,00</b>	19,5	050838	<b>648,00</b>			
1.400	550	850	400	400	250	21,0	051808	<b>757,00</b>	25,0	052008	<b>850,00</b>			
1.400	600	850	400	400	250	29,4	054834	<b>1.030,00</b>	32,6	055034	<b>1.206,00</b>			
1.400	700	850	400	500	250	31,2	056034	<b>855,00</b>	34,7	056234	<b>1.041,00</b>			
1.600	600	850	400	400	250	33,4	054848	<b>1.114,00</b>	40,5	055048	<b>1.213,00</b>			
1.600	700	850	400	500	250	35,2	056048	<b>1.115,00</b>	42,5	056248	<b>1.227,00</b>			
2.000	600	850	500	400	250	39,7	054842	<b>857,00</b>	44,6	055042	<b>1.071,00</b>			
2.000	700	850	600	500	300	41,8	056042	<b>1.309,00</b>	46,5	056242	<b>1.526,00</b>			
2.000	600	850	400	400	250	39,7	054844	<b>998,00</b>	44,0	055044	<b>1.210,00</b>			
2.000	700	850	400	500	250	41,8	056044	<b>1.113,00</b>	46,5	056244	<b>1.333,00</b>			
1.800	600	850	500	400	250	45,0	054850	<b>1.468,00</b>						
1.800	700	850	400	500	300	50,0	056050	<b>1.437,00</b>						



## Fregaderos colgantes con cartelas

Wall mounted sinks with brackets

Plonges inox suspendues avec équerres

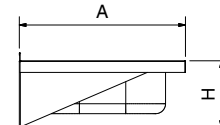
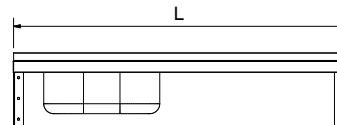
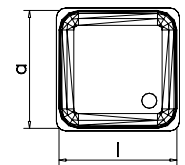
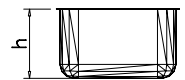
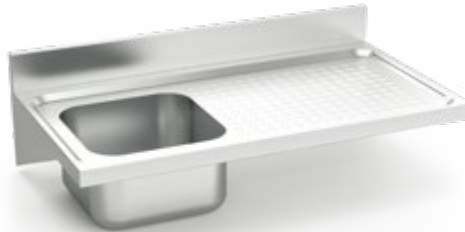

L	A	H	l	a	h	Kg	Barcode	€
450	450	205	370	340	170	4,0	057402	<b>142,00</b>
450	500	205	370	340	170	3,8	057404	<b>165,00</b>
600	500	205	500	400	150	4,8	057406	<b>157,00</b>
600	600	205	500	500	300	9,5	057600	<b>279,00</b>
700	600	205	500	400	250	10,3	057602	<b>340,00</b>
800	600	205	500	400	250	11,0	057604	<b>365,00</b>
1.000	600	205	860	420	350	16,5	057628	<b>573,00</b>
1.200	600	205	1.060	420	350	18,5	057630	<b>685,00</b>
800	500	205	370	340	120	5,1	057416	<b>183,00</b>
1.000	500	205	420	350	150	5,8	057428	<b>200,00</b>
1.000	550	205	340	340	200	10,5	057802	<b>367,00</b>
1.000	600	205	500	400	250	11,0	057606	<b>455,00</b>
1.200	600	205	500	400	250	13,6	057610	<b>374,00</b>
1.300	600	205	500	500	300	14,6	057614	<b>442,00</b>
1.400	600	205	500	400	250	15,0	057618	<b>413,00</b>
800	500	205	370	340	120	5,1	057418	<b>183,00</b>
1.000	500	205	420	350	150	5,8	057430	<b>200,00</b>
1.000	550	205	340	340	200	10,5	057804	<b>367,00</b>
1.000	600	205	500	400	250	11,0	057608	<b>455,00</b>
1.200	600	205	500	400	250	13,6	057612	<b>374,00</b>
1.300	600	205	500	500	300	14,6	057616	<b>442,00</b>
1.400	600	205	500	400	250	15,0	057620	<b>413,00</b>

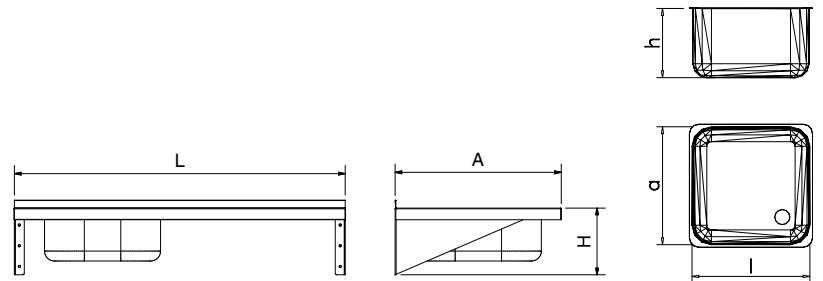

L	A	H	l	a	h	Kg	Barcode	€
800	500	205	340	370	150	5,8	057410	<b>237,00</b>
1.000	600	205	400	400	250	15,0	057622	<b>567,00</b>
1.200	600	205	500	400	250	16,0	057624	<b>588,00</b>
1.400	600	205	500	400	250	20,0	057626	<b>541,00</b>
1.200	500	205	340	370	150	6,8	057436	<b>276,00</b>
1.400	550	205	400	400	250	16,5	057806	<b>420,00</b>
1.400	600	205	400	400	250	17,5	057632	<b>690,00</b>
1.200	500	205	340	370	150	6,8	057438	<b>276,00</b>
1.400	550	205	400	400	250	16,5	057808	<b>420,00</b>
1.400	600	205	400	400	250	17,5	057634	<b>690,00</b>



## Fregaderos colgantes con faldón o palomillas

Wall-mounted sink units with skirt or brackets

Éviers suspendus avec habillage ou barres de fixation



							Con faldón With skirt Avec habillage			Con palomillas With brackets Avec barres de fixation		
L	A	H	H1	l	a	h	Kg	Barcode	€	Kg	Barcode	€
450	450	200	450	370	340	170	4,1	050202	<b>187,00</b>	7,0	050402	<b>384,00</b>
450	500	200	450	370	340	170	5,4	050204	<b>349,00</b>	7,6	050404	<b>384,00</b>
600	500	200	450	500	400	150	6,6	050206	<b>374,00</b>	9,0	050406	<b>414,00</b>
600	600	250	450	500	500	300	13,5	054400	<b>561,00</b>	14,8	054600	<b>637,00</b>
700	600	300	450	500	400	250	14,8	054402	<b>611,00</b>	16,0	054602	<b>686,00</b>
700	700	300	450	500	500	300	15,9	055602	<b>673,00</b>	16,6	055802	<b>823,00</b>
800	600	355	450	500	400	250	16,1	054404	<b>658,00</b>	17,2	054604	<b>736,00</b>
800	700	320	450	600	500	300	17,7	055604	<b>701,00</b>	19,1	055804	<b>789,00</b>
1.000	600	355	450	860	420	350	14,5	054428	<b>1.001,00</b>	25,1	054628	<b>1.121,00</b>
1.000	700	340	450	860	495	375	15,5	055628	<b>1.061,00</b>	27,3	055828	<b>1.189,00</b>
1.200	600	355	450	1.060	420	350	16,5	054430	<b>1.181,00</b>	29,4	054630	<b>1.314,00</b>
1.200	700	340	450	1.060	500	375	17,5	055630	<b>1.149,00</b>	31,8	055830	<b>1.288,00</b>
800	500	200	450	370	340	120	8,0	050216	<b>393,00</b>	9,9	050416	<b>434,00</b>
1.000	500	200	450	420	350	150	9,3	050228	<b>398,00</b>	11,3	050428	<b>440,00</b>
1.000	600	355	450	500	400	250	16,5	054406	<b>776,00</b>	18,0	054606	<b>861,00</b>
1.000	700	300	450	500	500	300	18,2	055606	<b>818,00</b>	20,1	055806	<b>906,00</b>
1.200	600	355	450	500	400	250	19,9	054410	<b>739,00</b>	21,5	054610	<b>826,00</b>
1.200	700	300	450	400	500	250	21,6	055610	<b>823,00</b>	23,8	055810	<b>916,00</b>
1.300	600	300	450	500	500	300	21,2	054414	<b>832,00</b>	23,0	054614	<b>921,00</b>
1.300	700	300	450	500	500	300	21,8	055614	<b>854,00</b>	24,2	055814	<b>1.000,00</b>
1.400	600	320	450	500	400	250	22,3	054418	<b>824,00</b>	23,8	054618	<b>920,00</b>
1.400	700	320	450	600	500	300	24,0	055618	<b>917,00</b>	26,2	055818	<b>1.023,00</b>
800	500	200	450	370	340	120	8,0	050218	<b>393,00</b>	9,9	050418	<b>434,00</b>
1.000	500	200	450	420	350	150	9,3	050230	<b>398,00</b>	11,3	050430	<b>440,00</b>
1.000	600	355	450	500	400	250	16,5	054408	<b>776,00</b>	18,0	054608	<b>861,00</b>
1.000	700	300	450	500	500	300	18,2	055608	<b>818,00</b>	20,1	055808	<b>906,00</b>
1.200	600	355	450	500	400	250	19,9	054412	<b>739,00</b>	21,5	054612	<b>877,00</b>
1.200	700	300	450	400	500	250	21,6	055612	<b>784,00</b>	23,8	055812	<b>878,00</b>
1.300	600	300	450	500	500	300	21,2	054416	<b>832,00</b>	23,0	054616	<b>921,00</b>
1.300	700	300	450	500	500	300	21,8	055616	<b>893,00</b>	24,2	055816	<b>1.000,00</b>
1.400	600	320	450	500	400	250	22,3	054420	<b>824,00</b>	23,8	054620	<b>920,00</b>
1.400	700	320	450	600	500	300	24,0	055620	<b>917,00</b>	26,2	055820	<b>1.023,00</b>

## Fregaderos colgantes con faldón o palomilla de doble seno

Wall-mounted double bowl sink with skirt or brackets

Plonges suspendus avec habillage ou équerres avec double cuve

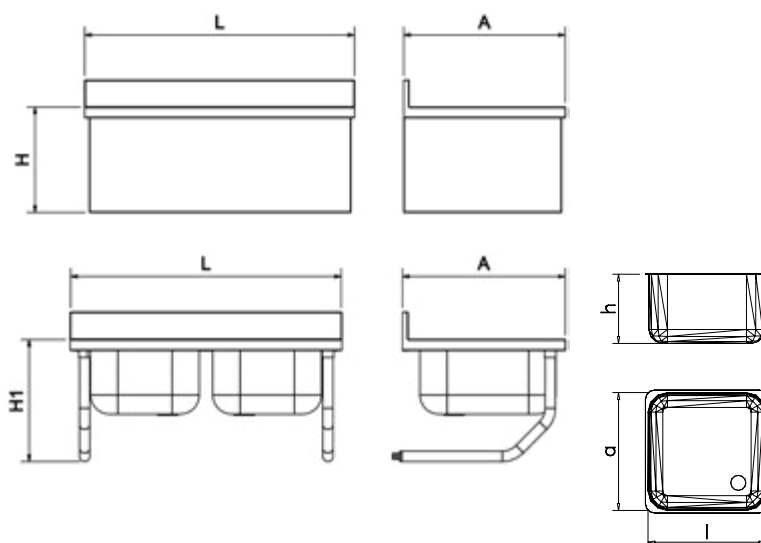

										Con faldón With skirt Avec habillage			Con palomillas With brackets Avec barres de fixation		
L	A	H	H1	l	a	h	Kg	Barcode	€	Kg	Barcode	€			
800	500	200	450	340	370	150	8,7	050210	<b>461,00</b>	10,6	050410	<b>511,00</b>			
1.000	600	355	450	400	400	250	19,8	054422	<b>937,00</b>	21,8	054622	<b>1.046,00</b>			
1.000	700	250	450	400	500	250	21,4	055622	<b>1.031,00</b>	23,9	055822	<b>1.140,00</b>			
1.200	600	355	450	500	400	250	22,2	054424	<b>992,00</b>	23,9	054624	<b>1.105,00</b>			
1.200	700	300	450	500	500	300	23,9	055624	<b>1.027,00</b>	26,1	055824	<b>1.148,00</b>			
1.400	600	320	450	500	400	250	27,3	054426	<b>964,00</b>	28,8	054626	<b>1.084,00</b>			
1.400	700	320	450	600	500	300	29,0	055626	<b>1.063,00</b>	31,2	055826	<b>1.268,00</b>			
1.200	500	200	450	340	370	150	10,9	050236	<b>497,00</b>	13,1	050436	<b>550,00</b>			
1.400	600	250	450	400	400	250	23,6	054432	<b>1.089,00</b>	26,1	054632	<b>1.200,00</b>			
1.400	700	250	450	400	500	250	25,2	055632	<b>1.080,00</b>	28,1	055832	<b>1.195,00</b>			
1.600	600	320	450	400	400	250	29,0	054446	<b>1.175,00</b>	32,0	054646	<b>1.344,00</b>			
1.600	700	320	450	400	500	250	30,0	055646	<b>1.219,00</b>	34,0	055846	<b>1.360,00</b>			
2.000	600	320	450	500	400	250	34,0	054440	<b>1.120,00</b>	36,0	054640	<b>1.270,00</b>			
2.000	700	320	450	600	500	300	35,8	055640	<b>1.415,00</b>	38,8	055840	<b>1.564,00</b>			
1.200	500	200	450	340	370	150	10,9	050238	<b>497,00</b>	13,1	050438	<b>550,00</b>			
1.400	600	250	450	400	400	250	23,6	054434	<b>1.089,00</b>	26,1	054634	<b>1.200,00</b>			
1.400	700	250	450	400	500	250	25,2	055634	<b>936,00</b>	28,1	055834	<b>1.195,00</b>			
1.600	600	320	450	400	400	250	29,0	054448	<b>1.175,00</b>	32,0	054648	<b>1.344,00</b>			
1.600	700	320	450	400	500	250	30,0	055648	<b>1.219,00</b>	34,0	055848	<b>1.360,00</b>			
2.000	600	320	450	500	400	250	34,0	054442	<b>1.120,00</b>	36,0	054642	<b>1.270,00</b>			
2.000	700	320	450	600	500	300	35,8	055642	<b>1.415,00</b>	38,8	055842	<b>1.564,00</b>			
2.000	600	250	450	400	400	250	32,5	054444	<b>1.100,00</b>	35,7	054644	<b>1.249,00</b>			
2.000	700	250	450	400	500	250	34,3	055644	<b>1.380,00</b>	38,6	055844	<b>1.526,00</b>			



## Fregaderos con puertas de corredera y abatibles

Sink units with sliding and hinged doors

Éviers à portes coulissantes et à portes à deux battants



### Características:

Laterales forrados en acero inoxidable. Entrepaña a 200 mm del suelo. Puertas colgadas, lo que evita depósitos de suciedad en carriles y entrepaño. Escurridor inclinado.

### Characteristics:

Sides lined in stainless steel. Hanging doors. They avoid dirtiness deposits in rails and shelves. Undershelf at 200 mm. from the floor.

### Caractéristiques:

Latérales recouvertes en acier inoxydable. Portes sont suspendues pour éviter des dépôts de saleté dans les rails et dans les tablettes-rayons. Tablette à 200 mm. du sol.



						Puertas correderas Sliding doors Portes coulissantes			Puertas abatibles Hinged doors Portes battantes		
L	A	H	l	a	h	Kg	Barcode	€	Kg	Barcode	€
									21,5	051206	<b>1.085,00</b>
									27,6	055400	<b>1.139,00</b>
						28,8	055204	<b>1.252,00</b>	22,6	055404	<b>1.410,00</b>
						32,0	056404	<b>1.553,00</b>	35,8	056604	<b>1.750,00</b>
						36,0	055228	<b>1.449,00</b>	40,0	055428	<b>1.639,00</b>
						40,0	056428	<b>1.702,00</b>	44,0	056628	<b>1.913,00</b>
						43,0	055230	<b>1.824,00</b>	50,0	055430	<b>2.051,00</b>
						46,0	056430	<b>1.960,00</b>	54,0	056630	<b>2.213,00</b>
						21,8	051016	<b>983,00</b>	25,6	051216	<b>1.098,00</b>
						25,7	051028	<b>1.030,00</b>	29,5	051228	<b>1.148,00</b>
						32,2	055206	<b>1.318,00</b>	36,0	055406	<b>1.469,00</b>
						35,8	056406	<b>1.549,00</b>	39,6	056606	<b>1.735,00</b>
						37,2	055210	<b>1.325,00</b>	41,0	055410	<b>1.490,00</b>
						41,0	056410	<b>1.543,00</b>	44,8	056610	<b>1.733,00</b>
						40,8	055214	<b>1.505,00</b>	46,5	055414	<b>1.688,00</b>
						43,7	056414	<b>1.676,00</b>	49,4	056614	<b>1.886,00</b>
						42,3	055218	<b>1.562,00</b>	48,0	055418	<b>1.759,00</b>
						46,5	056418	<b>1.824,00</b>	52,2	056618	<b>2.039,00</b>
						21,8	051018	<b>983,00</b>	25,6	051218	<b>1.098,00</b>
						25,7	051030	<b>1.030,00</b>	29,5	051230	<b>1.148,00</b>
						32,2	055208	<b>1.318,00</b>	36,0	055408	<b>1.469,00</b>
						35,8	056408	<b>1.549,00</b>	39,6	056608	<b>1.735,00</b>
						37,2	055212	<b>1.325,00</b>	41,0	055412	<b>1.490,00</b>
						41,0	056412	<b>1.504,00</b>	44,8	056612	<b>1.694,00</b>
						40,8	055216	<b>1.505,00</b>	46,5	055416	<b>1.688,00</b>
						43,7	056416	<b>1.715,00</b>	49,4	056616	<b>1.924,00</b>
						42,3	055220	<b>1.562,00</b>	48,0	055420	<b>1.759,00</b>
						46,5	056420	<b>1.824,00</b>	52,2	056620	<b>2.039,00</b>

## Fregaderos con puertas de corredera y abatibles

Sink units with sliding and hinged doors

Éviers à portes coulissantes et à portes à deux battants

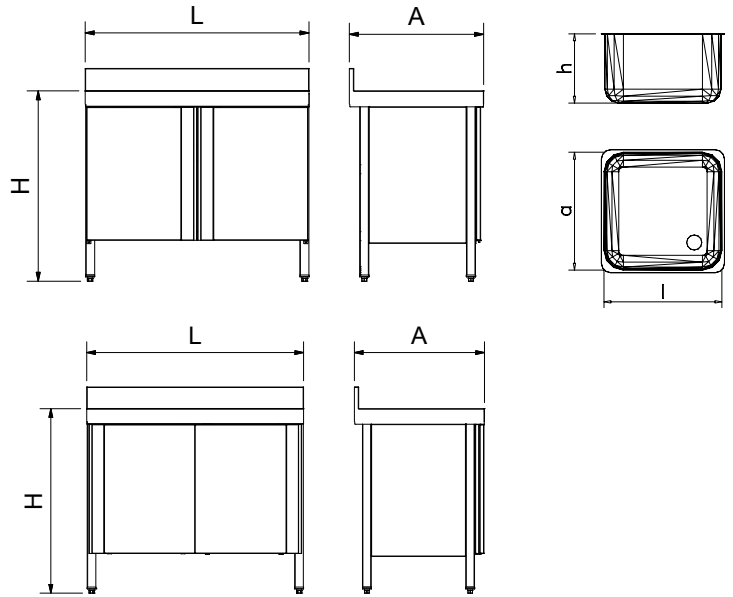

							Puertas correderas Sliding doors Portes coulissantes			Puertas abatibles Hinged doors Portes battantes		
L	A	H	l	a	h	Kg	Barcode	€	Kg	Barcode	€	
800	500	850	340	370	150	25,5	051010	<b>1.022,00</b>	26,3	051210	<b>986,00</b>	
1.000	600	850	400	400	250	36,0	055222	<b>1.433,00</b>	39,8	055422	<b>1.614,00</b>	
1.000	700	850	400	500	250	39,6	056422	<b>1.702,00</b>	43,4	056622	<b>1.902,00</b>	
1.200	600	850	500	400	250	39,4	055224	<b>1.536,00</b>	43,2	055424	<b>1.727,00</b>	
1.200	700	850	500	500	300	43,3	056424	<b>1.707,00</b>	47,1	056624	<b>1.921,00</b>	
1.400	600	850	500	400	250	47,1	055226	<b>1.647,00</b>	52,8	055426	<b>1.862,00</b>	
1.400	700	850	600	500	300	51,2	056426	<b>1.911,00</b>	56,9	056626	<b>2.151,00</b>	
1.200	500	850	340	370	150	22,3	051036	<b>1.130,00</b>	26,1	051236	<b>1.148,00</b>	
1.400	600	850	400	400	250	44,7	055232	<b>1.772,00</b>	50,4	055432	<b>1.974,00</b>	
1.400	700	850	400	500	250	48,9	056432	<b>1.804,00</b>	54,6	056632	<b>2.149,00</b>	
1.600	600	850	400	400	250	52,0	055246	<b>2.086,00</b>	57,0	055446	<b>2.349,00</b>	
1.600	700	850	400	500	250	56,0	056446	<b>2.339,00</b>	61,5	056646	<b>2.631,00</b>	
2.000	600	850	500	400	250	60,7	055240	<b>2.189,00</b>	68,3	055440	<b>2.694,00</b>	
2.000	700	850	600	500	300	65,8	056440	<b>2.664,00</b>	73,4	056640	<b>2.992,00</b>	
1.200	500	850	340	370	150	22,3	051038	<b>1.130,00</b>	26,1	051238	<b>1.148,00</b>	
1.400	600	850	400	400	250	44,7	055234	<b>1.772,00</b>	50,4	055434	<b>1.974,00</b>	
1.400	700	850	400	500	250	48,9	056434	<b>1.804,00</b>	54,6	056634	<b>2.149,00</b>	
1.600	600	850	400	400	250	52,0	055248	<b>2.086,00</b>	57,0	055448	<b>2.349,00</b>	
1.600	700	850	400	500	250	56,0	056448	<b>2.339,00</b>	61,5	056648	<b>2.631,00</b>	
2.000	600	850	500	400	250	60,7	055242	<b>2.189,00</b>	68,3	055442	<b>2.694,00</b>	
2.000	700	850	600	500	300	65,8	056442	<b>2.664,00</b>	73,4	056642	<b>2.992,00</b>	
2.000	600	850	400	400	250	60,7	055244	<b>2.281,00</b>	68,3	055444	<b>2.773,00</b>	
2.000	700	850	400	500	250	65,8	056444	<b>2.554,00</b>	73,4	056644	<b>2.877,00</b>	



## Fregaderos portátiles

Mobile sinks  
Plonges portables



054210

054240

054244



054212

054242

054246

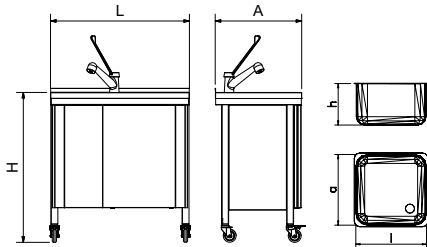

**Funcionamiento**  
Operation  
Opération

**Autónomo-Hidráulico**  
Autonomous-Hydraulic  
Autonome-Hydraulique

**\*Batería**  
\*Battery  
\*Batterie

**Conexión a red eléctrica**  
Mains connection  
Raccordement au réseau

**Tipo de accionamiento**  
Operation  
Accionnement



**Agua fría**  
Cold water  
Eau froide



**Agua caliente**  
Hot water  
Eau chaude

Opcional  
Optional  
Optionnel

Opcional  
Optional  
Optionnel



**Potencia**  
Power  
Puissance

-----

-----

2.000 W

**Tensión**  
Voltage  
Tension

-----

12 V

220-240 V

**Frecuencia**  
Frequency  
Fréquence

-----

-----

50-60 Hz.

L

800 mm

800 mm

800 mm

A

500 mm

500 mm

500 mm

H

850 mm

850 mm

850 mm

**Peso / Weight / Poids**

25,00 Kg.

26,00 Kg.

31,00 Kg.

**Dimensiones cubeta**  
Bowl dimensions  
Dimensions évier

370x340 mm

370x340 mm

370x340 mm

**Profundidad cubeta**  
Bowl depth  
Profondeur évier

120 mm

120 mm

120 mm

**Capacidad agua limpia**  
Clean water tank capacity  
Capacité eau propre

25 l.

25 l.

25 l.

**Capacidad agua sucia**  
Dirty water tank capacity  
Capacité eau sale

25 l.

25 l.

25 l.

**1.140,00€**

**1.485,00€**

**1.525,00€**

\*Incluye cargador de batería. 220-240 V 50-60 Hz.  
\*Includes battery charger. 220-240 V 50-60 Hz.  
\*Chargeur de batterie inclus. 220-240 V 50-60 Hz.



## Elevador inox de fondo de fregaderos

Stainless steel bottom lifter for sinks

Élévateur en acier inoxydable pour plonge

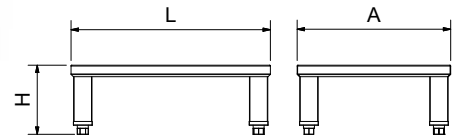

L	A	H	Para cubetas de For sinks of Pour les plonges de	Kg	Barcode	€
435	335	150	500x400	1,5	051620	<b>47,00</b>
435	435	150	500x500	1,8	051622	<b>52,00</b>

## Fregadero vertedero

Sink-drain

Eviers-déversoir



### Características:

Totalmente construido en acero inoxidable.  
Bastidor soldado, construido en tubo de 40x40 mm que garantiza una máxima solidez y resistencia al peso de grandes ollas y cubos.  
Encimera con reborde salva-aguas.

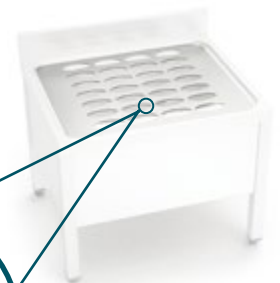

Tapa soporte para cubos y ollas.  
Sheet-support for pots and buckets.  
Plaque-support pour pots  
seaux.

Barcode 054209 € **75,00**

L 620 mm. A 520 mm.

Op Opcional / Optional / Optionnel

### Characteristics:

Wholly made of stainless steel.  
Welded frame, made in tube 40x40, which guarantees the highest stability and solidity for the weight of big pots and buckets.  
Top with water-safe edge.

### Caractéristiques:

Totalement en acier inoxydable.  
Structure soudée, fabriqué en tube 40x40, lequel garantit la meilleure stabilité et solidité pour le poids des grands pots et seaux.  
Partie supérieure avec rebord contre écoulement d'eau.

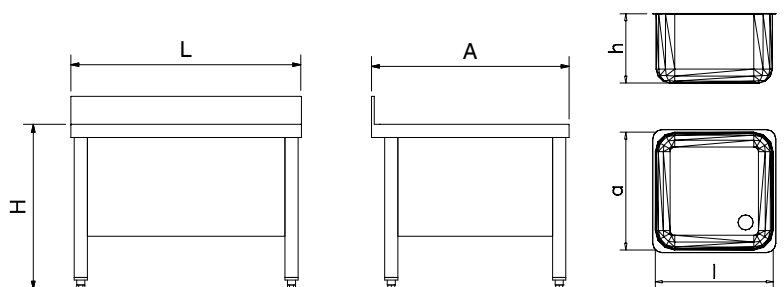

L	A	H	l	a	h	Kg	Barcode	€
700	600	550	500	400	250	16	054208	<b>625,00</b>

## Fregadero especial para escayolas

Sink unit with integral sump. Specially for plaster preparation  
Evier avec bouche intégré. Spécial pour le préparation des pâtres

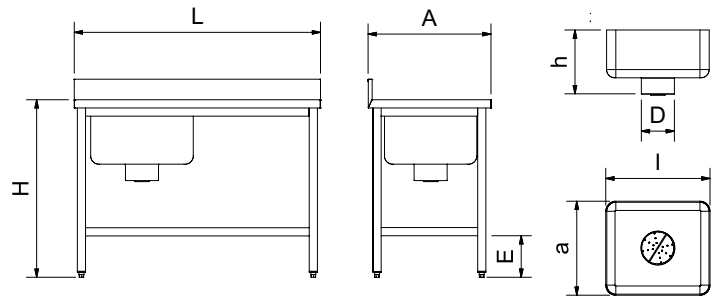
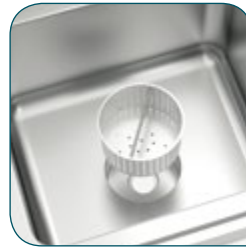

	L	A	H	I	a	D	h	E	Kg	Barcode	€
	1.200	600	850	500	500	160	200	200	24	076202	<b>1.100,00</b>
	1.200	600	850	500	500	160	200	200	24	076204	<b>1.100,00</b>

## Fregadero para bicicletas XL

XL bike sink  
Plonge à vélo XL

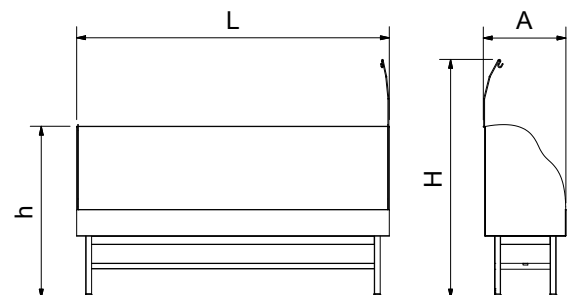

**N**ovedad  
NEW  
Nouveauté

L	A	H	h	Kg	Barcode	€
2.120	560	1.620	1.165	55,0	054252	<b>1.155,00</b>

## Calentador de agua instantáneo

Instant water heater  
Chauffe-eau instantané



Temperatura de salida del agua de 35°C a 50°C  
Leaving water temperature 35°C - 50°C  
Température de sortie d'eau 35°C - 50°C

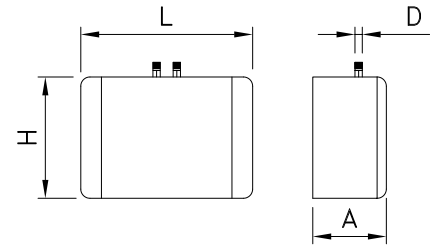

L	A	H	D	°C	l/min	Potencia Power Puissance	Tensión Voltage Tension	Frecuencia Frequency Fréquence	Kg	Barcode	€
165	70	200	3/8"	50°C	2,0	3.500 W	230 V	50 Hz.	1,1	461456	<b>265,00</b>

## Enfriador de agua

Water cooler  
Refrigeriseur d'eau

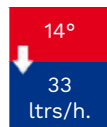

### Características:

Ideal para instalar agua fría en fregaderos, lavamanos, fuentes, etc.

Tecnología para mejorar la higiene.

Termostato para regular la temperatura del agua.

Ahorro de energía gracias a su compresor de 1/4 Hp.

CE

Fabricado en la unión Europea.

Envolverte de acero pintado.

Entrada y salida de agua de 1/2"

### Caractéristiques:

Ideal pour installer de l'eau froide sur des éviers, lavemains, fontaines, etc.

Technologie pour améliorer l'hygiène.

Thermostat pour régler la température de l'eau.

Economie d'énergie grâce à son compresseur de 1/4 Hp.

CE

Fabriqué en Union Européenne

Entrée et sortie d'eau grâce à une connexion 1/2".

Acier peint.

### Characteristics:

Ideal for incorporating cool water in sink units, hand washbasins, drinking fountains, etc.

Technology for a better hygiene

Temperature adjustment by thermostat

Energy saving through compressor - 1/4 Hp

CE

Made in UE

Inlet and outlet connectors 1/2".

Painted steel.

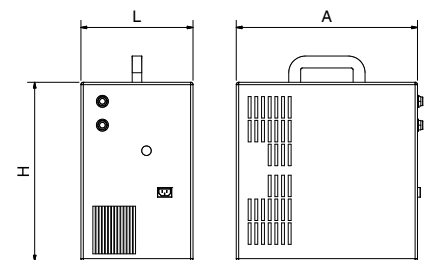

L	A	H	Potencia Power Puissance	Tensión Voltage Tension	Frecuencia Frequency Fréquence	Kg	Barcode	€
300	400	470	230 W	220-240 V	50 Hz.	18,0	461460	<b>810,00</b>

## Enjuagador de vasos y jarras a presión para fregadero

Pressure sink washer for glasses and jugs

Nettoyeur haute pression pour verres et pichets pour évier



**N**ovedad  
ew  
nouveau

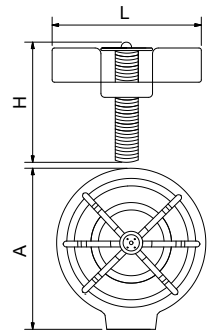

L	A	H	Gr	Barcode	€
150	130	173	200	454280	<b>25,00</b>

## Cepillo lavavasos

Glass washer brush

Brosse pour lave-verres

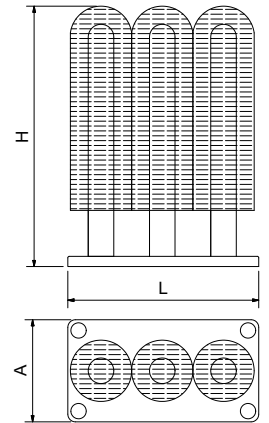

L	A	H	Gr	Barcode	€
190	100	190	390	483062	<b>24,00</b>

## Rollo de 2m de bayeta posavasos antideslizante multiusos

Multipurpose non-slip coaster cloth, 2m roll

Rouleau de 2 m de tissu anti-dérapant multi-usages



**N**ovedad  
ew  
nouveau

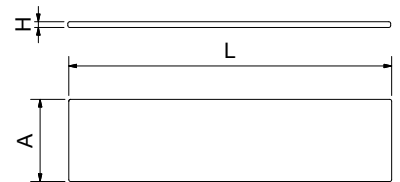

L	A	H	Kg	Barcode	€
2.000	650	1,00	1,00	482050	<b>27,00</b>

## Repuestos fregaderos

Spare parts for sink units

Pièces de rechange pour éviers



















Rebosadero (fregaderos serie 600 y 700 mm)  
Overflow (sink units models 600 & 700 mm width)  
Déversoir (éviers 600 et 700 mm de profondeur)

Descripción Description Description	Modelo Model Model	Gr	Barcode	€
250 mm	420	454220	<b>55,00</b>	
290 mm	450	454222	<b>57,50</b>	
340 mm	525	454224	<b>52,00</b>	
490 mm	600	454225	<b>61,00</b>	

## Repuestos fregaderos

Spare parts for sink units  
Pièces de rechange pour éviers

	Descripción Description Description	Modelo Model Model			€
	Válvula sin rebosadero Ø 49 mm (fregaderos serie 500, 600 y 700 mm) Drain valve without overflow Ø 49 mm (sink units models 500, 600 & 700 mm) Valvule de drainage sans déversoir Ø 49 mm (éviers model 500, 600 et 700 mm)	1 1/2"	88	454226	<b>10,00</b>
	Valvula desagüe con cestillo  Drain valve with basket for waste Vanne de vidange avec panier		50	454212	<b>6,50</b>
	Reductor desagüe de 2" a 1 1/2" Drain reducer from 2" to 1 1/2" Réducteur pour drainage de 2" à 1 1/2"		150	454218	<b>18,90</b>
	Tapón fregaderos, para válvulas de Ø 49 mm serie 600 y 700 Sink unit plug for valve Ø 49 mm series 600 & 700 Bonde pour valvule Ø 49 mm évier série 600 et 700		20	454604	<b>3,15</b>
	Válvula con rebosadero (fregaderos serie 500 mm, lavamanos, cubetas semiesféricas y fregaderos de gran capacidad) Drain valve with overflow (sink units model 500 mm, washbasins, semispheric bowls, and large capacity single sink units) Valvule de drainage avec déversoir (éviers model 500 mm, lave-mains, semisphériques cuveaux et éviers a grande capacité)	1 1/2"	145	454202	<b>6,00</b>
	Válvula de PVC con rebosadero, acabado cromado Drain valve in PVC with overflow, chrome finished Valvule de drainage avec déversoir en PVC, finition chromé	1 1/2"	150	454205	<b>43,00</b>
	Válvula sin rebosadero (fregaderos serie 500 mm) Drain valve without overflow (sink units model 500 mm) Valvule de drainage sans déversoir (éviers model 500 mm)	1 1/2"	88	454208	<b>10,50</b>
	Válvula de descarga rápida Quick drain valve Valvule pour rapide drainage	2"	3.600	454204	<b>115,00</b>
	Tapón inox cubre-agujeros (diámetro 42 mm) Hole-cover plug in stainless steel (diameter 42 mm) Bonde couvre-trou en acier inox (diamètre 42 mm)		16	454602	<b>3,00</b>
	Sifón de desagüe (fregaderos ancho 500 mm, lavamanos, gran capacidad) U-bended drainpipe (sink units 500 mm depth, washbasins, high capacity) Siphon de drainage (éviers profondeur 500 mm, lave-mains, grand capacité)	1 1/2"	169	454402	<b>6,00</b>
	Sifón de PVC acabado cromado U-bended drainpipe in PVC, chrome finish Siphon en PVC, finition chromé	1 1/2"	170	454408	<b>36,00</b>
	Sifón de latón cromado U-bended drainpipe in chrome brass Siphon en laiton chromé	1 1/2"	1.400	454404	<b>80,00</b>
		2"	2.000	454406	<b>122,00</b>
	Hacer agujero en fregadero o lavamanos Drill hole to sink Faire trou à plonge			056802	<b>33,00</b>

## Válvula de desagüe Splus modelo simple

Sink drain - Splus individual model  
Bonde Splus modèle simple



An effective system for optimizing the space!!!

**Characteristics:**

A system specially designed for better use of space under sinks, since it allows moving the drain towards the wall.

Un véritable système d'utilisation optimale de l'espace!

**Caractéristiques:**

Système conçu pour utiliser au mieux l'espace sous l'évier car on peut déplacer la bonde vers le mur.

Un verdadero sistema de optimización del espacio!!!

**Características:**

Sistema diseñado para aprovechar mejor el espacio bajo los fregaderos ya que permite desplazar el desagüe hacia la pared.



Modelo Model Model	Gr	48	454209	€
1 1/2				<b>18,90</b>

## Válvula de desagüe Splus modelo doble

Sink drain - Splus double model  
Bonde Splus modèle double

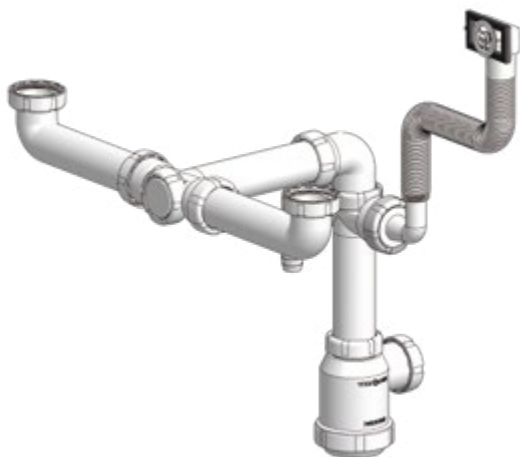

An effective system for optimizing the space!!!

**Characteristics:**

A system specially designed for better use of space under sinks, since it allows moving the drain towards the wall.

Un véritable système d'utilisation optimale de l'espace!

**Caractéristiques:**

Système conçu pour utiliser au mieux l'espace sous l'évier car on peut déplacer la bonde vers le mur.

Un verdadero sistema de optimización del espacio!!!

**Características:**

Sistema diseñado para aprovechar mejor el espacio bajo los fregaderos ya que permite desplazar el desagüe hacia la pared.

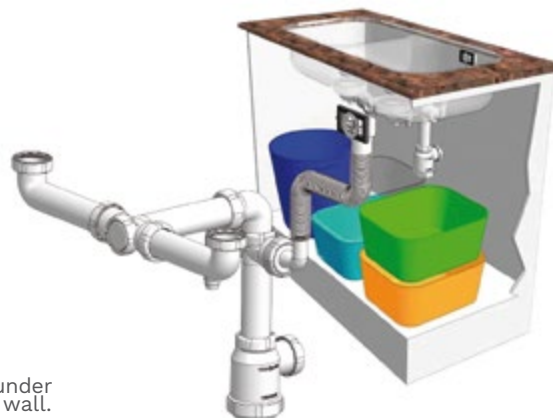

Modelo Model Model	Gr	64	454210	€
1 1/2				<b>26,00</b>

**Trampa inox para grasas de 20 lts.**  
 Stainless steel grease trap 20 lts.  
 Piège de graisse acier inoxydable 20 lts.



**Características:**

Diseñado para restaurantes, hoteles, fastfood, etc..  
 Fácil instalación y mantenimiento.  
 Rendimiento de 0 a 50 comidas.  
 Incluye:  
 Latiguillo flexible de evacuación.  
 Cestillo.  
 Desagües flexibles para la entrada y salida de agua.



**Characteristics:**

Applicable for restaurant, hotels, fast food, etc.  
 Easy installation and maintenance.  
 Capacity from 0 to 50 meals.  
 Includes:  
 Evacuation flexible hose.  
 Basket.  
 Flexible drains for water inlet and outlet.

**Caractéristiques:**

Approprié aux restaurants, hôtels, fast-food, etc.  
 Installation et entretien faciles.  
 Capacité de 0 à 50 repas.  
 Comprend:  
 Evacuation flexible.  
 Réservoir.  
 Flexible drains pour entrée et sortie d'eau.

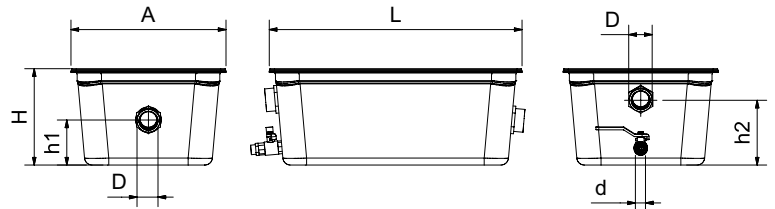

L	A	H	D	d	h1	h2	lit	Kg	Barcode	€
530	325	200	1" 1/2	1/2"	97	136	20	4,80	057202	<b>274,00</b>

**Trampa inox para grasas de 35 lts.**  
 Stainless steel grease trap 35 lts.  
 Piège de graisse acier inoxydable 35 lts.



**Características:**

Fabricado totalmente en acero inoxidable.  
 Rendimiento de 0 a 65 comidas.  
 Caudal: 1l/sg.  
 Incluye: Tapa estanca de acero inoxidable y cestillo registrable.  
 Capacidad: 35 litros.

**Characteristics:**

Wholly made of stainless steel.  
 Capacity from 0 to 65 meals.  
 Volume: 1l/sc.  
 Included: Stainless steel airtight lid and basket.  
 Capacity: 35 liters.

**Caractéristiques:**

Fabriqué entièrement en acier inoxydable.  
 Capacité de 0 à 65 repas.  
 Débit : 1l/sc.  
 Inclus : Couvercle étanche and panier.  
 Capacité: 35 litres.

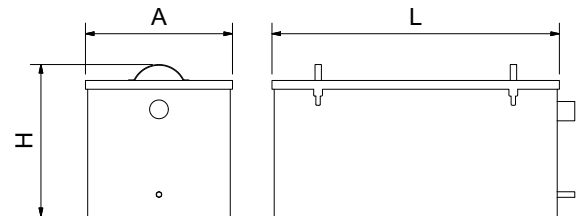

L	A	H	lit	lit	Kg	Barcode	€
560	320	300	60	35	9,50	455004	<b>299,00</b>

**Sumidero sifónico con cestillo salida vertical en acero inoxidable**  
 Stainless steel floor drain with siphon trap and vertical outlet  
 Bouche dégout siphonique sortie verticale en acier inoxydable

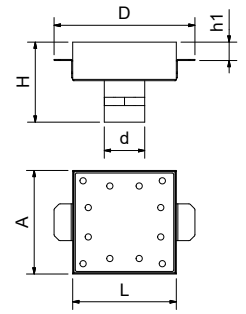

	L	A	H	h1	D	d	Kg	Barcode	€
	100	100	112	-	100	48	1,20	054274	<b>129,00</b>
	150	150	155	40	222	75	2,96	054270	<b>129,00</b>
	200	200	155	36	272	78	3,00	054276	<b>150,00</b>
	250	250	155	36	322	78	4,00	054278	<b>189,00</b>
	300	300	155	36	340	78	5,40	054280	<b>243,00</b>



## Sumidero sifónico con cestillo salida horizontal en acero inoxidable

Stainless steel floor drain with siphon trap and horizontal outlet  
Bouche dégout siphonique sortie horizontale en acier inoxydable

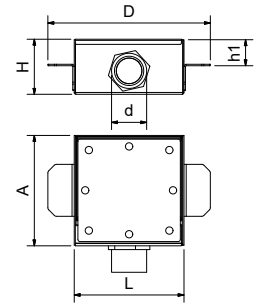

**N**ovedad  
en  
Buvcat



L	A	H	h1	D	d	Kg	Barcode	€
100	100	75	-	100	48	1,10	054282	<b>85,00</b>

**N**ovedad  
en  
Buvcat



150	150	75	36	222	48	2,00	054284	<b>145,00</b>
-----	-----	----	----	-----	----	------	--------	---------------

**N**ovedad  
en  
Buvcat



200	200	75	40	272	48	2,28	054272	<b>145,00</b>
-----	-----	----	----	-----	----	------	--------	---------------

**N**ovedad  
en  
Buvcat



250	250	75	36	322	48	3,70	054286	<b>178,00</b>
-----	-----	----	----	-----	----	------	--------	---------------

**N**ovedad  
en  
Buvcat



300	300	75	36	340	48	5,00	054288	<b>238,00</b>
-----	-----	----	----	-----	----	------	--------	---------------

## Canal colector industrial para interiores en acero inoxidable

Indoor industrial channel drain in stainless steel  
Caniveau collecteur industriel pour intérieurs en acier inoxydable



**N**ovedad  
en  
Buvcat

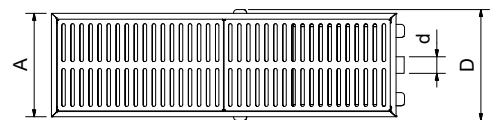
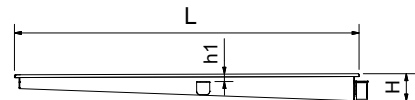

L	A	H	h1	D	d	Kg	Barcode	€
1.000	300	75	22	322	48	10,00	054290	<b>465,00</b>
1.484	300	75	22	322	48	15,00	054292	<b>582,00</b>
2.448	300	75	22	322	48	24,00	054296	<b>838,00</b>

# Sistema modular de canal ranurado

Slot channel, modular concept  
Système modulaire de canal avec rainures



## Sumidero para canal modular ranurado de salida vertical convertible a horizontal 200x200 mm.

Floor drain for slot channel with vertical outlet convertible to horizontal, 200x200 mm.

Siphon pour caniveau modulaire à fentes avec sortie verticale transformable en horizontale 200x200 mm.



**N**ovedad  
ew  
ovenaar

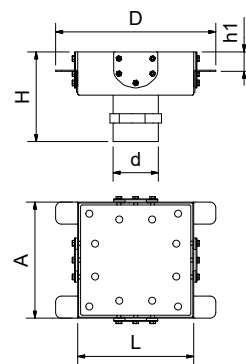

L	A	H	h1	D	d	Kg	Barcode	€
200	200	155	34	275	78	3,00	054260	<b>160,00</b>

## Tramo para canal modular o canalina

Section of 850 mm. for modular channel

Section pour caniveau modulaire ou caniveau 850 mm.



**N**ovedad  
ew  
ovenaar

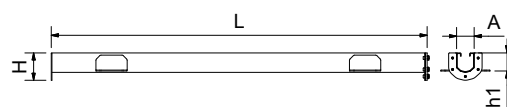

L	A	H	h1	Kg	Barcode	€
850				1,60	054264	<b>47,00</b>
1.700	40	62	41	3,00	054266	<b>67,00</b>



# GRIFERIA

TAPS AND FITTINGS  
ROBINETTERIE

## NOVEDADES

NEWS  
NOUVEAUTÉS



250



250



250



258



259



260



260



262



263



265



265



272



273





## Grifos ducha de sobremesa



Deck mounted pre-rinse units

Robinets douchettes sur table



	463068	463054	463056	463046	463090	463076
Serie	Basic	RD	RD	LV	LV	EXT
L	450	450	450	450	450	450
H	1.200	1.300	1.300	1.300	1.300	1.050
D	1/2"	1/2"	1/2"	1/2"	1/2"	1/2"
	17	17	17	17	17	17
	80°C	80°C	80°C	80°C	80°C	80°C
	4,15	4,40	4,42	4,50	5,70	4,00
	<b>167€</b>	<b>201€</b>	<b>207€</b>	<b>225€</b>	<b>308€</b>	<b>475€</b>



	463070	463058	463060	463048	463092	463078
Serie	Basic	RD	RD	LV	LV	EXT
L	450	450	450	450	450	250
H	1.200	1.300	1.300	1.300	1.300	1.050
D	1/2"	1/2"	1/2"	1/2"	1/2"	1/2"
	17	17	17	17	17	17
	80°C	80°C	80°C	80°C	80°C	80°C
	4,95	5,20	5,26	5,60	6,80	5,00
	<b>232€</b>	<b>273€</b>	<b>269€</b>	<b>290€</b>	<b>370€</b>	<b>535€</b>

## Grifos ducha de sobremesa monomando

Deck mounted single lever pre-rinse units

Robinets douchettes sur table mitigeur



	463086	463074	463072
Serie	MNE	MN	MN
L	450	450	450
H	1.300	1.300	1.300
D	1/2"	3/8"	1/2"
	17	17	17
	80°C	80°C	80°C
	5,11	4,80	5,00
	<b>266€</b>	<b>275€</b>	<b>825€</b>





	463088	463062	463052	463094
Serie	MNE	Monoblock	MNX	Monoblock
L	450	450	230	450
H	1.300	1.300	900	1.300
D	1/2"	1/2"	3/8"	1/2"
	17	17	18	17
	80°C	80°C	80°C	80°C
	5,91	5,90	5,80	5,90
	<b>335€</b>	<b>339€</b>	<b>409€</b>	<b>495€</b>

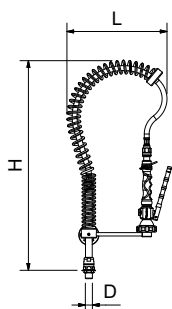

## Grifos ducha de sobremesa extra bajos

Short deck mounted pre-rinse units  
Robinets douchettes sur table extra bas

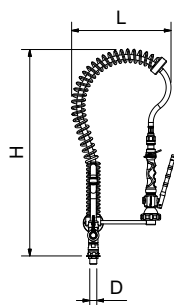

	463034	463080	463038
Serie	Basic	RD	MN
L	450	450	450
H	600	600	600
D	1/2"	1/2"	1/2"
 1/4"	17	17	17
 80°C	80°C	80°C	80°C
 Kg	3,60	3,50	3,70
	<b>208€</b>	<b>245€</b>	<b>319€</b>





	463036	463081	463040	463032
Serie	Basic	RD	MN	Monoblock
L	450	450	450	450
H	600	600	600	600
D	1/2"	1/2"	1/2"	1/2"
 1/4"	17	17	17	17
 80°C	80°C	80°C	80°C	80°C
 Kg	4,90	4,00	4,20	5,60
	<b>266€</b>	<b>297€</b>	<b>371€</b>	<b>369€</b>

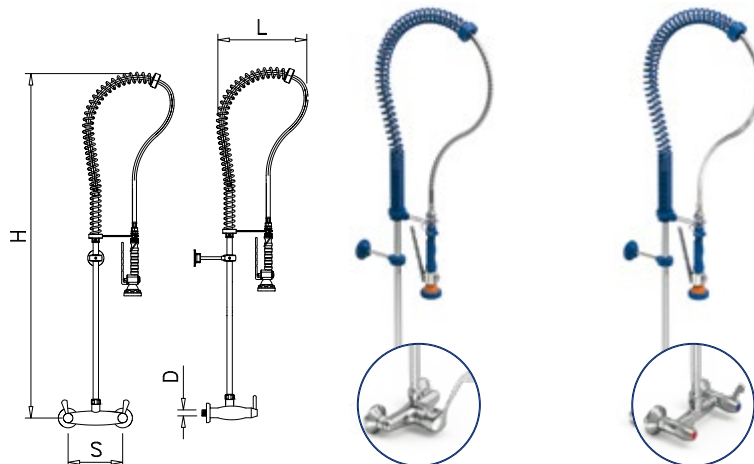

## Grifos ducha murales

Wall-mounted pre-rinse units  
Robinets douchettes muraux

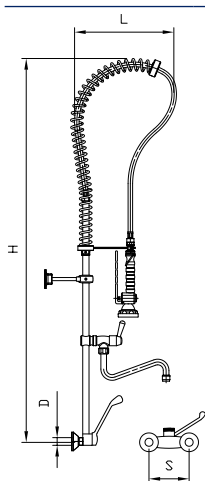

	463064	463042
Serie	MN	LV
L	450	450
H	1.250	1.250
D	1/2"	1/2"
S	150	150
	17	17
	4,60	5,70
	<b>295€</b>	<b>229€</b>



	463066	463044	463096	463098
Serie	MN	LV	Monoblock	Monoblock
L	450	450	450	450
H	1.250	1.250	1.250	600
D	1/2"	1/2"	1/2"	1/2"
S	150	150	150	150
	17	17	20	20
	5,40	6,80	4,70	4,70
	<b>360€</b>	<b>285€</b>	<b>505€</b>	<b>577€</b>

**Expositor central de grifería**  
Centre taps and shower display  
Exposant de robinetterie centrales



Se pueden exponer 8 grifos por nivel.  
8 taps on each level.  
8 robinets par niveau.



El precio no incluye la grifería.  
Taps not included in the price.  
Le prix n'inclut pas la robinetterie.

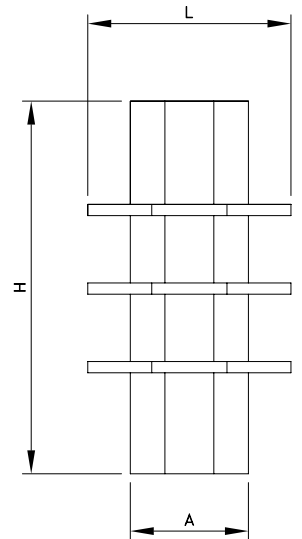

L	A	H	Kg	Barcode	€
1.690	530	2.300	44,00	064402	<b>915,00</b>

**Expositor mural de grifería**  
Wall mounted taps and shower display  
Exposant de robinetterie mural

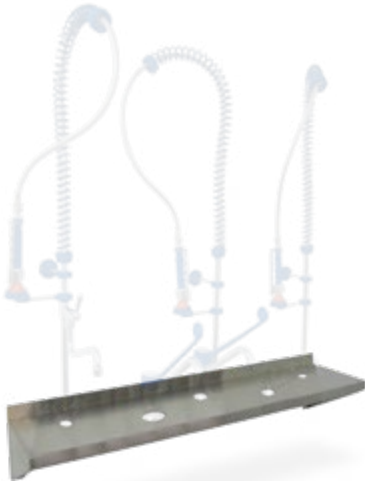

Se pueden exponer 5 grifos por nivel.  
5 taps on each level.  
5 robinets par niveau.



El precio no incluye la grifería.  
Taps not included in the price.  
Le prix n'inclut pas la robinetterie.

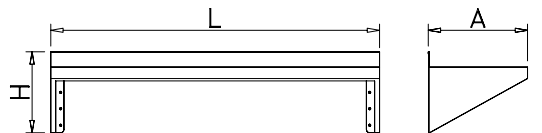

L	A	H	Kg	Barcode	€
1.250	300	245	4,00	064404	<b>175,00</b>

**Expositor mural de grifería con grifos**  
Wall-mounted display with pre-rinse units and taps  
Exposant de robinetterie mural avec robinet



463056  
463060  
463062  
463214  
463602

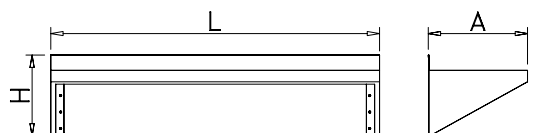

L	A	H	Kg	Barcode	€
1.250	300	245	23,00	970980101	<b>1.177,00</b>



### Grifo ducha sobremesa serie doméstico con piña

Domestic shower fitting with head

Robinet douche modèle domestique avec pomme de douche

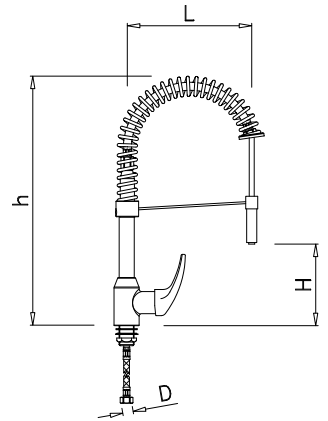

L	H	h	D	WATER	TEMP	Kg	Barcode	€
230	150	500	1/2"	17	80°C	3,50	463051	<b>290,00</b>

### Grifo sobremesa de un agua serie 1/4 de vuelta

Single inlet 1/4 turn model table tap

Robinet à une eau sur table modèle 1/4 de tour

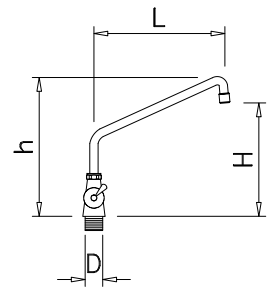

L	H	h	D	WATER	Kg	Barcode	€
250	230	290	1/2"	16	1,00	463426	<b>90,00</b>

### Grifo cocina monomando sobremesa de acero inoxidable

Stainless steel single lever kitchen tap

Robinet de cuisine

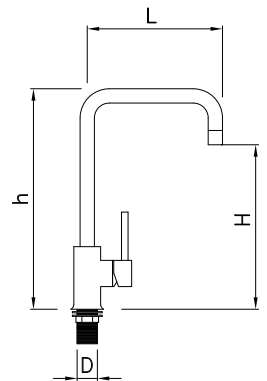

L	H	h	D	WATER	Kg	Barcode	€
180	290	355	1/2"	9,5	2,00	465206	<b>77,00</b>

### Grifo cocina monomando sobremesa cuello de cisne de acero inoxidable

Stainless steel single lever gooseneck tap

Robinet mélangeur sur table avec col de cygne en acier inoxydable

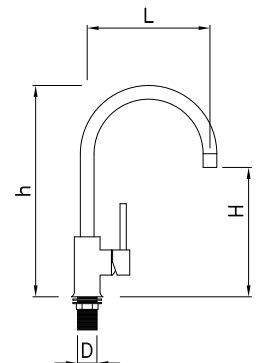

L	H	h	D	WATER	Kg	Barcode	€
180	230	320	3/8" - 1/2"	9,5	3,00	465210	<b>71,00</b>

## Grifo monomando sobremesa caño alto para fregadero

Single lever sink tap, high spout  
Mélangeur évier col de cygne haut

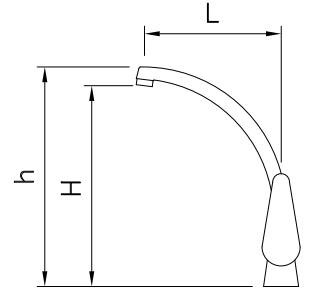

L	H	h	D					€
190	260	290	3/8"	16	0,89	464624		<b>69,00</b>

## Grifo ducha monomando sobremesa dos aguas serie doméstico

Double inlet single lever shower fitting, domestic series  
Robinet douche sur table à deux eaux modèle domestic

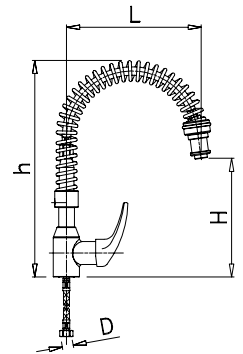

L	H	h	D					€
230	235	415	1/2"	18	80°C	4,00	463050	<b>210,00</b>

## Grifo monomando sobremesa extensible de codo

Double inlet single lever pull out tap, elbow functioning  
Robinet monocommande à coude, douche extensible



Longitud de manguera: 1,5 mts.  
Hose length: 1,5 mts.  
Longueur du tuyau: 1,5 mts.

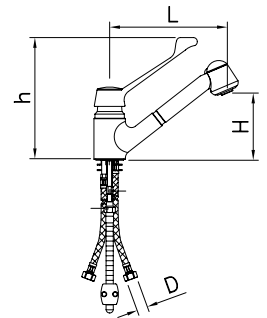

L	H	h	D				€
200	105	250	1/2"	18	3,00	463206	<b>155,00</b>

## Grifo monomando sobremesa extensible de codo leva larga

Double inlet single lever pull out tap, elbow functioning with long handle  
Robinet mitigeur douchette extractible pomme longue



Longitud de manguera: 1,5 mts.  
Hose length: 1,5 mts.  
Longueur du tuyau: 1,5 mts.

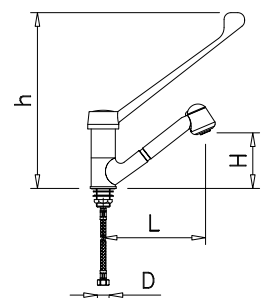

L	H	h	D				€
200	110	290	1/2"	13	1,40	463236	<b>108,00</b>

### Grifo monomando sobremesa de codo dos aguas

Double inlet single lever tap, elbow functioning  
Robinet monocommande à coude pour deux eaux

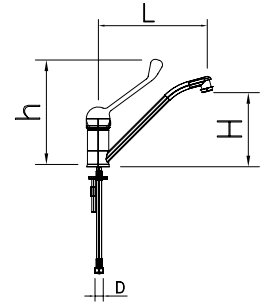

L	H	h	D				€
200	110	170	3/8"	17	1,16	463204	<b>49,00</b>

### Grifo monomando sobremesa de codo dos aguas serie monoblock

Double inlet single lever elbow functioning tap, monoblock series  
Robinet monocommande à coude pour deux eaux modèle monoblock

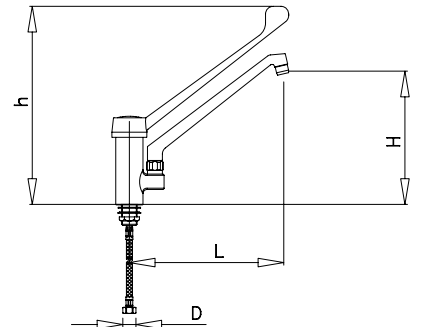

L	H	h	D				€
250	160	380	1/2"	22	2,46	463214	<b>149,00</b>

### Grifo monomando sobremesa giratorio dos aguas

Double inlet rotating mixer tap  
Robinet monocommande giratoire deux eaux

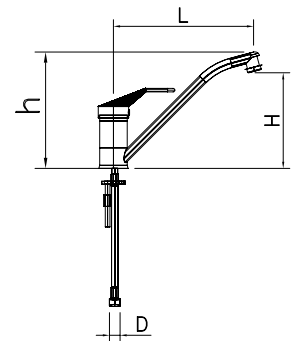

L	H	h	D				€
200	110	130	3/8"	17	1,19	463602	<b>38,00</b>

### Grifo monomando sobremesa caño giratorio elevado

Single lever tap with high rotating spout  
Robinet monocommande sur table avec jet giratoire élevé

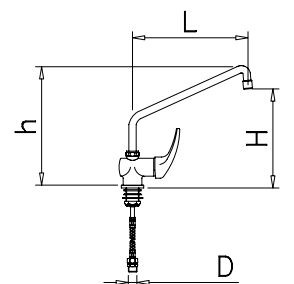

L	H	h	D				€
300	280	350	3/8"	17	2,06	463226	<b>137,00</b>

### Grifo de cocina efecto granito

Granite effect kitchen tap  
Robinet de cuisine effet granit



Novedad  
Nouvel

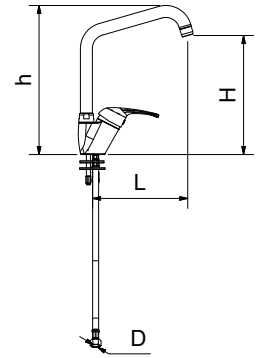

L	H	h	D	Water Filter	Temp. Control	Color	Kg	Barcode	€
300	265	325	3/8"	17	80°C		1,70	464632	253,00
								464633	

### Grifo monomando sobremesa de codo dos aguas serie monoblock-elevado

Double inlet single lever elbow functioning tap, high monobloc series  
Robinet monocommande à coude pour deux eaux modèle monoblock-haut

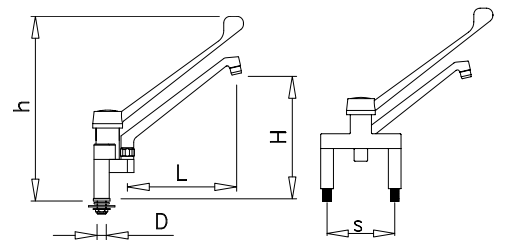

L	H	h	D	S	Water Filter	Kg	Barcode	€
200	210	520	1/2"	155	22	3,83	463216	215,00

### Grifo monomando sobremesa para fregadero serie Ecológica

Single lever sink tap, Eco series  
Mélangeur de table série écologique pour évier

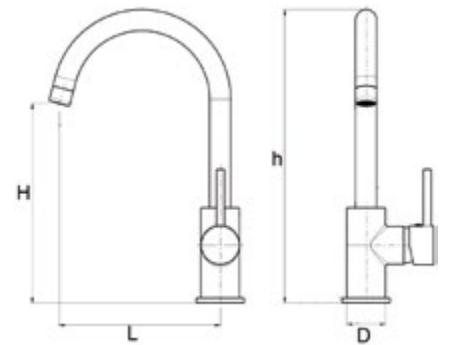

L	H	h	D	Water Filter	Kg	Barcode	€
190	220	320	3/8"	7	0,8	464629	75,00

### Grifo monomando sobremesa dos aguas caño frontal

Double inlet worktop mixer tap with front spout  
Mitigeur de table 2 eaux avec bec frontal



Novedad  
Nouvel

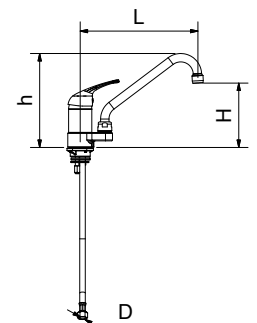

L	H	h	D	Water Filter	Temp. Control	Kg	Barcode	€
253	140	200	3/8"	17	80°C	1,2	463242	93,50

## Grifos giratorios sobremesa dos aguas

Double inlet rotating tap  
Robinet giratoire deux eaux

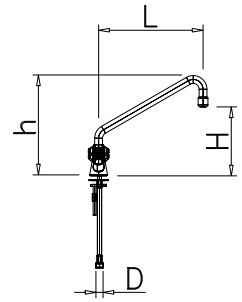

L	H	h	D				€
200	185	240	1/2"	21	1,45	463402	<b>68,00</b>
250	200	250	1/2"	21	1,43	463404	<b>70,00</b>
300	200	260	1/2"	21	1,51	463406	<b>73,00</b>

## Grifo giratorio sobremesa dos aguas serie 1/4 de vuelta

1/4 turn model double inlet rotating tap  
Robinet giratoire deux eaux modèle 1/4 de tour

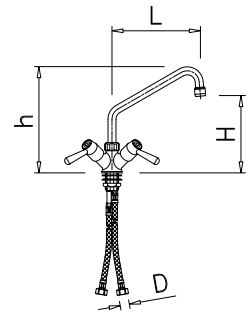

L	H	h	D				€
250	200	260	1/2"	21	1,25	463420	<b>97,00</b>

## Grifo mezclador sobremesa con mandos 1/4 de vuelta

Quarter turn lever mixer tap  
Robinet mitigeur modèle 1/4 de tour

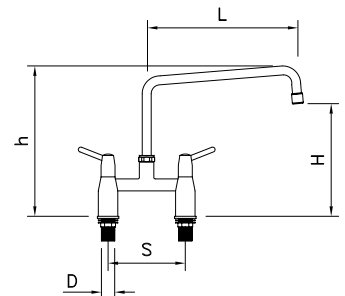

L	H	h	D	S				€
250	230	290	1/2"	155	17	1,85	463430	<b>160,00</b>

## Grifo monomando sobremesa de codo elevado

Elevated straight spout single lever tap  
Robinet monocommande à jet haut

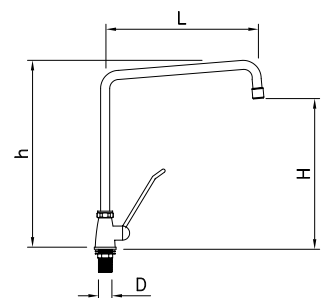

L	H	h	D				€
300	300	360	3/8"	18	1,65	463227	<b>150,00</b>

## Grifo cocina sobremesa doble función de acero inoxidable

Stainless steel double function single lever kitchen tap  
Robinet monocommande à double usage en acier inoxydable



Leva agua independiente (izquierda)  
Filter lever (left side)  
Manette eau speciale (a gauche)



Conducto de agua independiente  
Separated pipe filter water  
Conduite d'eau spéciale

Leva monomando mezcla (derecha)  
Mixer level (right side)  
Manette monocommande melanger (a droite)

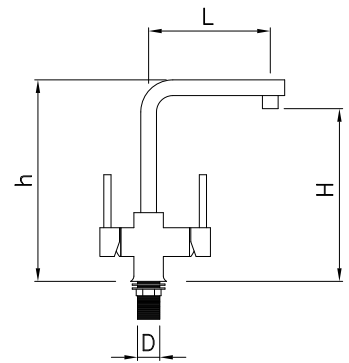

L	H	h	D	W	Kg	Barcode	€
220	280	310	1/2"	9,5	2,00	463222	121,00

## Grifo giratorio extrabajo un agua

One-inlet tap, with low profile rotating spout  
Robinet giratoire extra-bas à une eau

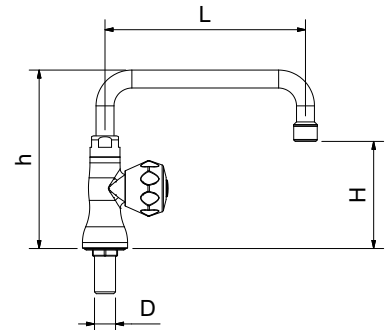

L	H	h	D	W	Kg	Barcode	€
300	110	180	1/2"	22	0,80	463438	69,00

## Grifo giratorio extrabajo dos aguas

Double-inlet tap, with low profile rotating spout  
Robinet giratoire extra-bas à deux eaux

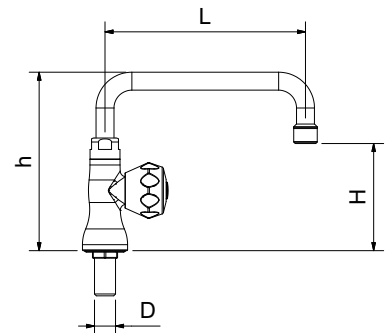

L	H	h	D	W	Kg	Barcode	€
300	55	125	1/2"	22	1,50	463440	76,00

## Grifo giratorio sobremesa dos aguas 1/4 de vuelta caño bajo

Double-inlet 1/4 turn tap, with low profile rotating spout  
Robinet giratoire bas 1/4 de tour à deux eaux

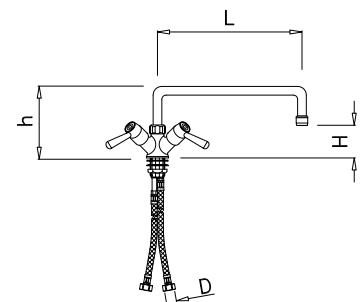

L	H	h	D	W	Kg	Barcode	€
300	70	145	1/2"	21	1,50	463422	92,00

### Grifo giratorio sobremesa dos aguas serie extra bajo

Double-inlet tap, with low profile rotating spout  
Robinet giratoire deux eaux modèle extra-bass

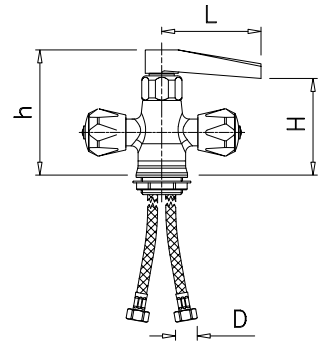

L	H	h	D	mm	Kg	Barcode	€
120	120	160	1/2"	17	2,66	463220	<b>145,00</b>

### Grifo monomando sobremesa con caño bajo

Single lever tap, with low profile spout  
Robinet monocommande jet bas

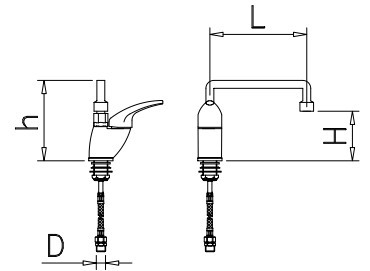

L	H	h	D	mm	Kg	Barcode	€
200	80	140	1/2"	21	1,25	463428	<b>140,00</b>

### Grifo giratorio sobremesa 1/4 vuelta un agua caño bajo

Single inlet 1/4 turn rotating tap, low spout  
Robinet tournant 1/4 tour une eau bec de robinet bas

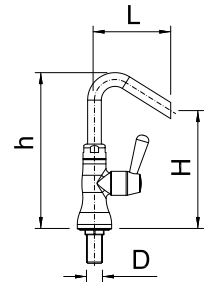

L	H	h	D	mm	Kg	Barcode	€
100	145	200	1/2"	22	1,20	463436	<b>89,00</b>

### Grifo mural dos aguas 1/4 de vuelta caño bajo

Double inlet wall-mounted 1/4 turn tap, with low profile spout  
Robinet tournant mural 1/4 tour deux eaux

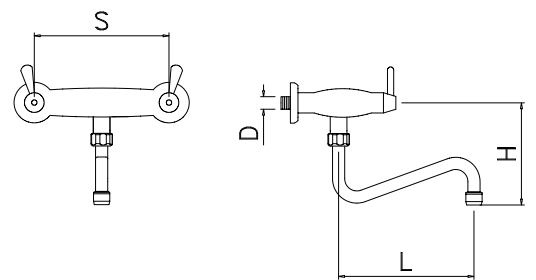

L	H	D	S	mm	Kg	Barcode	€
250	120	1/2"	150	20	1,50	463432	<b>100,00</b>

### Grifo mural dos aguas cuarto de vuelta

Double inlet wall-mounted 1/4 turn tap  
Robinet mural à deux eaux modèle 1/4 de tour

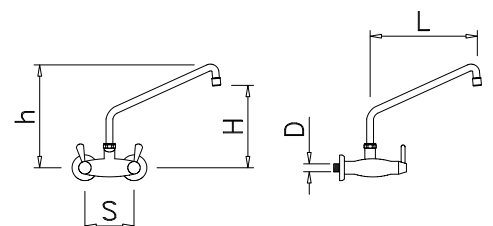

L	H	h	D	S	mm	Kg	Barcode	€
250	175	240	1/2"	150	18	1,60	463424	<b>99,00</b>

### Grifo mural de codo un agua

Single inlet angled tap  
Robinet à coude une eau

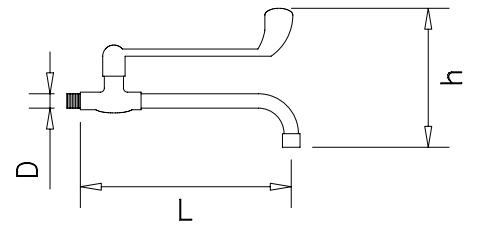

L	h	D	litros/min	Kg	Barcode	€
250	200	1/2"	25	0,65	463202	<b>61,00</b>

### Grifo monomando mural de codo dos aguas serie monoblock-elevado

Double inlet wall-mounted single lever elbow functioning tap, high Monobloc series  
Robinet de mur monocommande à coude pour deux eaux modèle monoblock-elevado

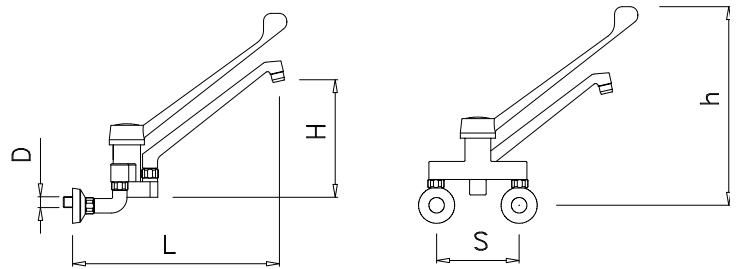

L	H	h	D	S	litros/min	Kg	Barcode	€
300	130	430	1/2"	150	22	3,89	463218	<b>225,00</b>

### Grifo monomando mural de codo dos aguas serie monoblock-bajo

Double inlet wall-mounted single lever elbow functioning tap, low Monobloc series  
Robinet mitigeur mural à coude deux eaux série monoblock-bas

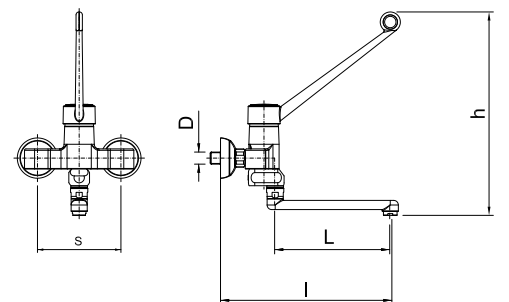

L	l	h	D	S	litros/min	Kg	Barcode	€
300	390	450	1/2"	145	20	4,50	463234	<b>220,00</b>

### Grifo monomando mural de codo para dos aguas

Double inlet wall-mounted single lever elbow functioning tap  
Robinet de mur monocommande à coude pour deux eaux

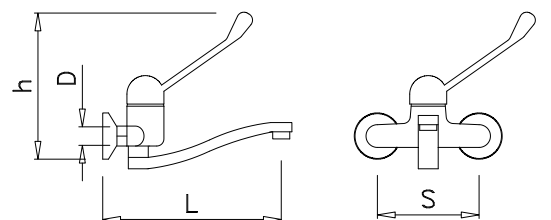

L	h	D	S	litros/min	Kg	Barcode	€
260	230	1/2"	145	20	1,48	463208	<b>50,00</b>



**Grifo mural de 1 agua con pomo aislante caño alto**  
 Single inlet long-neck wall tap with insulating tap head  
 Robinet mural à une eau avec tête isolante et mitigeur haut

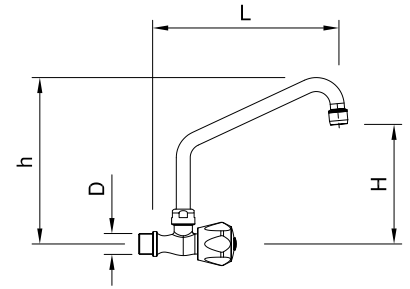

L	H	h	D	litros/min	Kg	Barcode	€
275	160	220	1/2"	25	0,60	463232	<b>63,00</b>

**Grifo mural de 1 agua con pomo aislante caño bajo**  
 Single inlet low-neck wall tap with insulating tap head  
 Robinet mural à une eau avec tête isolante et mitigeur bas

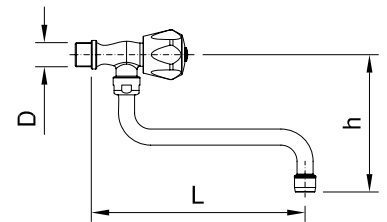

L	h	D	litros/min	Kg	Barcode	€
275	100	1/2"	25	0,60	463230	<b>63,00</b>

**Grifo de sobremesa dos aguas con pomo aislante**  
 Double inlet table tap with insulating head  
 Robinet sur table à deux eaux avec tête isolante

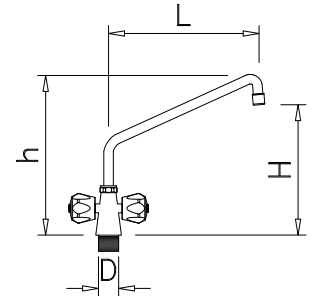

L	H	h	D	litros/min	Kg	Barcode	€
400	370	440	1/2"	18	2,90	463224	<b>155,00</b>

**Grifo de columna orientable sobremesa pomo aislante**  
 Double inlet retractable pot filler tap with insulating head  
 Robinet orientable sur colonne manette isolante

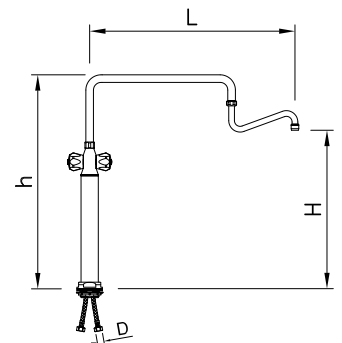

L	H	h	D	litros/min	Kg	Barcode	€
650	500	660	1/2"	23	4,00	463229	<b>385,00</b>

### Grifo columna sobremesa 2 aguas pomo aislante

Double inlet pot filler tap with insulating head  
Robinet colonne 2 eaux poignée isolante

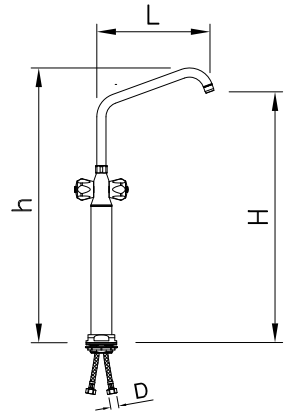

L	H	h	D	Temp	Temp	Kg	Barcode	€
300	620	700	1/2"	21	80°C	6,00	463238	<b>355,00</b>

### Grifo de columna orientable sobremesa de un agua

One inlet retractable pot filler tap  
Robinet orientable sur colonne à une eau

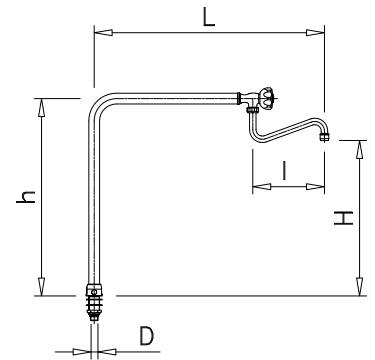

L	h	D	I	H	Temp	Kg	Barcode	€
650	550	1/2"	200	430	25	2,80	463210	<b>166,00</b>
700	700	1/2"	250	600	25	3,10	463212	<b>168,00</b>

### Grifo monomando sobremesa de columna

Single lever pot filler tap  
Robinet monocommande sur colonne

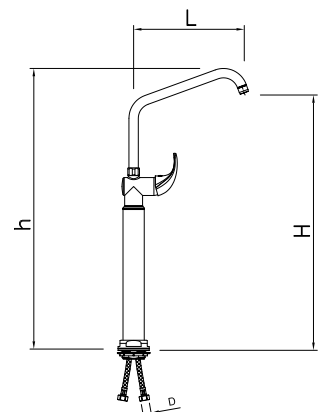



L	H	h	D	Temp	Kg	Barcode	€
285	680	750	1/2"	21	6,00	463228	<b>280,00</b>

## Grifo de columna orientable sobremesa 2 aguas monomando

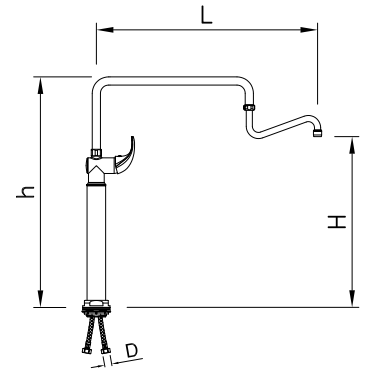
Double inlet single lever retractable pot filler tap  
Robinet orientable sur colonne à deux eaux



L	H	h	D				€
650	500	675	1/2"	24	5,00	463213	<b>366,00</b>

## Válvula desagüe de 1 1/2" para marmita

1 1/2" drain for pots  
Drainage de 1 1/2" pour marmites

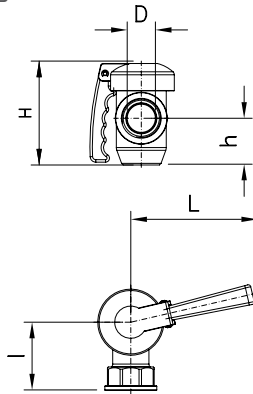

L	H	h	I	D			€
155	130	60	85	1 1/2"	2,50	464802	<b>175,00</b>

## Válvula desagüe de 2" para marmita

2" drain for pots  
Drainage de 2" pour marmites

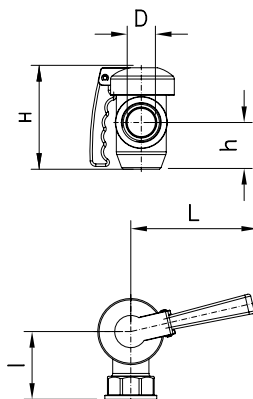

L	H	h	I	D			€
185	160	65	90	2"	2,50	464804	<b>200,00</b>

## Válvula desagüe de 1" para marmita

1" drain for pots  
Drainage de 1" pour marmites

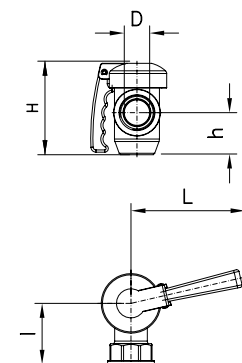

L	H	h	I	D			€
120	95	50	55	1"	1,00	464806	<b>112,00</b>

## Grifo Clinic Expert

Expert Clinic tap  
Robinet Expert Clinic



### Características:

El funcionamiento "sin contacto", facilita una mayor higiene al lavarse las manos así como una fácil limpieza del lavabo. Sus materiales inhibidores de gérmenes y el enjuague higiénico ayudan a evitar la indeseable germinación. El caudal de agua libre de plomo y bacterias cumple con todas las nuevas normas de agua potable.

### Characteristics:

The operation "Touchless" enables the highest hygiene when washing your hands as well as an easy clean of the basin. Its anti-sprouting materials and its hygienic shape will avoid the presence of pathogens. Lead-free and antibacterial spout that will allow the user meet the latest drinking water regulations.

### Caractéristiques:

L'opération "Touchless" permet plus d'hygiène dans le lavage les mains, ainsi que un nettoyage plus facile du bassin. Ses matériaux inhibiteurs de germination et sa forme hygiénique permettra d'éviter la présence de pathogènes. Sans plomb et avec le bec antibactérien qui permet à l'utilisateur de répondre aux dernières normes de l'eau potable.

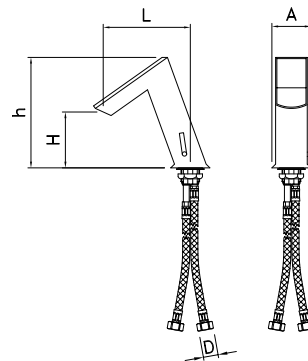

 **Funcionamiento a pilas (no incluidas)**  
Batteries functioning (Not included)  
Fonctionnement a piles (non inclus)

L	H	h	A	D	Kg	Barcode	€
147	94	178	63	3/8"	1,90	460809	<b>890,00</b>

## Grifo monoblock electrónico con selector de temperatura. Funcionamiento a pilas

Electronically-operated monoblock tap with temperature selector. Battery operated

Robinet électronique monobloc avec sélecteur de température. Fonctionnement à piles



 **Funcionamiento a pilas (no incluidas)**  
Batteries functioning (Not included)  
Fonctionnement a piles (non inclus)

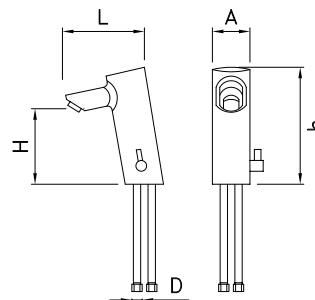

L	A	H	h	D	Temp	Kg	Barcode	€
140	53	130	190	1/2"	15	3,50	460806	<b>125,00</b>

## Grifo de cocina inteligente contactless con selector de temperatura

Smart contactless kitchen faucet with temperature adjustment

Robinet de cuisine intelligent sans contact avec sélecteur de température



 **Funcionamiento a pilas (no incluidas)**  
Batteries functioning (Not included)  
Fonctionnement a piles (non inclus)

Video

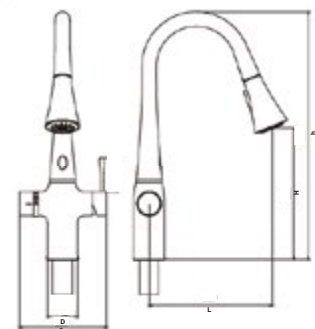

L	H	h	S	Temp	Kg	Barcode	€
210	230	426	150	6,3	3,50	460804	<b>327,00</b>

**Grifo de sobremesa electrónico**  
 Electronically battery-operated tap  
 Robinet sur table électronique

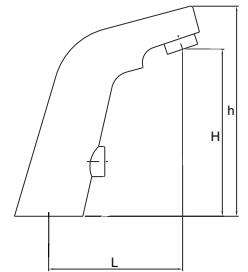

L	H	h					€
98	122	154	15	60	1,80	460802	<b>224,00</b>

**Grifo sobremesa electrónico de acero inoxidable**  
 Stainless steel electronically-operated faucet, high spout  
 Robinet électronique col de cygne haut d'acier inoxydable



**Funcionamiento a pilas (no incluidas)**  
 Batteries functioning (Not included)  
 Fonctionnement a piles (non inclus)

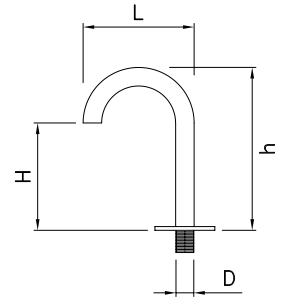

L	H	h	D				€
125	130	205	1/2"	15	1,80	060804	<b>135,00</b>

**Grifo mural electrónico. Funcionamiento a pilas**  
 Electronically-operated wall tap. Battery operated  
 Robinet électronique au mur. Fonctionnement à piles



**Funcionamiento a pilas (no incluidas)**  
 Batteries functioning (Not included)  
 Fonctionnement a piles (non inclus)

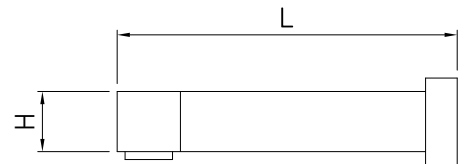

L	H	D				€
220	35	1/2"	15	1,20	460808	<b>171,00</b>

**Caño fijo**  
 Fixed spout  
 Jet fixe

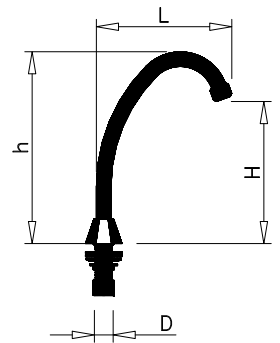

L	H	h	D			€
130	180	245	1/2"	420	461002	<b>55,00</b>

**Caño giratorio de acero inoxidable**  
 Stainless steel rotating spout  
 Jet giratoire d'acier inoxydable

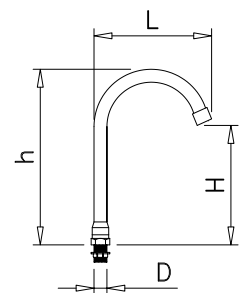

L	H	h	D			€
180	180	270	1/2"	246	461008	<b>42,00</b>

### Caño giratorio extra bajo

Low profile rotating spout  
Giratoire extra bas

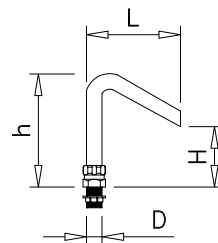

L	h	D	H	Gr	Barcode	€
113	130	1/2"	70	280	461010	<b>47,00</b>

### Caño ducha extraible

Pull-out sprayer spout  
Jet detachable pour douche



Longitud del latiguillo 1.200 mm.  
Hose length 1,200 mm.  
Longueur du flexible 1.200 mm.

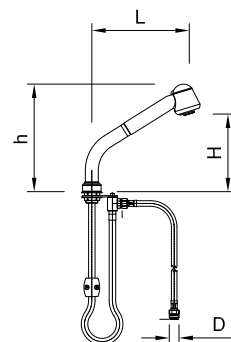

L	H	h	D	litros/min	Kg	Barcode	€
210	167	230	3/8"	18	1,00	462862	<b>180,00</b>

### Caño mural giratorio

Wall-mounted rotating spout  
Jet mural giratoire

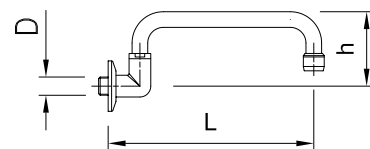

L	h	D	litros/min	Gr	Barcode	€
330	110	1/2"	17	350	461012	<b>65,00</b>

### Aireador cromado fijo para grifo

Fixed Chrome aerator for tap  
Aérateur chromé fixe pour robinet

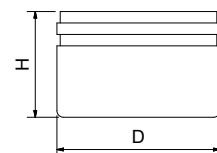

H	D	Gr	Barcode	€
14,5	24	50	461016	<b>1,80</b>

### Aireador cromado orientable para grifo

Pivoting Chrome aerator for tap  
Aérateur chromé réglable pour robinet

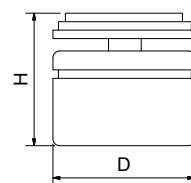

H	D	Gr	Barcode	€
35	24	105	461018	<b>6,00</b>

### Pedal mezclador de agua fría y caliente con palanca de bloqueo H-H-H- 1/2"

H-H-H 1/2" hot and cold water mixer pedal with blocking lever  
Pédale mélangeuse eau froide et chaude H-H-H 1/2" avec levier de blocage



L	A	H	Kg	Barcode	€
350	100	93	2,70	460606	<b>225,00</b>

### Pedal de un agua M-M de 1/2"

M-M 1/2" single inlet water pedal  
Pédale à une eau M-M 1/2"

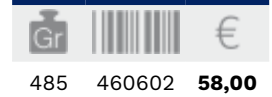

485 460602 **58,00**

### Pedal mezclador de agua fría y caliente M-M-M de 1/2"

M-M-M 1/2" hot and cold-water mixer pedal  
Pédale mélangeuse eau froide et eau chaude M-M-M 1/2"



770 460604 **113,00**

### Pulsador no temporizado M-M de 1/2"

M-M 1/2" self-closing momentary push button  
Bouton-poussoir non temporisé M-M 1/2"

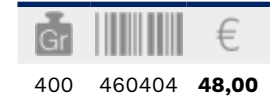

400 460404 **48,00**

### Pulsador temporizado M-M de 1/2"

M-M 1/2" self-closing push button timer  
Bouton-poussoir temporisé M-M 1/2"



220 460432 **60,00**

### Palanca un agua M-M 1/2"

M-M 1/2" self closing lever valve  
Robinet à levier M-M 1/2"

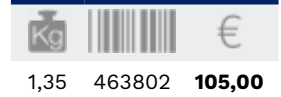

1,35 463802 **105,00**

### Válvula mezcladora termostática H-H-M de 1/2"

H-H-M 1/2" thermostatic mixing valve  
Valve mélangeuse thermostatique H-H-M 1/2"

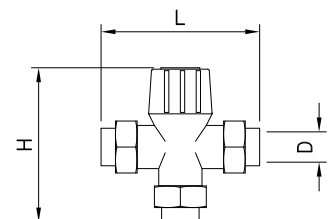

L H D 130 115 1/2" 620 461402 **49,00**

### Válvula mezcladora antiretorno M-H-M de 1/2"

M-F-M 1/2" no-return mixing valve  
Valve mélangeuse antiretour M-H-M 1/2"

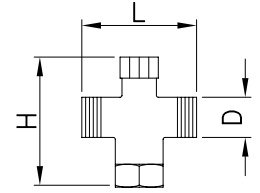

L	H	D	Gr	Barcode	€
60	70	1/2"	150	461604	26,25

### Grifo pulsador para fuente

Push-button tap for fountain  
Robinet poussoir pour fontaine

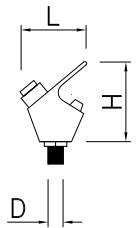

L	H	D	Gr	Barcode	€
65	85	3/8"	10	464250	26,00

### Grifo para fuente de agua sin pulsador

Tap for drinking fountain without push-button  
Robinet pour fontaine sans bouton-poussoir

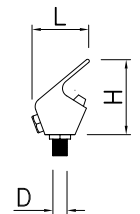

L	H	D	Gr	Barcode	€
50	70	3/8"	10	464248	25,00

### Grifo electrónico inoxidable a pilas para fuente de agua 1/2"

Electronic battery-powered faucet 1/2" in stainless steel for drinking fountain  
Robinet électronique à pile en acier inoxydable pour fontaine à eau 1/2"



**N**ovedad  
en  
Fruitec



Funcionamiento a pilas  
(no incluidas)  
Batteries functioning  
(Not included)  
Fonctionnement a piles  
(non inclus)

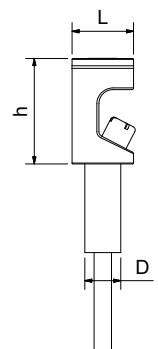

L	h	D	Gr	Barcode	€
35	60	1/2"	8	464258	234,00



### Grifo llenajarras

Bottle filler for drinking fountain  
Robinet pour remplir pots

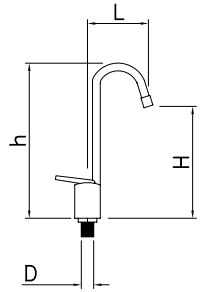

L	H	h	D	litros	Gr	Barcode	€
75	140	220	3/8"	8	130	464252	21,00

### Grifo llenajarras de acero inoxidable

Stainless steel bottle-filler tap  
Robinet de remplissage de pichet d'acier inoxydable

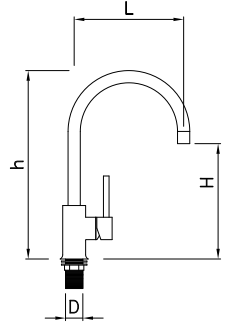

L	H	h	D	Kg	Barcode	€
150	210	275	1/2"	0,13	464256	50,00

### Grifo llenajarras electrónico acero inoxidable para fuente de agua

Stainless steel electronic bottle-filler tap for drinking fountain  
Robinet de remplissage de pichet électronique en acier inoxydable pour fontaine à eau



Funcionamiento a pilas  
(no incluidas)  
Batteries functioning  
(Not included)  
Fonctionnement a piles  
(non inclus)

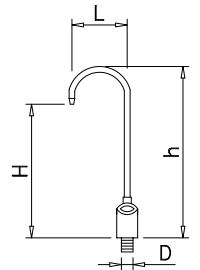

L	H	h	D	Gr	Barcode	€
100	225	295	1/2"	310	464254	265,00

### Ducha de gran alcance H de 1/2"

Long-reach shower  
Douche à grande portée



Longitud del latiguillo 2.000 mm.  
Hose length 2.000 mm.  
Longueur du flexible 2.000 mm.

litros	°C	Gr	Barcode	€
13,5	60°C	900	463002	27,00

### Ducha horno H de 1/2"

Shower for oven  
Douche pour four



Longitud del latiguillo 2.000 mm.  
Hose length 2.000 mm.  
Longueur du flexible 2.000 mm.

litros	°C	Kg	Barcode	€
11	60°C	2,45	463004	78,00

## Ducha horno enrollable H de 1/2"

Roll-up shower for oven  
Douche pour four enrollable

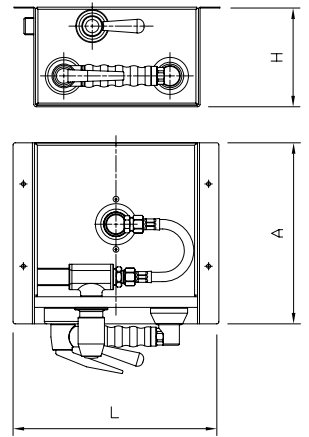

Longitud del latiguillo 1.700 mm.  
Hose length 1.700 mm.  
Longueur du flexible 1.700 mm.

L	A	H					€
250	220	115	10	55°C	5,00	463006	<b>339,00</b>

## Ducha horno enrollable bajo encimera

Under worktop roll-up shower for oven  
Douche enrollable sous plan pour four



Longitud del latiguillo 1.700 mm.  
Hose length 1.700 mm.  
Longueur du flexible 1.700 mm.

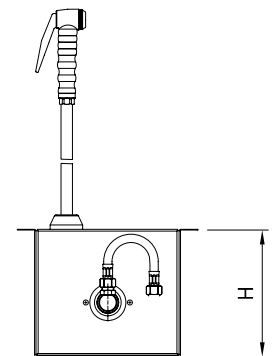
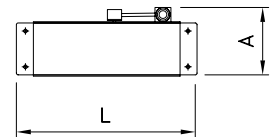

L	A	H	D					€
230	108	200	1/2"	13	55°C	4,00	463008	<b>295,00</b>

## Ducha para horno pulsador

Shower for oven, push button operation  
Douche pour four, fonctionnement à poussoir



Longitud del latiguillo 2.000 mm.  
Hose length 2.000 mm.  
Longueur du flexible 2.000 mm.

				€
11	60°C	2,50	463005	<b>63,00</b>

## Soporte para manguera en acero inoxidable

Stainless steel hose holder  
Support pour tuyau en acier inoxydable

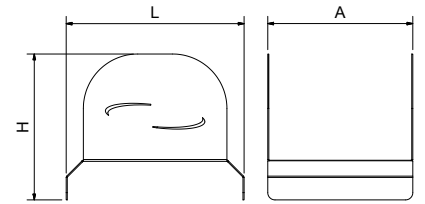

L	A	H	Kg	Barcode	€
245	200	200	1,40	064020	<b>33,00</b>

## Grifo manguera 50 m. con soporte inox y pistola

50 m. faucet hose with stainless steel holder and wash gun  
Robinet tuyau 50 m. avec support inox et pistolet



Longitud de manguera: 50 mts.  
Hose length: 50 mts.  
Longueur du tuyau: 50 mts.



Kg	Barcode	€
14,50	064022	<b>344,00</b>

## Grifo manguera enrollable serie profesional

Roll-up faucet hose, professional series  
Robinet-tuyau d'arrosage enrollable professionnel



Longitud de manguera: 13 mts.  
Hose length: 13 mts.  
Longueur du tuyau: 13 mts.

El precio NO incluye el grifo rociador o piña.  
Faucet not included in the price.  
Le prix ne inclut pas le robinet d'arrosage.

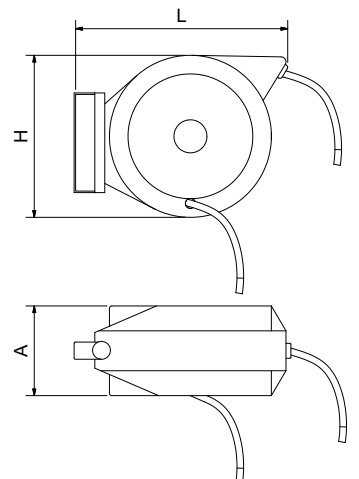

\* Se incluye conexión de 1/2" M.  
1/2" M link included.  
Comprend adaptateur 1/2" M.

L	A	H	Ø	Water	Temp	Kg	Barcode	€
390	175	300	3/8" *	12	55 °C	7,00	064006	<b>196,00</b>

## Grifo manguera enrollable inoxidable serie compacto

Inox roll-up faucet hose, compact series  
Robinet enrouleur inoxydable série compacte



Longitud de manguera: 5 mts.  
Hose length: 5 mts.  
Longueur du tuyau: 5 mts.

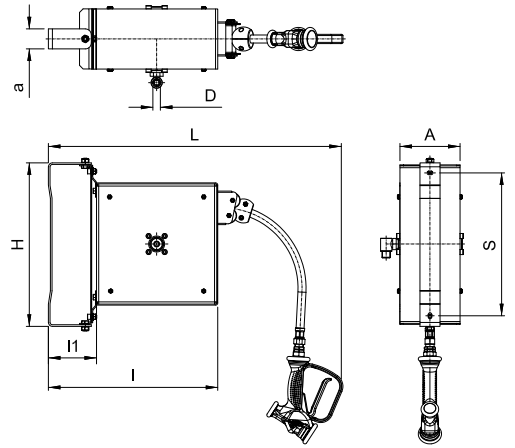

L	I	H	D	S	A	a	I1		Kg		€
730	425	410	1/2"	356	150	50	120	13	11,00	464008	1.099,00

## Grifo manguera enrollable serie profesional plus

Professional plus roll-up faucet hose  
Robinet enrouleur professionnel plus



Longitud de manguera: 5 mts.  
Hose length: 5 mts.  
Longueur du tuyau: 5 mts.

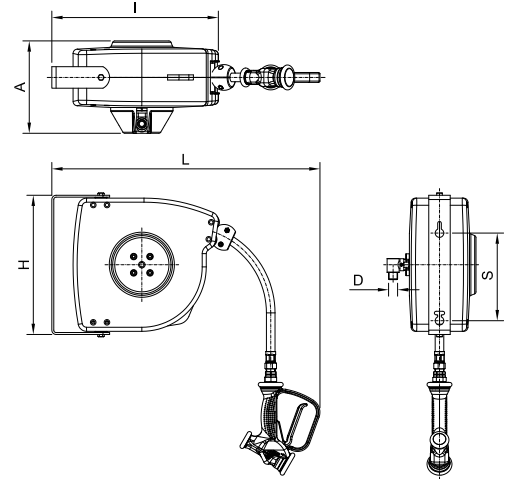

L	I	H	D	S	A		Kg		€
620	390	320	1/2"	204	215	13	7,00	464010	899,00

## Puesto de lavado y desinfección

Sanitising and disinfectant spray system  
Poste de lavage et de désinfection



### Características:

Soporte inox. para 1 garrafa de 5 litros.

### Characteristics:

Inox holder for 5 litres tank

### Caractéristiques:

Support inox pour réservoir de 5 litres

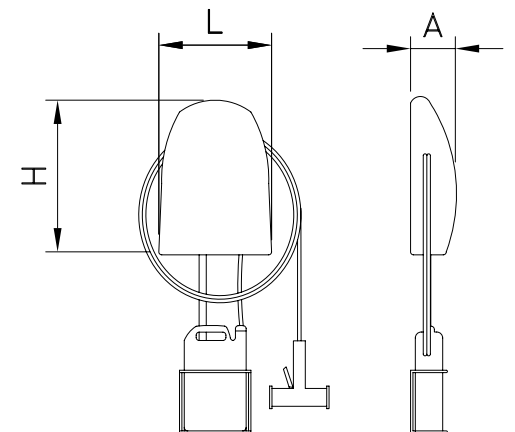

Longitud de manguera: 15 mts.  
Hose length: 15 mts.  
Longueur du tuyau: 15 mts.

L	A	H	Kg		€
350	120	480	2,60	465602	550,00

## Grifo manguera enrollable serie básico

Basic roll-up faucet hose

Robinet-tuyau d'arrosage enrollable basique

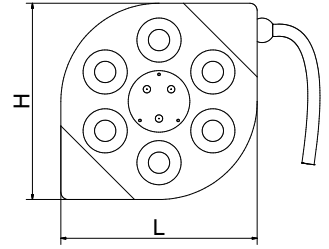
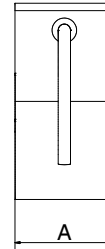

Longitud de manguera: 20 mts.  
Hose length: 20 mts.  
Longueur du tuyau: 20 mts.

L	A	H	∅	Temp	Temp	Kg	Barcode	€
400	200	400	1/2"	12	40°C	11,50	464006	205,00

## Grifo manguera enrollable serie inoxidable

Stainless roll-up faucet hose

Robinet-tuyau d'arrosage enrollable inoxydable



Construcción en acero inoxidable extrafuerte  
Pivotante 180°  
Máxima presión 5 bar

All heavy duty stainless steel construction  
180° pivoting  
Max. press. 5 bar

Construit en acier inoxydable extra-fort  
Pivotement 180°  
Max. press. 5 bar

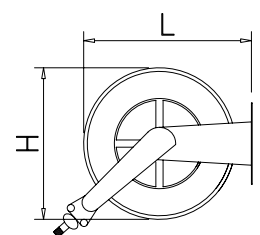
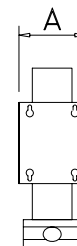

Longitud de manguera: 15 mts.  
Hose length: 15 mts.  
Longueur du tuyau: 15 mts.











El precio incluye el grifo rociador o piña.  
Faucet included in the price.  
Le prix inclut pas le robinet d'arrosage.

L	A	H	∅	Temp	Temp	Kg	Barcode	€
533	235	438	1/2"	13	55°C	22,00	464004	1.162,00

## Accesorios para grifos de manguera

Taps accessories for roll-up faucets

Robinetterie accessoires pour robinet-tuyau d'arrosage

			Gr	Barcode	€
	Adaptador H de 3/8" a M de 1/2" M 3/8" to F 1/2" adaptor Adaptateur M 3/8" - H 1/2"	50	464055	<b>4,00</b>	
	Adaptador H de 1/2" a H de 1/2" F 1/2" to F 1/2" adaptor Adaptateur H 1/2" - H 1/2"	60	464054	<b>4,50</b>	
	Conector rápido universal H1/2" F 1/2" Universal quick connector Connecteur rapide universel F 1/2"	75	464062	<b>33,00</b>	
	Pistola rociadora de pulverización regulable H 1/2" Gun shower F 1/2" Pistolet H 1/2"	970	464058	<b>132,00</b>	
	Pistola con lanza rociadora H 1/2" Pistol and nozzle shower F 1/2" Pistolet et lance F 1/2"	615	064050	<b>140,00</b>	
	Piña para grifo ducha Head shower Douche	700	462806	<b>83,00</b>	
	Piña de acero inoxidable para grifo ducha Stainless steel head shower Douche d'acier inoxydable	700	462807	<b>130,00</b>	
	Piña para grifo ducha serie Ecológica Shower head for pre-rinse unit Eco series Poignée pour robinet douchette série Écologique	700	462890	<b>114,00</b>	
	Piña de repuesto para grifo de accionamiento extensible Spare head shower for faucet with extendable shower Poignée de remplacement pour robinet à actionnement extensible	280	462872	<b>77,00</b>	
	Equilibrador Spring balancer Équilibrateur	500	463030	<b>70,00</b>	

### Monomando lavabo

Single lever mixer for basin  
Mélangeur lavabo

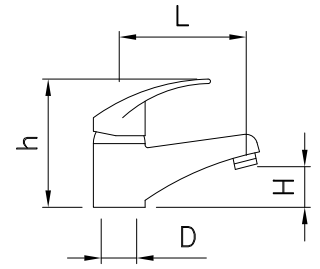

L	H	h	D	Water tap icon	Gr	Barcode	€
110	44	111	3/8"	16	570	464616	39,00

### Grifo monomando para lavabo serie Ecológica

Single lever mixer for basin, Eco series  
Mélangeur de lavabo série écologique

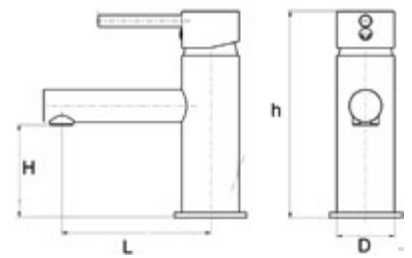

L	H	h	D	Water tap icon	Gr	Barcode	€
120	71	160	3/8"	7	890	464625	66,00

### Grifo para lavabo de 1 agua

One inlet basin tap  
Robinet pour lavabo à une eau

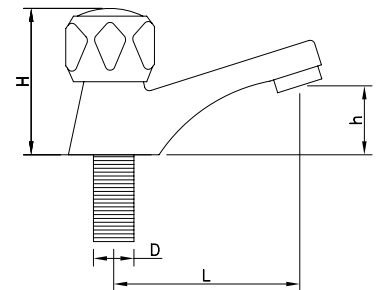

L	H	h	D	Water tap icon	Gr	Barcode	€
80	75	35	1/2"	16	0,25	464608	19,00

### Monomando bidé

Single lever mixer for bidet  
Mélangeur bidet

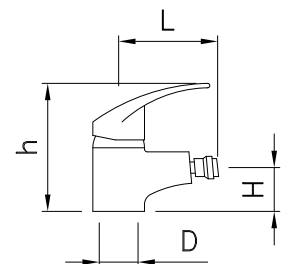

L	H	h	D	Water tap icon	Gr	Barcode	€
95	42	114	3/8"	16	580	464618	39,00

## Grifo monomando para bidé serie Ecológica

Single lever mixer for bidet. Eco series  
Mélangeur de bidet série écologique

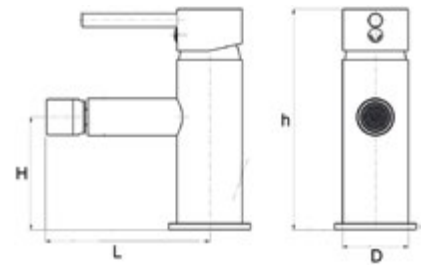

L	H	h	D	Wc mm	Gr	Barcode	€
120	75,5	150	3/8"	7	826	464626	<b>66,00</b>

## Grifo temporizado un agua

One inlet timer tap  
Robinet temporisé à une eau

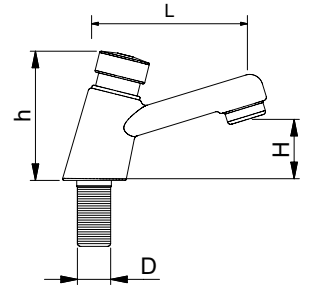

L	H	h	D	Wc mm	Kg	Barcode	€
100	30	80	1/2"	0,67	0,67	464602	<b>64,00</b>

## Grifo temporizado dos aguas

Double inlet timer tap  
Robinet temporisé à deux eaux

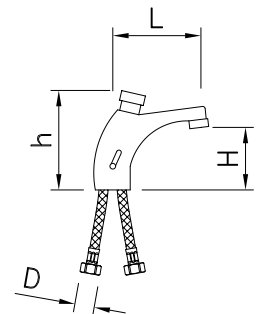

L	H	h	D	Wc mm	Kg	Barcode	€
107	85	125	1/2"	15	1,25	464612	<b>188,00</b>

## Monomando ducha

Single lever mixer for shower  
Mélangeur douche

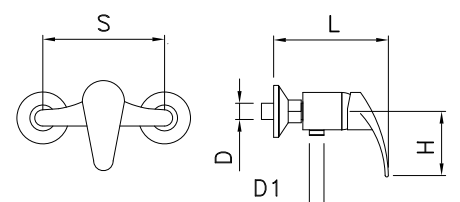

L	H	D	D1	S	Wc mm	Gr	Barcode	€
130	85	1/2"	1/2"	150	17	684	464622	<b>53,00</b>



### Grifo monomando para ducha serie Ecológica

Single lever mixer for shower. Eco series  
Mitigeur de douche série écologique

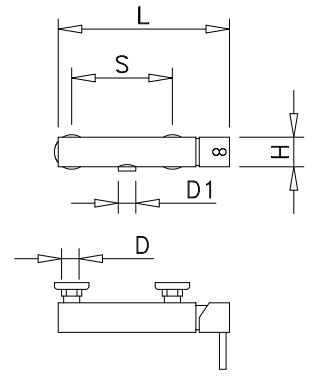

L	H	D	D1	S				€
255	44	1/2"	1/2"	150	7	1,16	464628	<b>100,00</b>

### Monomando baño/ducha

Single lever mixer for bath/shower  
Mélangeur baignoire

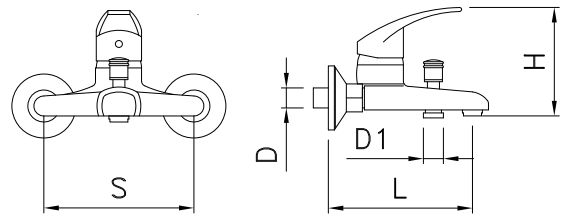

L	H	D	D1	S				€
144	111	1/2"	1/2"	150	17	888	464620	<b>66,00</b>

### Grifo monomando para baño/ducha serie Ecológica

Single lever mixer tap for bath/shower. Eco series  
Mitigeur de baignoire/douche série écologique

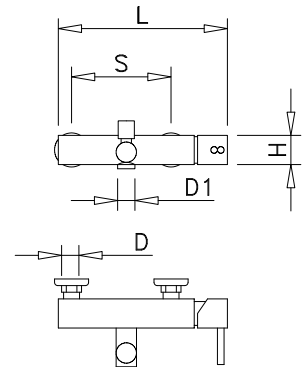

L	H	D	D1	S				€
255	44	1/2"	1/2"	150	7	1,56	464627	<b>127,00</b>

### Conjunto de ducha, grifo monomando y mástil

Wall-mounted rainfall tub shower tap set  
Ensemble robinet douche mitigeur fixation mural

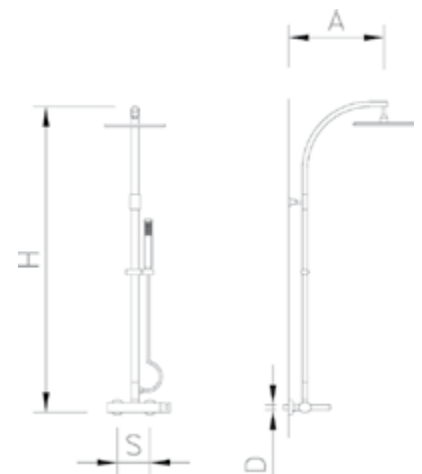

A	H	S	D				€
385	1.300	150	1/2"	6	4,00	465802	<b>472,00</b>

## Conjunto de ducha y pulsador profesional

Professional push-button shower set

Ensemble douche bouton-poussoir professionnelle

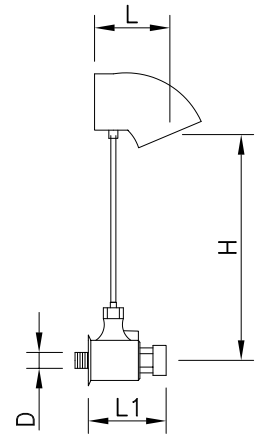

L	L1	H	D	litros/min	°C	Kg	Barcode	€
115	80	860	1/2"	5	80°C	1,80	465804	<b>180,00</b>

## Rociador de ducha

Shower sprayer

Pomme de douche

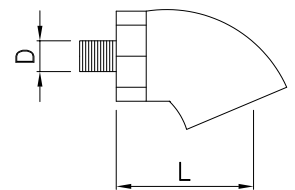

L	D	litros/min	°C	Gr	Barcode	€
60	1/2"	5	80°C	450	465806	<b>41,00</b>

## Ducha higiénica con llave de paso

Hygienic shower with stopcock

Douche hygiénique avec robinet



**N**ovedad  
NEW  
NOUVEAU

### Características:

Esta ducha higiénica con selector monomando es el sustituto ideal para el bidé y la escobilla.

Gracias a su tamaño es perfecta para espacios pequeños y su instalación al lado del inodoro será discreta a la par que útil.

Incorpora un selector monomando y un latiguillo de 1,20m para facilitar su utilización.

### Characteristics:

This hygienic shower with a single-lever selector is the ideal substitute for the bidet and the toilet brush. Thanks to its size, it is perfect for small spaces and its installation next to the toilet will be discreet as well as useful. It is supplied with a 1.20m hose for easy use.

### Caractéristiques:

Cette douche hygiénique avec sélecteur monocommande est le substitut idéal du bidet et de la brosse WC. Grâce à sa taille, il est parfait pour les petits espaces et son installation à côté des toilettes sera aussi discrète qu'utile. Il intègre un sélecteur monocommande et un tuyau de 1,20 m pour faciliter son utilisation.

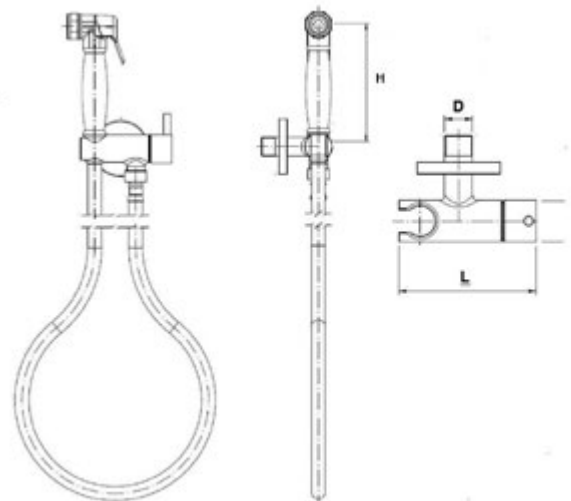

L	H	D	litros/min	Gr	Barcode	€
98,5	36	1/2"	15	812	464614	<b>152,00</b>

## Ducha higiénica serie basic

Basic series hygienic shower  
Douche hygiénique série Basic



### Características:

Esta ducha higiénica de diseño sencillo es el sustituto ideal para el bidé y la escobilla.

Gracias a su tamaño es perfecta para espacios pequeños y su instalación al lado del inodoro será discreta a la par que útil.

Incorpora el latiguillo de 1,20m para facilitar su utilización.

### Characteristics:

This simply designed hygienic shower is the ideal substitute for the bidet and toilet brush. Thanks to its size, it is perfect for small spaces and its installation next to the toilet will be discreet as well as useful. It is supplied with a 1.20m hose for easy use.

### Caractéristiques:

Cette douche hygiénique au design simple est le remplacement idéal d'un bidet et d'une brosse WC.

Grâce à sa taille, il est parfait pour les petits espaces et son installation à côté des toilettes sera aussi discrète qu'utile. Il intègre le tuyau de 1,20 m pour faciliter son utilisation.

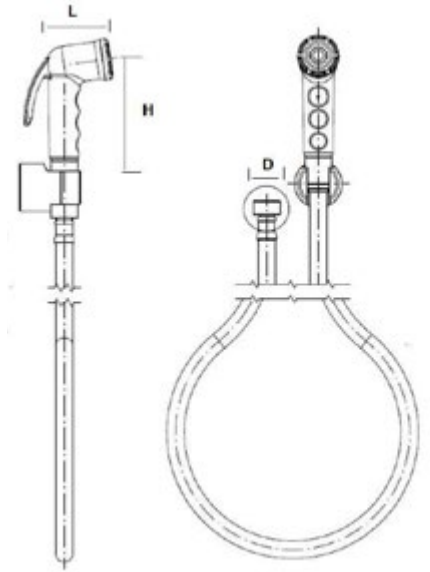

L	H	D	Gr	Barcode	€
55	84,25	1/2"	15	464615	47,00

## Fluxómetro para WC

Flush valve push button for toilets  
Robinet temporise pour WC

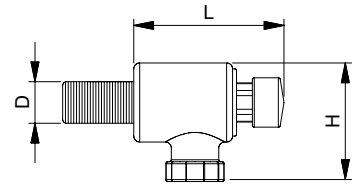

L	H	D	Gr	Barcode	€
100	80	3/4"	900	464606	96,00

## Grifo temporizado para urinario

Flush valve push button for urinals  
Robinet temporise pour urinoirs

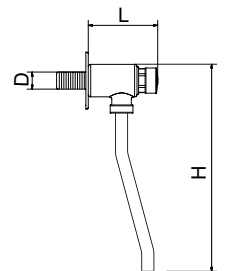

L	H	D	Gr	Barcode	€
72	210	1/2"	400	464604	49,00

## Grifo electrónico temporizado para urinario. Funcionamiento a pilas

Sensor operated flush valve for urinals  
Robinet électronique temporisé pour urinoirs. Fonctionnement à piles



Funcionamiento a pilas  
(no incluidas)  
Batteries functioning  
(Not included)  
Fonctionnement à piles  
(non inclus)

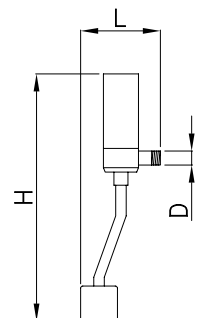



























L	H	D	Kg	Barcode	€
85	310	1/2"	1,20	464610	199,00













## Repuestos para grifos











Spare parts for taps

Pièces de remplacement pour robinets











		Modelo Model Model	Gr	Barcode	€	
	<b>Piña para grifo ducha</b> Head shower Douche		700	462806	<b>83,00</b>	
	<b>Piña de acero inoxidable para grifo ducha</b> Stainless steel head shower Douche d'acier inoxydable		700	462807	<b>130,00</b>	
	<b>Piña para grifo ducha serie Ecológica</b> Shower head for pre-rinse unit Eco series Poignée pour robinet douchette série Écologique		700	462890	<b>114,00</b>	
	<b>Piña de repuesto para grifo de accionamiento extensible</b> Spare head shower for faucet with extendable shower Poignée de remplacement pour robinet à actionnement extensible		280	462872	<b>77,00</b>	
	<b>Juego de muelle y juntas para piña de grifo ducha</b> Spring and joints set for shower head Ensemble de ressort et joints pour poignée de robinet douchette		30	462880	<b>10,00</b>	
	<b>Latiguillo inox. plastificado para grifo ducha</b> Flexible rubber hose inox for shower taps Flexibles en d'acier inoxydable pour robinet douche	800 mm	250	462851	<b>22,00</b>	
		1.100 mm	350	462808	<b>18,00</b>	
		1.200 mm	350	462852	<b>23,00</b>	
		1.500 mm	360	462854	<b>25,00</b>	
		2.000 mm	370	462810	<b>27,00</b>	
	<b>Latiguillos flexibles en malla de acero inoxidable H-H de 1/2"</b> H-H 1/2" stainless-steel flexible hoses Flexibles en maille d'acier inoxydable H-H d'1/2"	400 mm	100	461202	<b>5,25</b>	
		600 mm	120	461206	<b>6,30</b>	
		900 mm	200	461212	<b>8,40</b>	
		1.200 mm	240	461214	<b>7,88</b>	
		1.500 mm	345	461216	<b>9,45</b>	
	<b>Latiguillo de repuesto para grifo 463052</b> Spare hose for faucet 463052 Tuyau de rechange pour robinet 463052		850 mm	220	463084	<b>25,00</b>
	<b>Latiguillo de repuesto para grifo 463220</b> Spare hose for faucet 463220 Tuyau de rechange pour robinet 463220		160	463256	<b>14,50</b>	
	<b>Muelle para grifo ducha</b> Spring for table shower fitting Ressort pour robinet douche		1.200	462804	<b>36,00</b>	
	<b>Mástil para grifo ducha</b> Table shower fitting support Tuyau pour robinet douche	790 mm	930	462802	<b>47,00</b>	
		620 mm	800	462800	<b>45,00</b>	
	<b>Mástil extra corto para grifo ducha</b> Extra-short table shower fitting support Tuyau extra court sur table pour robinet douchew		210 mm	270	462801	<b>35,00</b>

				Modelo Model Model	Gr	€
	<b>Mástil con caño para grifo ducha</b> Table shower fitting support with spout Tuyau pour robinet douche avec jet	790 mm	1.360	462803	<b>113,00</b>	
	<b>Pomo de repuesto para mástil con caño</b> Spare flow knob for table shower fitting support Sélecteur de sortie pour robinet douchette		120	462875	<b>15,00</b>	
	<b>Tope de muelle para grifo ducha</b> Top for table shower fitting spring Arrêt pour robinet douche		140	462805	<b>7,00</b>	
	<b>Tirante, soporte a pared para grifo ducha + soporte piña</b> Wall-rod for shower fitting + shower-head holder Tringle au mur pour robinet douchette + Tringle au mur pour robinet douche		350	462814	<b>26,00</b>	
	<b>Soporte piña modelo apoyar</b> Shower-head holder. Supporting model Support pour poignée. Modèle appui		220	462876	<b>26,00</b>	
	<b>Tirante a pared para grifo ducha 463052</b> Wall-rod for shower fitting 463052 Tringle au mur pour robinet douche 463052		130	462848	<b>35,00</b>	
	<b>Repuesto de tirante a pared y soporte para piña para grifos 463080 y 463081</b> Spare wall support for shower fitting and holder shower head holder for taps 463080 y 463081 Support mural et support poignée de rechange pour robinets 463080 et 463081		495	462882	<b>65,00</b>	
	<b>Tornillo allen M6x12 (tope de muelle y tirante a pared)</b> Allen bolt M6x12 (spring top and wall rod) Vis allen M6x12 (arrêt pour robinet et tringle au mur)		2	462824	<b>0,45</b>	
	<b>Tornillo allen M6x8 (Soporte piña)</b> Allen bolt M6x8 (shower head support) Vis allen M6x8 (support de pomme)		1	462826	<b>0,45</b>	
	<b>Bolsa de tornillería y juntas (repuesto) para grifo ducha</b> Bag with screws and gaskets (spare) for shower tap Sachet de vis et joints (de rechange) pour robinet douchette		10	462827	<b>8,00</b>	
	<b>Tuerca unión mástil y válvula grifo ducha</b> Joint nut for shower fitting support and shower tap valve Écrou de joint pour tuyau et valvule pour robinet douche		40	462816	<b>3,50</b>	
	<b>Juego de juntas para el mástil del grifo ducha</b> Joints set for shower fitting support Conjoint de joints pour tuyau de robinet douche		1	462834	<b>2,10</b>	
	<b>Conjunto sujeción inferior válvula de un agua</b> Lower fixing set for single inlet valve Conjoint de fixation inférieure pour valvule à une eau		35	462836	<b>4,20</b>	
	<b>Conjunto sujeción inferior válvula monomando dos aguas</b> Lower fixing set for double inlet one handle valve Conjoint de fixation inférieure pour valvule monocommande à deux eaux		30	462840	<b>5,50</b>	

	<p><b>Conjunto sujeción inferior válvula dos aguas</b> Lower fixing set for double inlet valve Conjoint de fixation inférieure pour valvule à deux eaux</p>	85	462838	<b>4,50</b>
	<p><b>Conjunto sujeción inferior para válvula 462406</b> Lower fixing set four double inlet one handle valve Conjoint de fixation inférieure pour valvule mitigeur à deux eaux</p>	95	462841	<b>15,00</b>
	<p><b>Acoplamiento de grifo ducha serie basic a encimera</b> Countertop fixing for basic series shower tap Raccord de robinet douchette de la série basic au plan de travail</p>	165	462856	<b>19,00</b>
	<p><b>Latiguillo inferior para grifo ducha dos aguas</b> Lower hose for table double inlet shower fitting Flexible intérieur pour robinet douche à deux eaux</p>	90	462820	<b>8,50</b>
		95	462822	<b>8,50</b>
	<p><b>Palanca para válvula monomando dos aguas</b> Handle for double inlet one handle valve Commande pour valvule monocommande à deux eaux</p>	130	462842	<b>11,00</b>
	<p><b>Palanca repuesto para válvulas 462412, 462408, 463206</b> Handle for 462412, 462408 and 463206 valves Commande pour valvule 462412, 462408, 463206</p>	145	463260	<b>23,00</b>
	<p><b>Leva de repuesto para grifo monomando sobremesa 463242</b> Spare lever for worktop mixer tap 463242 Lever de rechange pour mitigeur de table 463242</p>	150	463264	<b>19,00</b>
	<p><b>Caño bajo de 200mm. para válvulas</b> 200 mm. low spout for valves 200mm. jet bas pour valves</p>	250	462866	<b>30,00</b>
	<p><b>Caño bajo de repuesto para grifo monoblock 463234</b> Spare low spout for monoblock tap 463234 Bec bas de rechange pour robinet monoblock 463234</p>	270	463262	<b>68,00</b>
	<p><b>Caño para válvula monomando dos aguas</b> Spout for connecting to one handle mounted valve Jet adaptable au robinet monocommande à deux eaux</p>	530	462844	<b>56,00</b>
	<p><b>Caño acoplable a mástil de grifo ducha 250mm.</b> Attachable spout for shower fitting support 250mm. Jet adaptable à tuyau pour robinet douche 250mm.</p>	430	462850	<b>37,00</b>
	<p><b>Caño acoplable a mástil de grifo ducha 200mm.</b> Attachable spout for shower fitting support 200mm. Jet adaptable à tuyau pour robinet douche 200mm.</p>	462849		<b>34,00</b>
	<p><b>Caño acoplable a grifo ducha</b> Spout for shower fitting Bec de robinet adaptable à douchette</p>	1.200	462813	<b>96,00</b>

	<p><b>Caño negro de repuesto para grifo 464632</b> Spare black spout for tap 464632 Bec noir de rechange pour robinet 464632 464636</p>	360	464636	<b>86,00</b>
	<p><b>Caño blanco de repuesto para grifo 464633</b> Spare white spout for tap 464633 Bec blanc de rechange pour robinet 464633</p>	360	464637	<b>86,00</b>
	<p><b>Caño 200 mm. de repuesto para grifo monomando sobremesa 463242</b> Spare 200 mm spout for worktop mixer tap Bec 200 mm. pièce de rechange pour mitigeur sur table 463242</p>	150	463266	<b>50,00</b>
	<p><b>Válvula doble entrada, dos aguas 1/4 vuelta</b> Double inlet valve for deck mounted faucet, 1/4 turn Valve double entrée, 2 eaux 1/4 de tour</p>	1.600	462418	<b>180,00</b>
	<p><b>Válvula doble entrada, dos aguas, monomando codo</b> Double inlet single lever high neck valve, elbow functioning Valve double entrée, 2 eaux, mélangeur à coude</p>	4.000	462420	<b>355,00</b>
	<p><b>Válvula monomando dos aguas</b> Double inlet single lever valve Valve monocommande à deux eaux</p>	2.400	462406	<b>194,00</b>
	<p><b>Pomo corto para válvula 462406</b> Spare flow knob for table shower fitting support Sélecteur de sortie pour robinet douchette</p>	86	462874	<b>16,00</b>
	<p><b>Válvula monomando dos aguas</b> Double inlet single lever valve Valve monocommande à deux eaux</p>	963	462410	<b>121,00</b>
	<p><b>Válvula monomando dos aguas</b> Double inlet single lever tap Valve monocommande à deux eaux</p>	1.800	462412	<b>147,00</b>
	<p><b>Válvula mural monomando dos aguas</b> Wall-mounted single lever valve Valve monocommande de mur à deux eaux</p>	1.750	462408	<b>161,00</b>
	<p><b>Válvula monomando mural de codo monoblock para grifo ducha</b> Single lever wall-mounted monobloc valve, elbow functioning Robinet mono-commande mural à coude monobloc pour robinet douchette</p>	1.600	462422	<b>373,00</b>
	<p><b>Válvula mural dos aguas con levas 1/4 de vuelta</b> Double inlet 1/4 turn wall-mounted valve Valve murale avec pommes 1/4 de tour</p>	1.900	462416	<b>78,00</b>
	<p><b>Válvula dos aguas con levas 1/4 de vuelta</b> Double inlet 1/4 turn valve Valve avec pommes 1/4 de tour</p>	1.500	462414	<b>81,00</b>



	<b>Pomo rojo para válvula 462414 y 462416</b> Red spare flow knob for table shower fitting support Sélecteur rouge de sortie pour robinet douchette	86	462884	<b>19,00</b>
	<b>Pomo azul para válvula 462414 y 462416</b> Blue spare flow knob for table shower fitting support Sélecteur bleu de sortie pour robinet douchette	86	462886	<b>19,00</b>
	<b>Válvula de un agua</b> Single inlet valve Valve à une eau	550	462402	<b>61,00</b>
	<b>Válvula de dos aguas</b> Double inlet valve Valve à deux eaux	1.250	462404	<b>66,00</b>
	<b>Juego válvulas antirretorno para grifo monomando dos aguas</b> Anti-return valves set for double inlet one handle tap Conjoint de valvules anti-retour pour robinet monocommande à deux eaux	85	462846	<b>18,00</b>
	<b>Tuerca de repuesto para caño giratorio 1/2"</b> Spare nut for rotating tap 1/2" Écrou de rechange pour bec pivotant 1/2"	22	462818	<b>5,30</b>
	<b>Adaptador para mástil</b> Shower support adaptor Adaptateur pour support de douche	55	462832	<b>6,00</b>
	<b>Piña para grifo monomando ducha extensible</b> Shower head for one handle extending shower tap Pomme pour robinet monocommande douche extensible	190	463250	<b>51,00</b>
	<b>Latiguillo lastrado para grifo monomando ducha extensible</b> Weighted hose for one handle extending shower tap Flexible lesté pour robinet monocommande douche extensible	437	463252	<b>27,00</b>
	<b>Latiguillo de repuesto para grifo doméstico 463050</b> Spare hose for domestic tap 463050 Tuyau de rechange pour robinet domestique 463050	100	463083	<b>24,00</b>
	<b>Kit de juntas para pulsador temporizado</b> Gasket kit for push button timer Kit de joints pour bouton-poussoir temporisé	5	460450	<b>6,00</b>



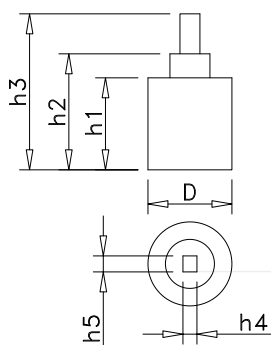

\*Consultar para modelos descatalogados.

\* For discontinued models contact us

\* Consulter pour des modèles hors-catalogue

D	H1	H2	H3	H4	H5	Gr	Barcode	€
---	----	----	----	----	----	----	---------	---

Cartucho para válvula monomando  
Spare cartridge for single lever valve  
Cartouche pour valve monocommande

40 32 42 64 10 10,5 65 462830 **21,00**



463051	463064	463066	463072	463074
463038	463040	463228	463213	465206
463206	463236	463208*	463227	465208
462412	462408	464614	463602	463204*

D	H1	H2	H3	H4	H5	Gr	Barcode	€
---	----	----	----	----	----	----	---------	---

Cartucho para válvula monomando  
Spare cartridge for valve  
Cartouche de rechange pour valve

40 43 54 75 10 10,3 78 463082 **23,00**



463428	463234	463216*	462406*	463050	463062
463214	463228	463218*	463216		

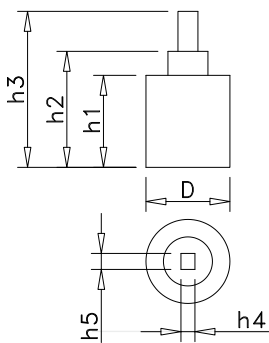

\* Consultar para modelos descatalogados.

\* For discontinued models contact us

\* Consulter pour des modèles hors-catalogue

D H1 H2 H3 H4 H5 Gr €

**Cartucho de repuesto para grifos**

464632 y 464633

Spare cartridge for taps 464632 and 464633

464633

Cartouche de rechange pour robinets

464632 et 464633

39,50 43 51 75 10 10,5 55 464634 **29,00**



464632



464633

D H2 H3 H4 H5 Gr €

**Cartucho para caño o válvula 1/4 de vuelta**

Spare cartridge for spout or 1/4 turn valve

Cartouche pour bec ou valve 1/4 de tour

18,5 37 51,6 7,6 7,6 64 462864 **14,00**



463052



463062



463066



463060



463058



463070



463081



463046



463048

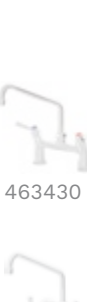

463430

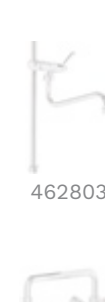

462803



463426



463424



463422



463420

Gr €



**Cartucho para válvula RD**

Spare cartridge for RD valve

Cartouche de rechange pour valve RD

70 462888 **14,00**

## Cartuchos para modelos descatalogados

Cartridges for discontinued models

Cartouches pour des modèles hors-catalogue

D H1 H2 H3 H4 H5   €



**Cartucho para válvula**  
Spare cartridge for valve  
Cartouche de rechange pour valve

42 46 58 78 7 8 90 462828 **49,00**



**Adaptador para cartucho 462828 y leva 462842**  
Adapter for spare cartridge 462828 and handle 462842  
Adaptateur de remplacement pour cartouche 462828 et levier 462842

120 462860 **23,50**

























**Cartucho para válvula**  
Spare cartridge for valve  
Cartouche de rechange pour valve

41 49 61 81 6,4 7 93 463258 **47,00**





		<b>Piña para ducha de gran alcance M 1/2"</b> Shower head for long-reach shower M 1/2" Pomme pour douche à grande portée M 1/2"	85	463020	<b>27,00</b>
		<b>Latiguillo para ducha de gran alcance 2000 mm H-H 1/2"</b> Hose for long-reach shower F-F 1/2" Flexible pour douche a grande portée F-F 1/2"	230	463022	<b>14,00</b>
		<b>Piña para ducha horno M 1/2"</b> Shower head for oven shower M 1/2" Pomme pour douche de four M 1/2"	250	463024	<b>57,00</b>
		<b>Latiguillo para ducha horno 2000 mm H-H 1/2"</b> Hose for oven shower F-F 1/2" Flexible pour douche de four F-F 1/2"	530	462810	<b>27,00</b>
		<b>Piña para ducha horno 463006</b> Shower head for shower oven 463006 Tête de douche pour four à douche 463006	250	463026	<b>90,00</b>
		<b>Latiguillo para ducha horno enrollable 463006 y 463008</b> Roll hose for oven shower 463006 & 463008 Rouler pour douche de four 463006 et 463008 L=1.700 mm.	280	463010	<b>30,00</b>
		<b>Juego de juntas para grifo manguera serie profesional 8 m.</b> Joints set for professional faucet hose 8 m. Conjoint de joints pour robinet-tuyau d'arrosage modèle professionnel 8 m.	30	464068	<b>72,00</b>
		<b>Manguera de repuesto 8 m para grifo de manguera serie profesional</b> Hose complement 8 m. Tuyau d'arrosage de rechange 8 m.	2.500	464064	<b>113,00</b>
		<b>Manguera de repuesto 15 m. para grifo manguera serie inox.</b> Hose complement 15 m. Tuyau d'arrosage de rechange 15 m.	3.000	464066	<b>198,00</b>
		<b>Manguera de repuesto 12 m. para grifo manguera serie profesional</b> Hose complement 12 m. Tuyau d'arrosage de rechange 12 m.	2.500	464074	<b>108,00</b>
		<b>Lanza rociadora M 1/2"</b> Nozzle shower M 1/2" Lance M 1/2"	165	464060	<b>72,00</b>
		<b>Pistola para lanza de acero inoxidable H 1/2"</b> Pistol for stainless steel nozzle F1/2" Pistolet pour lance en acier inoxydable F1/2"	450	464070	<b>61,00</b>



# MOBILIARIO

NEUTRAL FURNITURE  
MEUBLES NEUTRES

## NOVEDADES

NEWS  
NOUVEAUTÉS



294



297



298



299



322



323



324



324



346



350









Detalle de cajón acoplado.  
Fixed drawer coupled.  
Détail de tiroir couplé.



Los modelos con este distintivo pueden fabricarse con altura de 600 mm para cocinas serie snack o modular, sin alterar el precio. Consultar plazo de entrega.  
The models with this badge can be manufactured with height 600 mm for snack or modular stoves without price increasing. Ask delivery time.  
Les modèles avec cet insigne peuvent être fabriqués avec hauteur 600 mm pour snack ou modulaire cuisines sans augmentation de prix. Demandez délai de livraison.

## Características de fabricación de nuestras mesas:

Totalmente fabricadas en acero inoxidable.  
Encimera reforzada e insonorizada de 1,5 mm de espesor.  
Bastidores inferiores de refuerzo bajo encimera en acero inoxidable.  
Bastidor preparado para incorporar entrepaños sin la utilización de herramientas.  
Patas de 40 x 40 mm desplazadas para curva sanitaria, acabado brillante.  
En la fabricación de nuestras mesas no empleamos madera.  
Se adaptan a cualquier desnivel del suelo ya que disponen de pies regulables.  
Opcionalmente se pueden instalar los siguientes accesorios:

Sistema de elevación	298
Cajones y tolvas de café	492
Papelera lateral	394
Portacuchillos	136
Ruedas	496
Fibras de polietileno	75
Contenedores de desperdicios	385
Tolva de desbarasado	465
Fregaderos soldados	317
Esterilizadores de cuchillos	370

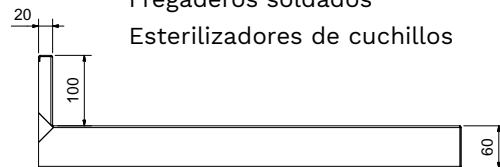

## Manufacturing characteristics of our tables:

Fully made of stainless steel.  
Reinforced and soundproofed worktop 1.5 mm thick.  
Lower supporting structure under stainless steel worktop and ready to install shelves without the use of tools.  
1.5 mm worktop reinforced and acoustically treated  
40x40 mm set back tubular legs to avoid pipes.  
Adjustable feet for a better stability, to have it fitted to any floor unevenness.  
No wood is used in the manufacture of our tables  
Optionally, the following accessories can be installed:

Lifting system	298
Drawers	492
Side wastepaper bin	394
Knifeholder	136
Wheels	496
Polyethylene fibres	75
Waste receptacle for scraps	385
Fixed sinks	465
Containers	317
Knifeholder disinfectant	370



Detalle de rueda de acero inoxidable con freno acoplada a pata.  
Detail of stainless steel wheel with brake assembled to leg.  
Détail de roue en acier inoxydable avec frein installé dans pied.

Detalle de pata con pie regulable con funda antivibradora.  
Detail of adjustable feet with antivibrator cover.  
Détail de pie réglable avec base anti-vibrateur.

## Caractéristiques de fabrication de nos tableaux:

Fabriquée entièrement en acier inoxydable  
Plan de travail renforcé et insonorisé de 1,5 mm d'épaisseur  
Armatures inférieures de renfort sous le plan de travail d'acier inoxydable.  
Armature préparée pour incorporer des étagères sans l'utilisation d'outils.  
Plan renforcé et insonorisé de 1,5 mm d'épaisseur  
Empiètements en tube de 40 x 40 déplacés pour courbure sanitaire  
Empiètements réglables pour favoriser la stabilité, car ils s'adaptent à quelque dénivellement du sol.  
Dans la fabrication de nos tables, nous n'employons pas de bois.  
Optionnellement on peut installer les suivantes accessoires

Système d'élévation	298
Tiroirs et trémie pour marc de café	492
Corbeille à papier lateral	394
Porte couteaux	136
Roues	496
Fibras en polyéthylène	75
Trémie d'évacuation des déchets	385
Eviers soudés	465
Conteneurs	317
Porte-couteaux désinfecteur	370



**Mesas centrales**  
Centre table  
Tables centrales

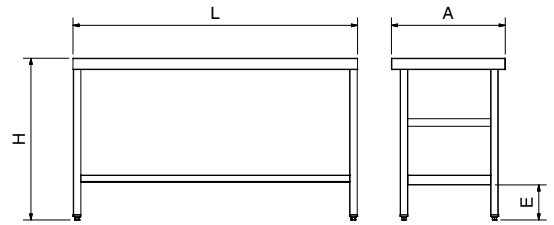

L	A	H	E	Kg	Barcode	€	Kg	Barcode	€	Kg	Barcode	€
1.000	500	850	200	27,0	070202	<b>511,00</b>	23,0	070402	<b>481,00</b>	5,0	2702028	<b>116,00</b>
1.200	500	850	200	26,0	070220	<b>569,00</b>	21,0	070420	<b>535,00</b>	4,0	2702608	<b>125,00</b>
1.500	500	850	200	36,0	070204	<b>625,00</b>	29,0	070404	<b>588,00</b>	9,0	2702048	<b>134,00</b>
2.000	500	850	200	47,0	070206	<b>674,00</b>	36,0	070406	<b>633,00</b>	13,0	2702068	<b>151,00</b>
1.000	600	850	200	29,0	070208	<b>571,00</b>	25,0	070408	<b>537,00</b>	6,0	2702088	<b>134,00</b>
1.200	600	850	200	30,7	070228	<b>604,00</b>	24,9	070428	<b>568,00</b>	6,0	2702688	<b>142,00</b>
1.500	600	850	200	38,0	070210	<b>635,00</b>	32,0	070410	<b>597,00</b>	10,0	2702108	<b>151,00</b>
2.000	600	850	200	52,0	070212	<b>708,00</b>	40,0	070412	<b>665,00</b>	15,0	2702128	<b>169,00</b>
1.000	700	850	200	33,0	070214	<b>622,00</b>	29,0	070414	<b>584,00</b>	8,0	2702148	<b>151,00</b>
1.200	700	850	200	34,8	070236	<b>654,00</b>	27,1	070436	<b>614,00</b>	5,6	2702768	<b>160,00</b>
1.500	700	850	200	43,0	070216	<b>686,00</b>	34,0	070416	<b>645,00</b>	13,0	2702168	<b>169,00</b>
2.000	700	850	200	60,0	070218	<b>776,00</b>	46,0	070418	<b>730,00</b>	19,0	2702188	<b>186,00</b>

**Mesas murales**  
Wall tables  
Tables murales

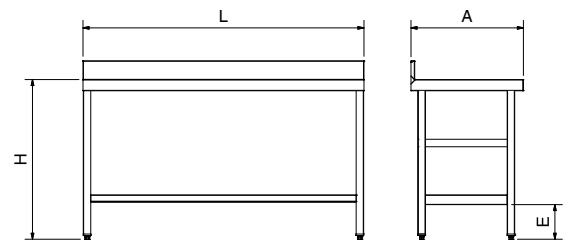

L	A	H	E	Kg	Barcode	€	Kg	Barcode	€	Kg	Barcode	€
1.000	500	850	200	24,0	070602	<b>541,00</b>	21,0	070802	<b>498,00</b>	5,0	2702028	<b>116,00</b>
1.200	500	850	200	26,7	070620	<b>589,00</b>	21,7	070820	<b>554,00</b>	4,0	2702608	<b>125,00</b>
1.500	500	850	200	35,0	070604	<b>628,00</b>	29,0	070804	<b>610,00</b>	9,0	2702048	<b>134,00</b>
2.000	500	850	200	47,0	070606	<b>677,00</b>	37,0	070806	<b>656,00</b>	13,0	2702068	<b>151,00</b>
1.000	600	850	200	27,0	070608	<b>592,00</b>	23,0	070808	<b>557,00</b>	6,0	2702088	<b>134,00</b>
1.200	600	850	200	31,3	070628	<b>626,00</b>	25,5	070828	<b>588,00</b>	4,8	2702688	<b>142,00</b>
1.500	600	850	200	38,0	070610	<b>658,00</b>	32,0	070810	<b>619,00</b>	10,0	2702108	<b>151,00</b>
2.000	600	850	200	52,0	070612	<b>735,00</b>	40,0	070812	<b>691,00</b>	15,0	2702128	<b>169,00</b>
1.000	700	850	200	31,0	070614	<b>645,00</b>	26,0	070814	<b>606,00</b>	8,0	2702148	<b>151,00</b>
1.200	700	850	200	35,4	070636	<b>679,00</b>	27,8	070836	<b>637,00</b>	5,6	2702768	<b>160,00</b>
1.500	700	850	200	45,0	070616	<b>713,00</b>	37,0	070816	<b>670,00</b>	13,0	2702168	<b>169,00</b>
2.000	700	850	200	61,0	070618	<b>804,00</b>	46,0	070818	<b>757,00</b>	19,0	2702188	<b>186,00</b>

## Mesas murales con puertas

Wall tables with doors  
Tables murales avec portes



### Características:

Fabricada íntegramente en acero inoxidable, laterales y trasera cerrados en acero inoxidable. Entrepaña inferior a 200 mm del suelo y el otro centrado. La principal ventaja de nuestras mesas de puertas correderas consiste en que las puertas van colgadas, lo que evita depósitos de suciedad en carriles y entrepaños. Tiradores integrados en la puerta.

### Characteristics:

Fully made of stainless steel, sides and back covered with stainless steel panels. Centered shelf.

The main advantage of our sliding doors tables consists on their hanging doors. They avoid dirtiness deposits in rails and shelves. Furthermore the handles are integrated in the door.

### Caractéristiques:

Entièrement fabriquée en acier inoxydable, latérales et fond recouvertes en acier inoxydable. Tablette-rayon centré.

La principale avantage de nos tables à portes coulissantes c'est que ses portes sont suspendues pour éviter des dépôts de saleté dans les rails et dans les tablettes-rayons. En plus les poignées sont intégrées dans la porte.

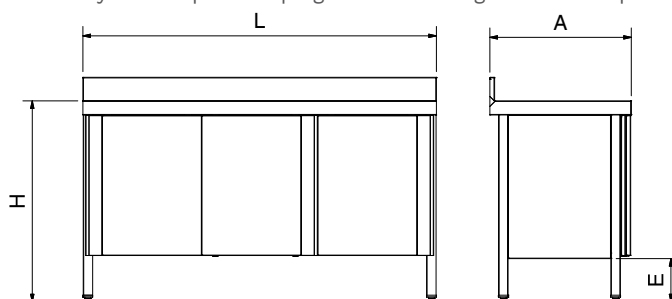
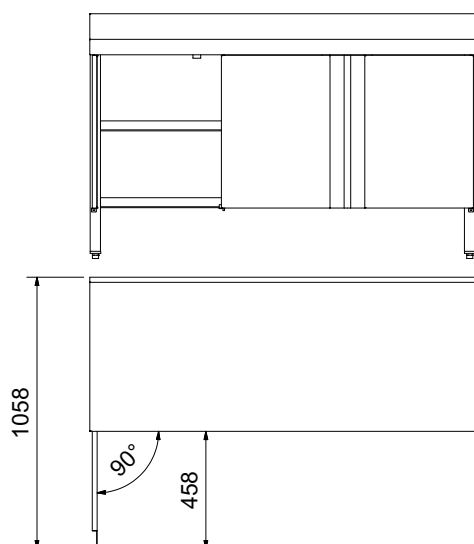

Correderas  
Sliding doors  
Coulissantes

Abatibles  
Hinged doors  
Deux battants

L	A	H	E	Kg	Barcode	Q	€	Kg	Barcode	Q	€
1.000	400	850	200	28,0	073803	2	<b>1.035,00</b>				
1.000	500	850	200	40,0	073802	2	<b>1.006,00</b>	42	074002	2	<b>1.026,00</b>
1.500	500	850	200	56,0	073804	3	<b>1.245,00</b>	59	074004	3	<b>1.270,00</b>
2.000	500	850	200	67,0	073806	4	<b>1.468,00</b>	71	074006	4	<b>1.498,00</b>
1.000	600	850	200	43,0	073808	2	<b>1.197,00</b>	45	074008	2	<b>1.222,00</b>
1.500	600	850	200	58,0	073810	3	<b>1.417,00</b>	61	074010	3	<b>1.446,00</b>
2.000	600	850	200	77,0	073812	4	<b>1.637,00</b>	81	074012	4	<b>1.670,00</b>
1.000	700	850	200	48,0	073814	2	<b>1.292,00</b>	50	074014	2	<b>1.320,00</b>
1.500	700	850	200	64,0	073816	3	<b>1.522,00</b>	67	074016	3	<b>1.554,00</b>
2.000	700	850	200	84,0	073818	4	<b>1.749,00</b>	88	074018	4	<b>1.784,00</b>

## Mesas murales a pared

Wall-fitted tables  
Tables à fixer au mur

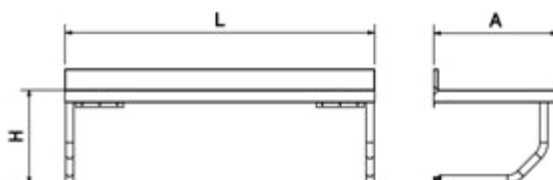

L	A	H	Kg	Barcode	€
1.000	500	450	17	071002	<b>570,00</b>
1.500	500	450	22	071004	<b>696,00</b>
1.000	600	450	23	071006	<b>604,00</b>
1.500	600	450	28	071008	<b>751,00</b>
1.000	700	450	26	071010	<b>679,00</b>
1.500	700	450	34	071012	<b>823,00</b>

## Mesas murales con puertas y cajones

Wall tables with with doors and drawers  
Tables murales avec portes et tiroirs



### Characteristics:

Fully manufactured in stainless steel (both internal and external).  
Reinforced and soundproofed worktop in 1.5 mm. thickness  
Two or three suspended sliding doors, without bottom rails to avoid deposits of dirt.  
Side panels.  
Double shelf. Closet area with rear and interior sides paneled.  
Four drawers with lock. Interior dimensions of the drawers: 460x440x140 mm.  
Retracted hind legs to adapt to the sanitary curves of the floor with wall.  
Adjustable feet to meet the food standards.

### Caractéristiques:

Entièrement fabriquée (intérieurement et extérieurement) en acier inoxydable.  
Plan de travail de 1,5 mm d'épaisseur, renforcé et insonorisé.  
Deux ou trois portes coulissantes suspendues, sans rails inférieurs où la saleté peut être déposée.  
Côtés doublés.  
Double étagère, côté arrière et intérieur dans la zone de l'armoire.  
Quatre tiroirs avec serrure. Dimensions intérieures des tiroirs: 460x440x140 mm.  
Pattes arrière rétractées pour s'adapter aux courbes sanitaires du sol avec mur.  
Pieds réglables norme alimentaire.

### Características:

Fabricada totalmente (interior y exterior) en acero inoxidable.  
Encimera de 1,5 mm de espesor, reforzada e insonorizada.  
Dos o tres puertas de corredera suspendidas, sin carriles inferiores donde se pueda depositar la suciedad.  
Laterales forrados.  
Doble entrepaño, trasera y lateral interior en la zona del armario.  
Cuatro cajones con cerradura. Dimensiones interiores de los cajones: 460x440x140 mm  
Patatas traseras retranqueadas para adaptarse a las curvas sanitarias del suelo con pared.  
Pies regulables norma alimentaria.

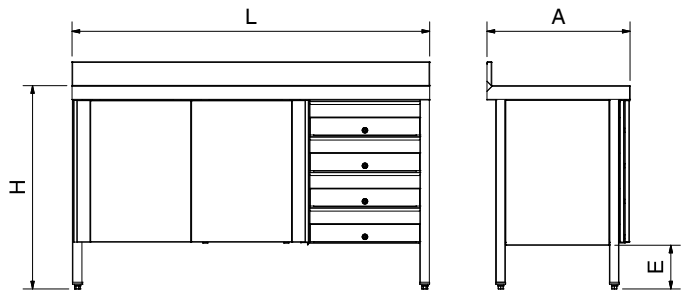

L	A	H	E		Kg		€
1.500	500	850	180	2	71	074474	<b>2.020,00</b>
1.500	600	850	180	2	73	074452	<b>2.078,00</b>
1.500	700	850	180	2	79	074456	<b>2.504,00</b>
2.000	500	850	180	3	82	074476	<b>2.234,00</b>
2.000	600	850	180	3	92	074454	<b>2.361,00</b>
2.000	700	850	180	3	99	074458	<b>2.761,00</b>

## Mesa mural con cartelas

Wall fitted table with brackets  
Table murale avec équerres

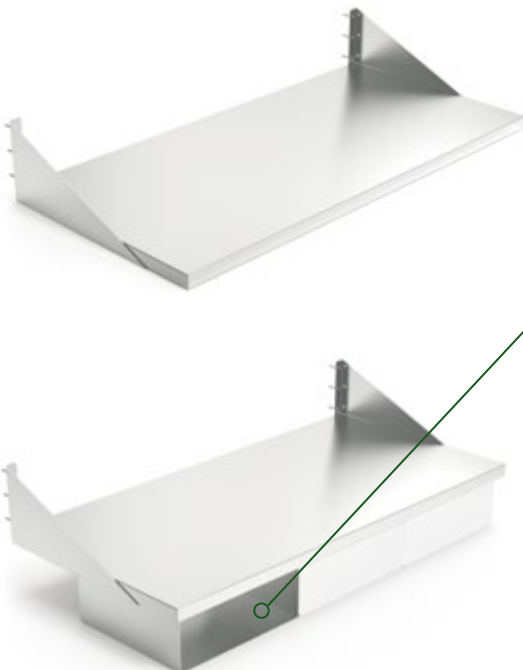

085426 € 68,00

Cajonera para mesa mural con cartelas (400 mm.)  
Drawer box for wall-fitted table with brackets  
Tiroirs pour table murale avec équerres

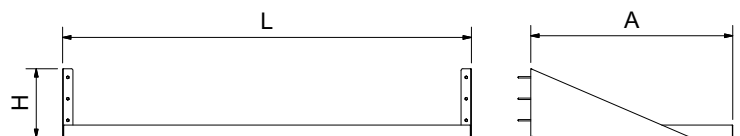

L	A	H	Kg		€
800	600	200	6	071050	<b>138,00</b>
1.000	600	200	7	071052	<b>141,00</b>
1.200	600	200	8	071054	<b>151,00</b>
1.400	600	200	9	071056	<b>154,00</b>

## Mesas murales de Chef

Chef wall table  
Table murale de chef

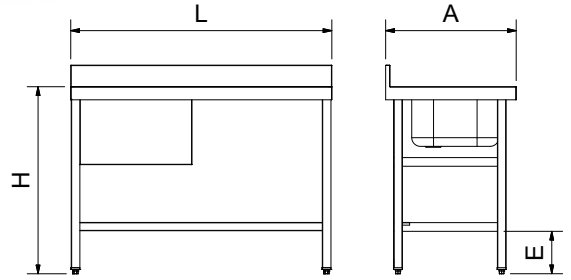
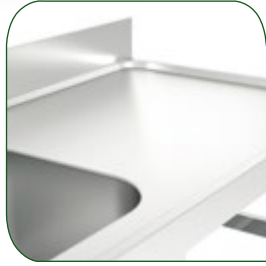
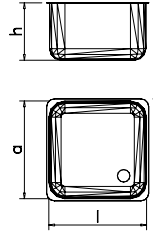

Válido para lavaplatos.  
Valid for dish washers.  
Valide pour machines à  
laver assiettes.

	Con entreaño With shelf Avec tablette-rayon								Sin entreaño Without shelf Sans tablette-rayon					
	L	A	H	E	I	a	h	Kg	€		Kg	€		
	1.200	600	850	200	500	400	250	27	075202	<b>785,00</b>		24	075402	<b>690,00</b>
	1.200	700	850	200	500	500	300	29	075206	<b>820,00</b>		26	075406	<b>725,00</b>
	1.200	600	850	200	500	400	250	27	075204	<b>785,00</b>		24	075404	<b>690,00</b>
	1.200	700	850	200	500	500	300	29	075208	<b>820,00</b>		26	075408	<b>725,00</b>

## Mesa mural desbarasado con fregadero

Wall table for waste chutes with sink  
Table murale vide déchets avec bac

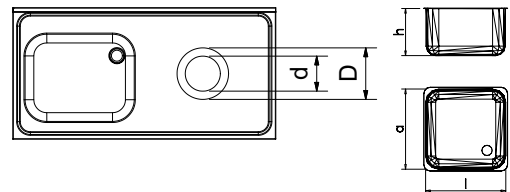
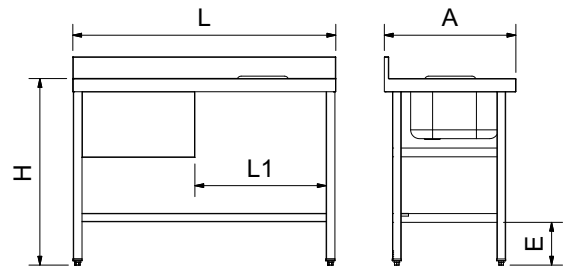

	L	A	H	E	I	a	h	L1	D	d	Kg	€	
	1.200	600	850	195	500	400	250	600	235	160	24,5	980300102	<b>769,00</b>
	1.200	700	850	195	500	500	300	600	235	160	26,5	980300104	<b>804,00</b>
	1.200	600	850	195	500	400	250	600	235	160	24,5	980300202	<b>769,00</b>
	1.200	700	850	195	500	500	300	600	235	160	26,5	980300204	<b>804,00</b>

## Mesa mural desbarasado con puerta

Waste chutes wall table  
Table murale pour trémie à déchets



### Características:

Laterales forrados en acero inoxidable.  
Aro para tolva de desbarasado color azul.  
Tapa para aro.

### Characteristics:

Sides covered with stainless steel panels.  
Blue ring for waste chutes.  
Ring lid.

### Caractéristiques:

Latérales recouvertes en acier inoxydable.  
Cercle bleu pour trémies à déchets.  
Couvercle.

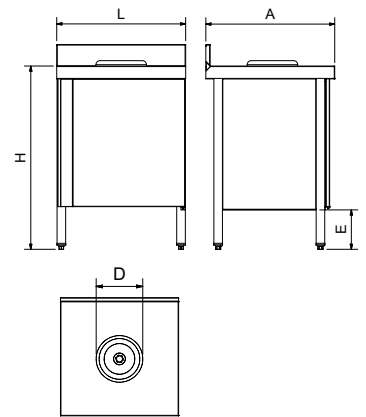

Ejemplo de zona de lavado. Posibilidad de diferentes combinaciones al poder colocar la mesa a uno u otro lado.  
Example of rinse zone. Possibility of different combinations with the table on one side or the other.  
Exemple de zone de lavage. Possibilité de diverses combinaisons avec la table d'un côté ou de l'autre.

L	A	H	D	E	Kg	Barcode	€
600	600	850	235	200	23	074438	<b>601,00</b>
600	700	850	235	200	28	074437	<b>800,00</b>

## Mesa de preparación de verduras

Vegetable preparation table  
Table de préparation de légumes

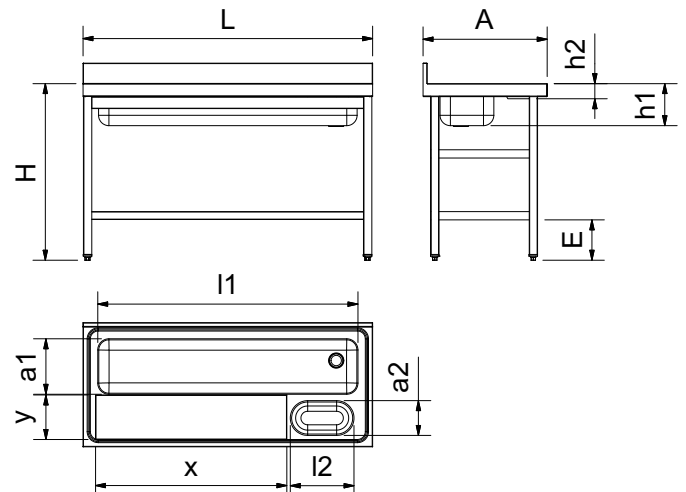

L	A	H	E	I1	a1	h1	I2	a2	h2	X	y	Kg	Barcode	€
1.400	600	850	200	1.250	260	180	300	160	50	925	215	28	075602	<b>950,00</b>

## Mesas de preparación y lavado

Preparation and cleansing tables  
Tables de préparation et de lavage



**Dotación y características de fabricación:**  
Totalmente construida con acero inoxidable.  
Fibra de polietileno calidad P-500.  
Fregadero soldado con válvula, tapón y rebosadero.  
Tolva de evacuación de desperdicios.

**Features and manufacturing characteristics:**  
Fully made of stainless steel.  
P-500 quality polyethylene cutting board.  
Welded bowl with valve, plug and overflow.  
Hole for waste-chutes

**Dotation et caractéristiques de fabrication:**  
Entièrement fabriquées en acier inoxydable.  
Plaque découpe de polyéthylène qualité P-500.  
Bac soudée avec valve, déversoir.  
Trou pour tremie à déchets.



**Repuestos de fibras.**  
Spare cutting boards.  
Plaques de découpe.



78

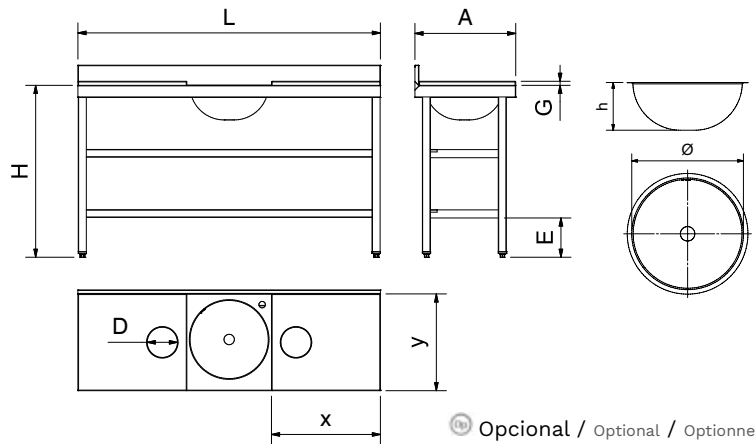

Optional / Optional / Optionnel

	L	A	H	E	Ø	h	X	y	G	D	Kg	€
	1.000	500	850	200	390	170	540	480	20	150	23,5	072802 072880 <b>839,00</b> 072852
	1.000	500	850	200	390	170	540	480	20	150	23,5	072810 072882 <b>839,00</b> 072860
	1.500	500	850	200	390	170	540	480	20	150	30,0	072812 072884 <b>1.036,00</b> 072862
	1.500	500	850	200	390	170	540	480	20	150	30,0	072820 072886 <b>1.036,00</b> 072870
	1.500	500	850	200	390	170	540	480	20	150	34,0	072822 072888 <b>1.176,00</b> 072872

**Mesa mural de prelavado**  
Pre-rinse wall table  
Table mural de pré-lavage



**Dotación y características de fabricación:**  
Totalmente construida en acero inoxidable, provista de reborde perimetral salva-aguas. Esta mesa está diseñada para albergar un lavavajillas y un contenedor de residuos debajo. Además hay espacio útil para depositar las cestas en la encimera antes del desbarasado.  
Dotada de fregadero soldado con válvula, tapón, rebosadero y tolva de evacuación de desperdicios.  
Incorpora tacos regulables en altura.

**Equipment and manufacturing characteristics:**

Fully made of stainless steel. Constructed with perimeter raised edge to avoid spilling water. Designed to lodge a dishwasher and a waste bin underneath. Additionally, there is room enough to place the baskets on the worktop before scrapping the wastes.

**Équipement et caractéristiques de fabrication:**

Dessus construit en acier inoxydable. Fabriquée avec rebord dans le périmètre pour éviter des reversement d'eau. Cette table a été dessinée pour allouer un lave-vaisselles et un conteneur de déchets dessous. En plus, il y a espace libre pour déposer des paniers dans le dessus avant l'évacuation des déchets.  
Pourvu avec plonge soudé avec valve, bouchon et déversoir et trémie d'évacuation de déchets. Il inclut des vérins réglables en hauteur.

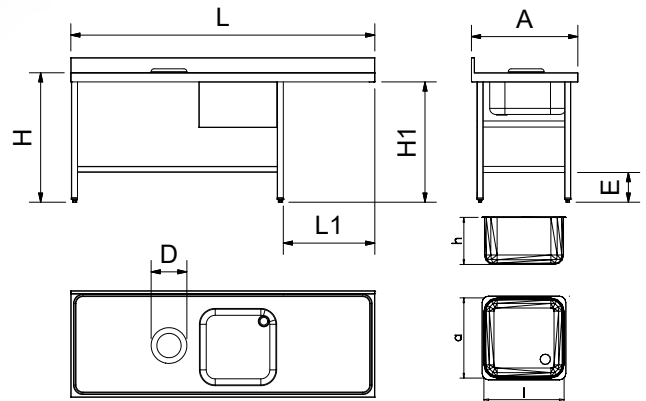

L A H l a h L1 H1 D E Kg €

	2.000	700	930	500	500	300	605	870	235	200	40	074435	<b>1.244,00</b>
	2.000	700	930	500	500	300	605	870	235	200	40	074436	<b>1.244,00</b>

Incluido / Included / Inclus  
 Opcional / Optional / Optionnel

## Mesas de entrada / salida de lavavajillas

Inlet / outlet tables for dishwasher

Tables d'entrée/sortie pour lave-vaisselle



Fabricadas en acero inoxidable, estas mesas de entrada y salida para lavavajillas son regulables en altura y aptas para su ubicación tanto a izquierda como a derecha del lavavajillas.

Las cestas de lavavajillas de 500x500 mm encajan a la perfección en la parte superior del fregadero, facilitando la tarea del pre-lavado.

Incorporan entrepaño inferior de gran utilidad para el almacenaje de cestas vacías o llenas, despejando así la parte superior.

Combine esta mesa de entrada para lavavajillas con cualquiera de nuestros grifos ducha para obtener un máximo rendimiento.

Made of stainless steel, these inlet/outlet tables for dishwashers are height adjustable, and suitable both for the left or right hand of the dishwasher.

The 500x500 mm dishwasher racks fit seamlessly on the upper side of the sink for an easy pre-rinse operation

It is provided with a lower shelf, very helpful for the full or empty racks storage, to get a clear surface on the upper side.

Combine this inlet table for dishwashers with any of our shower taps to obtain the best performance.

Fabriquées en acier inoxydable, ces tables d'entrée et de sortie pour lave-vaisselle sont réglables en hauteur et peuvent être placées aussi bien à gauche qu'à droite du lave-vaisselle.

Les paniers lave-vaisselle de 500x500 mm s'adaptent parfaitement au dessus de l'évier, ce qui facilite le pré-lavage.

Ils intègrent une étagère inférieure très utile pour ranger les paniers vides ou pleins, dégageant ainsi la partie supérieure.

Combinez cette table d'entrée allant au lave-vaisselle avec n'importe lequel de nos robinets de douche pour une performance maximale.

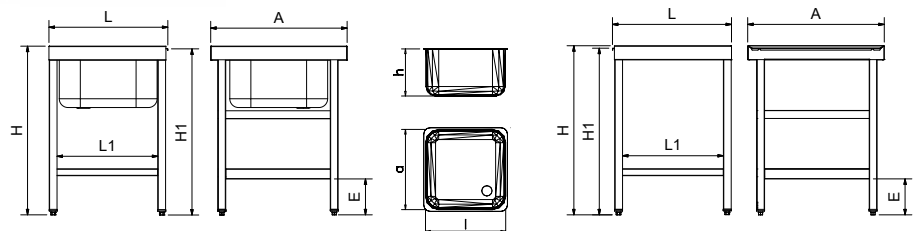

	L	A	H	L1	H1	E	I	a	h	Kg	Barcode	€
Light Grey	610	700	865	515	855	200	500	500	300	23,00	077202	756,00
Dark Grey	610	700	865	515	855	200				19,90	077250	426,00



## Mesas murales de cajones

Wall-side tables with drawers  
Tables murales à tiroirs



### Características:

Provistas de cajones con rodamientos totalmente contruidos en acero inoxidable. Laterales forrados en zona de cajones. Cajones a mano derecha o izquierda a elección del cliente.

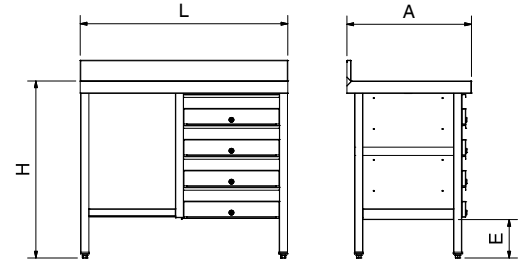

Characteristics:  
Supplied with drawers, with all bearings made of stainless steel. Both sides panelled in the drawers zone. Drawers either on the right or on the left, at the customer's choice.

Caractéristiques:  
Munies de tiroirs avec roulements entièrement fabriqués en acier inoxydable. Côtés recouverts au niveau des tiroirs. Tiroirs à droite ou à gauche au choix du client.

L	A	H	E	Kg	Barcode	€
1.000	500	850	200	44	074202	<b>1.429,00</b>
1.000	600	850	200	48	074204	<b>1.477,00</b>
1.000	700	850	200	54	074206	<b>1.535,00</b>

## Mesa-bastidor para horno

Oven table-support  
Table pour four

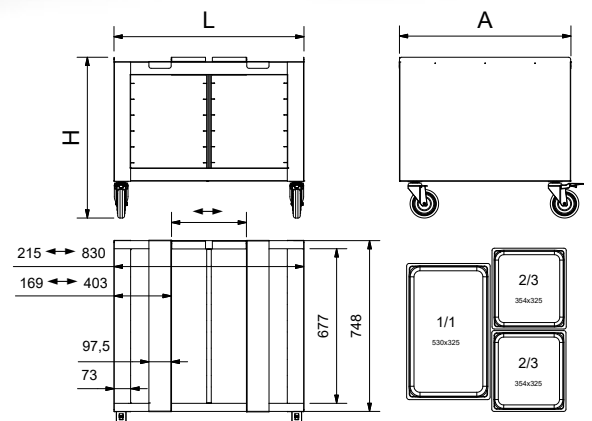

L	A	H	Kg	Barcode	€
832	750	700	30,70	074804	<b>941,00</b>

## Mesas plegables con entrepaño

Centre table with shelf  
Table centrale avec rayon

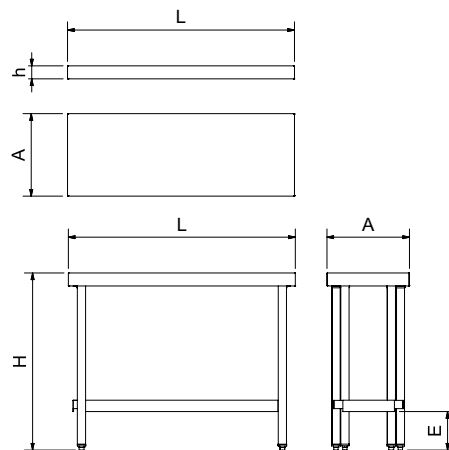

L	A	H	E	h	Kg	Barcode	€
1.100	400	860	187	63	16,0	075804	<b>485,00</b>
1.300	400	860	187	63	18,0	075806	<b>505,00</b>
1.100	500	860	187	63	17,0	075808	<b>517,00</b>
1.300	500	860	187	63	19,0	075810	<b>538,00</b>

## Mesa mural sotabanco con dos entrepaños

Console table with two shelves  
Table console avec deux tablettes-rayons

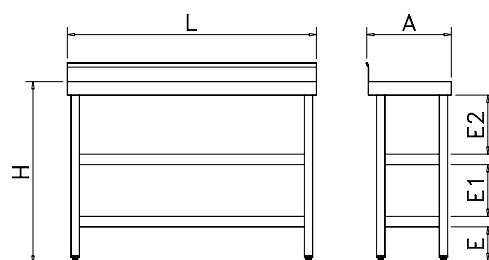

L	A	H	E	E1	E2	Kg	Barcode	€
1.000	400	850	200	243	243	15,95	074408	<b>452,00</b>
1.200	400	850	200	243	243	19,95	074410	<b>477,00</b>

## Mesa central con dos entrepaños. Especial cortadoras de fiambre

Centre table with two shelves. Specially for cutting machines  
Table centrale avec deux rayons. Special pour machines à couper

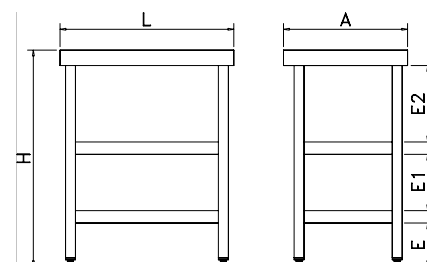

L	A	H	E	E1	E2	Kg	Barcode	€
705	505	855	150	270	270	18	074402	<b>426,00</b>

## Mesa central con dos entrepaños. Especial cortadoras de fiambre

Centre table with two shelves. Specially for cutting machines

Table centrale avec deux rayons. Spécial pour machines à couper

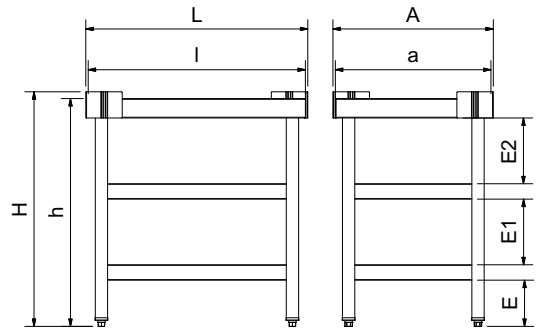

L	l	A	a	H	h	E	E1	E2	Kg	Barcode	€
720	705	520	505	762	740	150	213	213	13,80	074426	<b>456,00</b>

## Mesa central con ruedas y 2 entrepaños

Centre table with wheels and 2 shelves

Table centrale avec roulettes et 2 tablettes dessous

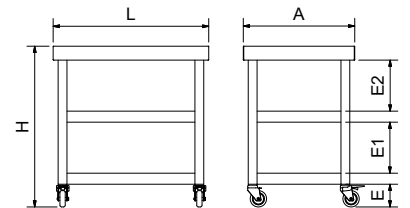

L	A	H	E	E1	E2	Kg	Barcode	€
705	505	730	100	230	230	23,00	074418	<b>519,00</b>

## Soporte sobre-mostrador para cortadoras de fiambre

Stand support for cutting machine

Support sur comptoir pour coupe-charcuterie



### Características:

Altura regulable.

Las guías inferiores son regulables para la adaptación al ancho de la tapa del evaporador de cualquier vitrina.

### Characteristics:

Adjustable height.

The lower rails are adjustable to adapt the width of the evaporator cover of any display.

### Caractéristiques:

Hauteur réglable.

Les rails inférieurs sont réglables pour l'adaptation du largeur du couvercle de l'évaporateur à quelque comptoir.

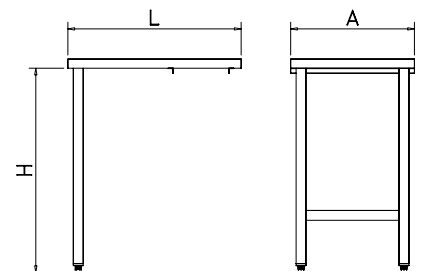

L	A	H	Kg	Barcode	€
690	490	802-882	8,15	082204	<b>272,00</b>

### Mesa central con entrepaño. Especial maquinaria

Centre table with shelf. Specially for machines  
Table centrale avec rayon. Spécial pour machinerie

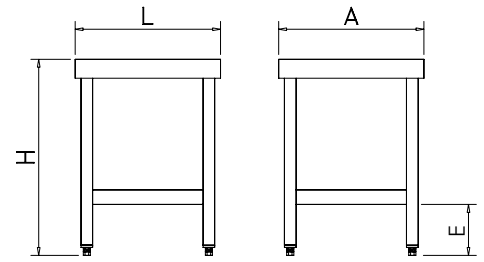

L	A	H	E	Kg	Barcode	€
505	505	655	150	15	074422	<b>304,00</b>

### Mesa central con entrepaño especial maquinaria - Altura estándar

Center table with shelf, special for machinery - Standard height  
Table centrale spéciale machine , avec étagère dessous- Hauteur standard



**N**ovedad  
New  
Nouveauté

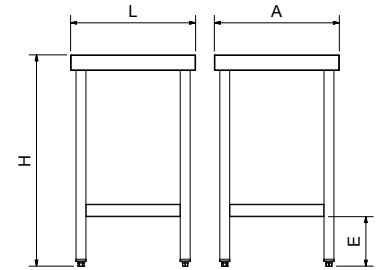

L	A	H	E	Kg	Barcode	€
505	505	853	200	8,15	074420	<b>319,00</b>

### Mesa para maquinaria con sistema de elevación

Table for machinery with lifting system  
Table spéciale machines avec système d'élévation



#### Características:

Con esta utilidad, su personal, independientemente de su altura, podrá adaptar el centro de trabajo a las necesidades particulares, realizando su jornada diaria mucho más cómoda y segura, evitará malas posturas y en gran medida, posibles accidentes o lesiones.

#### Characteristics:

With this utility, your staff, regardless of their height, can adapt the workplace to particular needs, making their daily work much more comfortable and safer, avoid bad postures and to a large extent, possible accidents or injuries.

#### Caractéristiques:

Avec cet exemplaire, votre personnel, quelle que soit sa taille, peut adapter le lieu de travail à ces besoins particuliers, réalisant son travail quotidien de forme plus confortable et sûre, évitant les mauvaises positions et en outre mesure les possibles accidents ou blessures.

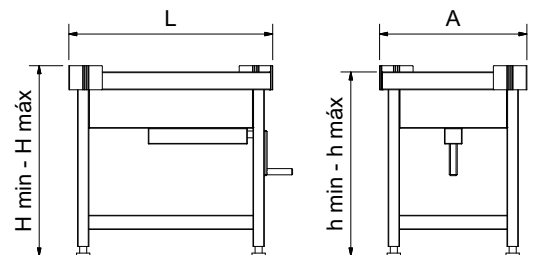
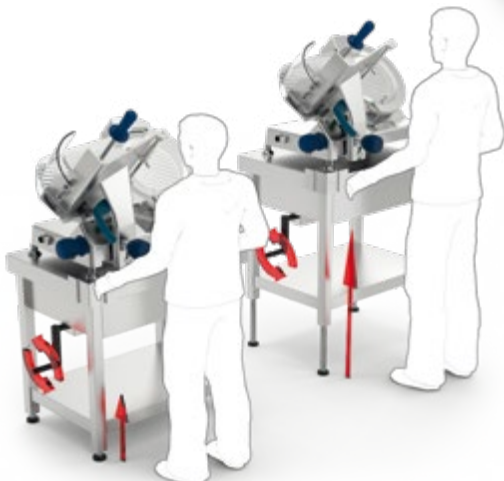

L	A	H min - H max	h min - h max	Kg	Barcode	€
721	521	672 - 872	650 - 850	20,00	074470	<b>1.521,00</b>

## Mesa mural inox con sistema de elevación

Stainless steel wall table with lifting system  
Table inox adossée avec système d'élevation



### Características:

Con esta utilidad, su personal, independientemente de su altura, podrá adaptar el centro de trabajo a las necesidades particulares, realizando su jornada diaria mucho más cómoda y segura, evitará malas posturas y en gran medida, posibles accidentes o lesiones.

### Characteristics:

With this utility, your staff, regardless of their height, can adapt the workplace to particular needs, making their daily work much more comfortable and safer, avoid bad postures and to a large extent, possible accidents or injuries.

### Caractéristiques:

Avec cet exemplaire, votre personnel, quelle que soit sa taille, peut adapter le lieu de travail à ces besoins particuliers, réalisant son travail quotidien de forme plus confortable et sûre, évitant les mauvaises positions et en outre mesure les possibles accidents ou blessures.

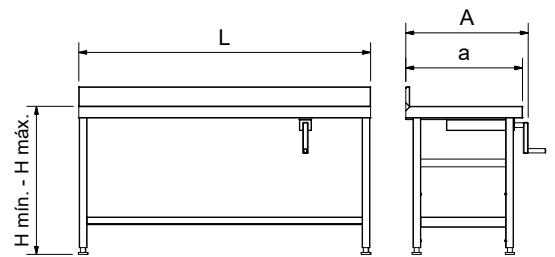

L	A	a	H <sub>min</sub>	H <sub>max</sub>	Kg	Barcode	€
1500	630	600	760	960	40,00	070662	1.673,00

## Mesa mural con puertas y sistema de elevación eléctrico

Wall-side table with doors and electric lifting system  
Table murale avec portes et système de levage électrique

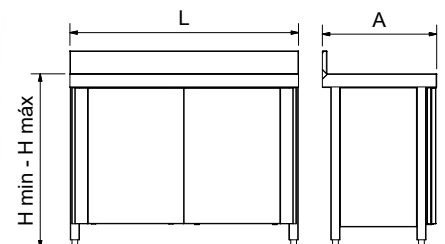

L	A	H <sub>min</sub>	H <sub>max</sub>	Kg	Barcode	€
1000	500	760	960	50,00	073860	2.150,00

## Mesa de terraza

Terrace working table  
Table Terrasse



Diseñada para su uso en terrazas y exteriores, esta mesa será de gran utilidad.  
Fabricada en acero inoxidable AISI 304, incorpora dos cajones sencillos y uno doble, todos ellos con cerradura.  
Cuenta con una puerta abatible.  
Dispone de cuatro ruedas giratorias de estructura galvanizada y banda de rodadura de goma anti-sonora, dos de ellas con freno.

Opcionalmente se le pueden instalar:  
Estanterías de sobremesa.  
Portanotas mural.  
Adaptador de cestillos cuberteros.  
Adaptador de contenedor desperdicios.  
Adaptador de cubetas gastronorm.  
Kit de utensilios, válido también para manteles de papel.  
Tolva para evacuación de desperdicios en el lateral de la zona de la puerta.

081802 25,00 462

Porta-notas mural  
Wall mounted note-holder  
Porte-notes mural

486024 24,00 389

Contenedor de desperdicios y reciclaje  
Waste and recycling container  
Conteneur à ordures et recyclage

076060 316,00 313  
276060

Estanterías de sobremesa  
Desktop shelves  
Étagères à poser sur table

020102 37,00 49

Kit para colgar utensilios  
Tool-holder kit  
Kit pour suspendre outils



Specially designed for outdoor and terrace use. This table will be very useful.

Made of stainless steel AISI 304. It is provided with two single drawers and a double one, all of them with lock.

Cabinet with hinged door.

It has four rotating wheels, two of them with brake, with structure in galvanized steel and anti-noise rolling profile in rubber.

Optionally, the following accessories can be installed:

Tabletop shelves.

Wall-mounted tab grabber.

Adaptor for cutlery basket.

Adaptor for waste container.

Adaptor for Gastronorm container.

Tool-holder kit, also suitable for disposable tablecloths.

Waste receptacle for scraps, on the side of the cabinet.

Conçue pour un usage en terrasse et en extérieur, cette table vous sera d'une grande utilité.

Fabriquée en acier inoxydable AISI 304, avec deux tiroirs simples et un double, tous avec serrure.

Disposé d'une porte rabattable.

Dispose de quatre roulettes tournantes de structure galvanisée et bande de roulement anti-sonore, deux d'elles avec frein.

Optionnellement on peut lui installer:

Des étagères à poser.

Porte-notes mural.

Adaptateur de panier à couverts.

Adaptateur de container de déchets.

Adaptateur de bac gastronorm.

Kit d'ustensiles, valide aussi pour des nappes en papier.

Trémie d'évacuation des déchets sur le côté dans la zone de la porte.

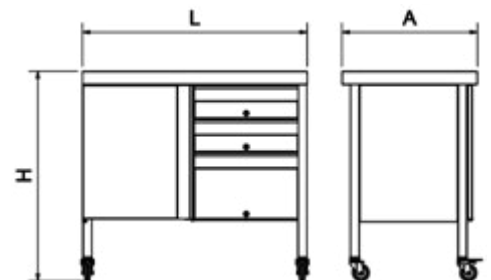

L	A	H	E	Kg	Barcode	€
1.000	600	930	270	55,0	075240	1.514,00

# Mesa barman

Barman table  
Barman tableau



### Dotación de serie:

- 4 Cubetas GN 1/9 de 100 mm
- 3 Cubetas GN 1/2 de 200 mm
- 1 Fibra negra de 300x200x20 mm
- 1 Agujero evacuación de desperdicios.
- 1 Grifo monomando extensible cod. 463206
- 1 Cubeta fregadero Ø260x115 mm
- 1 Entrepaña.
- 4 Tacos regulables rosca sanitaria.

### Equipment included:

- 4 Containers GN 1/9 100 mm
- 3 Containers GN 1/2 200 mm
- 1 Black cutting board 300x200x20 mm.
- 1 Waste chutes hole.
- 1 One handle elbow functioning tap, extending shower. Code 463206
- 1 Sink Ø 260x115 mm
- 1 Shelf
- 4 Plastic adjustable feet with thread inside.

### Équipement inclus:

- 4 Bacs GN 1/9 100 mm
- 3 Bacs GN 1/2 200 mm
- 1 Plaque de découpe noire 300x200x20 mm.
- 1 Trou à déchets.
- 1 Robinet monocommande à coude, douche extensible.Cod 463206
- 1 Evier Ø 260x115 mm
- 1 Tablette-rayon.
- 4 Taquets réglables avec filet intérieur.



083060

€ 70,00



462

Botellero  
Wine rack  
Porte-bouteilles

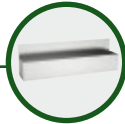

461430 15,00



201

Bidón de 10 lts  
10 litres water drum  
Bidon d'eau de 10 litres



486024 24,00



389

Contenedor de desperdicios  
y reciclaje  
Waste and recycling container  
Conteneur à ordures et  
recyclage



496

Ruedas  
Wheels  
Rouelles

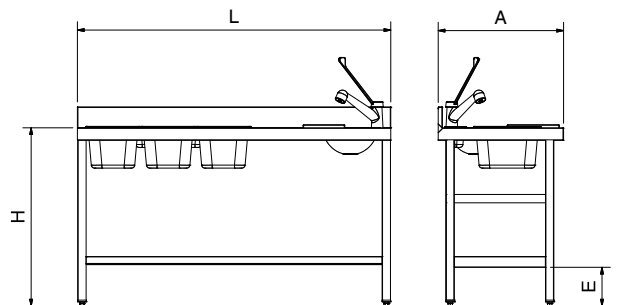
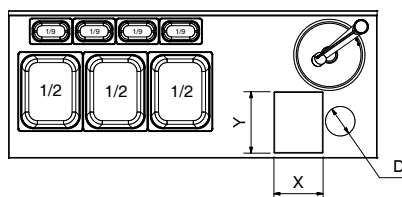
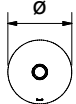
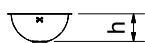

Incluido / Included / Inclus  
 Opcional / Optional / Optionnel

L	A	H	E	D	X	Y	h	Ø	Kg		€
1.500	600	850	200	120	200	300	115	260	48,0	075250	1.200,00

## Mueble cafetero inox basic

Stainless steel cabinet for coffee machine, basic line  
Meuble pour cafetière en acier inoxydable simple



Mueble especial para cafeteras, fabricado completamente en acero inoxidable.

Incorpora un cajón preparado para los posos de café. En la parte inferior incluye un armario de puerta abatible, así como un módulo contiguo de 3 entrepaños para almacenaje. La encimera está provista de un agujero para realizar la instalación de la cafetera.



Specially for coffee machines. Made entirely of stainless steel.

Provided with a drawer for coffee grounds. In its lower part includes a hinged door and an adjoining set of 3 shelves.

The worktop has a hole for the installation of the coffee machine.

Meuble spécial pour cafetière, fabriqué entièrement en acier inoxydable.

Il intègre un tiroir préparé pour le marc de café. Dans la partie inférieure intègre un meuble à portes pliantes, ainsi qu'un module contigu de 3 tablettes pour le stockage. Dotée d'un trou pour l'installation de la machine à café.

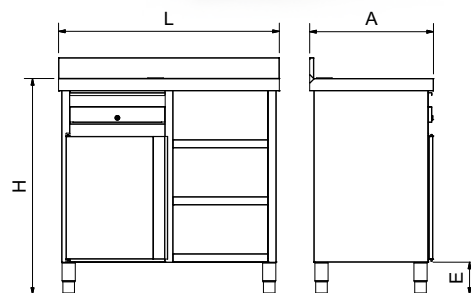
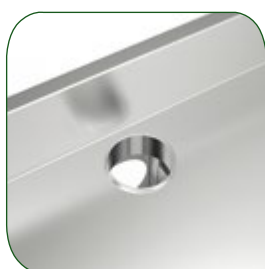

L	A	H	E	Kg	Barcode	€
1.070	600	1.040	150	48,42	074602	956,00

## Mueble cafetero inox doble

Stainless steel cabinet for coffee machine, twin line  
Meuble inox pour cafetière double



Mueble especial para cafeteras, fabricado completamente en acero inoxidable.

Incorpora un cajón preparado para los posos de café. En la parte inferior incluye un armario de puerta abatible. A cada lado del armario se incluyen módulos de 3 entrepaños para aumentar el espacio de almacenaje. La encimera está provista de un agujero para realizar la instalación de la cafetera.



Specially for coffee machines. Made entirely of stainless steel.

Provided with a drawer for coffee grounds. In its lower part includes a hinged door and one set of 3 shelves at every side, for an increased storage capacity. The worktop has a hole for the installation of the coffee machine.

Meuble spécial pour cafetière, fabriqué entièrement en acier inoxydable.

Dans le module central intègre un tiroir préparé pour le marc de café. Dans la partie inférieure inclus une armoire à porte battante. Sur chaque côté, inclus des modules de 3 tablettes pour augmenter l'espace de stockage. Dotée d'un trou pour l'installation de la machine à café.

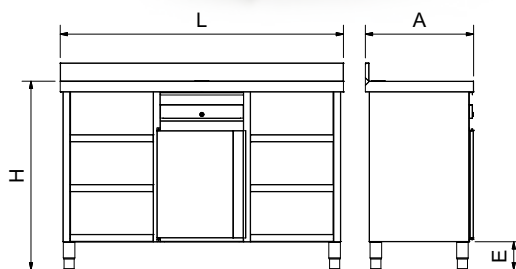
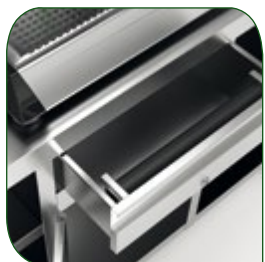

L	A	H	E	Kg	Barcode	€
1.570	600	1.040	150	70,58	074620	1.300,00



### Isla de cocina inox con encimera de madera de pino

Kitchen island with pinewood worktop  
Ile de cuisine inox avec plan de travail en bois de pin

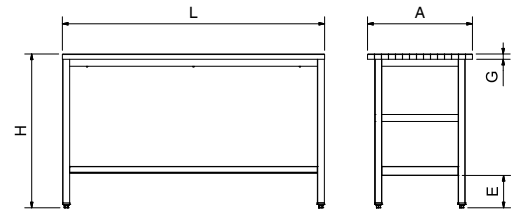

L	A	H	E	G	Kg	Barcode	€
1.000	600	880	200	30	33,0	076808	<b>650,00</b>
1.500	600	880	200	30	45,5	076810	<b>804,00</b>

### Isla de cocina inox con encimera de granito

Kitchen island with granite worktop  
Ile de cuisine inox avec plan de travail en granit

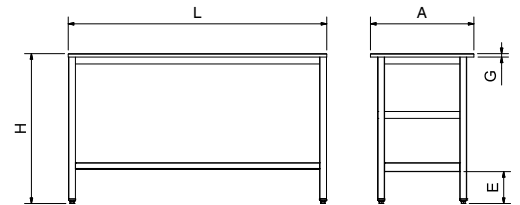

L	A	H	E	G	Kg	Barcode	€
1.000	600	870	200	20	49,0	076858	<b>658,00</b>
1.500	600	870	200	20	70,0	076860	<b>806,00</b>

### Mesa central inox con encimera de cristal traslúcido

Inox center table with translucent glass worktop  
Table centrale inox avec plan de travail en verre

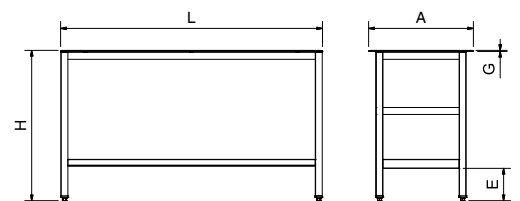

L	A	H	E	G	Kg	Barcode	€
1.000	600	860	200	6	25,9	076878	<b>703,00</b>
1.500	600	860	200	6	29,8	076880	<b>875,00</b>



## Punto de venta portátil de jamones

Mobile sale point of hams

Point de vente de jambon portable



### Características de fabricación:

- Ruedas de  $\varnothing 75$  mm.
- 2 cajones pequeños
- 1 cajón grande
- 2 puertas abatibles
- 1 contenedor verde 486026
- 1 Portacuchillos con envoltivo
- 1 Dispensador de 1 caja de guantes
- 1 Dispensador de papel y bolsas triple
- 1 Kit portarrollos
- 1 Pletina de 1500 mm. con 12 ganchos para jamones
- 1 base de jamonero giratorio basculante RT-3D
- 3 jamoneros giratorios RT-2D
- 1 fibra negra de 500x465x20 mm. con agujero de desbarasado
- Espacio disponible para báscula

### Manufacturing characteristics:

- Wheels  $\varnothing 75$  mm.
- 2 small drawers
- 1 large drawer
- 2 folding doors
- 1 green container 486026
- 1 Knife holder with casing
- 1 Dispenser for 1 glove box
- 1 Triple dispenser for paper and bags
- 1 Roll holder kit
- 1 1500 mm bar with 12 hooks for hams
- 1 foot of tilting rotating ham holder RT-3D
- 3 rotary ham holders RT-2D
- 1 black board of 500x465x20 mm with hole for disposals
- Enough room for a scale

### Caractéristiques de fabrication:

- Roues  $\varnothing 75$  mm.
- 2 petits tiroirs
- 1 grand tiroir
- 2 portes ouvrantes
- 1 container vert 486026
- 1 Porte-couteau avec enveloppant
- 1 Distributeur de 1 boîte à gants
- 1 Distributeur triple papier et sac
- 1 Kit de support de rouleau
- 1 Plaque de 1500 mm. avec 12 crochets pour les jambons
- 1 base de porte-jambon rotatif basculant RT-3D
- 3 porte-jambons rotatifs RT-2D
- 1 plaque noire de 500x465x20 mm. avec trou pour déchets
- Espace disponible pour la balance.

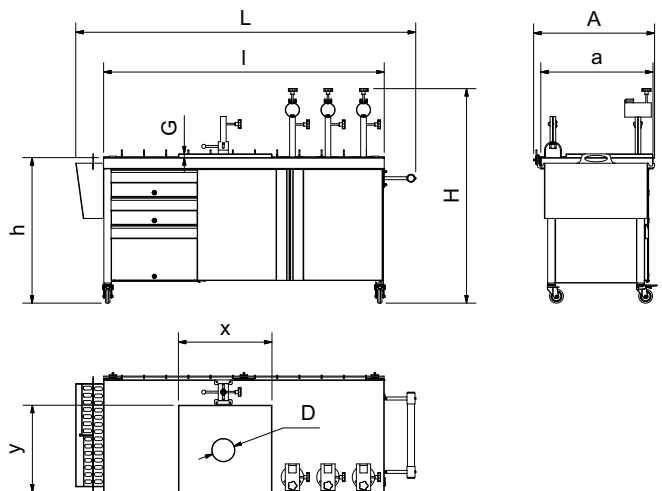

L	I	A	a	H	h	X	Y	G	D	Kg	Barcode	€
1.815	1.500	645	600	1150	780	500	465	20	120	98,00	075230	3.310,00

## Estante abatible de fibra para punto de venta portátil de jamones

Polyethylene hinged shelf for mobile sale point of hams

Étagère ouvrante en fibre pour point de vente de jambon portable

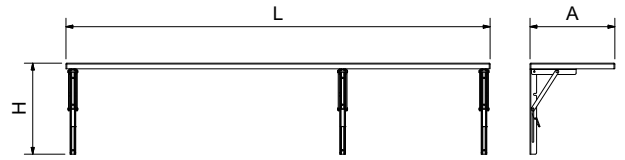

L	A	H	Kg	Barcode	€
1.500	300	325	10,3	075232	<b>306,00</b>

## Mesa jamonera RT-2D

Ham table RT-2D

Table porte-jambon RT-2D

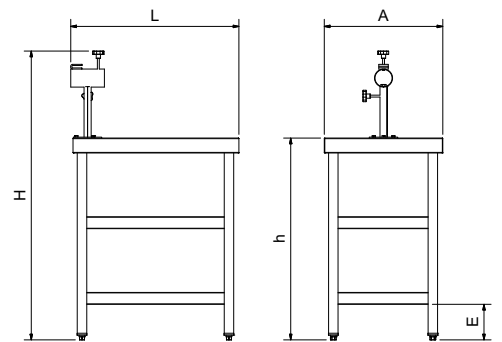

L	A	H	h	E	Kg	Barcode	€
710	500	1.220	850	150	20,00	074486	<b>615,00</b>

## Mesa jamonera RT-3D

Ham table RT-3D

Table porte-jambon RT-3D

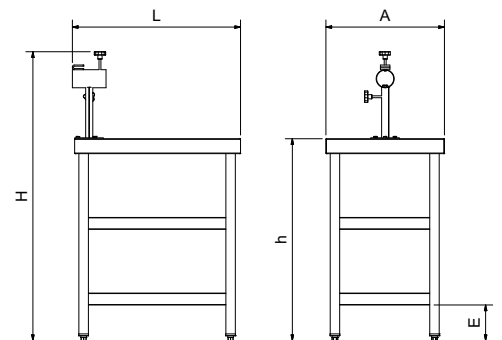
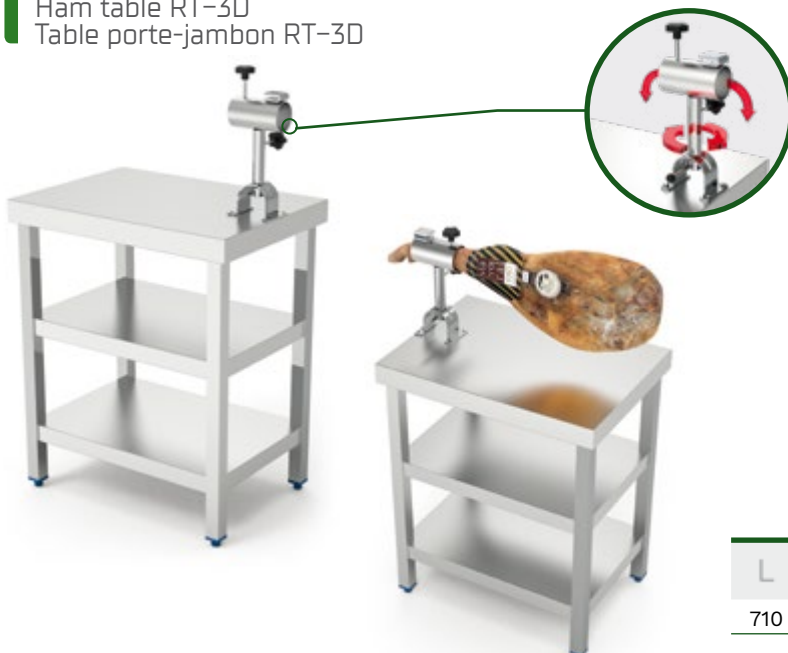

L	A	H	h	E	Kg	Barcode	€
710	500	1.220	850	150	20,00	074487	<b>695,00</b>

## Mesas centrales encimera de polietileno

Centre tables with polyethylene worktop  
Tables centrales dessus en polyéthylène



Es posible suministrarlas con fibra de diferente color. (Consultar)  
There is the possibility of supplying them with other colours of fibre. (Ask for it)  
Possibilité d'en fournir avec autres couleurs de fibre. (Demandez)

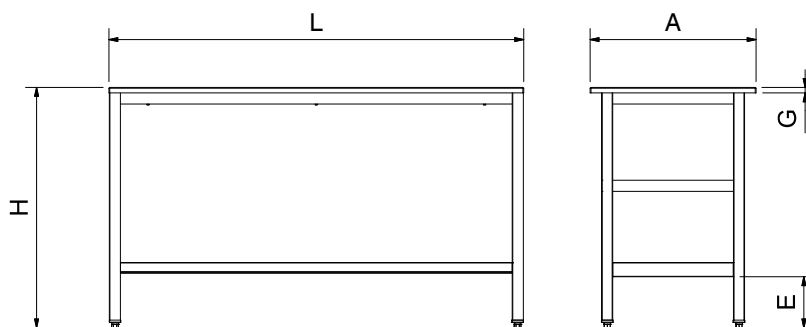

L	A	H	G	E	Kg	Barcode	€	Kg	Barcode	€	Kg	Barcode	€
1.000	500	870	20	200	22	071202	418,00	19	071402	382,00	5	2702028	116,00
						071252			071452				
1.500	500	870	20	200	34	071204	603,00	28	071404	549,00	9	2702048	134,00
						071254			071454				
2.000	500	870	20	200	46	071206	725,00	35	071406	660,00	14	2702068	151,00
						071256			071456				
1.000	600	870	20	200	25	071208	517,00	21	071408	470,00	6	2702088	134,00
						071258			071458				
1.500	600	870	20	200	37	071210	615,00	30	071410	558,00	10	2702108	151,00
						071260			071460				
2.000	600	870	20	200	53	071212	765,00	41	071412	697,00	15	2702128	169,00
						071262			071462				
1.000	700	870	20	200	28	071214	519,00	22	071414	472,00	8	2702148	151,00
						071264			071464				
1.500	700	870	20	200	42	071216	714,00	33	071416	648,00	13	2702168	169,00
						071266			071466				
2.000	700	870	20	200	57	071218	875,00	44	071418	797,00	19	2702188	186,00
						071268			071468				



Repuestos de fibras.  
Spare cutting boards.  
Plaques de découpe.

78

## Mesas de preparación centrales

Centre preparation tables  
Tables de préparation centrales



Es posible suministrarlas con fibra de diferente color. (Consultar)

There is the possibility of supplying them with other colours of fibre. (Ask for it)

Possibilité d'en fournir avec autres couleurs de fibre. (Demandez)

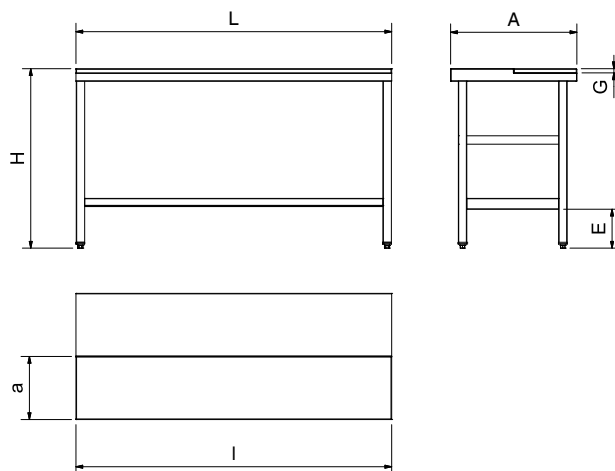

L	A	H	I	a	G	E	Kg	Barcode	€	Kg	Barcode	€	Kg	Barcode	€
1.000	600	850	1.000	300	20	200	37	071602 071652	<b>1.055,00</b>	32	071802 071852	<b>965,00</b>	6	2702088	<b>134,00</b>
1.500	600	850	1.500	300	20	200	50	071604 071654	<b>1.204,00</b>	44	071804 071854	<b>1.092,00</b>	10	2702108	<b>151,00</b>
2.000	600	850	2.000	300	20	200	66	071606 071656	<b>1.355,00</b>	54	071806 071856	<b>1.100,00</b>	15	2702128	<b>169,00</b>
1.000	700	850	1.000	300	20	200	42	071608 071658	<b>1.137,00</b>	37	071808 071858	<b>1.046,00</b>	8	2702148	<b>151,00</b>
1.500	700	850	1.500	300	20	200	56	071610 071660	<b>1.305,00</b>	47	071810 071860	<b>1.182,00</b>	13	2702168	<b>169,00</b>
2.000	700	850	2.000	300	20	200	75	071612 071662	<b>1.457,00</b>	61	071812 071862	<b>1.310,00</b>	19	2702188	<b>186,00</b>
1.000	800	850	1.000	300	20	200	47	071614 071664	<b>1.224,00</b>	39	071814 071864	<b>1.100,00</b>	10	2702208	<b>171,00</b>
1.500	800	850	1.500	300	20	200	62	071616 071666	<b>1.391,00</b>	51	071816 071866	<b>1.250,00</b>	14	2702228	<b>189,00</b>
2.000	800	850	2.000	300	20	200	82	071618 071668	<b>1.559,00</b>	66	071818 071868	<b>1.401,00</b>	21	2702248	<b>207,00</b>



Repuestos de fibras.  
Spare cutting boards.  
Plaques de découpe.

78

## Mesas de preparación murales

Wall preparation tables

Tables de préparation murales



Es posible suministrarlas con fibra de diferente color. (Consultar)

There is the possibility of supplying them with other colours of fibre. (Ask for it)

Possibilité d'en fournir avec autres couleurs de fibre. (Demandez)

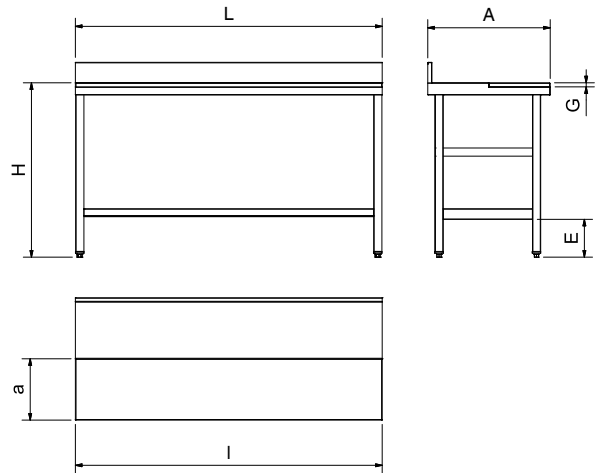

L	A	H	I	a	G	E	Kg	Barcode	€	Kg	Barcode	€	Kg	Barcode	€
1.000	600	850	1.000	300	20	200	37	072002 072052	<b>1.042,00</b>	33	072202 072252	<b>959,00</b>	6	2702088	<b>134,00</b>
1.500	600	850	1.500	300	20	200	49	072004 072054	<b>1.185,00</b>	42	072204 072254	<b>1.084,00</b>	10	2702108	<b>151,00</b>
2.000	600	850	2.000	300	20	200	64	072006 072056	<b>1.330,00</b>	52	072206 072256	<b>1.220,00</b>	15	2702128	<b>169,00</b>
1.000	700	850	1.000	300	20	200	39	072008 072058	<b>1.121,00</b>	34	072208 072258	<b>1.040,00</b>	8	2702148	<b>151,00</b>
1.500	700	850	1.500	300	20	200	54	072010 072060	<b>1.287,00</b>	46	072210 072260	<b>1.164,00</b>	12	2702168	<b>169,00</b>
2.000	700	850	2.000	300	20	200	73	072012 072062	<b>1.433,00</b>	59	072212 072262	<b>1.298,00</b>	18	2702188	<b>186,00</b>
1.000	800	850	1.000	300	20	200	44	072014 072064	<b>1.199,00</b>	36	072214 072264	<b>1.097,00</b>	10	2702208	<b>171,00</b>
1.500	800	850	1.500	300	20	200	60	072016 072066	<b>1.365,00</b>	50	072216 072266	<b>1.242,00</b>	14	2702228	<b>189,00</b>
2.000	800	850	2.000	300	20	200	78	072018 072068	<b>1.545,00</b>	62	072218 072268	<b>1.399,00</b>	21	2702248	<b>207,00</b>



Repuestos de fibras.  
Spare cutting boards.  
Plaques de découpe.

78

## Mesas centrales con reborde y desagüe

Centre tables with raised edge and drain  
Tables centrales avec rebord et trou d'écoulement

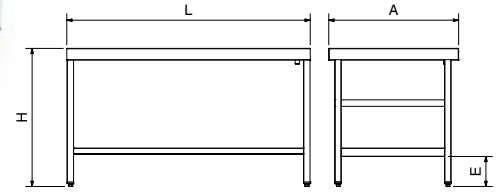

L	A	H	E	Kg	Barcode	€	Kg	Barcode	€	Kg	Barcode	€
1.000	600	850	200	46	073020	<b>1.075,00</b>	38	073220	<b>958,00</b>	11	2702088	<b>134,00</b>
1.500	600	850	200	54	073022	<b>1.189,00</b>	42	073222	<b>1.058,00</b>	15	2702108	<b>151,00</b>
2.000	600	850	200	76	073024	<b>1.286,00</b>	55	073224	<b>1.121,00</b>	25	2702128	<b>169,00</b>
1.000	700	850	200	49	073026	<b>1.164,00</b>	40	073226	<b>1.026,00</b>	12	2702148	<b>151,00</b>
1.500	700	850	200	58	073028	<b>1.284,00</b>	45	073228	<b>1.133,00</b>	16	2702168	<b>169,00</b>
2.000	700	850	200	81	073030	<b>1.400,00</b>	56	073230	<b>1.222,00</b>	26	2702188	<b>186,00</b>
1.000	800	850	200	38	073002	<b>1.211,00</b>	30	073202	<b>1.068,00</b>	10	2702208	<b>171,00</b>
1.500	800	850	200	51	073004	<b>1.332,00</b>	40	073204	<b>1.167,00</b>	14	2702228	<b>189,00</b>
2.000	800	850	200	67	073006	<b>1.467,00</b>	50	073206	<b>1.277,00</b>	21	2702248	<b>207,00</b>

## Mesas murales con reborde y desagüe

Wall tables with raised edge and drain  
Tables murales avec rebord et trou d'écoulement

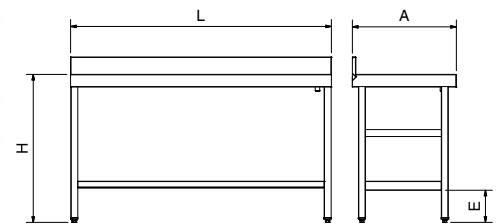

L	A	H	E	Kg	Barcode	€	Kg	Barcode	€	Kg	Barcode	€
1.000	600	850	200	30	073402	<b>1.075,00</b>	25	073602	<b>958,00</b>	6	2702088	<b>134,00</b>
1.500	600	850	200	39	073404	<b>1.189,00</b>	32	073604	<b>1.058,00</b>	10	2702108	<b>151,00</b>
2.000	600	850	200	51	073406	<b>1.286,00</b>	42	073606	<b>1.121,00</b>	15	2702128	<b>169,00</b>
1.000	700	850	200	33	073408	<b>1.164,00</b>	28	073608	<b>1.026,00</b>	8	2702148	<b>151,00</b>
1.500	700	850	200	46	073410	<b>1.284,00</b>	38	073610	<b>1.133,00</b>	12	2702168	<b>169,00</b>
2.000	700	850	200	60	073412	<b>1.400,00</b>	46	073612	<b>1.222,00</b>	18	2702188	<b>186,00</b>
1.000	800	850	200	36	073414	<b>1.211,00</b>	29	073614	<b>1.068,00</b>	10	2702208	<b>171,00</b>
1.500	800	850	200	49	073416	<b>1.332,00</b>	39	073616	<b>1.167,00</b>	14	2702228	<b>189,00</b>
2.000	800	850	200	65	073418	<b>1.467,00</b>	48	073618	<b>1.277,00</b>	21	2702248	<b>207,00</b>



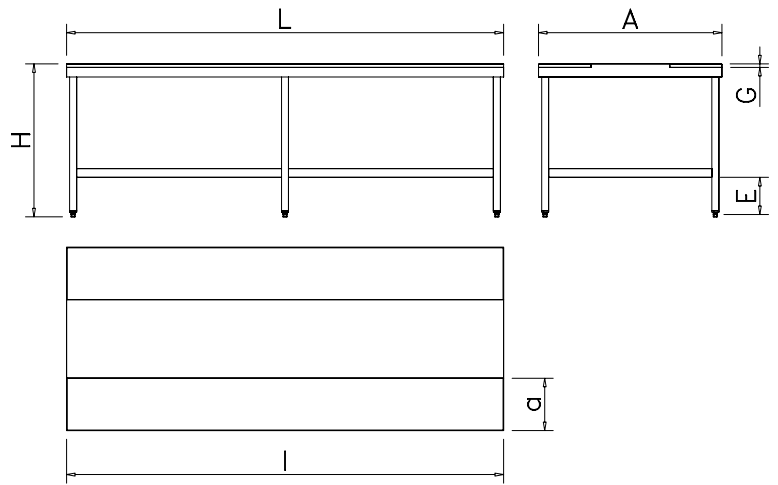

## Mesas de despiece

Quartering tables  
Tables de découpage



Es posible suministrarlas con fibra de diferente color. (Consultar)

There is the possibility of supplying them with other colours of fibre. (Ask for it)  
Possibilité d'en fournir avec autres couleurs de fibre. (Demandez)

												
L	A	H	I	a	G	E	Kg		€	Kg		€
1.500	1.050	850	1.500	300	20	200	78	072402	1.792,00	65	072602	1.792,00
								072452			072652	
2.000	1.050	850	2.000	300	20	200	105	072404	2.105,00	86	072604	2.105,00
								072454			072654	
1.500	1.300	850	1.500	300	20	200	91	072410	1.988,00	73	072610	1.988,00
								072460			072660	
2.000	1.300	850	2.000	300	20	200	125	072412	2.289,00	97	072612	2.289,00
								072462			072662	



Repuestos de fibras.  
Spare cutting boards.  
Plaques de découpe.

78



# Contenedor inox para vaciado de bandejas de comida rápida fast-food

Stainless steel waste bin for fast food restaurants

Poubelle en acier inoxydable spéciale snack restauration rapide Fast-food



Apertura a pedal  
Foot pedal opening  
Ouverture à pédale



080662

080660

## Características de fabricación:

Fabricado totalmente con acero inoxidable. Sistema patentado de pedal. Permitirá al usuario abrir la trampilla sin necesidad de usar las manos. La trampilla también se puede abrir con la mano en caso de requerirlo. Las varillas de la parte superior del mueble facilitan la colocación de las bandejas. La tolva de caída de los desperdicios es de una sola pieza y no posee juntas ni huecos, lo que facilita la limpieza. Asa de la puerta ergonómica. El contenedor posee dos ruedas, lo que permite desplazarlo con poco esfuerzo. Provisto de dos tacos regulables en altura para adaptarse a cualquier clase de suelo, evitando desplazamientos accidentales o no deseados. Insonorizado en todas sus piezas.

## Manufacturing characteristics:

Fully made of stainless steel. Pedal operated patented system. It will allow the user to open the lid avoiding the use of his hands. The lid can also be opened with the hand if necessary. Rods on the top that make easier the placing of the empty trays. Receptacle for scraps made in one only piece, without joints or hollows. Ergonomic handle. It can be moved effortlessly by means of two wheels. It can be adapted to any floor unevenness thanks to two adjustable blocks. All its components are soundproofed.



486074 36,00 393

Contenedor de plástico con tapa 55 lts  
Plastic bin with lid 55 lts  
Conteneur 55 lts



480664 19,00

Adhesivo para pedal  
Sticker for pedal  
Autocollant pour pédale



480662 19,00

Adhesivo trampilla  
Sticker for lid  
Autocollant pour trappe



486022 31,00 386

Contenedor de desperdicios 95 lts  
Waste bin 95 lts  
Conteneur à ordures 95 lts



485016 4,00

Ruedas  
Wheels  
Rouelles

**Incluido** / Included / Inclus

**Opcional** / Optional / Optionnel

**Caractéristiques de fabrication:**  
Fabricado totalmente en acero inoxidable. Sistema patentado de pedal. Permitirá al usuario abrir la trampilla sin necesidad de usar las manos. La trampilla también se puede abrir con la mano en caso de requerirlo. Las varillas de la parte superior del mueble facilitan el rangement des plateaux. La trémie de déchets est construite dans une seule pièce et elle ne possède pas de joints, ce qui facilite le nettoyage. Tireur ergonomique. La poubelle a deux rouelles, ce qui permet de le déplacer sans effort. Elle est pourvue de deux vérins réglables en hauteur pour s'adapter au plancher. Toute la poubelle est insonorisée.

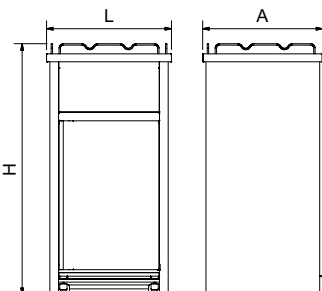

L	A	H	liters	Kg	Barcode	€
625	600	1.255	95 lt	46,0	080660	<b>1.150,00</b>
540	410	1.016	55 lt	30,5	080662	<b>1.000,00</b>

## Boxes modulares

Modular boxes  
Boxes modulaires



Con este sistema de boxes modulares ya puede configurar a su medida las mesas, fregaderos, estanterías, etc.

Basados en el sistema de medidas internacionales GASTRONORM (GN) están fabricados íntegramente en acero inoxidable. Su diseño moderno y funcional permite adaptar guías, cajones, cubetas, puertas etc.

Now you can tailor your tables, sinks, shelves and so on with this system of modular boxes.

Based on the international dimensions Gastronorm, it is made totally from stainless steel. Its innovative and functional design allows the fitting of elements such as guides, drawers, pans, doors, etc.

Avec le système de boxes modulaires maintenant vous pouvez adapter à vos besoins tables, éviers, étagères, etc.

Ce système, basé dans les mesures internationales Gastronorm, est fabriqué totalement en acier inoxydable. Sa conception moderne et fonctionnelle permet d'adapter guides, tiroirs, bacs, portes, etc.

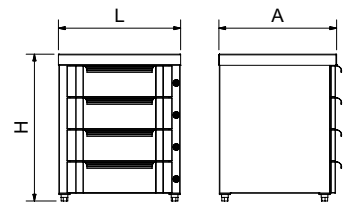

Posibilidad de acoplarles ruedas con y sin frenos. Wheels assembly possible, with or without brakes. Possibilité de mettre des roulettes avec et sans freins.

	L	A	H	H	GN	Kg	Barcode	€
 <p><b>Box modular 4 cajones</b> Box 4 drawers unit Box modulaire 4 tiroirs</p>	439	423	530	600		19,00	075002	<b>980,00</b>
 <p><b>Box modular 1 cajón y puerta</b> Box 1 drawer and door unit Box modulaire 1 tiroir et porte</p>	439	423	530	600		16,00	075004	<b>932,00</b>
 <p><b>Box modular guías GN</b> Box GN guides unit Box modulaire GN guides</p>	439	423	530	600	2/3	10,00	075006	<b>633,00</b>
 <p><b>Box modular 1 puerta</b> Box 1 door unit Box modulaire 1 porte</p>	439	423	530	600		13,00	075008	<b>713,00</b>

## Kit golpeador para cajón modular

Coffee grounds striker kit for modular drawer

Kit de barre pour vider le marc de café pour tiroir modulaire



Valido solo para cajones Fricosmos.  
Valid only for Fricosmos drawers.  
Valable uniquement pour les tiroirs Fricosmos.



		€
Precio con montaje en fábrica Assembly price Prix pour accoupler	075020	<b>100,00</b>

L	A	H	Kg		€
330	75,5	89	2,1	275128	<b>80,00</b>

## Estanterías de sobremesa

Worktop shelves

Etagères à poser sur table





Estantes regulables en altura  
Adjustable shelves  
Etagères réglables en hauteur

Entrepasño opcional  
Optional shelf  
Tablette en option

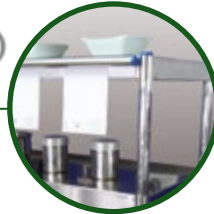

 €
 
 081802 25,00 462

Porta-notas mural  
Wall mounted tab grabber  
Porte-notes mural





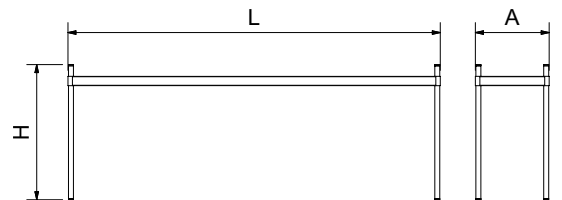



 Op  
 085014 4 X 10€

Kit de fijación  
Fixing kit  
Kit de fixation



Instalación de sobremesa con o sin fijación.  
Installation on worktop with or without fixing.  
Installation sur dessus avec ou sans fixation.

 Incluido / Included / Inclus  
 Opcional / Optional / Optionnel

		€			€			
L	A	H	Kg		€	Kg		€
991	391	677	3,8	076060	<b>205,00</b>	3,6	276060	<b>111,00</b>
1.391	391	677	5,1	076062	<b>253,00</b>	4,9	276062	<b>136,00</b>
1.891	391	677	6,7	076064	<b>301,00</b>	6,5	276064	<b>164,00</b>

## Estanterías suspendidas

Hanging wall shelves  
Étagères suspendues



Fabricadas totalmente en acero inoxidable. Esta gama de estanterías suspendidas está diseñada para ayudarle a organizar su espacio de trabajo con seguridad e higiene.

Los estantes son regulables en altura y cuentan con reborde perimetral que dará seguridad al contenido del estante, evitando a su vez posibles derrames y caídas de objetos.

Sus detalles de fabricación proporcionan firmeza y seguridad a toda la estructura.

Totally made in stainless steel. This range of hanging wall shelves is designed to help you to organize your working space in a safe and hygienic way. Their shelves are height adjustable, and are provided with a perimeter flange that will allow a secure storage and will avoid any accidental edge leakage. The particular manufacturing features provide stability and robustness to the whole structure.

Fabriquée entièrement en acier inoxydable cette gamme de rayonnages suspendus est conçu pour vous aider à organiser votre espace de travail en total sécurité et hygiène.

Les étagères sont réglables en hauteur et ont un rebord qui donnera sécurité au contenu de l'étagère en empêchant les possibles déversements. Ces détails de fabrication fournissent fermeté et sécurité à toute la structure.

015400 4 X 49€

Kit de fijación a techo para estanterías suspendidas  
Ceiling fixing kit for hanging shelves  
Kit de montage pour plafond pour étagères suspendues



081802 25 462

Porta-notas mural  
Wall-mounted tab grabber  
Porte-notes mural

486024 24 389

Contenedor de desperdicios y reciclaje  
Waste and recycling container  
Conteneur à ordures et recyclage

276044 35 320

Adaptador contenedor desperdicios  
Cutlery basket adaptor for service trolleys  
Adaptateur de conteneurs pour chariots de service

454860 2,50 460

Cestillo de plástico para cubiertos  
Plastic cutlery basket  
Plateau à couverts en plastique

276042 18 320

Adaptador de cestillos cuberteros  
Container adaptor for service trolleys  
Adaptateur de panier à utensiles de cuisine pour chariots de service

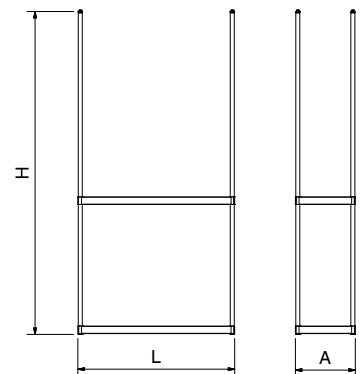

Incluido / Included / Inclus  
Opcional / Optional / Optionnel

⚠ Posibilidad de añadir estantes adicionales. Preparado para atornillar mediante taco expansor.  
Possibility of adding additional shelves. Ready for fixing with expansion shell anchors.  
Des étagères supplémentaires peuvent être ajoutées.  
Prépare pour le vissage au moyen d'un bouchon d'expansion.

L	A	H	Kg	Barcode	€	Kg	Barcode	€
991	391	2.000	8,0	015402	<b>323,00</b>	3,6	276060	<b>111,00</b>
1.391	391	2.000	10,6	015404	<b>391,00</b>	4,9	276062	<b>136,00</b>
1.891	391	2.000	13,8	015406	<b>469,00</b>	6,5	276064	<b>164,00</b>

## Calentador de platos para estante de sobremesa

Warming tray for desktop shelves  
Bande chauffante pour étagères à poser sur table



	Tensión Voltage Tension	Frecuencia Frequency Frequence	Potencia Power Puissance			
L				Kg	€	
955	220 V	50 Hz	1.000 W	4,8	076070	<b>529,00</b>
1.355	220 V	50 Hz	1.500 W	6,0	076072	<b>588,00</b>
1.855	220 V	50 Hz	1.500 W	7,0	076074	<b>647,00</b>

## Lámpara para calentar platos

Food warmer lamp  
Lampe pour chauffer des plats

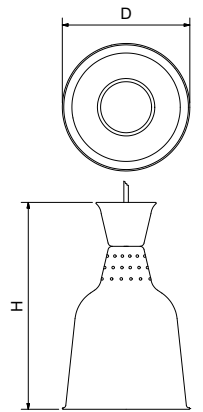

	Tensión Voltage Tension	Frecuencia Frequency Frequence	Potencia Power Puissance			
D H				Gr	€	
180 300	220 V	50 Hz	250 W	800	476090	<b>97,00</b>

## Bombilla calentadora inastillable

Shatterproof heater bulb  
Ampoule chauffante incassable



Tensión Voltage Tension	Frecuencia Frequency Frequence	Potencia Power Puissance		Kg	€
220 V	50 Hz	250 W		200	476091 <b>31,00</b>
220 V	50 Hz	250 W		200	476088 <b>35,00</b>

## Plafón para calentar platos

Commercial radiant heater for food warming  
Plafond pour chauffer des plats



### Características:

Válido para acoplarlo bajo encimera o estante, incluye fijaciones, también admite la posibilidad de suspenderlo mediante las cadenas incluidas.

Characteristics:  
Possibility of being assembled under worktop or under shelf. It can also be hanged with the provided chains.

Caractéristiques:  
Apte pour s'ajuster sous le plan de travail ou étagère, les fixations sont incluses. Peut aussi se suspendre avec les chaînes qui sont incluses.

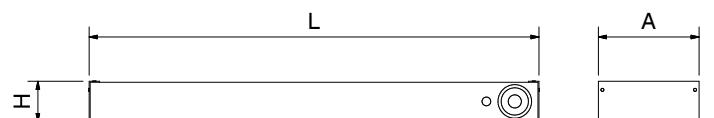

	Tensión Voltage Tension	Frecuencia Frequency Frequence	Potencia Power Puissance			
L A H				Kg	€	
613 113 65	220 V	50 Hz	575 W	5,0	476092	<b>395,00</b>

## Calentador de platos mediante aire

Air flow dish warmer  
Chauffe plats par air



Diseñado para ser instalado dentro de cualquiera de nuestros muebles o armarios con puertas, convirtiendo el mueble neutro en un mueble caliente a una temperatura constante, gracias a su termostato regulable entre 30 y 90 °C.

Designed to be installed inside any of our furniture or cabinets with doors, turning the neutral furniture into a hot furniture at a constant temperature, thanks to its adjustable thermostat between 30° and 90° C.

Conçu pour être installé dans n'importe lequel de nos meubles ou armoires avec portes, transformant le meuble neutre en un meuble chaud à température constante, grâce à son thermostat réglable entre 30° et 90° C.

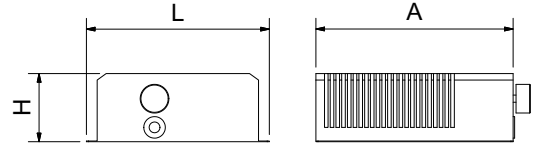

L	A	H	Tensión Voltage Tension	Frecuencia Frequency Frecuence	Potencia Power Puissance				€
275	230	95	230 V	50/60 Hz	2.000 W	185 m3/h.	3,50	476096	<b>260,00</b>

## Dispensador de vasos

Cup dispenser  
Distributeur de verres

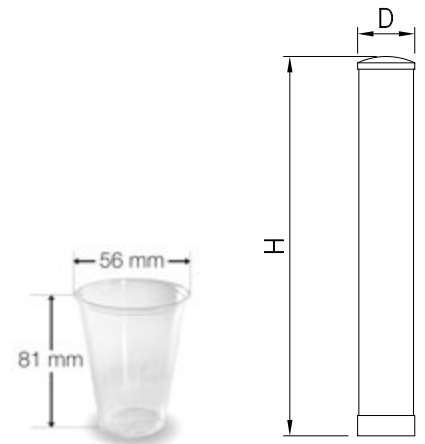

D	H			€
90	597	450	483270	<b>102,00</b>

## Puerta rodante para contenedores

Rolling door for waste bin  
Porte roulante pour conteneur

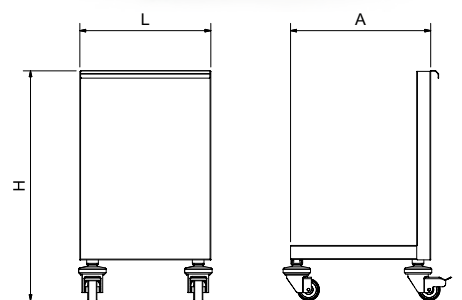

L	A	H			€
460	500	780	11	074472	<b>350,00</b>

## Peto lateral reversible para mesas

Reversible side upstand for tables  
Dossieret latéral réversible pour tables

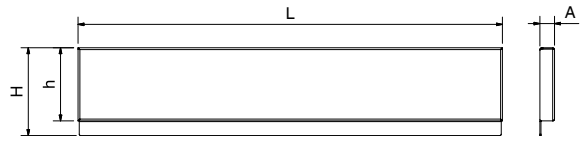
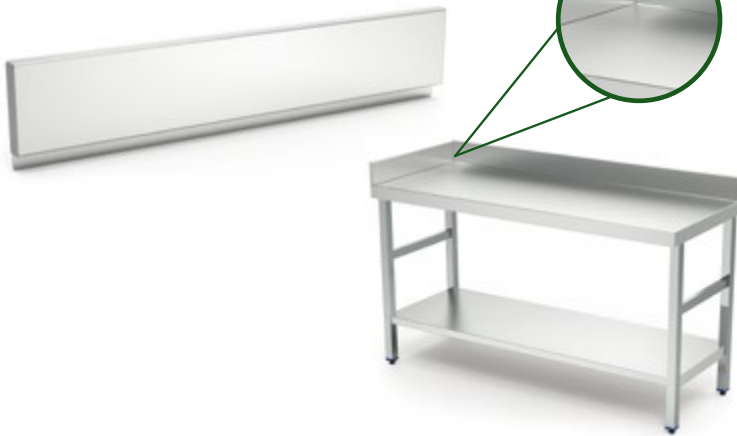

L	A	H	h	Kg	Barcode	€
480	20	120	100	0,98	070302	<b>60,00</b>
580	20	120	100	1,17	070304	<b>63,00</b>
680	20	120	100	1,37	070306	<b>65,00</b>

## Tapa juntas de unión para mesas y fregaderos

Stainless steel flashing for tables and sinks  
Couvre-joint pour union de tables et éviers



### Características:

Válido para la unión entre mesas y/o fregaderos.

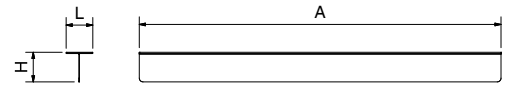

Characteristics:  
Especially suitable for connecting tables and/or sinks.

Caractéristiques:  
Valable pour l'union de tables et / ou éviers.

L	A	H	Gr	Barcode	€
475	35	39	320	074480	<b>19,00</b>
575	35	39	390	074482	<b>19,00</b>
675	35	39	460	074484	<b>20,00</b>

## Fregaderos soldados a mesas

Sink units welded to tables  
Évier soudés aux tables

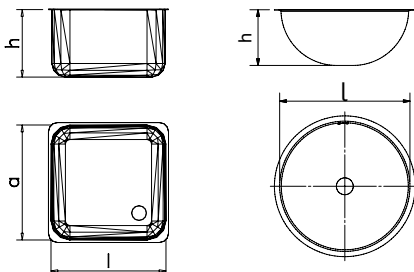

l	a	h	Barcode	€
260	Ø	115	057003	<b>353,00</b>
390	Ø	150	057005	<b>385,00</b>
370	340	145	057006	<b>545,00</b>
400	400	250	057008	<b>420,00</b>
400	400	300	057010	<b>426,00</b>
500	500	300	057012	<b>453,00</b>
500	500	350	057014	<b>442,00</b>
600	450	300	057016	<b>498,00</b>
600	450	300	057017	<b>616,00</b>
600	450	350	057018	<b>614,00</b>
600	450	350	057019	<b>614,00</b>
600	500	300	057020	<b>605,00</b>
600	500	300	057021	<b>559,00</b>
600	500	350	057022	<b>551,00</b>
800	420	350	057024	<b>875,00</b>
800	420	350	057026	<b>875,00</b>
1.060	420	350	057028	<b>909,00</b>
1.060	420	350	057030	<b>909,00</b>

## Campana extractora mural acero inoxidable

Wall-mounted stainless steel exhaust hood  
Hotte de cuisine murale en acier inoxydable



### Características:

Construidas en acero inoxidable.  
Sin motor.  
Bandeja recoge-grasas con válvula de desengrase.  
Filtros inoxidables de 490x490x50 mm.

### Characteristics:

Made of stainless steel.  
Extractor fan motor not included.  
Grease tray with valve for evacuation.  
Stainless steel filters 490x490x50 mm.

### Caractéristiques:

Fabriquées en acier inoxydable.  
Sans moteur.  
Bac de récupération des graisses avec vanne de dégraissage.  
Filtres inoxidables 490x490x50 mm.

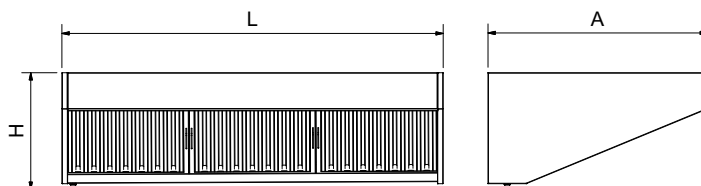

L	A	H				€
987	850	452	2	18,30	076602	<b>589,00</b>
1.477	850	452	3	24,40	076604	<b>730,00</b>
1.968	850	452	4	31,60	076606	<b>809,00</b>

## Filtro inoxidable para campana extractora industrial

Stainless steel filter for commercial exhaust hood  
Filtre inox pour hotte de cuisine industrielle



L	A	H			€
490	490	50	2,05	476702	<b>25,00</b>



## Carros de servicio

Service trolley  
Chariot de service



### Características:

Concebido para un uso intensivo profesional.

Estantes regulables en altura. Pliegues reforzados con pestaña aplastada, lo que evita accidentes durante su uso y limpieza y aumenta la capacidad de carga hasta 140 kg por nivel. Posibilidad de añadir más estantes. Máxima carga admisible 280 kg.

Se suministra con 4 ruedas giratorias, dos de ellas con freno, diámetro 125 mm, provistas de superficie de rodadura de baja sonoridad.

Parachoques circulares de 95 mm de diámetro.



**\*HASTA 140 Kg**  
de carga por estante  
Up to 140 kgs of load  
strength per shelf  
Jusqu'à 140 kgs  
de résistance par étage

### Characteristics:

Designed for a heavy-duty professional use.

Adjustable shelves, reinforced by special fold with crushed fringe. This system avoids any bad cut when handling and cleaning it and increases its load strength. Every shelf can support up to 140 kgs evenly distributed. Possibility of increasing its number of shelves. Maximum load strength 280 kgs.

Provided with 4 castors of diameter 125 mm., 2 of them with brake, with tread band of low noise level.

Rounded bumpers of 95 mm. of diameter.

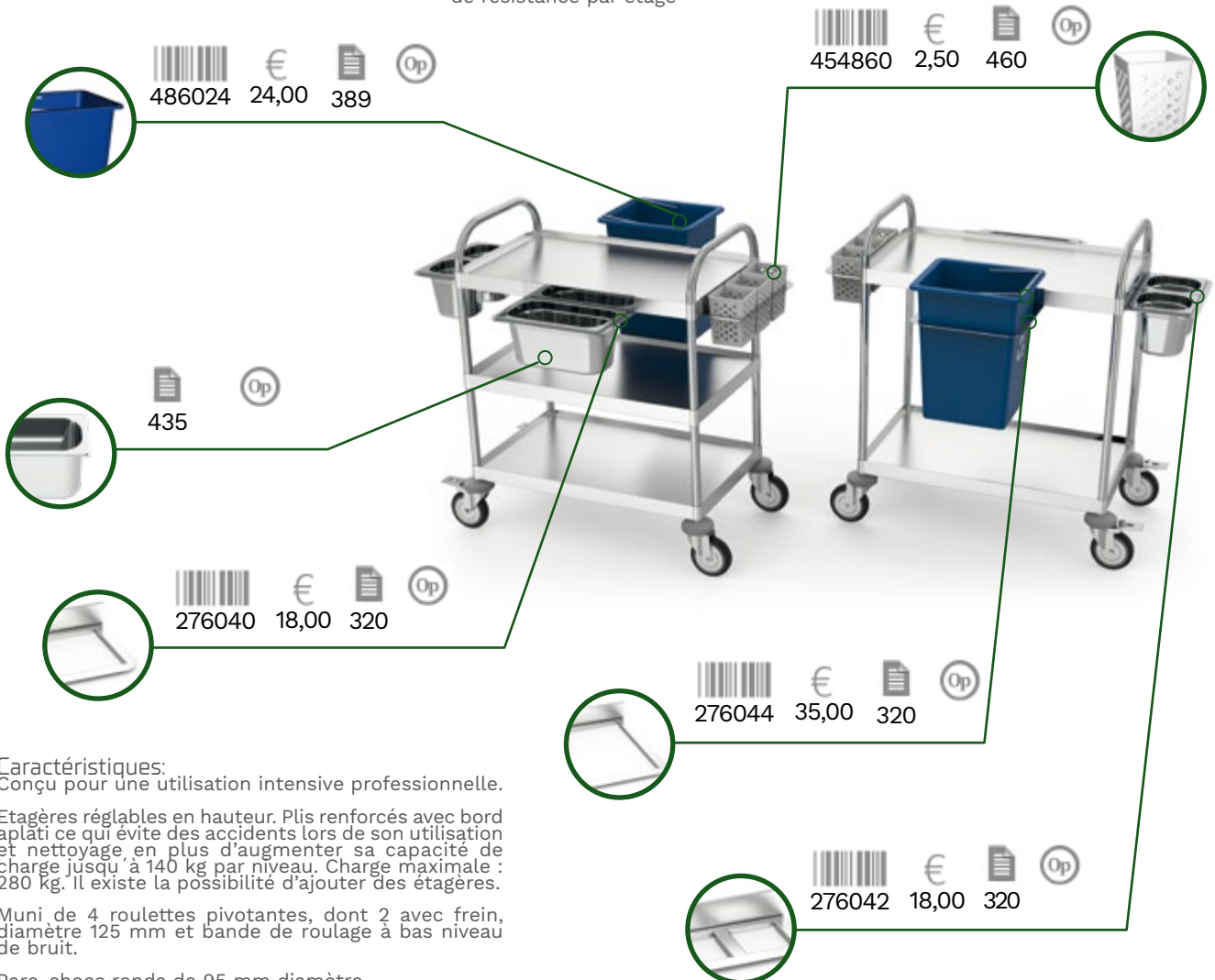

### Caractéristiques:

Conçu pour une utilisation intensive professionnelle.

Etagères réglables en hauteur. Plis renforcés avec bord aplati ce qui évite des accidents lors de son utilisation et nettoyage, en plus d'augmenter sa capacité de charge jusqu'à 140 kg par niveau. Charge maximale : 280 kg. Il existe la possibilité d'ajouter des étagères.

Muni de 4 roulettes pivotantes, dont 2 avec frein, diamètre 125 mm et bande de roulage à bas niveau de bruit.

Pare-chocs ronds de 95 mm diamètre.

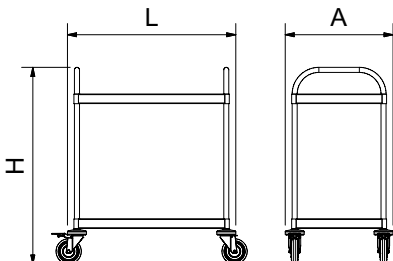

										Entrepaino opcional Optional shelf Tablette en option	
L	A	H	Kg	Kg	Barcode	€	Kg	Barcode	€		
835	535	975	140	15	076002	<b>432,00</b>	3,5	276050	<b>84,00</b>		
1.035	535	975	120	16	076004	<b>444,00</b>	4,3	276052	<b>102,00</b>		
1.235	535	975	120	18	076006	<b>506,00</b>	5,0	276054	<b>125,00</b>		

\*El peso máximo soportado está calculado para una carga repartida uniformemente sobre toda la superficie del estante.  
The weight capacity is calculated for an evenly distributed load over the entire surface of the shelf.  
La capacité de charge est calculée pour une charge uniformément répartie sur toute la surface du plateau.

### Adaptador de cubetas GN 1/3 y 1/6 para carros de servicio

Gastronorm trays adaptor GN 1/3 and 1/6 for service trolleys

Adaptateur de bacs Gastronorm 1/3 et 1/6 pour chariots de service

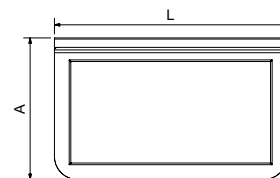

L	A	Gr	Barcode	€
355	216	780	276040	<b>18,00</b>

### Adaptador de cestillos cuberteros para carros de servicio

Cutlery basket adaptor for service trolleys

Adaptateur de panier à utensiles de cuisine pour chariots de service

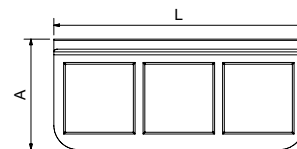

L	A	Gr	Barcode	€
360	159	792	276042	<b>18,00</b>

### Adaptador de contenedores para carros de servicio

Container adaptor for service trolleys

Adaptateur de conteneurs pour chariots de service

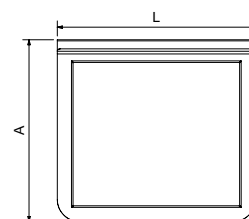

L	A	Gr	Barcode	€
315	289	764	276044	<b>35,00</b>

### Carro de recogida

Collection trolley

Chariot de ramassage

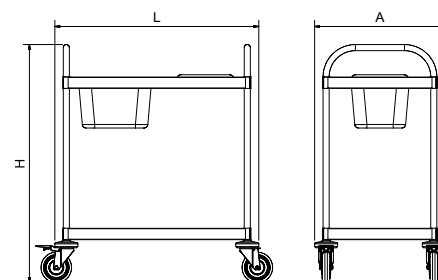

L	A	H	Kg	Barcode	€
835	535	975	15,5	076020	<b>518,00</b>
1.035	535	975	16,5	076022	<b>540,00</b>
1.235	535	975	18,5	076024	<b>658,00</b>

### Mesa / Carro auxiliar multifuncional para instrumental o de servicio con ruedas

Multifunctional auxiliary table / trolley for equipment or service with wheels

Table / chariot auxiliaire multifonctionnel pour instruments ou service à roulettes

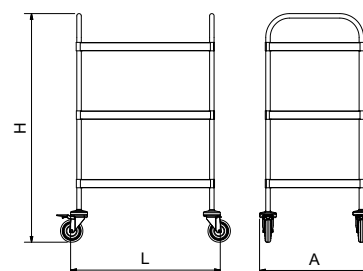

















L	A	H	Kg	Barcode	€
835	615	1.275	19,90	076010	<b>650,00</b>

## Repuestos para carros de servicio y recogida

Spare parts for service and collection trolleys

Pièces de rechange pour chariots de service et ramassage

	<b>Bastidor para carro de servicio</b> Frame for service trolley Châssis pour chariot de service	1,8	276030	<b>61,00</b>					
	<b>Entrepaño para carro de servicio de 800x500 mm.</b> Shelf for service trolley of 800x500 mm. Étagère pour chariot de service de 800x500 mm.	3,5	276050	<b>84,00</b>					
	<b>Entrepaño para carro de servicio de 1.000x500 mm.</b> Shelf for service trolley of 1.000x500 mm. Étagère pour chariot de service de 1.000x500 mm.	4,5	276052	<b>102,00</b>					
	<b>Entrepaño para carro de servicio de 1.200x500 mm.</b> Shelf for service trolley of 1.200x500 mm. Étagère pour chariot de service de 1.200x500 mm.	5,5	276054	<b>125,00</b>					
	<b>Rueda galvanizada con freno de diámetro 125 mm.</b> Galvanized wheel of diameter 125 mm. with brake Roulette galvanisée avec frein diamètre 125 mm.	0,8	485010	<b>21,00</b>					
	<b>Rueda galvanizada sin freno de diámetro 125 mm.</b> Galvanized wheel of diameter 125 mm. without brake Roulette galvanisée sans frein diamètre 125 mm.	0,7	485012	<b>17,00</b>					
	<b>Parachoques para carros de servicio</b> Bumper for service trolleys Pare-chocs pour chariots de service	0,2	485050	<b>5,00</b>					
	<b>Kit de acoplamiento de rueda a bastidor de carros de servicio</b> Wheel fixing kit for service trolleys frame Kit d'accouplement de roulette pour châssis de chariots de service	0,12	085014	<b>10,00</b>					

	<b>Rueda anticalórica con freno en acero inoxidable ø100 mm.</b> Heat resistant swivel wheel with brake in stainless steel ø100 mm. Roulette résistante à la chaleur avec frein en acier inoxydable ø100 mm.	175 Kg.	-40 a 280°C	840	485026	<b>70,00</b>					
	<b>Rueda anticalórica en acero inoxidable ø100 mm.</b> Heat resistant swivel wheel in stainless steel ø100 mm. Roulette résistante à la chaleur en acier inoxydable ø100 mm.	175 Kg.	-40 a 280°C	840	485028	<b>55,00</b>					



## Carro de manutención con ruedas y desagüe

Washing trolley with drain  
Chariot à lavage avec écoulement



2 ruedas fijas y 2 giratorias de Ø 80 mm.

2 fixed wheels and 2 rotating wheels Ø 80 mm.

2 roues fixes et 2 roues tournantes Ø 80 mm.



481071 45,00



Tapa para carro de manutención 481070  
Lid for washing trolley with drain 481070  
Couvercle pour chariot de manutention 481070

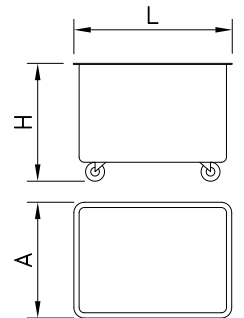

L	A	H	liters	Kg	Barcode	€
750	550	560	155	8,20	481070	<b>273,00</b>

## Contenedor para transporte de hielo

Trolley for ice transportation  
Conteneur à ordures

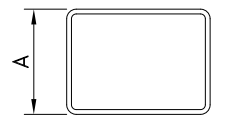
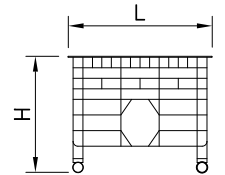

L	A	H	liters	Kg	Barcode	€
1.040	640	825	285 lts	19,50	481080	<b>335,00</b>

## Contenedor para hielo

Trolley for ice transportation  
Conteneur à ordures



### Características:

Preparados para contacto alimenticio.  
Fabricado en polietileno de alta densidad (HDPE).  
Soporta temperaturas de -20°C hasta +70°C.  
Con tapon para desagüe.

### Characteristics:

Suitable for food contact.  
Made of high-density polyethylene (HDPE).  
It withstands temperatures from -20°C to +70°C.  
With drain plug.

### Caractéristiques:

Apte pour le contact alimentaire.  
Fabriqué en polyéthylène de haute densité (HDPE).  
Résiste à des températures allant de -20°C jusqu'à +70°C.  
Avec bouchon pour l'évacuation.

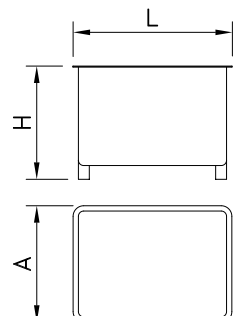

481074 394,00



Base rodante galvanizada  
Galvanized rolling base  
Base roulante galvanisée



L	A	H	liters	Kg	Barcode	€
790	600	685	210 lts	8,80	481072	<b>336,00</b>

## Carro de lavado con desagüe en acero inoxidable

Washing trolley with drainage system in stainless steel  
Chariot de lavage avec système d'évacuation en acier inoxydable

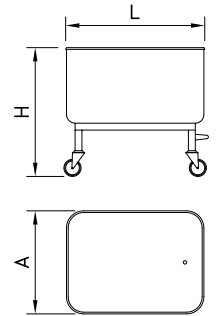

L	A	H	h	kg	Barcode	€
800	600	750	200	11,00	481082	<b>672,00</b>

## Carro bañera para elevador

Tote bin for lift  
Chariot baignoire pour élévateur

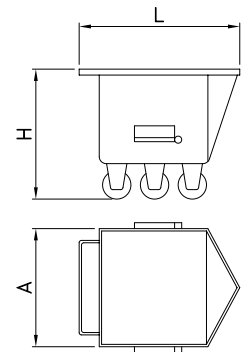

L	A	H	h	kg	Barcode	€
780	650	675	200	40	481078	<b>850,00</b>

## Carros Gastronorm

Gastronorm trolleys  
Chariots Gastronorm

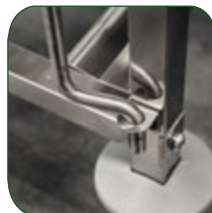

### Características:

4 ruedas giratorias, 2 de ellas con freno.

### Characteristics:

4 swivel wheels, 2 of them with brakes.

### Caractéristiques:

4 roues pivotantes, dont 2 avec freins.

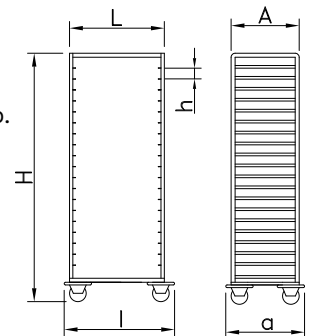

L	A	H	h	a	l	EN	kg	Barcode	€	
380	550	990	80	695	535	1/1	7	15	476016	<b>260,00</b>
380	555	1.725	78	700	535	1/1	20	16	476020	<b>349,00</b>
585	670	1.865	78	740	655	2/1	20	21	476022	<b>390,00</b>

## Carro Euronorm

Euronorm tray trolley  
Chariot pour plateaux Euronorm



### Características:

4 ruedas giratorias, 2 de ellas con freno.

### Characteristics:

4 swivel wheels, 2 of them with brakes.

### Caractéristiques:

4 roues pivotantes, dont 2 avec freins.

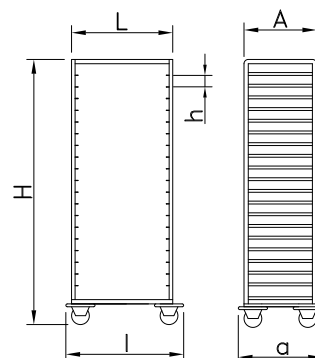

L	A	H	a	h	🔧	Kg	📊	€
465	630	1.725	700	535	20	19	476010	<b>350,00</b>

## Carro bandejero multinorma (Gastronorm / Euronorm / Pastelería)

Multi-standard tray trolley (Gastronorm / Euronorm / Pastry)  
Chariot à plateaux multi-standards (Gastronorm / Euronorm / Pâtisserie)

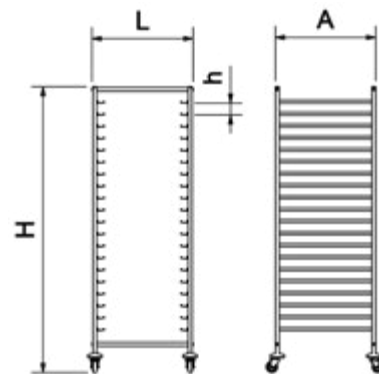

L	A	H	h	🔧	Kg	📊	€
666	661	1.888	78	20	27	076030	<b>960,00</b>



Rueda anticalórica con freno en acero inoxidable ø100 mm   
Heat resistant swivel wheel with brake in stainless steel ø100 mm  
Roulette résistante à la chaleur avec frein en acier inoxydable ø100 mm

175 Kg. -40 a 280°C 840 485026 **70,00**



Rueda anticalórica en acero inoxidable ø100 mm   
Heat resistant swivel wheel in stainless steel ø100 mm  
Roulette résistante à la chaleur en acier inoxydable ø100 mm

175 Kg. -40 a 280°C 840 485028 **55,00**

## Funda reutilizable para carro de pastelería Euronorm

Reusable cover for Euronorm pastry trolley  
Housse réutilisable pour chariot à pâtisserie Euronorm



L	A	H	Kg	Barcode	€
495	700	1.700	1	476006	<b>252,00</b>

## Caja de 50 fundas desechables para carro de Euronorm / Gastronorm

Box of 50 disposable covers for Euronorm / Gastronorm trolley  
Boîte de 50 housses jetables pour chariot Euronorm / Gastronorm



L	A	H	Kg	Barcode	€
400	600	1.800	1	476008	<b>111,00</b>

## Carro de transporte

Platform trolley  
Chariot à plate-forme



### Características:

Acabado en cincado electrolítico.  
2 ruedas giratorias y 2 fijas.

### Characteristics:

Electrolytic zinc finishing.  
2 swivel wheels and 2 fixed wheels.

### Caractéristiques:

Finition en zinc électrolytique.  
2 roues pivotantes et 2 roues fixes.

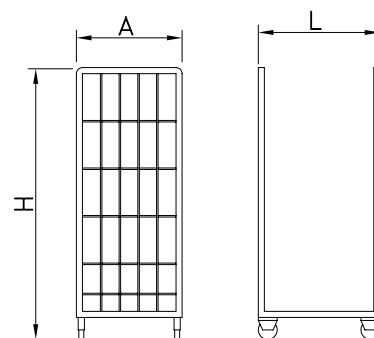

L	A	H	Kg	Kg	Barcode	€
700	800	1.800	600	22	476002	<b>237,00</b>

## Carro de plataforma inox con asa retráctil

Platform stainless steel trolley with retractable handle  
Chariot à plateforme inox avec poignée rétractable

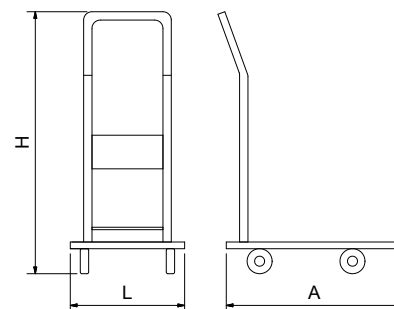
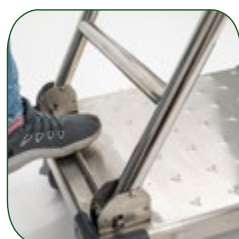

L	A	H	Kg	Kg	Barcode	€
490	760	840	300	9,4	480252	<b>249,00</b>

## Palet para jamones

Palet for cured hams

Palette pour jambons



Los precios de los crochets del código 022702. El cliente puede regular la altura de colocación de los tubos en cada nivel. Posibilidad de añadir tubos adicionales. Se pueden montar 2 palets.

Desmontable.  
Máxima capacidad de carga por palet: 300 Kgs. Uniformemente repartidos entre todos los niveles y en el nivel.  
Máxima capacidad de carga por palet remontando: 150 Kgs. Uniformemente repartidos entre los dos palets, entre todos los niveles y en cada nivel.  
Se puede manejar con transpaleta.  
Construido en acero galvanizado.  
Posibilidad de acoplar ruedas.

496



Ruedas  
Wheels  
Rouelles



### Characteristics:

3 levels.  
1st and 3rd levels: 4 tubes.  
2nd level: 3 tubes.  
Total: 11 tubes and 55 crochets 022702.  
The customer has the possibility of adjusting the height of the levels and placing the tubes on each level.  
Possibility of adding additional tubes.  
Stackable up to 2 pallets.  
Easy to move.  
Detachable.  
Maximum load strength, non-stacked: 300 kgs evenly distributed on each level.  
Maximum load strength, stacked: 150 kgs evenly distributed on each level.  
It can be transported with a forklift.  
Made in Galvanized steel.  
Possibility of wheels assembly.

### Caractéristiques:

Elle a 3 niveaux.  
1<sup>er</sup> et 3<sup>e</sup> niveau: 4 tubes.  
2<sup>e</sup> niveau: 3 tubes.  
Total: 11 tubes et 55 crochets 022702.  
Possibilité de régler la hauteur des niveaux et l'emplacement des tubes à chaque niveau.  
Possibilité d'ajouter des tubes supplémentaires.  
Remontable-Maximum 2 palettes.  
Transport facile.  
Démontable.  
Capacité max de charge par palette: 300 Kgs. Uniformément répartis entre tous les niveaux et sur le niveau.  
Capacité max de charge par palette remontante: 150 Kgs. Uniformément répartis entre tous les niveaux et sur le niveau.  
On peut la manipuler avec transpalette.  
Fabriquée en acier galvanisé.  
On peut ajouter des rouelles.

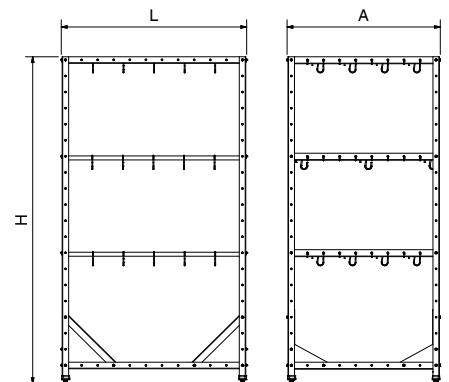

L A H Kg €

1.153 953 2.033 46 076040 596,00



## Palet para embutidos

Pallet for sausages and cured meat  
Séchoir charcuterie démontable en palette



496

Ruedas  
Wheels  
Rouelles



### Características:

4 niveles y 6 tubos por nivel.  
Regulación en altura de los niveles y tubos.  
Posibilidad de añadir tubos adicionales.  
Remontable. Máximo 2 palets.  
Fácil transporte.  
Desmontable.  
Máxima capacidad de carga por palet: 300 KGS. Uniformemente repartidos entre todos los niveles y en el nivel.  
Máxima capacidad de carga por palet remontando: 150 KGS Uniformemente repartidos entre los dos palets, entre todos los niveles y en cada nivel.  
Se puede manejar con transpaleta.  
Construido en acero galvanizado.

### Characteristics:

4 levels and 6 tubes per level.  
The levels and tubes can be adjusted.  
Possibility of mounting additional elements.  
Stackable up to 2 pallets.  
Easy to transport.  
Detachable.  
Maximum load strength, non-stacked: 300 kg per pallet, evenly distributed on each level.  
Maximum load strength, stacked: 150 kg per pallet, evenly distributed on each level.  
Can be transported with a forklift.  
Made in galvanized steel.

### Caractéristiques:

Il a 4 niveaux.  
6 tubes par niveau, total 24 tubes.  
Possibilité de régler la hauteur des niveaux par le client et possibilité de choisir l'emplacement des tubes dans chaque niveau.  
Possibilité d'ajouter des tubes additionnels.  
Possibilité d'empiler. Maximum 2 palettes.  
Transport facile.  
Démontable.  
Capacité maximale de charge par palette: 300 kg uniformément repartis.  
Capacité maximale de charge par palette remontée: 150 kg uniformément repartis.  
On peut le transporter avec transpalette.  
Fabriqué en acier galvanisé.

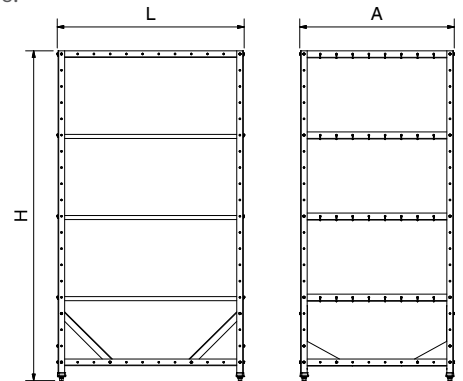

L	A	H	Kg	Barcode	€
1.153	953	2.033	55	076050	619,00

## Carro para canales

Carcass trolley  
Chariot à carcasses



### Características:

4 ruedas giratorias.  
Estante inferior móvil.  
Estructura del tubo 40x40 mm.

### Characteristics:

4 swivel wheels.  
Detachable lower level.  
Tube 40x40 mm.

### Caractéristiques:

4 roues pivotantes.  
Niveau inférieur amovible.  
Tube 40x40 mm.



**\*HASTA 500 Kg**  
Up to 500 kgs  
Jusqu'à 500 kgs

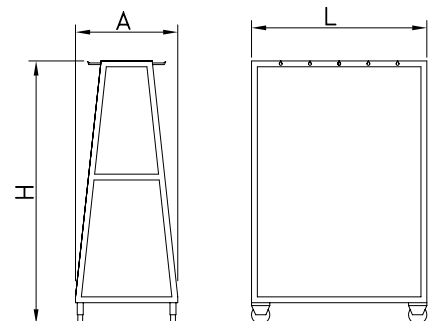

L	A	H	Kg	Barcode	€
1.200	700	1.800	38	476030	1.784,00



## Mostrador de pescadería con soporte

Floor-mounted fish counter  
Étal à poisson avec support



Tacos regulables  
Protector frontal curvado transparente  
Laterales transparentes  
Bandejas perforadas  
Desagües  
Conectores rápidos desagües  
Mangueras desagües  
Puertas desmontables  
Juego de adhesivos ola para los frentes

Adjustable blocks  
Front and sides  
of plastic  
Perforated trays  
Drainers  
Quick connectors  
hoses  
Drains hoses  
Rear detachable  
doors  
Set of decorative  
stickers "Wave"

Taquets réglables  
Front et flancs en  
plastique  
Plateaux perforés  
Déversoirs  
Connecteurs  
rapide pour tuyaus  
Tuyaus déversoirs  
Portes postérieures  
amovibles  
Jeu d'autocollants  
décoratives

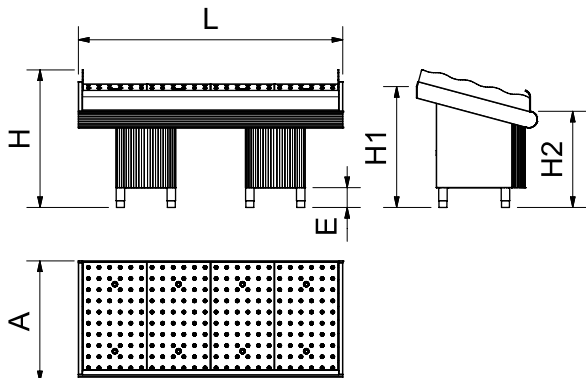

## Características:

Fabricado totalmente con acero inoxidable AISI 304, está diseñado para adaptarse a las necesidades de los diferentes establecimientos.

## Characteristics:

Wholly made of stainless steel AISI 304, it has been designed to meet the needs of any establishment.

## Caractéristiques:

Fabriqué totalement en acier inoxydable AISI 304, c'est conçu pour subvenir les besoins de tous les établissements.

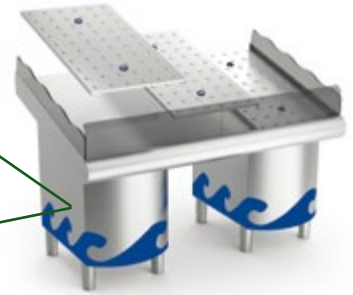

Mediante un novedoso sistema de bandejas conseguimos que el hielo permanezca sujeto a la exposición, evitando su desplazamiento hacia la parte delantera. A diferencia de otros expositores, con nuestro diseño ahorraremos energía y agua, pues con una capa menor de hielo conseguiremos exponer mejor el producto.

By means of a new trays system we achieve the ice to remain fixed to the counter system and we avoid it to slide to the front side. Unlike other counters, with this new system we will save both water and energy, since with a thinner sheet of ice you will be able to exhibit your products in the best conditions.

Grâce à un nouveau système de plateaux nous atteindrons que le glace reste fixé au comptoir et nous évitons qu'elle se glisse vers la partie inférieure. Contrairement à autres étals, avec ce système vous épargnez de l'eau et de l'énergie, puisque avec une couche de glace plus fine vous pourrez exposer vos produits dans les meilleures conditions.



Mediante la regulación de los pies podemos incrementar la altura hasta 50 mm más.

By the adjustment of the legs you can increase the height up to 50 mm.

Par le réglage des pieds vous pouvez incrémenter l'hauteur jusqu'à 50 mm.

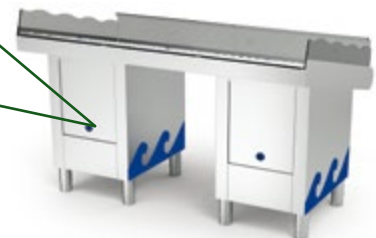

L	A	H	H1	H2	E	kg	Barcode	€
985	950	1.045	960	730	150	1	51 074439	<b>1.450,00</b>
1.465	950	1.045	960	730	150	2	78 074445	<b>2.048,00</b>
1.950	950	1.045	960	730	150	2	116 074440	<b>2.400,00</b>
2.912	950	1.045	960	730	150	2	120 074444	<b>3.200,00</b>

Optional / Optional / Optionnel

## Mostrador de pescadería

Fish counter  
Étal à poisson



### Características:

Fabricado totalmente con acero inoxidable AISI 304, está diseñado para adaptarse a las necesidades de los diferentes establecimientos.

### Characteristics:

Wholly made of stainless steel AISI 304, it has been designed to meet the needs of any establishment.

### Caractéristiques:

Fabriqué totalement en acier inoxydable AISI 304, c'est conçu pour subvenir les besoins de tous les établissements.

Mediante un novedoso sistema de bandejas conseguimos que el hielo permanezca sujeto a la exposición evitando su desplazamiento a la parte delantera. A diferencia de otros exposidores con nuestro diseño ahorraremos energía y agua pues con una capa menor de hielo conseguiremos exponer mejor el producto.

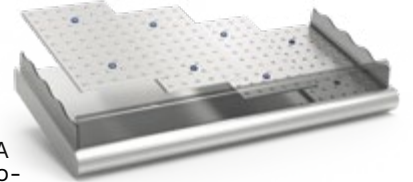

By means of a new trays system we achieve the ice to remain fixed to the counter and we avoid it to slide to the front side. Unlike other counters, with this new system we will save both water and energy, since with a thinner sheet of ice you will be able to exhibit your products in the best conditions.

Grâce à un nouveau système de plateaux nous atteindrons que le glace reste fixe au comptoir et nous évitons qu'elle se glisse vers la partie inférieure. Contrairement à autres étals, avec ce système vous épargnez de l'eau et de l'énergie, puisque avec une couche de glace plus fine vous pourrez exposer vos produits dans les meilleures conditions.

Protector frontal curvado transparente  
Laterales transparentes  
Bandejas perforadas pescaderías  
Desagües  
Mangueras desagües

Front et flancs en plastique  
Plateaux perforés  
Déversoirs  
Tuyaus déversoirs

Front and sides in plastic  
Perforated trays  
Drainers  
Drain hoses

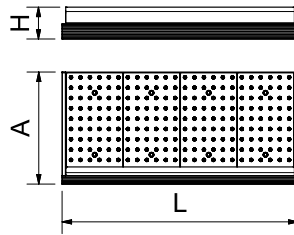

L	A	H	Kg	Barcode	€
985	950	270	25	074441	<b>850,00</b>
1.465	950	270	33	074447	<b>1.208,00</b>
1.950	950	270	48	074442	<b>1.350,00</b>
2.912	950	270	70	074446	<b>2.150,00</b>

## Prolongación modular para mostrador de pescadería

Modular extension for fish counter  
Extension modulaire pour étal à poisson



**Contenido:**  
Tacos regulables  
Laterales transparentes  
Dos bandejas perforadas

**Included:**  
Adjustable feet  
Transparent sides  
Two perforated trays

**Inclus:**  
Pieds réglables  
Côtés transparents  
Deux plateaux perforés



### Características:

Con esta ampliación modular del mostrador podrá duplicar la zona de exposición en la zona que más le interese. Desmontable, movable y regulable en altura.

### Characteristics:

This modular extension will allow you make double your display space at the required area. It is detachable, movable and with adjustable height.

### Caractéristiques:

Cette extension modulaire vous permettra doubler votre espace d'exposition à la zone nécessaire. Elle est amovible, mobile et réglable en hauteur.

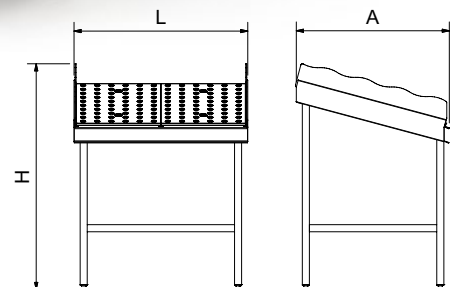

L	A	H	Kg	Barcode	€
985	867	1.279	29,5	074462	<b>990,00</b>



074444 3.200,00 328



Mostrador de pescadería con soporte  
Floor-mounted fish counter  
Étal à poisson avec support



074462 990,00 329



Prolongación modular para mostrador de pescadería  
Modular extension for fish counter  
Extension modulaire pour étal à poisson

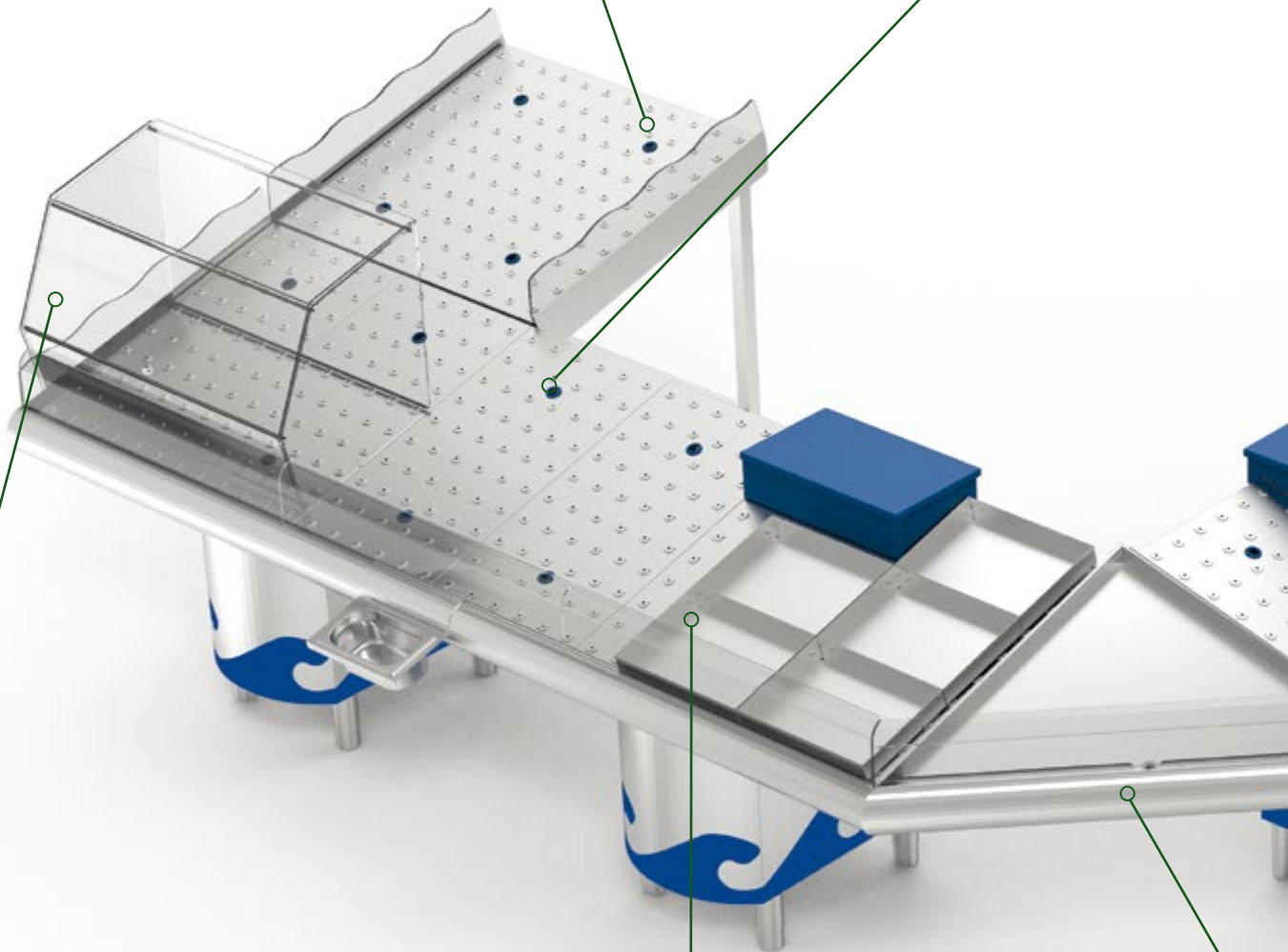

Cubierta protectora para mostrador de pescadería  
Sneeze screen for fish counter  
Vitre de protection pour étal à poisson

L	A	H	Kg		€
960	500	572	4,80	074464	353,00

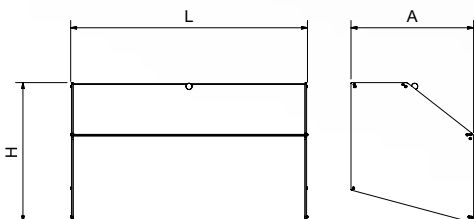
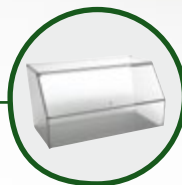

083420 39,00 452



Bandeja para marisco  
Seafood tray  
Plateau inox pour fruits de mer

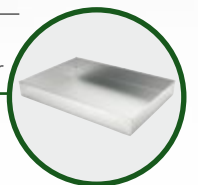



074460



190,00



336

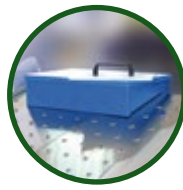

Tajo-expositor para mostrador de pescadería  
Polyethylene cutting board-display for fish counter  
Plaque de découpe-exposant en polyéthylène pour étal à poisson

Unión en escuadra interior para mostradores de pescadería  
Fish counter interior corner link  
Jonction d'angle interne pour étal à poisson

L	A	H	Kg	Barcode	€
1.230	870	118	8,00	074449	368,00

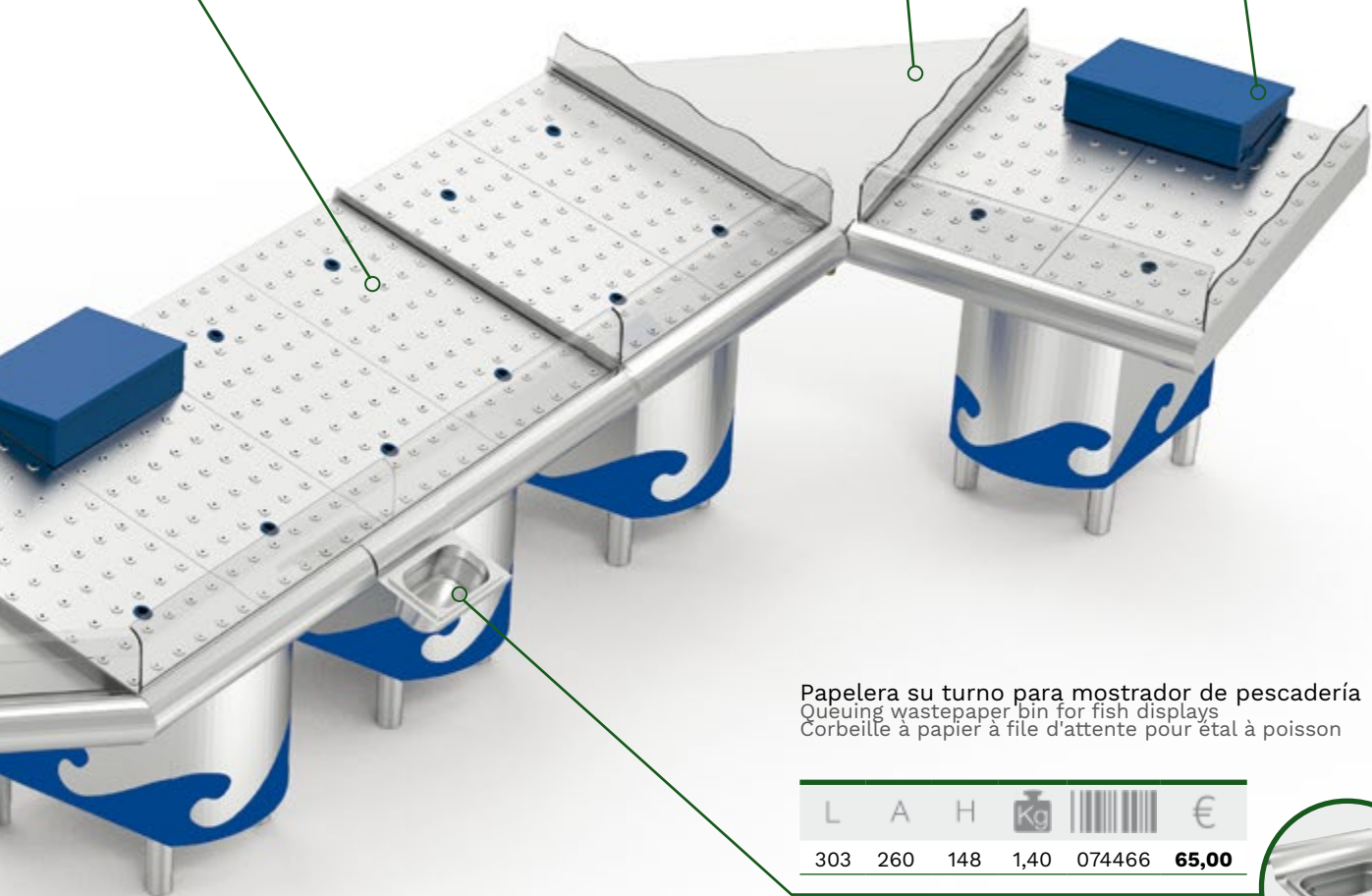
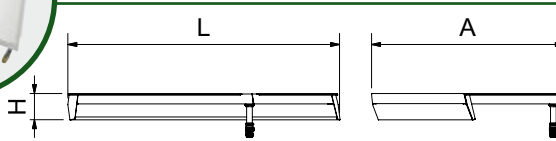
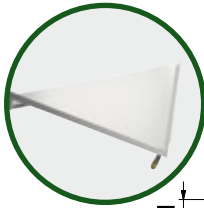

Papelera su turno para mostrador de pescadería  
Queuing wastepaper bin for fish displays  
Corbeille à papier à file d'attente pour étal à poisson

L	A	H	Kg	Barcode	€
303	260	148	1,40	074466	65,00

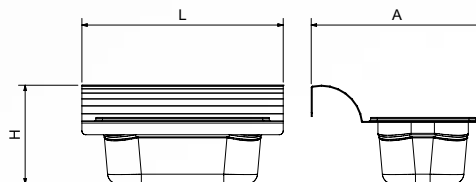

Unión en escuadra exterior  
Fish counter exterior corner link  
Jonction d'angle pour étal à poisson



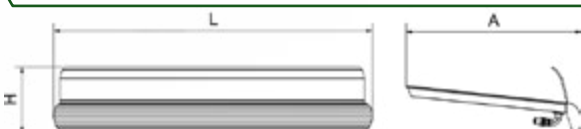
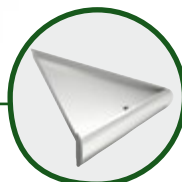





L	A	H	Kg	Barcode	€
1.290	960	256	11,00	074448	546,00

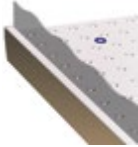
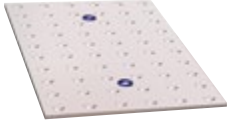

## Repuestos para mostradores de pescadería

Spares parts for fish counter

Rechanges pour étals à poisson

			Gr	€
	Frontal curvado transparente de 963 mm. Curved transparent front panel 963 mm. Panel courbe transparent 963 mm.	550	274490	<b>71,00</b>
	Lateral transparente Transparent side panel Panel latéral	410	374460	<b>34,00</b>
	Bandeja perforada para mostrador de pescadería Perforated tray for fish counter Plateau perforé pour comptoir à poisson	3.000	274476	<b>80,00</b>
	Pie regulable inox de Ø 63,5x150 mm. Adjustable stainless foot ø63,5x150 mm. Pied réglable inoxydable ø63,5x150 mm.	200	409856	<b>10,00</b>
	Adhesivo modelo "Ola" "Wave" model sticker Autocollant modèle "vague"	80	474468	<b>30,00</b>
	Adhesivo hierba. Sticker "Grass". Adhésif gazon.	90	474466	<b>30,00</b>
	Desagüe de poliamida blanca 3/4" L=90 mm. White polyamide drain 3/4" L=90 mm. Déversoir en polyamide 3/4" L=90 mm.	90	474460	<b>2,50</b>
	Abrazadera sin fin de 25-40 mm. para manguera Worm drive hose clamp 25-40 mm. Collier de serrage sans fin de 25-40 mm pour tuyau	5	460453	<b>1,30</b>
	Manguera flexible de 1" Flexible hose 1" Tuyau flexible 1"		474478	<b>4,00</b>
	Pasacable azul Ø 36x2,5 mm. Blue passcable Ø 36x2,5 mm. Passecâble bleu Ø 36x2,5 mm.	0,006	409830	<b>0,79</b>

## Mesas de preparación y lavado

Preparation and cleansing tables  
Tables de préparation et de lavage



**Dotación y características de fabricación:**  
Totalmente construida con acero inoxidable.  
Fibra de polietileno calidad P-500.  
Fregadero soldado con válvula, tapón y rebosadero.  
Tolva de evacuación de desperdicios.

**Features and manufacturing characteristics:**  
Fully made of stainless steel.  
P-500 quality polyethylene cutting board.  
Welded bowl with valve, plug and overflow.  
Hole for waste-chutes

**Dotation et caractéristiques de fabrication:**  
Entièrement fabriquées en acier inoxydable.  
Plaque découpe de polyéthylène qualité P-500.  
Bac soudée avec valve, déversoir.  
Trou pour tremie à déchets.



**Repuestos de fibras.**  
Spare cutting boards.  
Plaques de découpe.



78

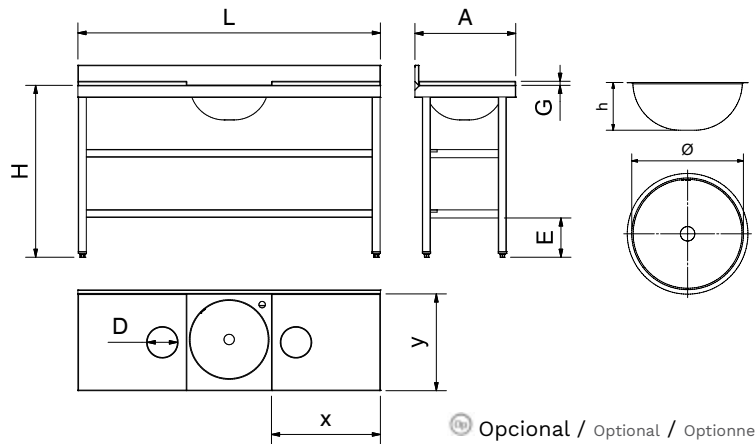

Ⓜ Opcional / Optional / Optionnel

	L	A	H	E	Ø	h	X	y	G	D	Kg	€
	1.000	500	850	200	390	170	540	480	20	150	23,5	072802 072880 <b>839,00</b> 072852
	1.000	500	850	200	390	170	540	480	20	150	23,5	072810 072882 <b>839,00</b> 072860
	1.500	500	850	200	390	170	540	480	20	150	30,0	072812 072884 <b>1.036,00</b> 072862
	1.500	500	850	200	390	170	540	480	20	150	30,0	072820 072886 <b>1.036,00</b> 072870
	1.500	500	850	200	390	170	540	480	20	150	34,0	072822 072888 <b>1.176,00</b> 072872

## Puesto pescadero encimera polietileno

Fish preparation table with polyethylene worktop  
Table de preparation de poisson dessus en polyéthylène



### Características:

Su peto trasero en plástico permite trabajar cómodamente de cara al público y evitar salpicaduras. El precio incluye el portacuchillos para adosar con envolvente.

### Characteristics:

Plastic back fringe that allows to work conveniently face to the public and to avoid splashing. Provided with a mounted knife holder with housing.

### Caractéristiques:

Pan coupé postérieur en plastique qui permet travailler commodément face au public et éviter des éclaboussures. Pourvu avec porte-couteaux pour adosar avec enveloppant.

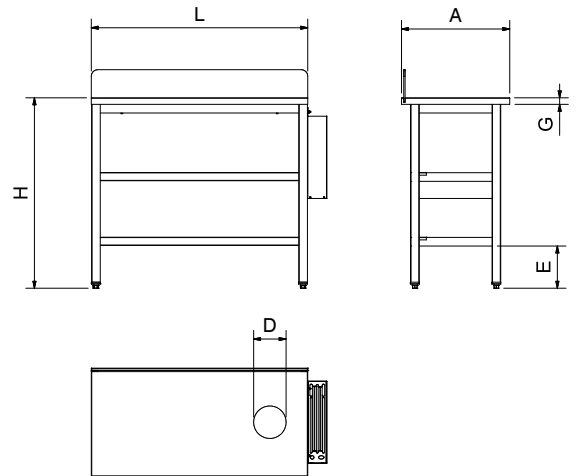

L	A	H	D	G	E	Kg	€
1.000	500	850	150	30	200	20	074424 <b>600,00</b>



Repuestos de fibras.  
Spare cutting boards.  
Plaques de découpe.



78

## Puesto pescadero modelo sencillo

Fish preparation table simple model  
Table de préparation de poisson modèle simple

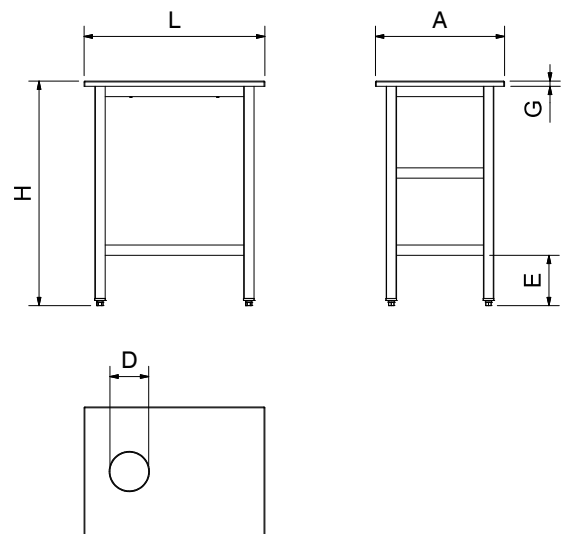

L	A	H	D	G	E	Kg	€
700	500	850	150	20	200	18	074404 074407 <b>384,00</b> 074406



Repuestos de fibras.  
Spare cutting boards.  
Plaques de découpe.



78



## Mesa para marisco

Seafood table

Table pour fruits de la mer



074451 31,00

Separador para mesa de marisco

Separator for seafood table

Séparateur pour table pour fruits de la mer

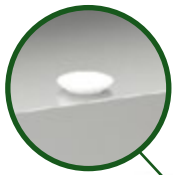
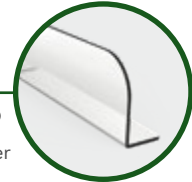

Ⓞ Opcional / Optional / Optionnel

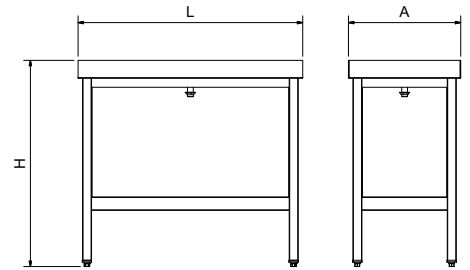

L	A	H	Kg	Barcode	€
1.000	500	917	27,2	074450	<b>797,00</b>

## Mesa para cocción de marisco

Seafood boiling and cooling table

Table de cuisson pour fruits de mer



### Características:

Cubeta GN 1/1 de 150 mm de profundidad con desagüe de vaciado incorporado.

Guías para desplazamiento de cubeta.

Ducha horno 463004.

### Characteristics:

GN 1/1 container 150 mm depth, with built-in outlet drain.

Guides for the motion of the container.

Shower for oven 463004.

### Caractéristiques:

Bac GN 1/1 de 150 mm de profondeur avec vidange.

Guides pour déplacement du bac.

Douchette four 463004.

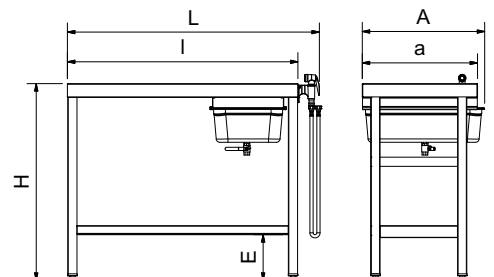

L	I	A	a	H	E	Kg	Barcode	€
1.095	1.000	530	500	850	200	29,67	074802	<b>769,00</b>

### Tajo-expositor para mostrador de pescadería

Polyethylene cutting board-display for fish counter  
Plaque de découpe-exposant en polyéthylène pour étal à poisson

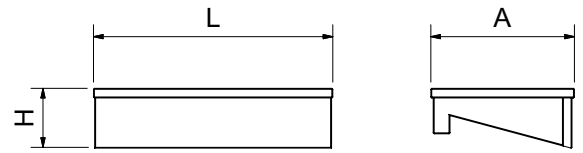
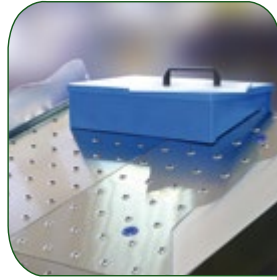

L	A	H	Kg	Barcode	€
500	300	125	4,70	074460	<b>190,00</b>

### Paleta de fibra para aplastar hielo

Polyethylene trowel for crushing ice  
Truelle en polyéthylène pour piler la glace

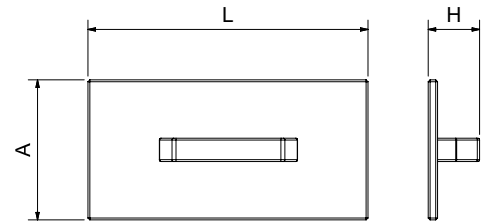

L	A	H	Gr	Barcode	€
300	150	55	500	032202	<b>33,00</b>

### Pala para hielo

Ice spade  
Pelle à glaçons



#### Características:

Su fabricación en polipropileno garantiza:  
No absorbe agua.  
No pierde su dureza en condiciones de humedad.  
Puede ser esterilizado (no en autoclave).  
Soporta temperaturas de hasta 100°C.

#### Characteristics:

It is made of polypropylene, which guarantees:  
No water absorption.  
No loss of hardness in humidity conditions.  
Possibility of sterilization.  
It resists temperatures up to 100°C.

#### Caractéristiques:

Sa fabrication en polypropylène garantit:  
Pas d'absorption d'eau.  
Pas de perte de dureté dans conditions d'humidité.  
Possibilité de stérilisation.  
Supporte température jusqu'à 100°C.

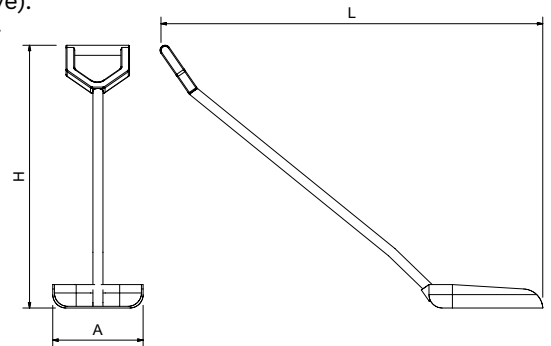

L	A	H	Kg	Barcode	€
1.107	279	890	1,5	474458	<b>93,00</b>

### Pala de mano para hielo

Ice shovel  
Pelle à glaçons



#### Characteristics:

It is made of polypropylene, which guarantees:  
No water absorption.  
No loss of hardness in humidity conditions.  
Possibility of sterilization.  
It resists temperatures up to 100°C.

#### Caractéristiques:

Sa fabrication en polypropylène garantit:  
Pas d'absorption d'eau.  
Pas de perte de dureté dans conditions d'humidité.  
Possibilité de stérilisation.  
Supporte température jusqu'à 100°C.

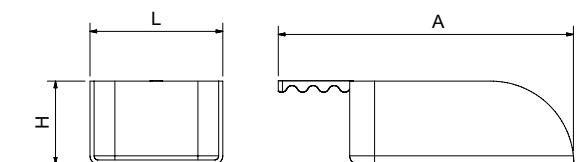

L	A	H	Gr	Barcode	€
160	340	90	150	474456	<b>12,00</b>

## Expositor de frutas y verduras inox con ruedas

Stainless steel fruit and vegetable display rack with wheels

Présentoir de fruits et légumes en acier inoxydable avec roulettes



Fabricado en acero inoxidable AISI 304 este expositor de frutas y verduras es ideal para cualquier frutería o supermercado, gracias a que se trata de una solución modular, escalable, resistente y duradera.

El expositor está diseñado para colocar dos cestas alimentarias estándar de 600x400 mm apoyadas sobre sus pestañas interiores. Sus frutas y verduras quedarán perfectamente expuestas gracias a esta solución.

Incorpora cuatro ruedas, dos de ellas con freno para facilitar que el expositor mantenga la posición deseada.

\* Este artículo se entrega desmontado. Incluye tornillería.

Made of AISI 304 stainless steel, this fruit and vegetable display is ideal for any greengrocer or supermarket, thanks to the fact that it is a modular, scalable, resistant and durable solution.

This display rack has been designed to lodge two standard 600x400 mm food baskets docked on their supporting brackets. Your fruits and vegetables will be perfectly displayed thanks to this solution. It is fitted with four wheels, two of them with brakes to make it easier for the display to keep the desired position.

\* This item is delivered disassembled. Screws included.



Fabricado en acero inoxidable AISI 304, este presentoir de fruits et légumes est idéal pour tout marchand de légumes ou supermarché, car il s'agit d'une solution modulaire, évolutive, résistante et durable.

Le présentoir est conçu pour placer deux paniers alimentaires standard de 600x400 mm reposant sur leurs languettes intérieures. Vos fruits et légumes seront parfaitement exposés grâce à cette solution.

Il intègre quatre roues, dont deux avec freins pour faciliter le maintien de la position souhaitée par l'exposant.

\* Cet article est livré démonté. Visserie incluse.

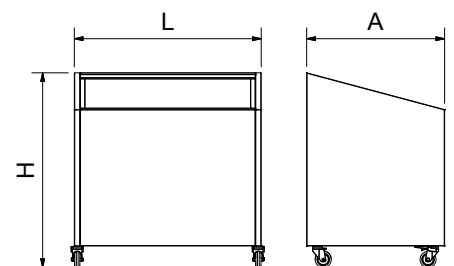
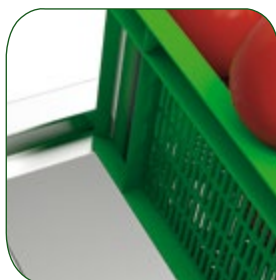

L	A	H	Kg	Barcode	€
864	638	900	18,5	075610	300,00

## Mostrador frutería

Floor-mounted vegetable counter  
Comptoir fruits et légumes



### Características:

Fabricado totalmente con acero inoxidable AISI 304, está diseñado para adaptarse a las necesidades de los diferentes establecimientos.

### Characteristics:

Wholly made of stainless steel AISI 304, it has been designed to meet the needs of any establishment.

### Caractéristiques:

Fabriqué totalement en acier inoxydable AISI 304, c'est conçu pour subvenir les besoins de tous les établissements.

Tacos regulables  
Desagües  
Mangueras desagües  
Puertas desmontables  
Juego de adhesivos hierba para los frentes

Adjustable blocks  
Drainers  
Drains hoses  
Rear detachable doors  
Set of decorative stickers "Hierba"

Taquets réglables  
Déversoirs  
Tuyaus déversoirs  
Portes postérieures amovibles  
Jeu d'autocollants décoratives

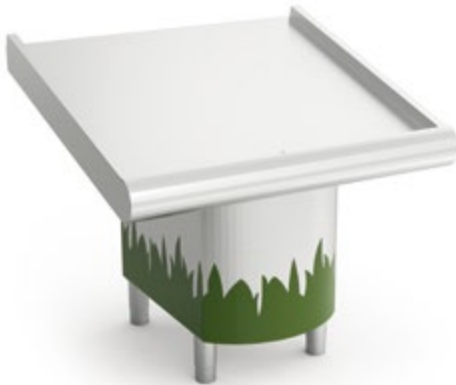

Mediante la regulación de los pies podemos incrementar la altura hasta 50 mm más.

By the adjustment of the legs you can increase the height up to 50 mm.

Par le réglage des pieds vous pouvez incrémenter l'hauteur jusqu'à 50 mm.

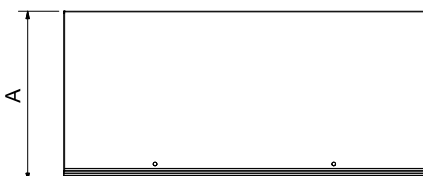
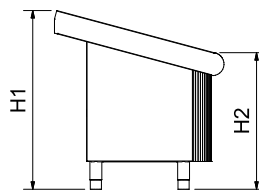
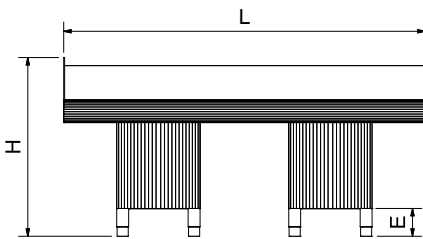

L	A	H	H1	H2	E		Kg		€
985	950	1.045	960	730	150	1	39,0	075630	<b>1.150,00</b>
1465	950	1.045	960	730	150	2	69,0	075632	<b>1.575,00</b>
1948	950	1.045	960	730	150	2	76,5	075634	<b>1.880,00</b>
2911	950	1.045	960	730	150	2	90,5	075636	<b>2.400,00</b>

Opcional / Optional / Optionnel

## Mostrador frutería sobre obra

Vegetable counter to be fitted on a built-in stand  
Comptoir fruits et légumes de chantier

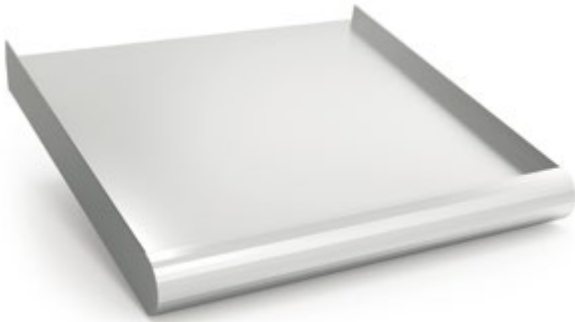

### Características:

Fabricado totalmente con acero inoxidable AISI 304, está diseñado para adaptarse a las necesidades de los diferentes establecimientos.

### Characteristics:

Wholly made of stainless steel AISI 304, it has been designed to meet the needs of any establishment.

### Caractéristiques:

Fabriqué totalement en acier inoxydable AISI 304, c'est conçu pour subvenir les besoins de tous les établissements.

Tacos regulables  
Desagües  
Mangueras desagües

Adjustable blocks  
Drainers  
Drains hoses

Taquets réglables  
Déversoirs  
Tuyaus déversoirs



L	A	H	Kg	Barcode	€
985	950	120	16	075620	<b>550,00</b>
1465	950	120	23	075622	<b>735,00</b>
1948	950	120	30	075624	<b>850,00</b>
2911	950	120	44	075626	<b>1.350,00</b>

## Separador para mostrador de frutería / pescadería

Divider for vegetable / fish counter  
Séparateur pour comptoir de Fruiterie /Poissonnerie

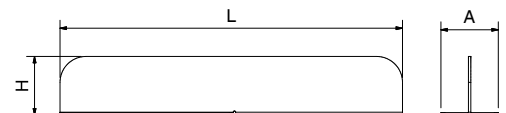
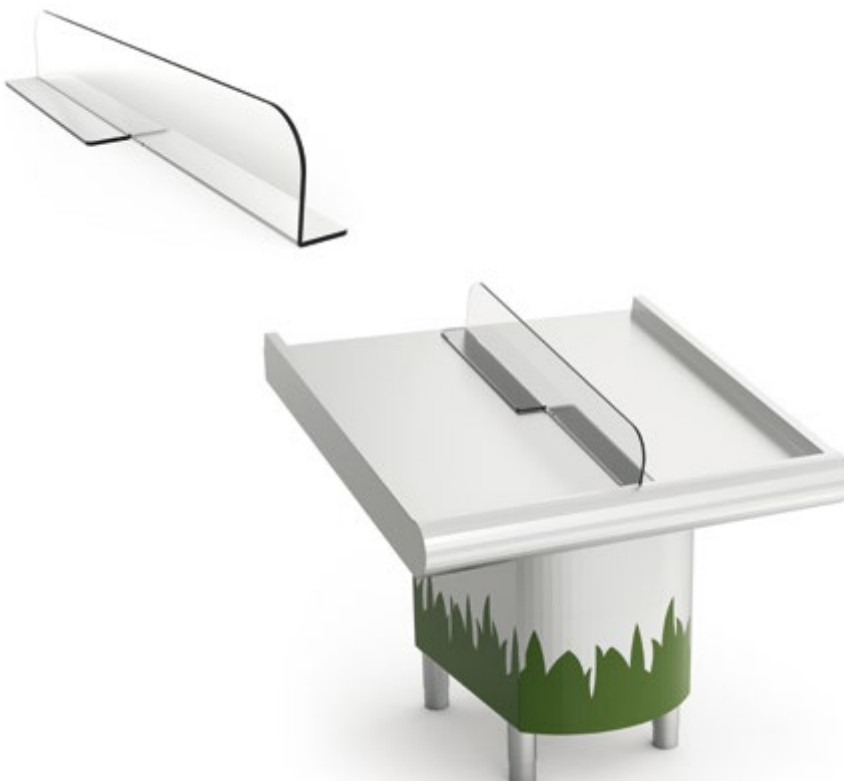

L	A	H	Kg	Barcode	€
860	144	147	1,7	075638	<b>88,00</b>



075636



2.400,00



338



**Mostrador frutería**  
Floor-mounted vegetable counter  
Comptoir fruits et légumes



074462



990,00



329



**Prolongación modular**  
Modular extension  
Extension modulaire



**Unión en escuadra exterior**  
Fish counter external corner link  
Jonction d'angle pour étal à poisson

L	A	H	Kg	Barcode	€
1.290	960	256	11,00	074448	<b>546,00</b>

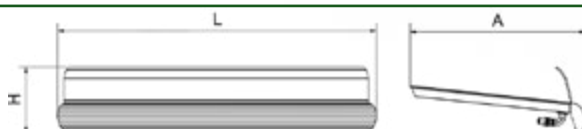
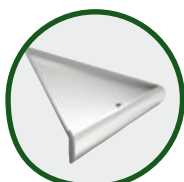



456

Cestas alimentarias  
Food baskets  
Paniers alimentaires



Unión en escuadra interior  
Interior corner link  
Jonction d'angle interne

L	A	H	Kg	Barcode	€
1.230	870	118	8,00	074449	<b>368,00</b>

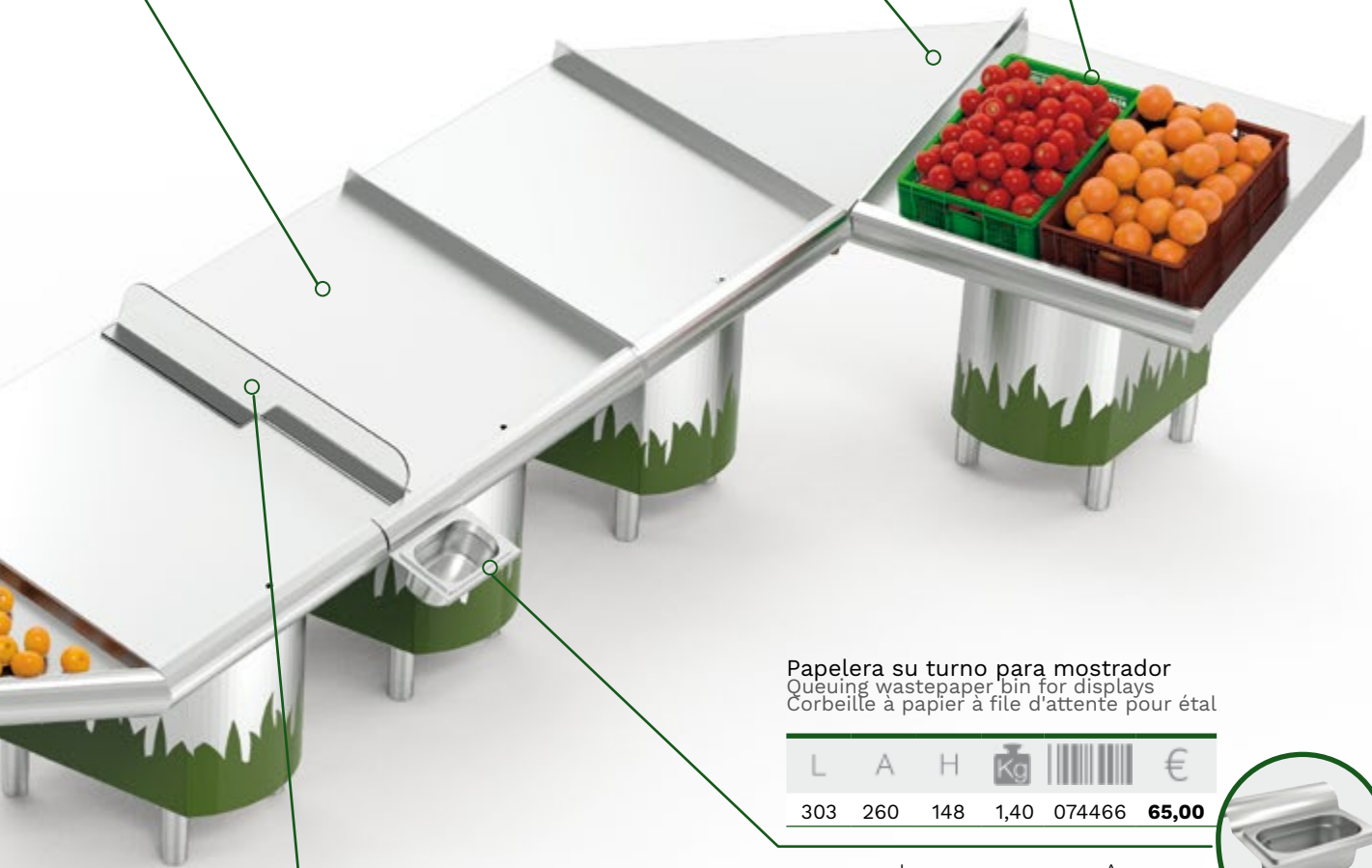
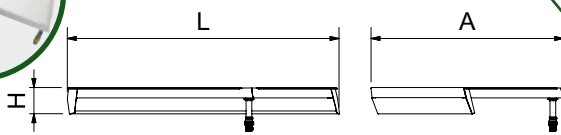
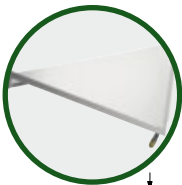

Papelera su turno para mostrador  
Queuing wastepaper bin for displays  
Corbeille à papier à file d'attente pour étal

L	A	H	Kg	Barcode	€
303	260	148	1,40	074466	<b>65,00</b>

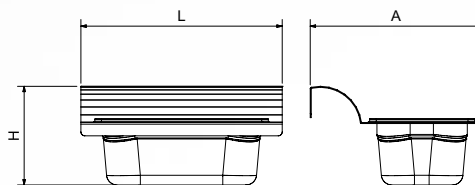

Barcode	€	Icon	Op
075638	88,00	339	

Separador para mostrador de frutería / pescadería  
Divider for vegetable / fish counter  
Séparateur pour comptoir de Fruiterie /Poissonnerie

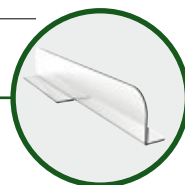

## Armarios de puertas correderas

Cupboards with sliding doors  
Armoires à portes coulissantes



### Características:

Fabricado totalmente con acero inoxidable.  
Laterales y trasera forrados de acero inoxidable.  
Entrepaña intermedio.  
Tiradores integrados en la puerta.  
Puertas colgadas, con lo que se evitan depósitos de suciedad en carriles y entrepaños.

### Characteristics:

Fully made of stainless steel.  
Back and sides covered with stainless steel panels. Centered shelf.  
The main advantage of our sliding doors tables consists on their hanging doors. They avoid dirtiness deposits in rails and shelves.  
Furthermore the handles are integrated in the sheet.

### Caractéristiques:

Fabriqué totalement en acier inoxydable.  
Latérales et retour recouvertes en acier inoxydable . Tablette-rayon centre.  
La principale avantage de nos tables à portes coulissantes c'est que ses portes sont suspendues pour éviter des dépôts de saleté dans les rails et dans les tablettes-rayons. En plus les poignées sont intégrées dans la plaque.



Vista de mesa y armario.  
Table and wardrobe view.  
Vue de table et armoire.

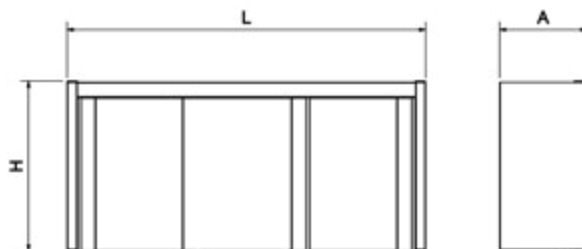

L	A	H		Kg		€
990	340	660	2	26,0	080806	<b>886,00</b>
1.390	340	660	3	36,0	080808	<b>1.063,00</b>
990	440	660	2	27,5	080802	<b>974,00</b>
1.390	440	660	3	36,0	080804	<b>1.169,00</b>

## Armarios de puertas abatibles

Cupboards with hinged doors  
Armoires à portes ouvrantes

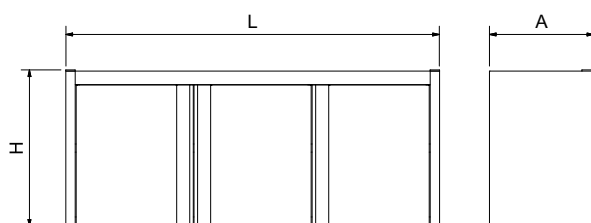

L	A	H		Kg		€
1.075	340	660	2	27	080810	<b>780,00</b>
1.575	340	660	3	42	080812	<b>1.094,00</b>
1.075	440	660	2	33	080814	<b>1.003,00</b>
1.575	440	660	3	48	080816	<b>1.202,00</b>



## Armario de esquina derecha con puertas abatibles

Right corner cabinet with hinged doors  
Armoire d'angle à droite avec portes ouvrantes

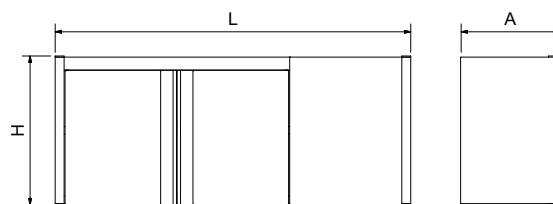

L	A	H		Kg		€
1.075	340	660	1	26	080820	<b>911,00</b>
1.575	340	660	2	41	080824	<b>1.094,00</b>
1.075	440	660	1	32	080828	<b>1.003,00</b>
1.575	440	660	2	47	080834	<b>1.190,00</b>

## Armario de esquina izquierda con puertas abatibles

Left corner cabinet with hinged doors  
Armoire d'angle à gauche avec portes ouvrantes

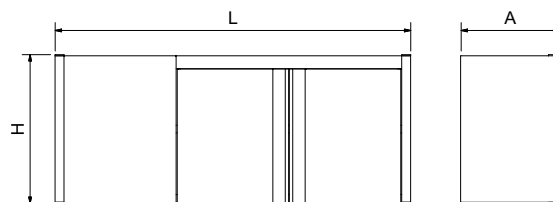

L	A	H		Kg		€
1.075	340	660	1	26	080818	<b>911,00</b>
1.575	340	660	2	41	080822	<b>1.094,00</b>
1.075	440	660	1	32	080826	<b>1.003,00</b>
1.575	440	660	2	47	080832	<b>1.190,00</b>



## Armario para productos de limpieza

Wardrobe for cleaning products  
Armoire pour produits d'entretien



### Características:

Fabricado totalmente con acero inoxidable. Como dotación estándar lleva tres estantes en el lado derecho para la colocación de trapos, productos de limpieza, etc. Además, su diseño permite guardar cubos, recipientes grandes, escobas, fregonas, etc. Construido totalmente en acero inoxidable, acabado satinado, dispone de techo inclinado y 4 patas en altura de 115 mm para poder limpiar debajo de él. Estas patas están situadas de tal manera que salvan la curva sanitaria en la pared. Pies regulables. Ventilación mediante respiraderos. Pomo con posibilidad de acoplar candado. Ver página 351.



081612 265,00



Opción de kit de ozono acoplado.  
Optional ozone kit, coupled  
kit ozone accouplé



Set colgador sujeta-palos.  
Handle-holder kit.  
Kit porte-manches.



473



Opcional / Optional / Optionnel



### Characteristics:

Fully made of stainless steel. As standard fitting it is equipped with three shelves on the right side for the storage of cloths, cleaning products, etc. Furthermore, it has been designed to lodge buckets, large containers, brooms, mops, etc. Wholly constructed of stainless steel with satin finish and sloping roof. Their feet are set back to bridge the wall sanitary curve and adjustable up to 115 mm, which will enable you clean underneath. Ventilation through hammered vents. Closing knob with the option of padlock. See page 351.

### Caractéristiques:

Fabriqué totalement en acier inoxydable. Comme équipement standard il a trois étagères dans une des côtes pour la placement des chiffons, produit d'entretien, etc. En plus, sa dessine permet garder seaux, récipients grands, balais, balais-serpillières, etc. Construit totalement en acier inoxydable, avec finition satiné, ils ont toit penché et empiètements de 115 mm d haut pour qu'on peut nettoyer dessous. Ces empiètements sont dessinées tellement qui sauvent la courbe sanitaire du mur et en même temps sont réglables. Aération par soupiraux emboutis et serrure. On peut placer un cadenas dans le bouton, voir page 351.

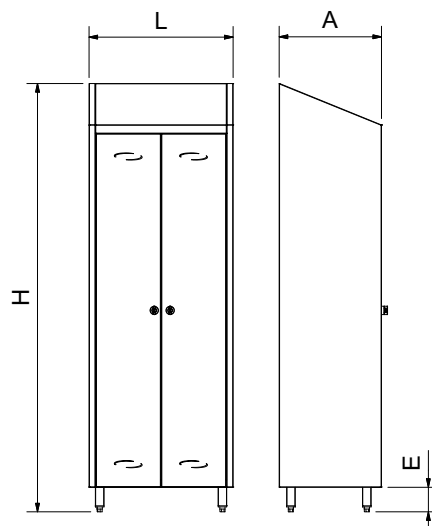

L	A	H	E		Kg		€
370	480	2.010	115	1	27	081412	<b>780,00</b>
680	480	2.010	115	2	45	081602	<b>974,00</b>



Consulten la posibilidad de acoplar un desinfectador-desodorizador por ozono en el armario.

Ask for the possibility of assembly a disinfectant-deodorant by ozone in the wardrobe  
Demandez-nous sur la possibilité de accoupler un désinfectant-désodorisant à l'ozone dans l'armoire

Posibilidad de acoplar ruedas ver pág 496

Possibility of assembly wheels, see page 496  
Possibilité d'accoupler rouelles, voir page 496

**Armario estantería 2 puertas**  
 2 doors shelving wardrobe  
 Armoire rayonnage de 2 portes



**\*HASTA 190 Kg**  
 Up to 190 kgs of load strength  
 Jusqu'à 190 kgs de résistance

**Características:**

Construido totalmente en acero inoxidable, acabado satinado, dispone de techo inclinado y 4 patas en altura de 115 mm para poder limpiar debajo de él. Estas patas están situadas de tal manera que salvan la curva sanitaria en la pared. Pies regulables. Ventilación mediante respiraderos embutidos. Pomo con posibilidad de colocar candado. Ver página 351.

**Characteristics:**

Wholly constructed of stainless steel with satin finish and sloping roof. Their feet are set back to bridge the wall sanitary curve and adjustable up to 115 mm, which will enable you clean underneath. Ventilation through hammered vents. Closing knob with the option of padlock. See page 351.

**Caractéristiques:**

Construit totalement en acier inoxydable, avec finition satiné, ils ont toit penché et empiètements de 115 mm d'hauf pour qu'on peut nettoyer dessous. Ces empiètements sont dessinées tellement qui sauvent la courbe sanitaire du mur et en même temps sont réglables. Aération par soupiraux emboutis et serrure. On peut placer un cadenas dans le bouton, voir page 351.



081612



265,00



Opción de kit de ozono acoplado.  
 Optional ozone kit, coupled  
 kit ozone accouple



**\*HASTA 500 Kg**  
 Up to 500 kgs of load strength  
 Jusqu'à 500 kgs de résistance



El pomo admite la colocación de candado.  
 Handle-holder kit.  
 Kit porte-manches.

351

Opcional / Optional / Optionnel

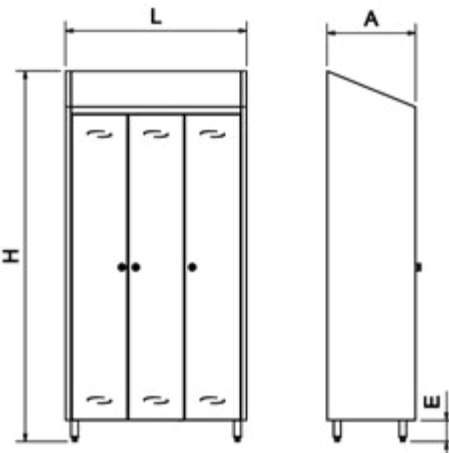

Posibilidad de acoplar ruedas ver pág 496  
 Possibility of assembly wheels, see page 496  
 Possibilité d'accoupler rouelles, voir page 496

L	A	H	E					€
680	480	2.010	115	2	190	55	081650	<b>1.065,00</b>
980	480	2.010	115	3	500	66	081652	<b>1.540,00</b>

## Armario / vitrina para hospitales y salas médicas

Cabinet / showcase for hospitals and medical rooms  
Armoire / vitrine pour hôpitaux et salles médicales



### Características:

Fabricado en acero inoxidable este armario dispone de puertas de amplia apertura dotadas de cerradura y paneles de PETG para permitir la visualización del interior.

Es ideal para el almacenaje seguro de material médico, instrumental o medicamentos.

Las patas incorporan tacos de plástico de alta resistencia ajustables en altura para adaptarse a cualquier estancia.

€ 59,00 351 Op

Cerradura de retorno de monedas  
Coin operated lock  
Serrure à monnaies



481405 € 8,50 351 Op

Cerradura maestra  
Master lock  
Serrure master



481402 € 4,10 351 Op

Llave maestra para cerraduras  
Master key for locks  
Clé passe-partout pour serrures



081612 € 265,00 Op

Opción de kit de ozono acoplado.  
Optional ozone kit coupled  
kit ozone accouple



€ 81,00 351 Op

Cerradura electrónica para taquilla  
Electronic lock for lockers  
Serrure électronique pour la porte vestiaire



### Characteristics:

Made of stainless steel, this cabinet has wide-opening doors formed by a lock and PETG sheets to view the interior.

It is ideal for a safe storage of medical material, instruments or medicines.

Its legs are provided with height-adjustable high-resistance plastic blocks to adapt to any floor unevenness.

### Caractéristiques:

Fabriquée en acier inoxydable, cette armoire est dotée de portes à large ouverture équipées d'une serrure et de panneaux en PETG pour permettre la visualisation de l'intérieur.

Il est idéal pour le stockage en toute sécurité de matériel médical, d'instruments ou de médicaments.

Les pieds intègrent des plots en plastique haute résistance réglables en hauteur pour s'adapter à n'importe quelle pièce.

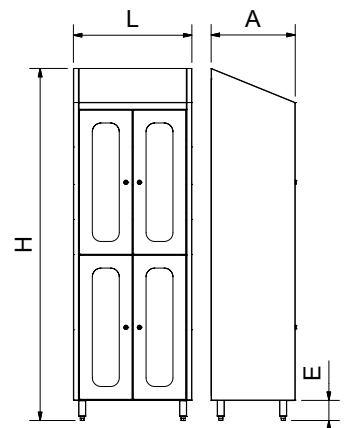

Posibilidad de acoplar ruedas ver pág 496  
Possibility of assembly wheels, see page 496  
Possibilité d'accoupler rouelles, voir page 496

L	A	H	E	Kg	Barcode	€
680	480	2.010	115	57	081620	1.100,00

## Armario para equipos informáticos

Wardrobe for computer equipment  
Cabinet pour matériel informatique



### Características:

Construido totalmente en acero inoxidable, acabado satinado, dispone de techo inclinado y 4 patas en altura de 115 mm para poder limpiar debajo de él. Estas patas están situadas de tal manera que salvan la curva sanitaria en la pared. Pies regulables. Ventilación mediante respiraderos embutidos. Pomo con posibilidad de colocar candado. Ver página 351.

### Characteristics:

Wholly constructed of stainless steel with satin finish and sloping roof. Their feet are set back to bridge the wall sanitary curve and adjustable up to 115 mm, which will enable you clean underneath. Ventilation through hammered vents. Closing knob with the option of padlock. See page 351.

### Caractéristiques:

Construit totalement en acier inoxydable, avec finition satiné, ils ont toit penché et empiètements de 115 mm d' haut pour qu' on peut nettoyer dessous. Ces empiètements sont dessinées tellement qui sauvent la courbe sanitaire du mur et en même temps sont réglables. Aération par soupiraux emboutis et serrure. On peut placer un cadenas dans le bouton, voir page 351.



El pomo admite la colocación de candado.  
Handle-holder kit.  
Kit porte-manches.



Op Opcional / Optional / Optionnel



Posibilidad de acoplar ruedas ver pág 496  
Possibility of assembly wheels, see page 496  
Possibilité d' accoupler rouelles, voir page 496

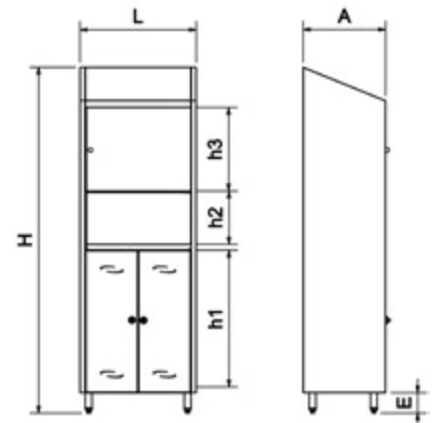

L	A	H	E	h1	h2	h3	Kg	Barcode	€
680	480	2.010	115	795	300	500	52	076402	1.314,00

## Atril de acero inoxidable

Stainless steel desk  
Pupitre en acier inoxydable



085480 200,00 494

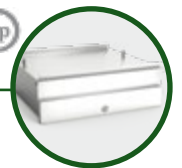

Cajón acoplado  
Drawer coupled  
Tiroir accouplé

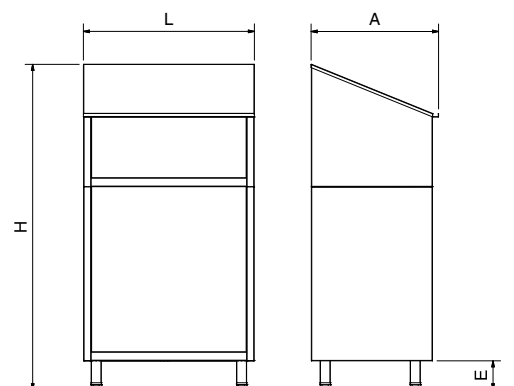

496  
Ruedas  
Wheels  
Rouelles

L	A	H	E	Kg	Barcode	€
678	505	1.290	115	22	074428	841,00

## Taquillas de 1, 2 y 3 puertas

1, 2 and 3 doors lockers

Armoire pour vestiaire de 1, 2 et 3 portes



### Características:

Construida totalmente en acero inoxidable, acabado satinado. Dispone de techo inclinado y patas en altura de 115 mm para poder limpiar debajo de ella. Estas patas están situadas de manera que salvan la curva sanitaria en la pared. Pies regulables. Ventilación mediante respiraderos embutidos. Cerraduras independientes. Cada cuerpo lleva un entrepaño superior, otro en la base y un perchero.

### Characteristics:

Wholly constructed of stainless steel with satin finish and sloping roof. Their feet are set back to bridge the wall sanitary curve and adjustable up to 115 mm, which will enable you clean underneath. Ventilation through hammered vents and individual locks. Every section has a lower shelf, an upper shelf and a clothes rack.

### Caractéristiques:

Fait totalement en acier inox, finition satiné, ils ont le toit incliné, pieds en hauteur de 115 mm. Pour pouvoir nettoyer par dessous d'eux, aussi ces pieds sont situés pour qu'ils sauvent la curve sanitaire dans le mur, pieds réglables, ventilation par soupirails encastrés, et fermeture indépendante. Chaque section a un évier supérieur et inférieur et un portemanteau.



€ 59,00 351

Cerradura de retorno de monedas  
Coin operated lock  
Serrure à monnaies



481405 8,50 351

Cerradura maestra  
Master lock  
Serrure master



481402 4,10 351

Llave maestra para cerraduras  
Master key for locks  
Clé passe-partout pour serrures



081612 265,00

Opción de kit de ozono acoplado.  
Optional ozone kit coupled  
kit ozone accouplé



€ 81,00 351

Cerradura electrónica para taquilla  
Electronic lock for lockers  
Serrure électronique pour la porte vestiaire

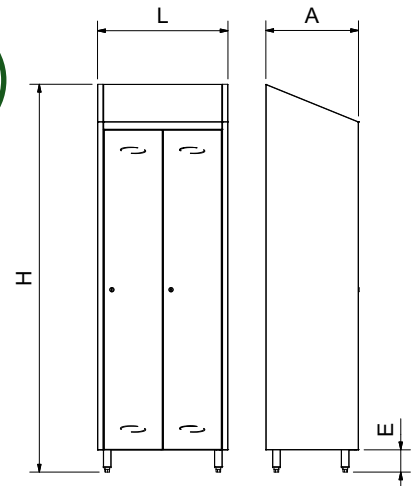

⚠ Contienen dos perchas inox por puerta.  
Two inox hangers for each door included.  
Deux cintres inox inclus par chaque porte.

⚠ Posibilidad de acoplar ruedas ver pág 497  
Possibility of assembly wheels, see page 497  
Possibilité d'accoupler rouelles, voir page 497

L	A	H	E		Kg	Barcode	€
370	480	2.010	115	1	27	081412	<b>795,00</b>
680	480	2.010	115	2	49	081406	<b>1.158,00</b>
985	480	2.010	115	3	62	081408	<b>1.552,00</b>

⚠ Consulten la posibilidad de acoplar un desinfectador-desodorizador por ozono en las taquillas.  
Ask for the possibility of assembly a disinfectant-deodorizant by ozone in the locker.  
Demandez-nous sur la possibilité de accoupler un désinfectant-désodorisant à l'ozone dans l'armoire.

## Taquillas de 2, 4 y 6 puertas

2, 4 and 6 doors lockers

Armoire pour vestiaire de 2, 4 et 6 portes

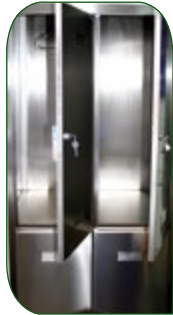

### Características:

Construida totalmente en acero inoxidable, acabado satinado. Dispone de techo inclinado y patas en altura de 115 mm para poder limpiar debajo de ella. Estas patas están situadas de manera que salvan la curva sanitaria en la pared. Pies regulables. Ventilación mediante respiraderos embutidos. Cerraduras independientes. Cada cuerpo lleva un entrepaño superior, otro en la base y un perchero.

### Characteristics:

Wholly constructed of stainless steel with satin finish and sloping roof. Their feet are set back to bridge the wall sanitary curve and adjustable up to 115 mm, which will enable you clean underneath. Ventilation through hammered vents and individual locks. Every section has a lower shelf, an upper shelf and a clothes rack.

### Caractéristiques:

Fait totalement en acier inox, finition satiné, ils ont le toit incliné, pieds en hauteur de 115 mm. Pour pouvoir nettoyer par dessous d'eux, aussi ces pieds sont situés pour qu'ils sauvent la curve sanitaire dans le mur, pieds réglables, ventilation par soupirails encastrés, et fermeture indépendant. Chaque section a un évier supérieur et inférieur et un portemanteau.



€ 59,00 351 Op

Cerradura de retorno de monedas  
Coin operated lock  
Serrure à monnaies



481402 € 4,10 351 Op

Llave maestra para cerraduras  
Master key for locks  
Clé passe-partout pour serrures



081612 € 265,00 Op 3

Opción de kit de ozono acoplado.  
Optional ozone kit, coupled  
kit ozone accouplé

€ 81,00 351 Op

Cerradura electrónica para taquilla  
Electronic lock for lockers  
Serrure électronique pour la porte  
vestiaire

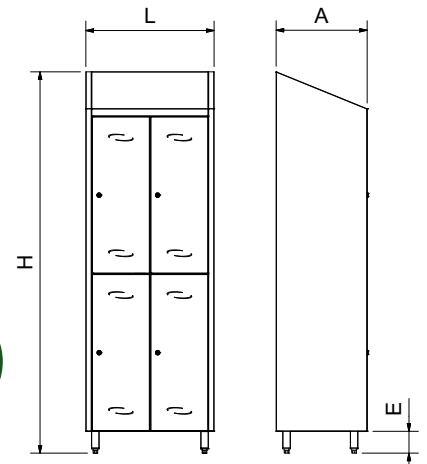

Contienen dos perchas  
inox por puerta.  
Two inox hangers for each  
door included.  
Deux cintres inox inclus par  
chaque porte.



Posibilidad de acoplar ruedas ver pág 497  
Possibility of assembly wheels, see page 497  
Possibilité d'accoupler rouelles, voir page 497

L	A	H	E		Kg		€
370	480	2.010	115	2	28	081410	<b>899,00</b>
680	480	2.010	115	4	50	081402	<b>1.280,00</b>
985	480	2.010	115	6	68	081404	<b>1.787,00</b>



Consulten la posibilidad de acoplar un desinfectador-desodorizador por ozono en las taquillas.  
Ask for the possibility of assembly a disinfectant-deodorizant by ozone in the locker.  
Demandez-nous sur la possibilité de accoupler un désinfectant-désodorisant à l'ozone dans l'armoire.

## Percha industrial de acero inoxidable

Stainless steel industrial hanger  
Cintre industrielle en acier inoxydable

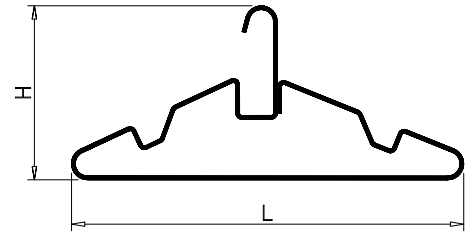

L	H	Gr	Barcode	€
420	190	120	081450	<b>11,00</b>

## Separadores para taquillas

Dividers for lockers  
Diviseur pour armoire vestiaire

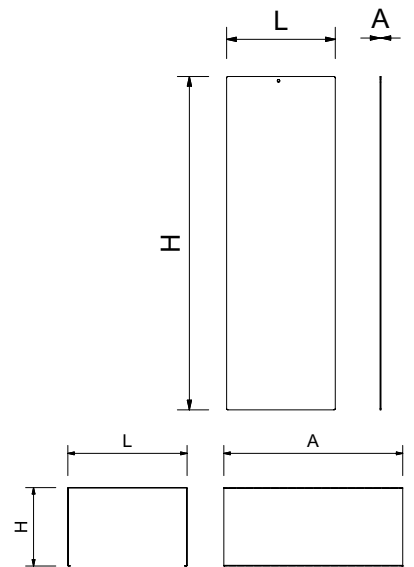

L	A	H	Kg	Barcode	€
450	3	1.180	0,80	081456	<b>25,00</b>
300	450	197	2,03	081458	<b>33,00</b>

## Banco de vestuario en acero inoxidable y polietileno

Changing room bench in stainless steel and polyethylene  
Banc de vestiaire en acier inoxydable et polyéthylène

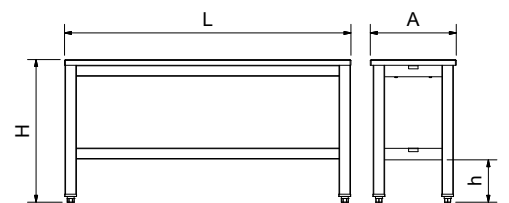













L	A	H	h	Kg	Barcode	€
1.000	300	500	150	10,00	084210	<b>185,00</b>
1.500	300	500	150	14,00	084212	<b>223,00</b>
2.000	300	500	150	18,00	084214	<b>298,00</b>





## Repuestos y complementos

Spare part and complements  
Rechange et compléments

		Gr	Barcode	€
	<b>Cerradura</b> Lock Serrure	41	481404	<b>5,50</b>
	<b>Cerradura maestra</b> Master lock Serrure master	41	481405	<b>8,50</b>
	<b>Llave maestra para cerraduras</b> Master key for locks Clé passe-partout pour serrures	10	481402	<b>4,10</b>
	<b>Juego de llaveros numerados del 1 al 6</b> Set of keyrings, numbered from 1 to 6 Ensemble de porte-cl-es numérotés de 1 à 6	30	481438	<b>3,00</b>
	<b>Juego de placas numeradas del 1 al 6</b> Set of plates, numbered from 1 to 6 Ensemble de plaques numérotées de 1 à 6	20	481439	<b>2,50</b>
	<b>Cerradura de retorno de monedas</b> Coin operated lock Serrure à monnaies	790	481410	<b>59,00</b>
			481412	
	<b>Montaje de la cerradura de retorno de monedas (no incluye cerradura)</b> Assembly coin operated lock (lock not included in this price) Assembler serrure à monnaies (serrure n'inclus pas dans ce prix)		081452	<b>34,00</b>
	<b>Cerradura con cadena para consigna de carros</b> Locker with chain for left-shopping trolleys Serrure avec chaîne pour consigne pour caddies	850	481430	<b>66,00</b>
	<b>Cerradura electrónica para taquilla</b> Electronic lock for lockers Serrure électronique pour la porte vestiaire	584	481418	<b>81,00</b>
			481419	
	<b>Montaje cerradura electrónica en puerta de taquilla (no incluye cerradura)</b> Installation of electronic lock for lockers (lock not included) Montage serrure électronique sur porte de vestiaire ( la serrure n'est pas incluse)		081454	<b>32,00</b>
	<b>Pomo articulado</b> Articulated handle Poignée articulée	80	481406	<b>13,00</b>
	<b>Candado para pomo articulado</b> Padlock for articulated handle Cadenas poignée articulée	105	481408	<b>23,00</b>
	<b>Taco regulable</b> Adjustable blocks Taquets réglables	45	409851	<b>1,50</b>
	<b>Taco regulable altura especial</b> Special height adjustable blocks Taquets réglables hayteur spéciale	115	409848	<b>3,00</b>
	<b>Tirador para puerta abatible</b> Handle for hinged door Poignet pour porte battante	80	474050	<b>6,30</b>





# SEGURIDAD E HIGIENE

## HEALTH AND CARE

### SÉCURITÉ ET SANTÉ AU TRAVAIL

#### NOVEDADES

NEWS  
NOUVEAUTÉS



358



361



361



364



368



378



390



400



403



404



407



408



410



412



412



423



424



424



## Guante de cinco dedos ambidiestro en malla de acero inoxidable

Reversible five finger stainless-steel mesh gloves  
Gants à cinq doigts réversibles en maille d'acier inoxydable



Guante fabricado en acero inoxidable. Antibacteriano para una higiene perfecta, reforzada gracias a su facilidad de limpieza. Mayor protección. Seguridad total, ya que carece de escotadura. Garantiza una protección total de la mano contra los cuchillos más afilados. Mayor confort de uso.

Talla Size Taille	XXS	XS	S	M	L
	≤72	73-78	79-83	84-88	≥89

Glove wholly made of stainless steel. Anti-bacteria glove for a perfect hygiene, reinforced thanks to its cleaning easiness. Higher protection. Total security, since it lacks low sleeve-line. It guarantees a total hand protection against the sharpest knives. Higher usage comfort.



Gant entièrement fabriqué en acier inoxydable. Gant anti-bactérienne pour une hygiène parfaite renforcée grâce à la facilité de sa nettoyage. Plus grande protection. Sécurité totale puisqu'il n'y a pas de échancrure. Il garantit une protection totale de la main contre les couteaux, même les plus aiguisés. Plus grande confort d'usage.

Talla Size Taille	Gr		€	Gr		€	Gr		€
			<b>EXPERT</b>						
XXS	130	448600	<b>80,00</b>	130	448610	<b>115,00</b>	200	448650	<b>125,00</b>
XS	140	448602	<b>80,00</b>	140	448612	<b>115,00</b>	235	448652	<b>125,00</b>
S	150	448604	<b>80,00</b>	150	448614	<b>115,00</b>	270	448654	<b>125,00</b>
M	170	448606	<b>80,00</b>	170	448616	<b>115,00</b>	305	448656	<b>125,00</b>
L	185	448608	<b>80,00</b>	185	448618	<b>115,00</b>	340	448658	<b>125,00</b>

## Tensor para guantes malla

Tensor for stainless-steel mesh gloves  
Tenseur des gants maille d'acier inoxydable



Talla Size Taille	Gr	€	Gr	€
Única Universal Unique	800	100	448620	<b>27,50</b>

**Delantal de protección en malla de acero inoxidable**  
 Stainless steel mesh protective apron  
 Tablier de protection en maille d'acier inoxydable



DIN EN ISO 13998:2003  
 DIN EN ISO 13998:2003  
 DIN EN ISO 13998:2003

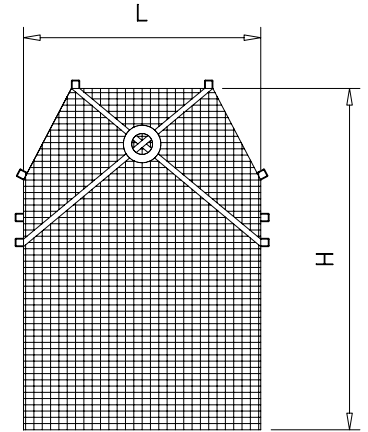

L	H	Kg	Barcode	€
600	800	1,15	448802	<b>165,00</b>

**Delantal de escay**  
 Faux leather apron  
 Tablier en skay

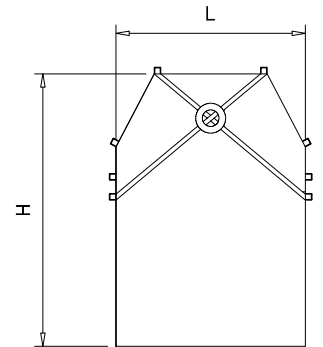

L	H	Gr	Barcode	€
700	1.100	600	448804	<b>19,00</b>

**Guantes alimentarios anticorte**  
 Anti cut gloves for food use  
 Gants alimentaires anti coupure



**El precio es por pareja.**  
 The pair is included in the price.  
 Le paire est inclus dans de prix.

Tamaño Size Dimen- sion		Gr	Barcode	€
≤70	S	100	448670	<b>9,00</b>
71-80	M	110	448672	<b>9,00</b>
81-100	L	115	448674	<b>9,00</b>
≥101	XL	120	448676	<b>9,00</b>



## Guantes para pescadero

Gloves for fishmongers  
Gants pour poissonniers



Excelente protección en las industrias de pesca y viticultura.  
Resistente a los cortes.  
Látex.  
Recubrimiento sobre soporte de algodón afelpado.  
Longitud 300 mm.

Excellent protection for fishing and viticulture industry.  
Cut-resistant.  
Latex.  
Coverage on cotton towel.  
Length 300 mm.

Excellent protection pour les industries de la pêche et la viticulture.  
Résistant aux coupures.  
Latex.  
Recouvrement sur coton pelucheux.  
Longueur 300 mm.



El precio es por pareja.  
The pair is included in the price.  
Le paire est inclus dans de prix.

Talla  
Size  
Taille



Única Universal Unique	250	448668	<b>13,00</b>
------------------------------	-----	--------	--------------

## Guantes anti-salpicaduras aceite hirviendo

Boiling oil anti splash gloves  
Gant anti éclaboussures d'huile bouillant



Guante en piel con recubrimiento de kevlar aluminio en el dorso.

Glove in leather covered with Kevlar-aluminium in the back.

Gant en cuir avec recouvrement en Kevlar-aluminium dans le dos.



El precio es por pareja.  
The pair is included in the price.  
Le paire est inclus dans de prix.

Talla  
Size  
Taille



Única Universal Unique	400	448682	<b>45,00</b>
------------------------------	-----	--------	--------------

## Guantes anticalóricos hasta 100°C

Anticaloric gloves up to 100°C  
Gants anti calorique jusqu'à 100°C



Guante de rizo de algodón para la manipulación de piezas calientes durante un corto plazo, hasta 100°C. Puño de punto de algodón para garantizar un buen ajuste.

Gant en coton éponge pour la manipulation de pièces chaudes pendant une courte période, jusqu'à 150°C. Poignet en tricot de coton pour assurer un bon ajustement.

Cotton terry glove for handling hot stuffs for a short period, up to 150°C. Knitted cotton cuff to ensure a good fit.



El precio es por pareja.  
The pair is included in the price.  
Le paire est inclus dans de prix.

Talla  
Size  
Taille



Única Universal Unique	120	448678	<b>11,00</b>
------------------------------	-----	--------	--------------

## Manoplas anticalóricas hasta 250°C

Anticaloric oven gloves up to 250°C  
Moufles anti caloriques 250°C



Manopla para manipulación de piezas calientes hasta 250°C. Provista de forro de jersey y paravapor insertado entre el rizo y el jersey.

Oven glove for the handle of hot pieces up to 250°C. Provided with pull-over lining and anti-steam inserted between the boucles and the pull-over.

Moufle pour la manipulation des pièces chaudes jusqu'à 250°C. Pourvu de doublure de pull-over et para-vapeur inséré entre les boucles et le pull-over.



El precio es por pareja.  
The pair is included in the price.  
Le paire est inclus dans de prix.

Talla  
Size  
Taille



Única Universal Unique	440	448680	<b>12,00</b>
------------------------------	-----	--------	--------------

## Manoplas anticálóricas hasta 500°C

Anticaloric oven gloves to 500°C  
Moufles anti caloriques jusqu'à 500°C



El precio es por pareja.  
The pair is included in the price.  
Le paire est inclus dans de prix.

Talla Size Taille	Gr		€
-------------------------	----	--	---

Única Universal Unique	600	448681	<b>90,00</b>
------------------------------	-----	--------	--------------

## Guantes para frío extremo en PVC hasta -20°C

Gloves for extreme cold in PVC - temperatures down to -20°C  
Gants pour froid extrême en PVC - températures jusqu'à -20°C



Fabricado en PVC con forro interior en lana.

Made in PVC lined with wool.

Fabriqué en PVC avec doublure en laine.



El precio es por pareja.  
The pair is included in the price.  
Le paire est inclus dans de prix.

Talla Size Taille	Gr		€
-------------------------	----	--	---

Única Universal Unique	420	448690	<b>17,50</b>
------------------------------	-----	--------	--------------

## Guantes para frío extremo en piel

Gloves for extreme cold in leather  
Gants pour froid extrême en cuir



Fabricado en piel de vacuno hidrofugada con interior en fibra de Thinsulate.

Made of damp-proof cow leather lined with Thinsulate fibre.

Fabriqué en cuir de bovine hydrofuge avec l'intérieur en fibre Thinsulate.



El precio es por pareja.  
The pair is included in the price.  
Le paire est inclus dans de prix.

Talla Size Taille	Gr		€
-------------------------	----	--	---

Única Universal Unique	380	448692	<b>17,50</b>
------------------------------	-----	--------	--------------

## Guantes anticorte industrial

Anti-cut industrial gloves  
Gants anticoupure industriel



El precio es por pareja.  
The pair is included in the price.  
Le paire est inclus dans de prix.

Talla Size Taille	Gr		€
-------------------------	----	--	---

Única Universal Unique	40	448684	<b>7,00</b>
------------------------------	----	--------	-------------



**Guantes de piel industrial**  
Industrial leather gloves  
Gants industriel en cuir



**El precio es por pareja.**  
The pair is included in the price.  
Le paire est inclus dans de prix.

Talla  
Size  
Taille



Única  
Universal  
Unique

120	448686	<b>4,00</b>
-----	--------	-------------

**Guantes de protección química**  
Chemical protective gloves  
Gants de protection chimique



**El precio es por pareja.**  
The pair is included in the price.  
Le paire est inclus dans de prix.

Talla  
Size  
Taille



Única  
Universal  
Unique

116	448688	<b>3,75</b>
-----	--------	-------------

**Guantes de nitrilo para uso alimentario**  
Nitrile gloves for food use  
Gants en nitrile pour usage alimentaire



**El precio es por pareja.**  
The pair is included in the price.  
Le paire est inclus dans de prix.

L



380	195	448666	<b>7,50</b>
-----	-----	--------	-------------

**Guantes de nitrilo escamados talla L (caja 50 ud.)**  
Fish-scale grip nitrile gloves – L size (pack of 50 pairs)  
Gants nitrile avec écailles taille L (carton 50 unités)



500	448664	<b>24,00</b>
-----	--------	--------------



## Gafas antiproyecciones

Protective glasses  
Lunettes de protection



Gafa panorámica unilente de policarbonato, compatible con gafas graduadas.

Single lens polycarbonate goggle compatible with prescription glasses.

Lunettes-masques en polycarbonate à une seule verre, compatibles avec des lunettes de vue.

Gr		€
150	448830	<b>1,80</b>

## Pantalla antiproyecciones

Protective mask  
Masque de protection



Gr		€
180	448834	<b>7,00</b>

## Protector auditivo

Hearing Protector  
Protecteur de l'oreille



Protector auditivo ergonómico de alto confort.  
Atenuación alta. SNR: 30dB.  
Almohadilla en el arnés.

Ergonomic hearing protector with superior comfort  
High noise attenuation, SNR 30dB  
Padded headband.

Protection auditive ergonomique avec un confort supérieur  
Atténuation du bruit, SNR 30dB  
Arceau rembourré.

L	A	H	Gr		€
210	80	190	150	448832	<b>7,50</b>

## Botas de agua PVC/Nitrilo

Waterproof boots in PVC/Nitrile  
Bottes pluie en PVC / Nitrile



Talla Size Taille	Gr		€
38	1.568	448850	<b>17,00</b>
39	1.602	448852	<b>17,00</b>
40	1.676	448854	<b>17,00</b>
41	1.786	448856	<b>17,00</b>
42	1.852	448858	<b>17,00</b>
43	2.002	448860	<b>17,00</b>
44	2.098	448862	<b>17,00</b>

### Termómetro digital básico

Basic digital thermometer  
Thermomètre digital basic



Sonda de acero inoxidable de 125 mm. ø 3.5 mm.  
Rango de -50°C a 200°C / Resolución 0,1°C

Stainless steel 125 mm. ø 3.5 mm probe.  
Measurement from -50°C to 200°C / Resolution 0,1°C

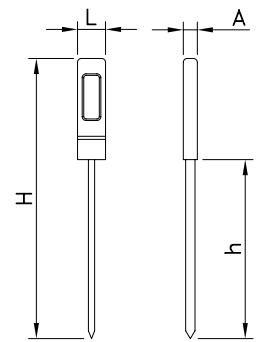

Sonde de 125 mm. ø 3.5 mm. en acier inoxydable.  
Mesurage de -50°C à 200°C / Résolution 0,1°C

L	A	H	h	Gr	Barcode	€
20	20	195	115	24,0	480804	<b>6,00</b>

### Termómetro digital resistente al agua

Water-proof digital thermometer  
Thermomètre digital résistant à l'eau



Sonda rotativa de 127 mm.  
Resistente al agua IP67.  
Rango de -50°C a 300°C.  
Resolución 0,1°C.

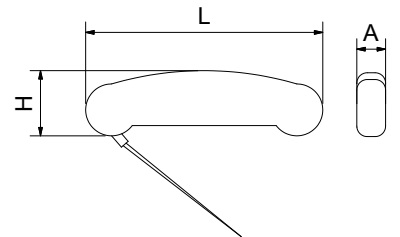

Rotating probe of 127 mm. Water-proof IP67.  
Measuring range: -50°C a 300°C.  
Resolution 0,1°C.

Sonde rotative 127 MM. Étanche IP67.  
Mesurage: -50°C a 300°C. Résolution 0,1°C.

L	A	H	Gr	Barcode	€
180	18	45	36,0	480814	<b>23,00</b>

### Termómetro digital con sonda para frigorífico-congelador

Digital probe thermometer for fridge and freezer  
Thermomètre digital à sonde pour réfrigérateur et congélateur



Rango de -50°C a 70°C / Resolución 0,1°C  
Cable 1.200 mm.  
Con alarma programable.

Measurement from -50°C to 70°C /  
Resolution 0,1°C  
Cable length: 1.200 mm  
Adjustable alarm

Mesurage de -50°C à 70°C / Résolution 0,1°C  
Longueur du câble: 1.200 mm  
Alarme réglable

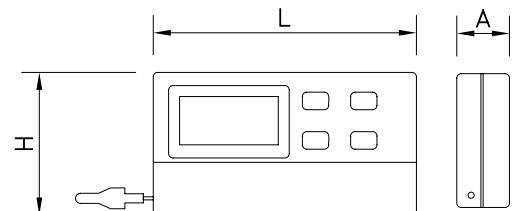

L	A	H	Gr	Barcode	€
60	12	30	80	480806	<b>15,00</b>

### Termómetro digital de acero inoxidable para horno

Stainless steel digital thermometer for oven  
Thermomètre digital en acier inoxydable spécial four



Rango de -50°C a 300°C  
Resolución: 0,1°C  
Cronómetro 99' 59"  
Sonda de acero inoxidable de 110 mm  
Cable de acero inoxidable 1,2 metro  
Alarma  
Imán

Measurement from -50°C to 300°C  
Resolution 0,1°C  
Stopwatch 99' 59"  
Stainless steel probe 110 mm  
Stainless steel cable 1,2 meter  
Alarm  
With magnet

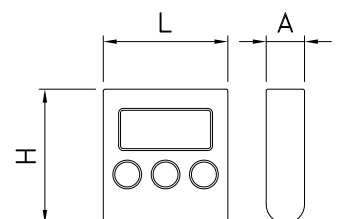

Mesurage de -50°C à 300°C  
Résolution 0,1°C  
Chronomètre 99' 59"  
Sonde inox 110 mm  
Câble inox 1,2 mètre  
Alarme  
Dos aimanté

L	A	H	Gr	Barcode	€
65	16	70	80,0	480842	<b>15,00</b>

## Termómetro barbacoa bluetooth con 6 sondas

Bluetooth barbecue thermometer with 6 probes  
Thermomètre barbecue Bluetooth avec 6 sondes



Rango de 50°C a 300°C / Resolución 1°C  
Cable 1000 mm.

Measurement from 50°C to 300°C / Resolution 1°C  
Cable length: 1000 mm.

Mesurage de 50°C à 300°C / Résolution 1°C  
Longueur du câble: 1000 mm.

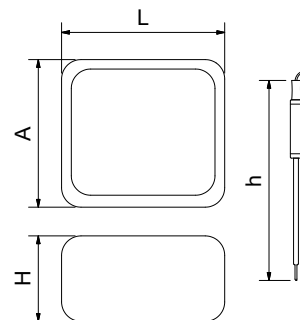

L	A	H	Gr	Barcode	€
84	76	44	475	480816	<b>88,00</b>

## Termómetro para horno con selección de programas wireless

Oven thermometer with wireless program selector  
Thermomètre de four avec sélection de programme sans fil



Rango de 50°C a 300°C / Resolución 1°C  
Cable 1000 mm.

Measurement from 50°C to 300°C / Resolution 1°C  
Cable length: 1000 mm.

Mesurage de 50°C à 300°C / Résolution 1°C  
Longueur du câble: 1000 mm.

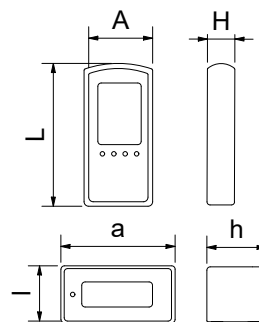

L	A	H	Gr	Barcode	€
80	50	130	220	480808	<b>53,00</b>

## Termómetro electrónico de sonda

Electronic probe thermometer  
Thermomètre à sonde électronique



Sonda de acero inoxidable de 127 mm.  
Rango de -45°C a 200°C / Resolución 0,05°C  
Precisión +/- 1°C  
Funcionamiento a 1 Batería AA de 1.5

Stainless steel 127 mm. probe.  
Measurement from -45°C to 200°C / Resolution 0,05°C  
Deflection +/- 1°C  
Operation at 1 battery AA 1.5

Sonde de 127 mm. en acier inoxydable.  
Mesurage de -45°C à 200°C / Résolution 0,05°C  
Déviation +/- 1°C  
Opération à 1 pile AA 1.5

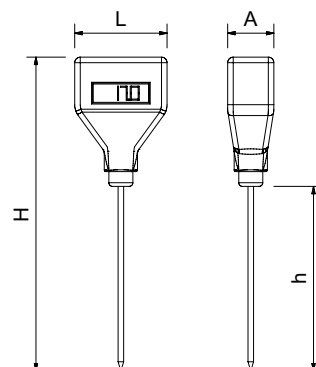

L	A	H	h	Gr	Barcode	€
32	29	143	127	25,0	480802	<b>16,00</b>

## Termómetro digital pistola de infrarrojos

Digital infrared thermometer  
Thermomètre digital à infrarouge



Rango de -50°C a 280°C / Resolución 0.1°C  
Luz en pantalla.

Range from -50°C to 280°C / Resolution 0.1°C  
Screen with backlight. Adjustable alarm

Gamme de -50°C à 280°C / Résolution 0.1°C  
Ecran avec rétro-éclairage.

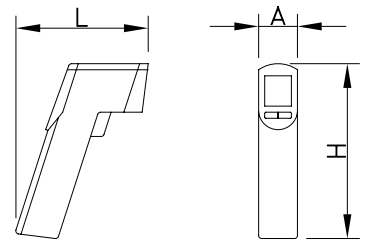

L	A	H	Gr	Barcode	€
75	30	160	220,0	480812	23,00

## Termómetro para barbacoa

Barbecue thermometer  
Thermomètre pour barbaque



Resolución 0.1°C

Resolution 0.1°C

Resolution 0.1°C

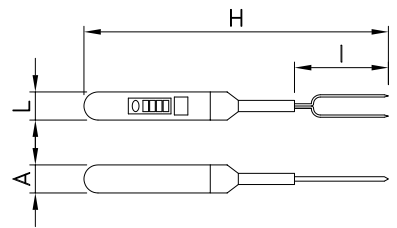

L	A	H	I	Gr	Barcode	€
40	35	430	150	216	480818	22,50

## Termómetro compacto

Compact thermometer  
Thermomètre compact



Sonda de acero inoxidable de 80 mm. ø 3,5 mm.  
Rango de -50°C +200°C / Resolución 0.1°C

Stainless steel 80 mm. ø 3,5 mm. probe.  
Measurement from -50°C to +200°C /  
Resolution 0.1°C

Sonde de 80 mm. ø 3,5 mm. en  
acier inoxydable.  
Mesurage de -50°C à 200°C /  
Resolution 0.1°C

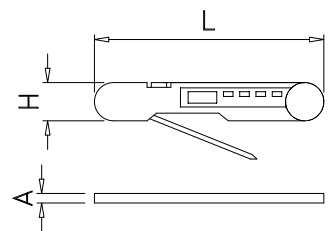

L	A	H	Gr	Barcode	€
140	10	28	80	480821	25,00

## Termómetro con sonda para atornillar

Screw probe thermometer  
Thermomètre avec sonde pour filetage



Sonda de acero inoxidable de 105 mm. ø 8 mm.  
Rango de -50°C +200°C / Resolución 0.1°

Stainless steel 105 mm. ø 8 mm. probe.  
Measurement from -50°C to +200°C / Resolution 0.1°

Sonde de 105 mm. ø 8 mm. en acier inoxydable.  
Mesurage de -50°C à +200°C / Resolution 0.1°

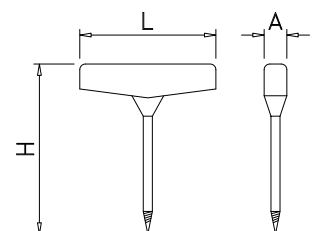

L	A	H	Gr	Barcode	€
120	20	150	145	480830	47,00

## Termómetro pistola con sonda

Pistol thermometer with probe  
Thermomètre en forme de pistolet avec sonde



Sonda de acero inoxidable de 80 mm. ø 3,5 mm.  
Rango de -50°C +200°C / Resolución 0.1°C

Sonde de 80 mm. ø 3,5 mm. en acier inoxydable.  
Mesurage de -50°C à +200°C / Résolution 0.1°C

Stainless steel 80 mm. ø 3,5 mm. probe.  
Measurement from -50°C to +200°C / Resolution 0.1°C

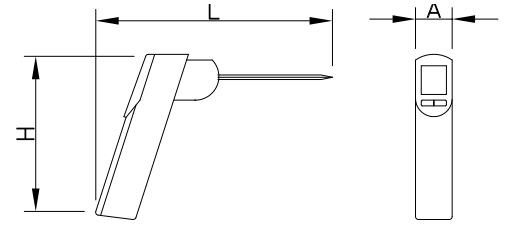

L	A	H	Gr	Barcode	€
75	30	160	250	480832	57,00

## Termómetro con sonda larga

Long probe thermometer  
Thermomètre sonde longue



Sonda de acero inoxidable de 200 mm. ø3,5 mm.  
Rango de -50°C a +200°C / Resolución 0.1°C  
Cable 1000 mm.

Stainless steel 200 mm. ø 3,5 mm. probe.  
Measurement from -50°C to +200°C / Resolution 0.1°C  
Cable length: 1000 mm

Sonde de 200 mm. ø 3,5 mm. en acier inoxydable.  
Mesurage de -50°C à +200°C / Résolution 0.1°C  
Longueur du câble: 1000 mm

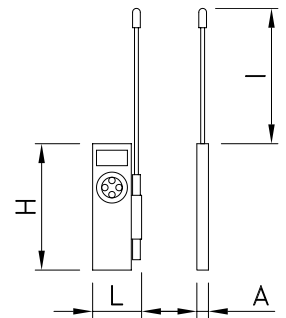

L	I	A	H	Gr	Barcode	€
60	200	18	180	120	480834	20,00

## Registrador de temperatura y humedad

Temperature and humidity recorder  
Enregistreur de température et humidité



### Características:

Resolución: 0,1°C.  
Precisión: +-1°C.  
Resolución humedad: De 1% en 1%.  
Sensor interno + Sonda externa.  
Sonda: 50 mm ø3mm.  
Capacidad de grabación 8000 puntos.  
Intervalo de grabación de 10 sg a 24 horas.  
Cable 1 metro.  
Impermeable IP65.  
Conexión USB.  
Alarma.  
1 pila CR2450-3V.  
De -40 a +85°C con la sonda.  
De -30 a +60°C sin la sonda.  
Registro de humedad de 0 - 99%.

### Characteristics:

Resolution: 0.1°C.  
Accuracy: +-1°C.  
Humidity resolution: every 1%.  
Indoor sensor + outdoor probe.  
Probe: 50 mm ø3mm.  
Can store up to 8.000 measurements.  
Recording intervals can be set from 10 seconds to 24 hours.  
100 cm cable.  
Waterproof IP65.  
USB connection.  
Alarm.  
1 battery CR2450-3V included.  
Range: -30°C to 85°C with probe.  
-30°C to 60°C without probe.  
Humidity record: 0 - 99%.

### Caractéristiques:

Résolution: 0,1°C.  
Précision: +-1°C.  
Résolution humidité : de 1% en 1%  
Capteur interne + la Sonde externe.  
Sonde : 50 mms ø3mm.  
Capacité d'enregistrement de 8000 points.  
Intervalle d'enregistrement de 10 sg à 24 heures.  
Câble de 1 mètre.  
Imperméable IP65.  
Connexion USB.  
Alarme.  
1 pile CR2450-3V.  
De -40 à +85°C avec la sonde.  
De -30 à +60°C sans la sonde.  
Registre d'humidité de 0-99%

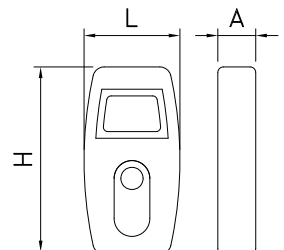

L	A	H	Gr	Barcode	€
43	17	84	102	480852	89,00

**Termómetro para lavavajillas**  
 Dishwasher thermometer  
 Thermomètre pour lave-vaisselle

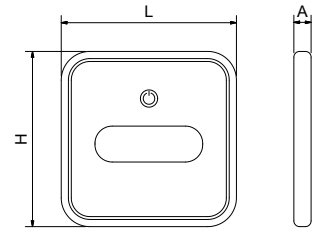

L	A	H	Gr	Barcode	€
122	122	12	130	480864	<b>71,00</b>

**Temporizador digital de cocina**  
 Kitchen digital timer  
 Minuterie de cuisine digital

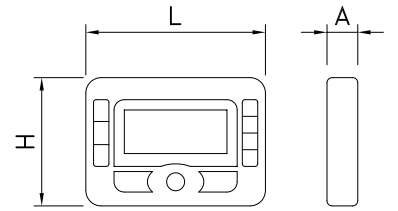

L	A	H	Gr	Barcode	€
72	20	64	80	480836	<b>9,00</b>

**Cronómetro de cocina**  
 Kitchen timer  
 Minuterie de cuisine

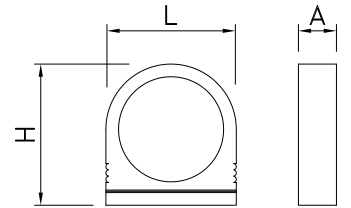

L	A	H	Gr	Barcode	€
60	20	70	120	480838	<b>4,60</b>

**Medidor de compuestos polares / calidad del aceite de fritura**  
 Meter for frying oil quality / polar compounds  
 Mesureur de composés polaires / Qualité de l'huile de friture

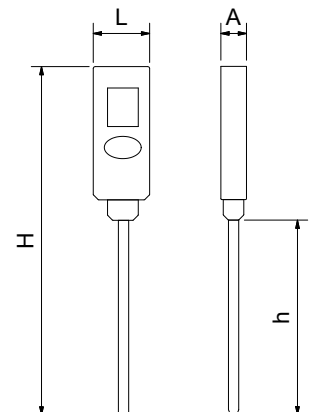

L	A	H	h	Gr	Barcode	€
50	25	340	190	185	480854	<b>450,00</b>

**N**ovedad  
 NEW  
 INVENTAR

**Medidor de PH**  
PH check  
Check pour PH



Characteristics:  
PH pocket meter  
Waterproof with replaceable electrode  
Resolution: 0.1 pH  
Accuracy: +/- 0.1 pH / +/- 1 digit  
Auto-calibration: pH 7.00

Características:  
Medidor de PH de bolsillo  
Impermeable con electrodo intercambiable  
Resolución: 0.1 pH  
Precisión: +/- 0.1 pH / +/- 1 digit  
Auto-calibración: pH 7.00

Caractéristiques:  
PH-mètre de poche  
Étanche avec électrode remplaçable  
Résolution: 0.1 pH  
Précision: 0.1 pH +/- / +/- 1 chiffre  
Auto-calibration: pH 7.00

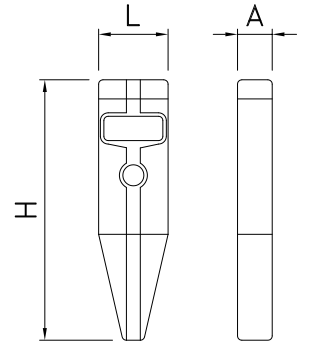

L	A	H	Gr	Barcode	€
40	20	150	350	480828	<b>89,00</b>

**Termómetro infrarrojo para personas**  
Infrared thermometer for use in people  
Thermomètre infrarouge pour personnes

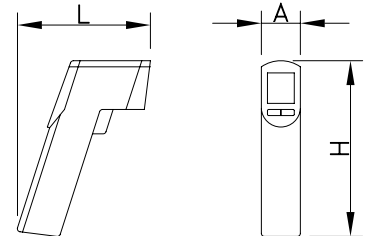

L	A	H	Gr	Barcode	€
120	60	190	210	480856	<b>21,00</b>

**Termómetro infrarrojo mural**  
Wall-mounted infrared thermometer  
Thermomètre infrarouge mural

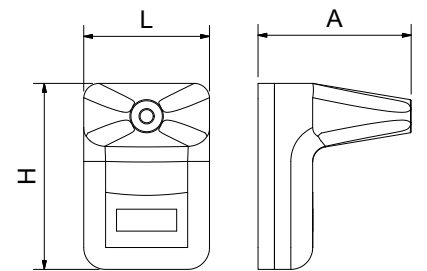

L	A	H	Gr	Barcode	€
115	140	170	350	480858	<b>45,00</b>

**Panel medidor de CO2 monitor de calidad del aire mural / sobremesa**  
Wall / desktop air quality monitor with CO2 detector  
Panneau de mesure de CO2 pour moniteur de qualité de l'air mural / sur table

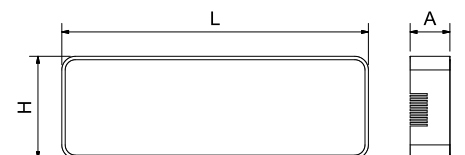

L	A	H	Gr	Barcode	€
270	35	90	270	480862	<b>124,00</b>

## Monitor de calidad del aire detector de CO2

Air quality monitor with CO2 detector

Moniteur de qualité de l'air détecteur de CO2

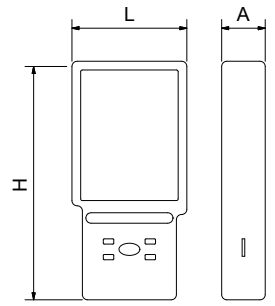

L	A	H	Gr	Barcode	€
66	25	137	112	480860	<b>58,00</b>

## Purificador de aire con filtro HEPA y lámpara UV hasta 60 m2

Air purifier with HEPA filter and UV lamp up to 60 m2

Purificateur d'air avec filtre HEPA et lampe UV jusqu'à 60 m2

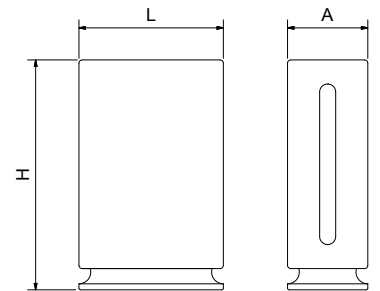

L	A	H	Tensión Voltage Tension	Frecuencia Frequency Frecuence	Potencia Power Puissance	Kg	Barcode	€
360	205	573	230 V	50/60 Hz	35 W	4,50	448540	<b>145,00</b>

## Repuestos para purificador de aire

Spare parts for air purifier

Pièces de remplacement pour purificateur d'air



Filtro repuesto HEPA 13  
HEPA 13 replacement filter  
Filtre HEPA 13 de remplacement

448551 **77,00**



Lampara UV-C 2 pines 10 W.  
2 pin lamp UV-C 10W.  
Lampara UV-C 2 pins 10W.

448552 **20,00**



## Generadores de ozono inyectado para interior de cámaras frigoríficas

Injected Ozone generators for the interior of cold chambers and for indoor atmospheres

Générateurs d'ozone injecté pour l'intérieur de chambres frigorifiques et pour atmosphères d'intérieur



## ¿Qué es el Ozono?

El ozono (O3) es uno de los componentes naturales del aire y su función es la de regular la temperatura y el grado de humedad del ambiente.

Los objetivos de la ozonización son cuatro:

Asepsia de los locales de manipulación, conservación y distribución de alimentos.

Disminución de pérdidas de peso de los alimentos durante su almacenaje.

Desodorización total de los locales y supresión de olores de unos alimentos a otros.

Posibilidad de aumentar el tiempo de almacenaje de los alimentos en un estado óptimo.

En lo que se refiere al primer objetivo, el ozono asegura la destrucción de los numerosos microorganismos que se encuentran en la superficie de los productos alimenticios al introducirlos en las cámaras frigoríficas. Manteniendo la cámara en las condiciones más asépticas posibles se dificulta el contagio de una pieza a otra.

Respecto a las mermas de peso, éstas se deben a las pérdidas de agua de los tejidos animales y vegetales. El ozono evitará en gran parte este proceso.

La desodorización se consigue gracias a la capacidad del ozono para oxidar

la materia orgánica causante de los olores desagradables.

El último objetivo es fácilmente explicable por el amplio espectro antimicrobiano del ozono, capaz de destruir las bacterias, virus, hongos e incluso esporas.

Para más información ponemos a su disposición informes realizados en cámaras frigoríficas destinadas a la conservación de carnes, frutas y pescados.

Tipo de cámara Type of chamber Type de chambre	Coefficiente Coefficient Coefficient
Carnes Meat Viandes	1,5
Pescados Fish Poissons	1,7
Frutas y verduras Fruits & Vegetables Fruits et légumes	1,6
Mixtas Mixed Mixtes	1,5

## What is Ozone?

Ozone (O3) is one of the natural components of the air and its function is to regulate the temperature and the degree of humidity in the atmosphere.

Properties:

The use of ozone in cold-storage chambers is, at present, the only system of environmental decontamination that is radically and definitively effective.

It disinfects, absorbs odours and sterilizes.

It destroys fungi, bacteria and viruses - even the most resistant microbes - and thus losses are significantly reduced in the ozonized chambers. It also prevents the mixing of odours.

For further information, we can provide you with reports produced on refrigerated chambers used for the storage of meat, fruit and fish.

## Qu'est-ce que l'ozone ?

L'ozone (O3) est l'un des composants naturels de l'air et sa fonction consiste à régler la température et le degré d'humidité de l'atmosphère.

Propriétés:

L'apport d'ozone aux chambres frigorifiques est actuellement le seul système de décontamination environnementale qui agit de façon radicale et définitive.

Il désinfecte, désodorise et stérilise.

Il détruit les champignons, les bactéries et même les microbes les plus résistants, aussi les pertes dans les chambres frigorifiques sont-elles considérablement réduites. Il évite le mélange d'odeurs.

Pour plus d'informations, nous mettons à votre disposition des rapports effectués dans des chambres frigorifiques destinées à la conservation de viandes, de fruits et de poissons.

## How to select the ideal equipment ?

Multiply the volume (in m3) of the chamber to be ozonized by the coefficient corresponding to the type in question. We must then choose the equipment whose production in mg/h most closely relates to that figure.

E.g. In a mixed chamber of 4 x 3 x 3 m, the calculation would be as follows:

$$4 \times 3 \times 3 = 36 \text{ m}^3$$

$$36 \times 1,5 = 54$$

In this case, the required model would be the H-20.

## Comment choisir l'équipement idéal ?

Multiplier le volume (en m<sup>3</sup>) de la chambre à ozoniser par le coefficient correspondant au type de chambre. L'on doit choisir l'équipement dont la production de mg/h s'adaptera le mieux. Par ex., dans une chambre mixte de 4 x 3 x 3 m, le calcul sera le suivant:

$$4 \times 3 \times 3 = 36 \text{ m}^3$$

$$36 \times 1,5 = 54$$

Dans ce cas, le modèle nécessaire serait le H-20.

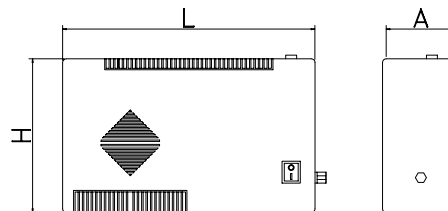

## ¿Cómo elegir el equipo idóneo?



Multiplicar el volumen (en m<sup>3</sup>) de la cámara a ozonizar por el coeficiente correspondiente al tipo de cámara. Debemos escoger el equipo cuya producción de mg/h más se ajuste. p. ej. En una cámara mixta de 4 x 3 x 3 m el cálculo sería el siguiente:

$$4 \times 3 \times 3 = 36 \text{ m}^3$$

$$36 \times 1,5 = 54$$

En este caso, el modelo necesario sería el H-20.

Uso Wearing Usage	Coefficiente Coefficient Coefficient
Olor penetrante Penetrating smell Odeur pénétrant	0,8
Olor intenso Intense smell Odeur intense	0,7
Olor moderado Moderated smell Odeur modéré	0,6

Modelo Type Modèle	L	A	H	Producción Production Production mg/h	Tensión Voltage Tension	Frecuencia Frequency Fréquence	Potencia Power Puissance	Barcode	€	
	H-10	355	110	220	30	220 V	50 Hz	15 W	485202	<b>540,00</b>
	H-20	355	110	220	60	220 V	50 Hz	18 W	485204	<b>570,00</b>
	H-30	355	110	220	90	220 V	50 Hz	19 W	485206	<b>600,00</b>
	H-50	400	170	450	500	220 V	50 Hz	55 W	485208	<b>2.600,00</b>
	H-100	400	170	450	1.000	220 V	50 Hz	70 W	485212	<b>3.200,00</b>

## Cañón de ozono portátil 7.000 mg/h

Portable ozone cannon 7.000 mg/h  
Portable ozone generator 7.000 mg/h

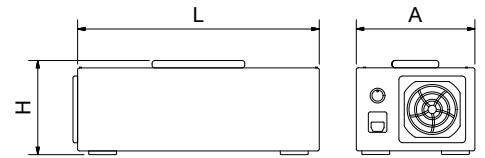

L	A	H	Tensión Voltage Tension	Frecuencia Frequency Frecuence	Potencia Power Puissance	Producción Production Production mg/h	Kg	Barcode	€
370	165	250	230 V	50/60 Hz	80 W	7.000	3,00	448424	<b>450,00</b>

## Ozonizador de agua

Ozone generator for water with tap  
Générateur d'ozone pour l'eau avec robinet



### Características:

Gracias a este equipo generador de ozono se consigue agua ozonizada, ideal para realizar una colada más eficiente que el jabón y, además, sin añadir contaminantes al agua ni al entorno. Limpiar y desinfectar con agua ozonizada es una solución altamente higiénica.

Además de su uso principal, incorpora un grifo para el llenado de utensilios de lavado para suelos, superficies, etc. Incluso puede utilizarse para enjuagar frutas y verduras.

Este agua deberá utilizarse durante los primeros 15/20 minutos, pues posteriormente perderá sus propiedades desinfectantes.

\*El agua tratada por este equipo es únicamente para el lavado y desinfección. No para consumo.

\*Las propiedades del ozono sólo son efectivas en agua fría.



### Characteristics:

This ozone generator device will provide you ozonated water. Cleaning and disinfecting with ozonated water is a highly hygienic solution. It is supplied with a tap for filling washing containers.

\*The water treated by this device is only intended for washing and disinfection. Not for consumption.

\*Ozone properties are only effective in cold water.

### Caractéristiques:

Grâce à cet équipement générateur d'ozone, on obtient de l'eau ozonée. Le nettoyage et la désinfection à l'eau ozonée est une solution hautement hygiénique.

Il intègre un robinet pour le remplissage des ustensiles de lavage.

\*L'eau traitée par cet équipement est uniquement destinée au lavage et à la désinfection. Pas pour la consommation.

\*Les propriétés de l'ozone ne sont efficaces que dans l'eau froide.

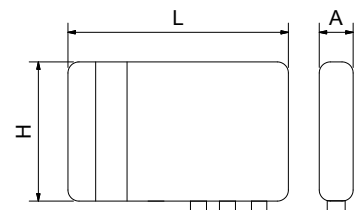

L	A	H	Tensión Voltage Tension	Frecuencia Frequency Frecuence	Potencia Power Puissance	Flow Débit	Kg	Barcode	€
450	78	250	100-240V	50Hz	240 W	2,5-5 l/min	4,50	448410	<b>386,00</b>

## Cortina de ozono especial pescaderías

Ozone curtain, especially for fishmongers  
Rideau d'ozone spécial pour poissonneries



### Características:

Reducción máxima del fuerte olor que desprende la sección de pescadería.  
Mantiene durante más tiempo el aspecto de los pescados expuestos sobre el mostrador.  
Reduce la carga microbiana presente en el pescado.  
Fácil instalación.

### Characteristics:

Maximum reduction of odors that are generated in fishmongers.  
It keeps the good appearance of fishes exhibited in displays.  
It eliminates the microbes present in fishes.  
Easy to install.

### Caractéristiques:

Réduction maximale des odeurs qui sont générés dans les poissonneries.  
Il maintient la bonne apparence des poissons exposés dans les écrans.  
Il élimine les microbes présents dans les poissons.  
Facile à installer.

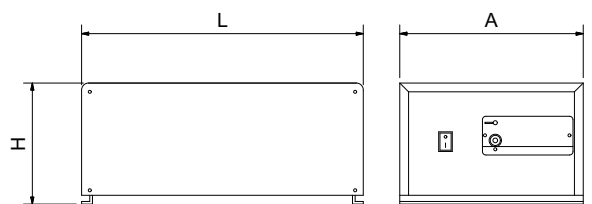
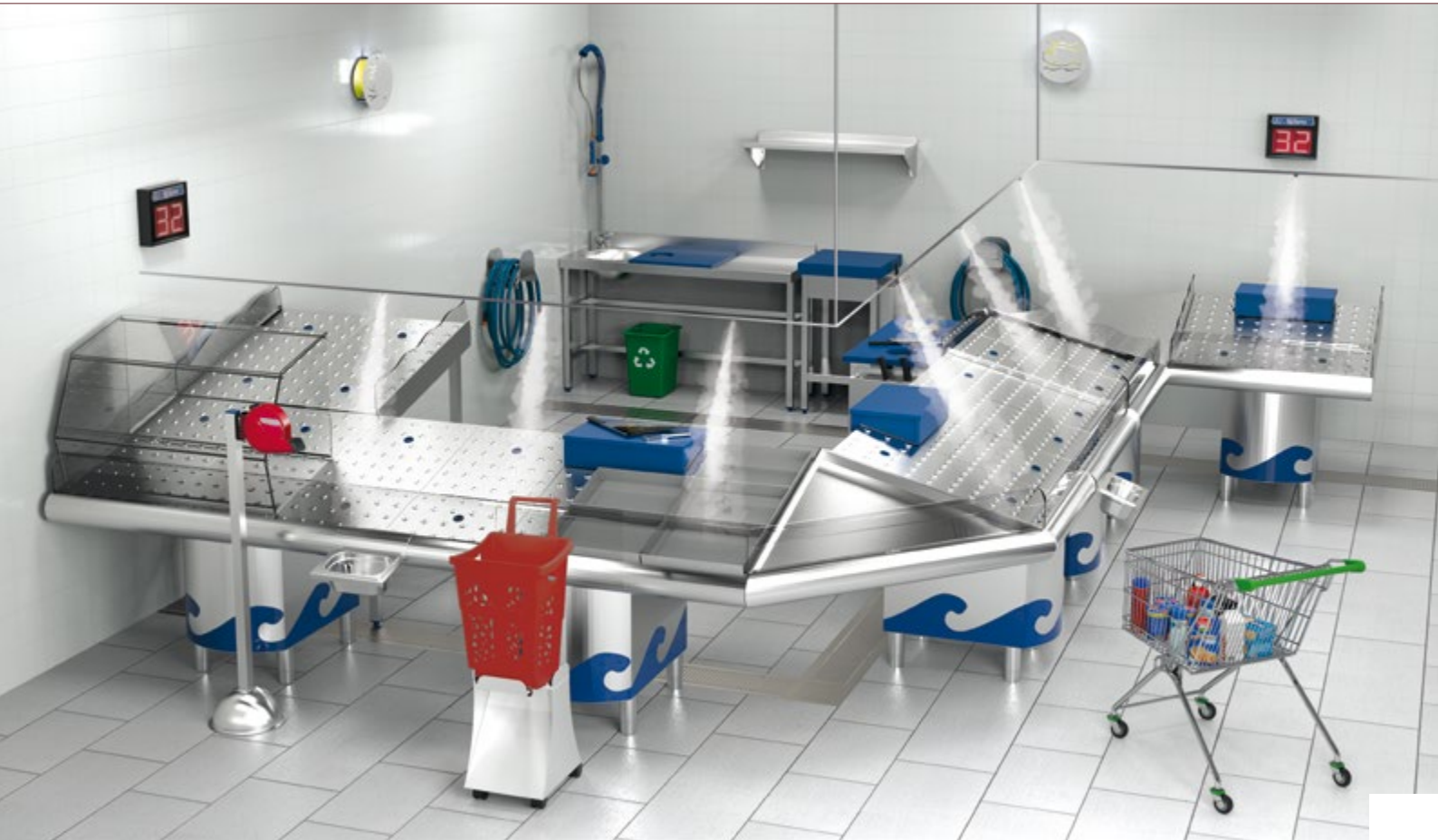

L	A	H	↔	Tensión Voltage Tension	Frecuencia Frequency Fréquence	Potencia Power Puissance	Kg	Barcode	€
380	200	160	0-10 mts.	220 V	50 Hz	80 W	5,00	448430	<b>2.443,00</b>

## Esterilizador de cuchillos mediante agua caliente para adosar

Hot water knifeholder disinfectant for mounting  
Porte-couteaux désinfecteur à l'eau chaude pour adosser



### Características:

Entrada de agua y desagüe con llave de corte, rebosadero, resistencia eléctrica protegida con termostato. Capacidad: 24 cuchillos.

### Characteristics:

Water inlet and drain with stopcock, overflow, electrical resistance protected with thermostat. Capacity: 24 knives.

### Caractéristiques:

Entrée d'eau et robinet d'écoulement, déversoir, résistance électrique avec thermostat. Capacité: 24 couteaux.



**Cuchillero con alojamiento especial para tijeras y chairas.**

Knife-holder with special lodging for scissors and sharpeners.  
Porte-couteaux avec logement spécial pour ciseaux et fusils à affûter.



**Repuestos.**  
Spare parts.  
Pièces de rechange.

375

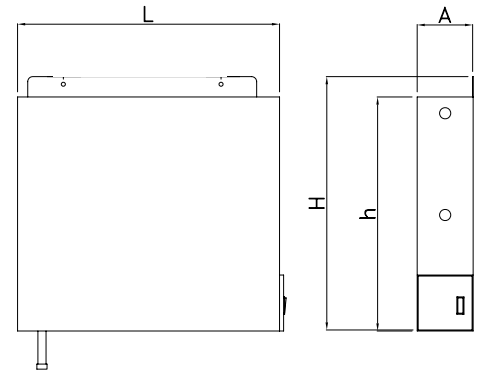

L	A	H	h	Tensión Voltage Tension	Frecuencia Frequency Fréquence	Potencia Power Puissance	Kg	Barcode	€
515	105	490	460	220 V	50 Hz	1.000 W	10,65	040402	<b>693,00</b>

## Esterilizador de cuchillos mediante ozono para adosar

Ozone knifeholder disinfectant for mounting  
Porte-couteaux désinfecteur à l'ozone pour adosser



### Características:

Interruptor luminoso On/Off. Toma de tierra.

### Characteristics:

On/Off lighting switch. Ground.

### Caractéristiques:

Interrupteur lumineux On/Off. Prise de terre.

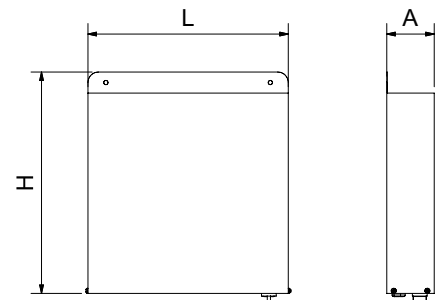

**Capacidad: 20 cuchillos**  
Capacity: 20 Knives  
Capacité: 20 couteaux



**Repuestos.**  
Spare parts.  
Pièces de rechange.

375

L	A	H	Tensión Voltage Tension	Frecuencia Frequency Fréquence	Potencia Power Puissance	Kg	Barcode	€
380	90	420	220 V	50 Hz	6 W	5	040472	<b>227,00</b>

## Armarios esterilizadores de cuchillos rayos U.V.

U.V. knives disinfectant cabinets

Armoires désinfectants de couteaux U.V.



### Principios de funcionamiento:

La lámpara emite rayos ultravioletas germicidas que transforman el oxígeno en ozono, destruyendo así las bacterias mediante la hiper-oxidación.

No es preciso demostrar ya el efecto de la radiación U.V.C. Es totalmente bactericida, antiviral, germicida, etc.

Los armarios generadores de U.V.C. aseguran así una excelente descontaminación de los utensilios situados en los cuchilleros.

Estos armarios, en conformidad con las normas de higiene, encuentran su aplicación en todos los sectores de la industria y de los comercios de la alimentación.

Construidos en acero inoxidable, están concebidos para durar y para ser instalados incluso en ambientes húmedos.

### Working:

The lamp emits ultraviolet germinated rays, that transform oxygen into ozone, destroying the germs by hiper-rusting. It is not necessary demonstrate the effect of the radiation U.V.C. It is totally bacterized, anti-virus, germicized, etc. The U.V. generator cabinet assure the excellent descontamination of the tools. These in compliande with all hygiene norms, find application in every industrial sector and food commerce. They are made of stainless steel, and are made to last and be installed even in humid places.



Barra para colgar accesorios.

Utensil rack.

Barre pour accrocher des accessoires.

375



### Fonctionnement:

La lampe émet des rayons ultraviolets germicides, qui transforment l'oxigène en ozone, en détruisant les bactéries par l'hiper-oxidation. Il n'est pas précis démontrer l'effect de la radiation U.V.C. C'est totalement bactericide, antiviral, germicide, etc.

Les armoires générateur U.V. assurent comme ça une excelente décontamination des outils. Cettés armoires, en obeiant avec le normes d'hygiene, trouvent application dans tout les secteurs de l'industrie et des commerces d'alimentation.

Construit en acier inoxydable, il sont conçus pour une longue durée et pour son installation même sous atmosphères humides.

### Características:

Construido en chapa de acero inoxidable acabado esmerilado.

Lámpara U.V.C.

### Characteristics:

Made of stainless steel polish finished.

Lamp U.V.C.

### Caractéristiques:

Construit en acier inoxydable.

Lamp U.V.C.



Enchufe con mando a distancia.

Remote controlled RF socket.

Connectez avec télécommande.

374

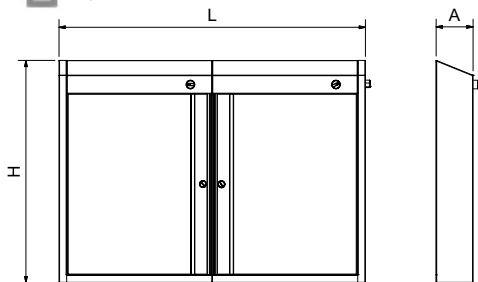

Capacidad 20 y 40 cuchillos respectivamente

Capacity 20 and 40 knives respectively

Capacité 20 et 40 couteaux respectivement

Includido / Included / Inclus Opcional / Optional / Optionnel

L	A	H	Tensión Voltage Tension	Frecuencia Frequency Fréquence	Potencia Power Puissance			€
523	120	723	220 V	50 Hz	15 W	9,00	040450	<b>551,00</b>
996	120	723	220 V	50 Hz	30 W	17,00	040452	<b>958,00</b>



Repuestos.

Spare parts.

Pièces de rechange.

375

## Armario esterilizador de cuchillos mediante Ozono

Ozone sterilizing cabinet for knives

Armoire stérilisateur de couteaux à l'ozone



### Características:

Armario construido en acero inoxidable de gran espesor.  
Interruptor luminoso On/Off.  
Toma de tierra.

### Characteristics:

Cabinet made of stainless steel.  
On/Off lighting switch.  
Ground.

### Caractéristiques:

Construit en acier inoxydable.  
Interrupteur lumineux On/Off.  
Prise de terre.



Enchufe con mando a distancia.  
Remote controlled RF socket.  
Connectez avec télécommande.

374



Barra para colgar accesorios.  
Utensil rack.  
Barre pour accrocher des accessoires.

375



Capacidad 20 y 40 cuchillos respectivamente  
Capacity 20 and 40 knives respectively  
Capacité 20 et 40 couteaux respectivement

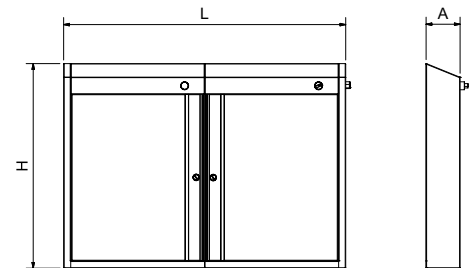

Incluido / Included / Inclus    Opcional / Optional / Optionnel



Repuestos.  
Spare parts.  
Pièces de rechange.

375

L	A	H	Tensión Voltage Tension	Frecuencia Frequency Fréquence	Potencia Power Puissance	Kg	Barcode	€
523	120	723	220 V	50 Hz	6 W	9	040460	<b>473,00</b>
996	120	723	220 V	50 Hz	12 W	17	040462	<b>825,00</b>

## Armario inox esterilizador de utillaje y calzado

Stainless steel sterilisers wardrobe for tools and shoes

Armoire inoxydable pour la stérilisation des outils et des chaussures



### Características:

3 niveles para colgar botas y zapatos  
Sistema de desinfección por ozono.

Characteristics:  
3 racks for hanging boots and shoes  
Disinfection system:  
Ozone

Caractéristiques:  
3 niveaux pour ranger  
bottes et chaussures  
Système de désinfection:  
Ozone



El pomo admite la colocación de candado.  
Handle-holder kit.  
Kit porte-manches.



351

Opcional / Optional / Optionnel



Posibilidad de acoplar ruedas ver pág 497  
Possibility of assembly wheels, see page 497  
Possibilité d'accoupler rouelles, voir page 497

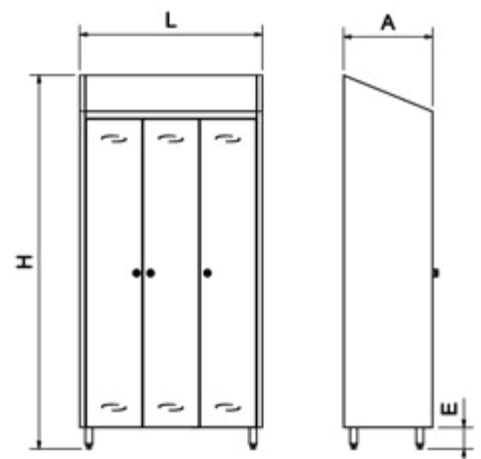

L	A	H	E		Tensión Voltage Tension	Frecuencia Frequency Fréquence	Potencia Power Puissance			€
985	480	2010	115	3	220 V	50 Hz	6 W	57,50	081610	<b>1.797,00</b>

## Portacuchillos inox portátil

Portable stainless steel knife holder  
Porte couteaux inoxydable transportable



Válido para acoplar a los siguientes modelos de esterilizadores de cuchillos:  
Valid for being adapted to the following models knife sterilisers:  
Valable pour être adaptés aux modèles suivants de stérilisateur à couteaux:



040452  
040462



040450  
040460



040472



Capacidad: 20 cuchillos  
Capacity: 20 Knives  
Capacité: 20 couteaux

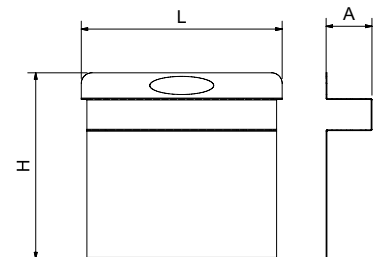

L	H	A	Kg	Barcode	€
377	350	86	2,40	041050	55,00

## Accesorios

Accessories  
Accessoires



Enchufe con mando a distancia  
Remote controlled RF socket  
Connectez avec télécommande

Tensión Voltage Tension	Frecuencia Frequency Fréquence	Range	Battery	Gr	Barcode	€
-------------------------------	--------------------------------------	-------	---------	----	---------	---

240V 50 Hz 30 mts. A23-12v 215 485892 19,00

Consumo máximo admisible 3.600 W.  
3.600 W Maximum admissible consumption.  
Consommation maximale autorisée 3.600 W.



## Repuestos para esterilizadores

Spare parts for sterilizing cabinets

Pièces de remplacement pour stérilisateurs



Resistencia  
Résistance  
Resistance

900 449040 **175,00**



Interruptor luminoso On/Off  
On/Off lighting switch  
Interrupteur lumineux On/Off

10 448480 **29,00**



Adhesivo ventana  
Sticker for door screen  
Autocollant pour fenêtre à porte

10 480222 **8,50**



Cerradura  
Lock  
Serrure

41 481404 **5,50**



Lámpara de 15 W.  
15 W. lamp  
Lampe de 15 W.

80 448508 **32,00**



Lámpara de 30 W.  
30 W. lamp  
Lampe de 30 W.

150 448510 **68,00**



Barra para colgar accesorios  
Utensil rack  
Barre pour accrocher des accessoires

9 240438 **3,68**



## Exterminador de insectos mediante parrilla eléctrica serie UK-INOX

Insect killer by electric grill UK-INOX series  
Désinsectiseur à grill électrique modèle UK-INOX



UK-50 LED



UK-100 LED



UK-240 LED

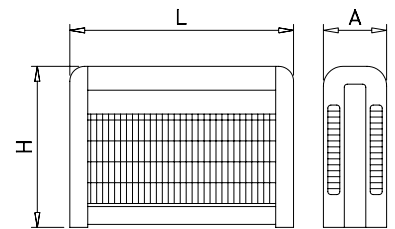

L	A	H	Modelo Model Modèle	Potencia Power Puissance	Frecuencia Frequency Fréquence	Tensión Voltage Tension	Bombilla Light bulb Ampoule	Cobertura Coverage Couverture	Consumo Consumption Consommation	Kg	Barcode	€
380	105	260	UK-50 LED	9 w	50/60 Hz	220-240 V	1x7 W LED	50 m <sup>2</sup>	9 W	2,8	485808	<b>82,00</b>
380	105	260	UK-100 LED	16 w	50/60 Hz	220-240 V	2x7 W LED	100 m <sup>2</sup>	16 W	3,4	485810	<b>100,00</b>
695	105	285	UK-240 LED	30 w	50/60 Hz	220-240 V	4x7 W LED	240 m <sup>2</sup>	30 W	5,7	485812	<b>149,00</b>

## Exterminador de insectos mediante trampa adhesiva serie UL

Insect killer by glue board UL series  
Désinsectiseur à piège adhésif modèle UL



### Características:

Silencioso y discreto. Diseño moderno y compacto. Placa adhesiva de fácil sustitución, con mayor área de captación. El aparato no sólo atrae más insectos que los aparatos convencionales, sino que además lo hace de forma más higiénica. Material de alta calidad, fácil mantenimiento. 2 años de garantía.

### Characteristics:

Silent and sober. Modern and compact design. Easy to replace adhesive trap, with higher coverage area. This device not only appeals more insects than the conventional ones, but it also does it in a more hygienic way. High quality material and easy maintenance. 2 years of guarantee.

Caractéristiques:  
Silencieux et sobre. Design d'avant garde et compact. Trappe adhésif facile à substituer, avec plus grande zone de couverture. L'appareil non seulement attire plus d'insectes mais encore il les attire d'une forme plus hygiénique. Matériel d'haute qualité et facile maintien. Garantie de 2 années.

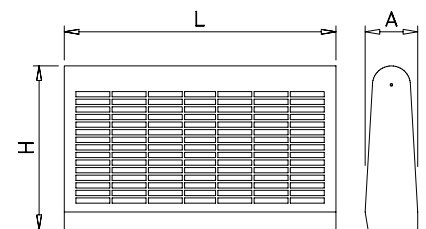

L	A	H	Modelo Model Modèle	Potencia Power Puissance	Frecuencia Frequency Fréquence	Tensión Voltage Tension	Tubo Tube Tube	Cobertura Coverage Couverture	Consumo Consumption Consommation	Kg	Barcode	€
470	95	290	UL-80	35 W	50 Hz	220-240 V	2x15 W	80 m <sup>2</sup>	45 W	3,85	485838	<b>119,00</b>

## Exterminador de insectos mediante trampa adhesiva serie MR LED

Insect killer by glue board MR LED series  
Désinsectiseur à piège adhésif modèle MR LED



### Características:

Silencioso y discreto.  
Diseño moderno y compacto.  
Placa adhesiva de fácil sustitución, con mayor área de captación. (1 unidad incluida)  
El aparato no sólo atrae más insectos que los aparatos convencionales, sino que además lo hace de forma más higiénica ya que se quedan pegados a la trampa y no se desprenden del aparato.  
Material de alta calidad, fácil mantenimiento.  
2 años de garantía.  
\* Recambios de trampas adhesivas correspondientes a este modelo: 485898

### Characteristics:

Silent and discreet.  
Modern and compact design.  
Easy to replace adhesive trap, with higher coverage area. (1 unit included)  
This device not only attracts more insects than the conventional ones, but it also does it in a more hygienic way.  
High quality material and easy maintenance.  
2 years of guarantee.  
\* Spare parts of adhesive traps corresponding to this model: 485898

### Caractéristiques:

Silencieux et sobre.  
Design d'avant garde et compact.  
Trappe adhésif facile à substituer, avec plus grande zone de couverture. (1 pièce incluse)  
L'appareil non seulement attire plus d'insectes mais encore il les attire d'une forme plus hygiénique.  
Matériel d'haute qualité et facile maintien.  
Garantie de 2 années.  
\* Pièces détachées de pièges adhésifs correspondant à ce modèle: 485898.

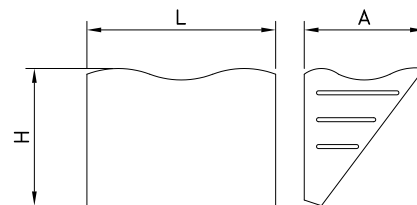

L	A	H	Modelo Model Modèle	Potencia Power Puissance	Frecuencia Frequency Fréquence	Tensión Voltage Tension	Tubo Tube Tube	Cobertura Coverage Couverture	Consumo Consumption Consommation	Kg	Barcode	€
460	180	151	MR-50 LED	9 W	50/60 Hz	100-240 V	1x7 W	50 m <sup>2</sup>	9 W	2,7	485805	<b>84,00</b>

## Exterminador de insectos serie SP-80 LED

Insect killer by glue board SP-80 LED series  
Désinsectiseur à piège adhésif modèle SP-80 LED

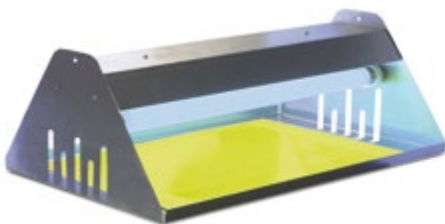

### Características:

Silencioso, discreto, sin explosión de insectos y sin olores.  
El aparato no sólo atrae más insectos que los aparatos convencionales, sino que además lo hace de una manera más higiénica al quedar el insecto atrapado en su trampa de film adhesivo, resistente a la humedad y rayos UV.  
Permite una instalación colgante o mural, incluye kit necesario de cadena y soportes.

### Caractéristiques:

Silencieux, discret, sans explosion d'insectes et sans odeurs.  
Le dispositif non seulement attire plus d'insectes que les dispositifs classiques, mais aussi le fait de forme plus hygiénique car l'insecte reste attrapé dans son piège de film adhésif, résistant à l'humidité et aux rayons UV.  
Il permet une installation en suspension ou murale, le kit comprend la chaîne et les supports.

### Characteristics:

Silent, discreet and odor free. No insect explosion.  
This device not only attracts more insects than the conventional ones, but also does it in a more hygienic way since the insects are trapped on its glue trap, resistant to moisture and UV rays.  
For hanged or wall installation, chain and supports included.

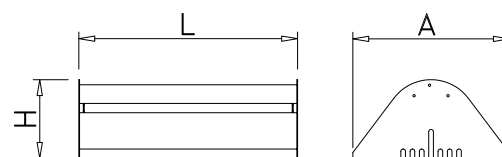

L	A	H	Modelo Model Modèle	Potencia Power Puissance	Frecuencia Frequency Fréquence	Tensión Voltage Tension	Tubo Tube Tube	Cobertura Coverage Couverture	Consumo Consumption Consommation	Kg	Barcode	€
485	160	350	SP-80 LED	16 W	50/60 Hz	100-240 V	2x8 W LED	80 m <sup>2</sup>	16 W	4,0	485806	<b>120,00</b>

## Exterminador de insectos interior/externo mediante parrilla eléctrica Serie LD120

Insect killer by electric grill indoor / outdoor LD120 Series

Désinsectiseur à grill Électrique intérieur / extérieur LD120 Series

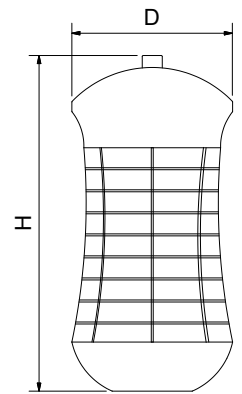

D	H	Modelo Model	Potencia Power	Frecuencia Frequency	Tensión Voltage	Bombilla Light bulb	Cobertura Coverage	Consumo Consumption	Kg	Barcode	€
160,5	335	LD-120	8 W	50/60 Hz	220-240 V	UV-A LED 18 w	120 m <sup>2</sup>	8 W	0,89	485834	<b>45,00</b>

## Exterminador de insectos mediante trampa adhesiva Serie V30

Insect killer by glue board V30 Series

Désinsectiseur à piège adhésif Série V30

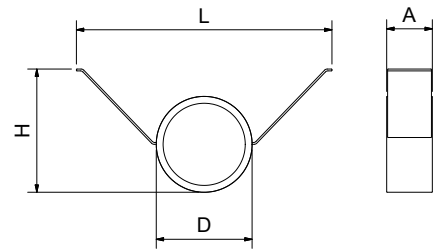

L	A	D	H	Modelo Model	Potencia Power	Frecuencia Frequency	Bombilla Light bulb	Cobertura Coverage	Consumo Consumption	Kg	Barcode	€
280	50	105	135	V-30	5 W	50-60 Hz	8 x UV-A LED x 0,63 w	30 m <sup>2</sup>	5 W	0,16	485836	<b>20,00</b>

## Bombilla LED antimosquitos

Anti-mosquito LED bulb

Bombilla LED antimosquitos



### Características:

Bombilla 2 en 1 que sirve como iluminación y como trampa de insectos voladores.

### Characteristics:

2-in-1 bulb that serves as lighting and as a trap for flying insects.

### Caractéristiques:

Bombilla 2 en 1 que sirve como iluminación y como trampa de insectos voladores.

D	H	Potencia Power	Frecuencia Frequency	Tensión Voltage	Cobertura Bulb socket	Consumo Consumption	Gr	Barcode	€
165	90	8 W	50/60 Hz	85-265 V	E27	15 W	150	485899	<b>15,00</b>

## Exterminador de insectos mediante trampa adhesiva serie BC

Electric glue board fly killer BC series

Exterminateurs d'insectes à trappe adhésif serie BC



### Características:

El diseño innovador de la serie BC agrupa la eficiencia del control de insectos voladores y la estética contemporánea y moderna de un aplique de luz. Sus diferentes diseños permiten escoger el modelo que mejor se integre con el lugar de utilización.

Sus ventajas con respecto a otros aparatos son:

Construidos en acero inoxidable.

Diseño exclusivo. Carátulas intercambiables.

Silenciosos.

Ahorro energético: Lámpara de bajo consumo. Sin transformadores, cebadores, etc. garantizando fiabilidad y poco mantenimiento.

Posibilidad de lavarlos o esterilizarlos al poderse introducir en máquinas de lavado, lavavajillas o directamente bajo el agua, desmontando fácilmente y sin herramientas la parte eléctrica.

Ideal para cualquier lugar donde el control de los insectos deba ser discreto y el uso de un exterminador convencional resultaría inapropiado. Recomendado para restaurantes, cafeterías, bares, hoteles, oficinas, tiendas de alimentación, zonas de manipulación de alimentos etc.

### Characteristics:

The innovative design of BC series joins the efficiency in flying insect control and the contemporary and modern aesthetic of a wall lamp. Its different designs allow you to choose the most suitable model for the place of usage.

Its advantages in relation to other devices are:

Made of stainless steel.

Exclusive design with exchangeable covers.

Silent.

Power saving with low consumption lamps. Without transformers, chokes, etc. It guarantees liability and low maintenance.

Possibility of washing or sterilizing in washing machines, dishwashers or directly under water, just dismantling the electrical components easily, without any tool.

Perfect for any place where the insect control must be discrete and the usage of a conventional insect killer would be inadequate. It is recommended for restaurants, cafes, bars, hotels, offices, food shops, food preparation areas, etc.

### Caractéristiques:

Le design innovateur du modèle BC attache l'efficacité du control des insectes volants et l'esthétique contemporaine et moderne d'un applique. Son designs différents permettent choisir le modèle que plus s'intègre avec l'endroit d'utilisation.

Les avantages par rapport autres modèles sont :

Construit en acier inoxydable.

Design exclusif avec façades interchangeables.









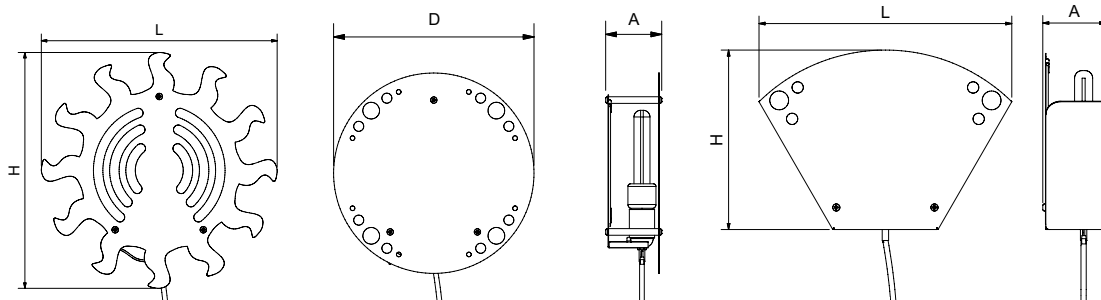























Silencieuses.

Économie énergétique. Lampe de consommation bas sans transformateur ou poire qui garantie fiabilité et maintenance. Possibilité de le laver ou le stériliser puisque il peut se mettre dans machines à laver, lave-vaisselles ou directement sous l'eau. Facile à démonter sans outils.

Parfait pour quelque endroit où le control des insectes doit être discret et l'usage d'un exterminateur conventionnel serait inadéquat. Recommandé pour restaurants, cafés, bars, hôtels, bureaux, magasins d'alimentation, zones de manipulation d'aliments, etc.





	L	D	A	H	Modelo Model Modèle	Potencia Power Puissance	Cobertura Coverage Couverture	W	Tensión Voltage Tension	Frecuencia Frequency Fréquence	Kg	Barcode	€
		300	84		Industrial		20 W	50 m <sup>2</sup>	20 W	220/240 V	50/60 Hz	1,1	085810 <b>108,00</b>
													086010 <b>126,00</b>
	336		84	240	AP-INOX		20 W	50 m <sup>2</sup>	20 W	220/240 V	50/60 Hz	1,7	085812 <b>117,00</b>
													086012 <b>135,00</b>
	350		84	350	Sol		20 W	50 m <sup>2</sup>	20 W	220/240 V	50/60 Hz	0,96	085802 <b>135,00</b>
													086002 <b>151,00</b>
	280		84	300	Luna		20 W	50 m <sup>2</sup>	20 W	220/240 V	50/60 Hz	1,13	085804 <b>110,00</b>
	300		84	345	Estrella		20 W	50 m <sup>2</sup>	20 W	220/240 V	50/60 Hz	0,94	085806 <b>110,00</b>
	343		84	269	Nube		20 W	50 m <sup>2</sup>	20 W	220/240 V	50/60 Hz	1,10	085808 <b>110,00</b>
	271		84	315	Manzana		20 W	50 m <sup>2</sup>	20 W	220/240 V	50/60 Hz	1,04	085814 <b>110,00</b>
	310		84	293	Cerezas		20 W	50 m <sup>2</sup>	20 W	220/240 V	50/60 Hz	0,96	085816 <b>110,00</b>
	300		84	300	Pollería		20 W	50 m <sup>2</sup>	20 W	220/240 V	50/60 Hz		085818 <b>110,00</b>
	300		84	300	Queso		20 W	50 m <sup>2</sup>	20 W	220/240 V	50/60 Hz		085821 <b>110,00</b>
	300		84	300	Carnicería		20 W	50 m <sup>2</sup>	20 W	220/240 V	50/60 Hz		085822 <b>110,00</b>
	300		84	300	Charcutería		20 W	50 m <sup>2</sup>	20 W	220/240 V	50/60 Hz		085824 <b>110,00</b>
	300		84	300	Variantes		20 W	50 m <sup>2</sup>	20 W	220/240 V	50/60 Hz		085826 <b>110,00</b>
	300		84	300	Panadería		20 W	50 m <sup>2</sup>	20 W	220/240 V	50/60 Hz		085828 <b>110,00</b>
	300		84	300	Pescadería		20 W	50 m <sup>2</sup>	20 W	220/240 V	50/60 Hz	1,09	085829 <b>110,00</b>

## Atrapador de insectos Tephri Trap

Tephri Trap insect trap  
Piège à insectes Tephri Trap



**Characteristics:**  
Insect trap provided with four holes to increase the flow of the attractant lure  
Versatile since it can operate in dry mode by means of attractant patches or in wet mode by means of hydrolyzed proteins (Nulure, Buminal, etc.) Capacity: 400 cc.

**Caractéristiques:**  
Piège à insectes avec 4 trous pour augmenter le flux des insectes appâtes  
Versatile puisqu'on peut l'utiliser en sec avec des patchs et en humide avec des protéines hydrolysées -Capacité 400 cc.

### Características:

Atrapador de insectos con cuatro agujeros para aumentar el flujo de los atrayentes  
Versátil, puesto que puede trabajar en seco mediante parches atrayentes y en húmedo mediante proteínas hidrolizadas (Nulure, Buminal, etc). Capacidad 400 cc.

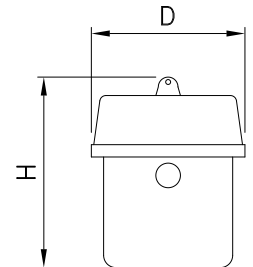

D	H	Gr	Barcode	€
125	155	136	485802	<b>8,00</b>

## Atrapador de insectos Easy Trap

Easy Trap insect trap  
Piège à insectes Easy Trap



### Características:

Fácil manejo, posibilidad de trabajar en seco y en húmedo. Gran eficacia.  
Diseñado especialmente para atrapar todas las moscas de las frutas (Ceratitis, Bactrocera, Ragholetis, Anastrepha, etc.), pero puede atrapar otros muchos insectos si se usa con los atrayentes adecuados (por ej. Drosophilas, moscardas y avispa).  
Revolucionario diseño que permite una óptima dispersión de los atrayentes de su interior y un dispositivo seguro de retención de los insectos.  
Facilidad para ser colgado por su percha adaptable.

**Caractéristiques:**  
Facile usage, possibilité d'utiliser en sec ou en humide, Grande efficacité  
Conçu pour attraper spécialement toutes les mouches (Ceratitis, Bactrocera, Ragholetis, Anastrepha, etc) mais peut également attraper d'autres insectes si on l'utilise avec les appâtes appropriés (par ex. Drosophilas, moscardas et guêpes)  
Révolutionnaire design qui permet une dispersion optimum des appâtes en son intérieur et un dispositif sûr de retenue des insectes  
S'accroche facilement grâce à son crochet adaptable

**Characteristics:**  
Easy to use. Two operating modes: dry and wet. High efficiency.  
Designed to catch fruit flies (Ceratitis, Bactrocera, Ragholetis, Anastrepha, etc.) In addition, if the adequate attractant lures are used, it can also trap many other insects such as drosophilas, blow flies and wasps.  
State of the art design for an optimal spreading of the attractant lures outwards with an insect retention security device  
Its adaptable sling bar makes it easy to hang.

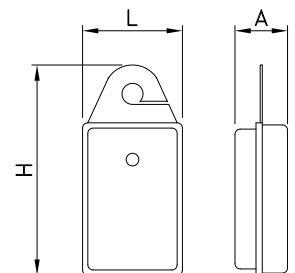

L	A	H	Gr	Barcode	€
95	50	200	56	485804	<b>6,00</b>

## Relación de repuestos para exterminadores de insectos

List of spares for insect killers

Liste de pièces de rechange pour destructeurs d'insectes











	Modelo Model Modèle		Bombilla / Tubo Light bulb Ampoule	Trampas adhesivas Adhesive traps Trappes adhésives	Estárter Starter / Choke Starter
485808	UK-50 LED		 485868		 485870
485810	UK-100 LED		 485868		 485870
485812	UK-240 LED		 485868		 485870
485838	UL		 485860	 485872	 448516
485805	MR LED		 485868	 485898	
485806	SP-80 LED		 485874	 485852	 485871
485834	LD120		 485863		
0858xx	BCxx		 485886	 485880	



## Repuestos para exterminadores de insectos

Spares for insect exterminators









Recharges pour exterminateurs d'insectes

		Unidades por caja Box units Unités par boîte		€
	20 W - Luz negra (E27 x 160) 20 W - Black light (E27 x 160) 20 W - Lumière noire (E27 x 160)	1	485886	<b>13,00</b>
	10 W - Luz LED blanca (E27 x 135) 10 W - White LED light (E27 x 135) 10 W - Lumière blanche LED (E27 x 135)	1	485887	<b>17,00</b>
	18 W - UV-A LED repuesto para exterminador LD120 UV-A LED 18 W for LD120 exterminator UV-A LED 18 W pièce de rechange pour tue-mouches LD120	1	485863	<b>11,00</b>
	7 W - Bombilla UV-A LED repuesto para exterminadores LED Spare bulb UV-A LED 7W for LED exterminators Ampoule UV-A LED 7W pièce de rechange pour tue-mouches LED	1	485868	<b>22,00</b>
	8 W - UV-A LED repuesto para exterminador SP-80 LED UV-A LED 8 W for LED SP-80 exterminator UV-A LED 8 W pièce de rechange pour tue-mouches SP-80 LED	1	485874	<b>14,00</b>
	Tubo 8 W	1	485856	<b>7,00</b>
	Tubo 11 W	1	485857	<b>9,00</b>
	Tubo 15 W	1	485858	<b>12,00</b>
	Tubo 15 W	1	485860	<b>12,00</b>
	Tubo 40 W	1	485866	<b>11,55</b>
	Tubo 18 W	1	485862	<b>18,00</b>
	Estarter para 15 W Starter / Choke for 15 W Starter pour 15 W	1	448516	<b>4,20</b>
	Estarter para 30 W Starter / Choke for 30 W Starter pour 30 W	1	448518	<b>5,30</b>
	Balasto (Reactancia) para UK-40 y UK-80 Reactance / Ballast for UK-40 & UK-80 Réactance pour UK-40 et UK-80	1	485820	<b>16,00</b>
	Balasto (Reactancia) para UK-240 Reactance / Ballast for UK-240 Réactance pour UK-240	1	485822	<b>17,00</b>
	Transformador 4000 V. repuesto para exterminadores LED Spare convert 4000 V. for LED exterminators Transformateur 4000 V. pièce de rechange pour tue-mouches LED	1	485870	<b>28,50</b>
	Transformador repuesto para exterminador SP-80 LED Spare convert for SP-80 LED exterminator Transformateur pièce de rechange pour tue-mouches SP-80 LED	1	485871	<b>18,00</b>

## Repuestos para exterminadores de insectos

Spares for insect exterminators







Recharges pour exterminateurs d'insectes

		Unidades por caja Box units Unités par boîte			
					€
	Trampas adhesivas para SP-80 (395x300 mm.) Adhesive traps for SP-80 (395x300 mm.) Trappes adhésives pour SP-80 (395x300 mm.)	6		485852	<b>39,00</b>
	Trampas adhesivas para V-30 Adhesive traps for V-30 Trappes adhésives pour V-30	6		485855	<b>4,00</b>
	Trampas adhesivas para UL-80 (450x290 mm.) Adhesive traps for UL-80 (450x290 mm.) Trappes adhésives pour UL-80 (450x290 mm.)	6		485872	<b>35,00</b>
	Trampas adhesivas para MR-40 (460x175 mm.) Adhesive traps for MR-40 (460x175 mm.) Trappes adhésives pour MR-40 (460x175 mm.)	5		485898	<b>30,00</b>
	Trampas adhesivas para MR-70 Adhesive traps for MR-70 Trappes adhésives pour MR-70	6		485897	<b>34,00</b>
	Trampas adhesivas Adhesive traps Trappes adhésives	6		485880	<b>19,00</b>

## Repuestos para exterminadores de insectos

Spares for insect exterminators

Recharges pour exterminateurs d'insectes

		Tensión Voltage Tension	Frecuencia Frequency Fréquence					€
	Enchufe con mando a distancia Remote controlled RF socket Connectez avec télécommande	240V	50 Hz	30 mts.	A23-12v	215	485892	<b>19,00</b>
	Adaptador enchufe tipo H Type H plug adapter Adaptateur pour prise électrique type H	220V	50 Hz			56	485878	<b>8,00</b>

## Contenedor de desperdicios con tapa y ruedas

Waste bin with lid and wheels

Conteneur à ordures avec couvercle et roulettes

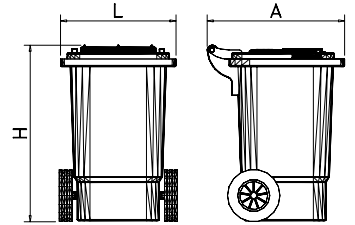

L	A	H	Capacity	Weight	Color	Barcode	Price (€)
470	550	670	60 lts	8,75	Grey	486002	<b>82,00</b>
					Green	486042	
					Blue	486038	
					Yellow	486040	
					Brown	486044	
470	550	925	120 lts	10,50	Grey	486046	<b>92,00</b>
					Blue	486034	
					Green	486032	
					Yellow	486036	
					Brown	486030	
580	740	1.070	240 lts	14,50	Grey	486035	<b>158,00</b>
					Blue	486084	
					Green	486082	
					Yellow	486086	
					Brown	486080	
					Red	486088	

### Características:

Ampliamente resistentes al calentamiento, a las heladas y a los productos químicos.

### Characteristics:

Highly resistant to heat, extreme cold and chemical products.

### Caractéristiques:

Très résistant aux hautes températures, aux gelées et aux produits chimiques.



L	A	Capacity	Weight	Color	Barcode	Price (€)	
470	550	60 lts 120 lts	230	Grey	486090	<b>38,00</b>	
				Green	486091		
				Blue	486092		
				Yellow	486093		
				Brown	486094		
580	740	240 lts	300	Grey	486099	<b>45,00</b>	
				Green	486120		
				Blue	486122		
				Yellow	486124		
				Brown	486126		
					Yellow	486128	

Capacity	Barcode	Price (€)
Pedal opcional Optional pedal Pédale en option	60 lts 486050	<b>38,50</b>
Pedal opcional Optional pedal Pédale en option	120 lts 486060	<b>38,50</b>
Pedal opcional Optional pedal Pédale en option	240 lts 486061	<b>38,50</b>



Capacity	Weight	Barcode	Price (€)
60 lts 120 lts 240 lts	680	486096	<b>39,00</b>
60 lts 120 lts	110	486097	<b>21,00</b>
240 lts	150	486098	<b>27,00</b>

El precio es por pareja.  
The pair is included in the price.  
Le paire est inclus dans de prix.

### Contenedor de desperdicios

Waste bin  
Conteneur à ordures

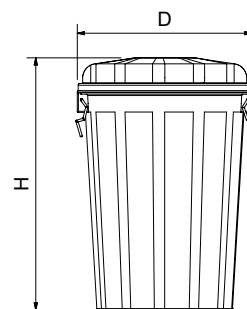

H	D		Kg		€
600	455	70 lts	2,5	486023	<b>20,00</b>
730	495	95 lts	3,0	486022	<b>31,00</b>

### Contenedor inoxidable con tapa

Stainless container with lid  
Conteneur inoxydable avec couvercle

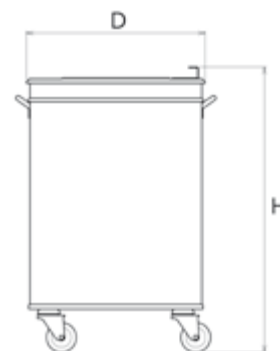

H	H1	D		Kg		€
600	530	380	50 lts	7,10	486004	<b>187,00</b>

### Contenedor inoxidable con tapa de apertura a pedal

Pedal operated stainless container with lid  
Conteneur inoxydable avec couvercle à pédale

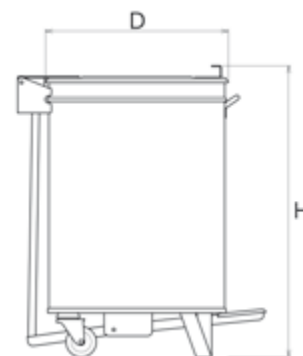

H	H1	D		Kg		€
605	540	450	75 lts	12,25	486006	<b>248,00</b>

### Contenedor porta-bolsas con tapa y ruedas

Bag-holder container with lid and wheels  
Conteneur porte-sacs avec couvercle et rouelles

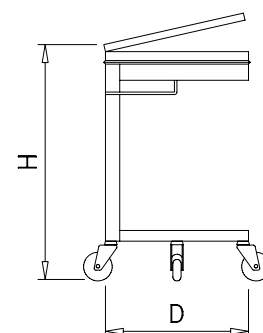

D	H	Kg		€
450	850	3,25	486010	<b>235,00</b>

### Contenedor porta-bolsas sistema "tijera", apertura a pedal

Pedal operated folding system bag-holder container  
Conteneur porte sacs système pliant à pédale

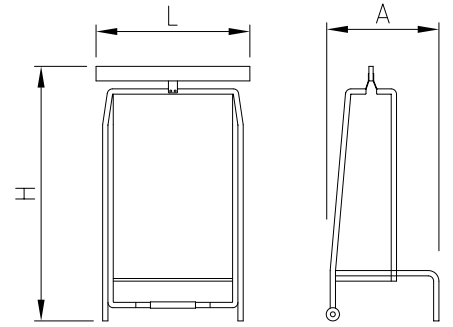

L	A	H	Kg	Barcode	€
470	570	1.000	6,65	486020	<b>145,00</b>

### Contenedor inoxidable con tapa y ruedas especial panadería

Stainless steel dustbin with lid and wheels. Special for bakery  
Poubelle inoxydable avec couvercle et rouelles. Spécial pour boulangerie

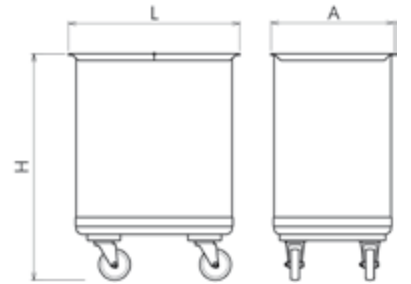

L	A	H	Capacity	Kg	Barcode	€
610	395	725	115 lts	19,00	486008	<b>470,00</b>

### Papelera con tapa y ruedas 70 lt

Container with lid and wheels 70 l.  
Poubelle avec couvercle et roulettes 70 lt



#### Características:

Fabricada en acero inoxidable acabado brillo.

#### Characteristics:

Made out of stainless steel, polished finishing.

#### Caractéristiques:

Fabriquée en acier inoxydable finition brillante.

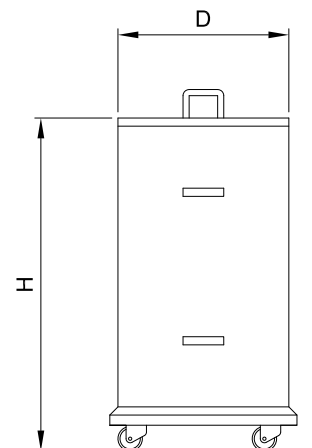

D	H	Capacity	Kg	Barcode	€
420	730	70 lts	10,50	486076	<b>242,00</b>

## Contenedor inox para vaciado de bandejas de comida rápida fast-food

Stainless steel waste bin for fast food restaurants

Poubelle en acier inoxydable spéciale snack restauration rapide Fast-food



Apertura a pedal  
Foot pedal opening  
Ouverture à pédale



080662

080660



### Características de fabricación:

Fabricado totalmente con acero inoxidable. Sistema patentado de pedal. Permitirá al usuario abrir la trampilla sin necesidad de usar las manos. La trampilla también se puede abrir con la mano en caso de requerirlo. Las varillas de la parte superior del mueble facilitan la colocación de las bandejas. La tolva de caída de los desperdicios es de una sola pieza y no posee juntas ni huecos, lo que facilita la limpieza. Asa de la puerta ergonómica. El contenedor posee dos ruedas, lo que permite desplazarlo con poco esfuerzo. Provisto de dos tacos regulables en altura para adaptarse a cualquier clase de suelo, evitando desplazamientos accidentales o no deseados. Insonorizado en todas sus piezas.

### Manufacturing characteristics:

Fully made of stainless steel. Pedal operated patented system. It will allow the user to open the lid avoiding the use of his hands. The lid can also be opened with the hand if necessary. Rods on the top that make easier the placing of the empty trays. Receptacle for scraps made in one only piece, without joints or hollows. Ergonomic handle. It can be moved effortlessly by means of two wheels. It can be adapted to any floor unevenness thanks to two adjustable blocks. All its components are soundproofed.



486074 36,00 393

Contenedor de plástico con tapa 55 lts

Plastic bin with lid 55 lts  
Conteneur 55 lts



480662 19,00

Adhesivo trampilla  
Sticker for lid  
Autocollant pour trappe



486022 31,00 386

Contenedor de desperdicios 95 lts  
Waste bin 95 lts  
Conteneur à ordures 95 lts



480664 19,00

Adhesivo para pedal  
Sticker for pedal  
Autocollant pour pédale



485016 4,00

Ruedas  
Wheels  
Rouelles



- Incluido** / Included / Inclus
- Opcional** / Optional / Optionnel

**Caractéristiques de fabrication:**  
Fabricado totalmente en acero inoxidable. Sistema patentado de pedal. Permitirá al usuario abrir la trampilla sin necesidad de utilizar las manos. La trampilla puede también ser abierta con las manos en caso de requerirlo. Las varillas de la parte superior del mueble facilitan el almacenamiento de bandejas. La tolva de residuos está construida en una sola pieza y no posee juntas, lo que facilita el mantenimiento. Tirador ergonómico. La poubelle tiene dos ruedas, lo que permite moverla con poco esfuerzo. Está equipada con dos tacos regulables en altura para adaptarse a cualquier tipo de suelo, evitando desplazamientos accidentales o no deseados. Toda la poubelle está insonorizada.

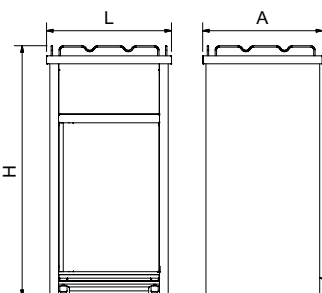

L	A	H	litros	Kg	Barcode	€
625	600	1.255	95 lt	46,0	080660	<b>1.150,00</b>
540	410	1.016	55 lt	30,5	080662	<b>1.000,00</b>

## Mesa mural desbarasado y reciclaje con puerta

Waste and recycling wall-side table

Table murale pour trémie à déchets et recyclage



### Características:

Laterales forrados en acero inoxidable.  
Aro para tolva de desbarasado color azul.  
Tapa para aro.

### Characteristics:

Sides covered with stainless steel panels.  
Blue ring for waste chutes.  
Ring lid.

### Caractéristiques:

Latérales recouvertes en acier inoxydable.  
Cercle bleu pour trémies à déchets.  
Couvercle.

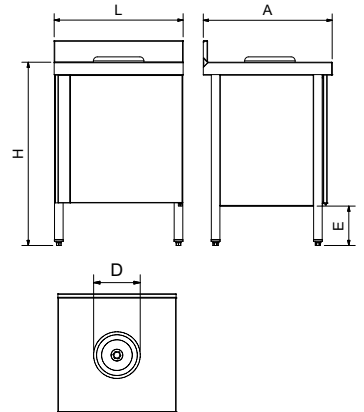

L	A	H	D	E	Kg	Barcode	€
600	600	850	235	200	23	074438	<b>601,00</b>
600	700	850	235	200	28	074437	<b>800,00</b>

## Contenedor de desperdicios y reciclaje

Waste and recycling container

Conteneur à ordures et recyclage

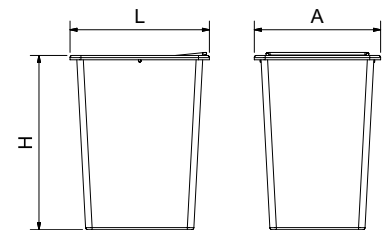

L	A	H	Capacity	Color	Gr	Barcode	€
315	285	380	26 lts	Blue	400	486024	<b>24,00</b>
				Green		486026	
				Yellow		486028	
				Grey		486025	

## Centro de reciclado 4 elementos

Quadruple recycling station 4 elements recycler

Centre de recyclage de quatre éléments

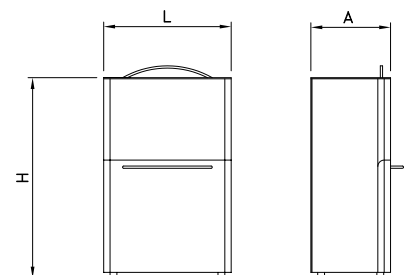

L	A	H	Capacity	Kg	Barcode	€
560	350	880	72 lts	18,0	486068	<b>550,00</b>

**Papelera de reciclaje**  
 Recycling bin  
 Poubelle de recyclage

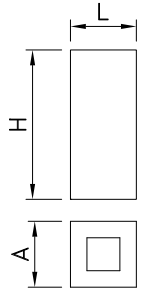

L	A	H	Icon	Kg	Barcode	€
300	300	680	58 lts	6,80	486104	<b>228,00</b>
					486106	
					486108	
					486110	

**Contenedor para reciclado**  
 Recycling container  
 Récipient pour le recyclage

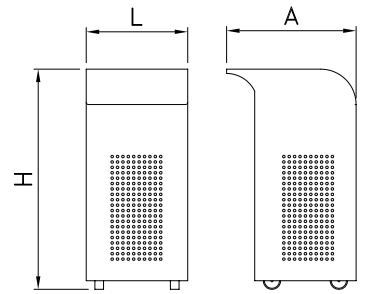

L	A	H	Icon	Kg	Barcode	€
470	600	1.020	270 lts.	28,0	486062	<b>795,00</b>
					486064	
					486066	

**Contenedor de desperdicios 80L serie GO**  
 Waste bins 80L GO series  
 Conteneur à déchets 80L série GO

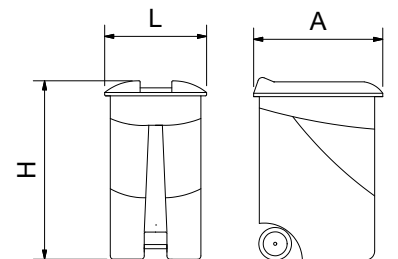

L	A	H	Icon	Kg	Barcode	€
400	575	785	80 lts.	3,34	486150	<b>65,00</b>
					486152	
					486154	
					486156	



## Contenedor de reciclaje vertical

Vertical recycling waste bin station  
Conteneur de recyclage vertical



Wholly made in stainless steel AISI 304, it has been designed for a selective collection of waste products. Its column-shape design allows you to get a better use of space in working areas.

It is composed of a front door with four lids provided with an automatic shutting that leads to the different inner containers. Total capacity of 104 litres divided into four tight compartments of 26 litres each one.

With declined roof to avoid dirtiness deposits. Its free space underneath enables an easy cleaning.

Originally it is designed to lodge different kind of waste products:

- Paper and paperboard.
- Cans and plastic containers.
- Glass bottles
- Trash.

Later on you will be able to make your own configuration by means of the rubber ring for wastes and stickers available according to the products you need to recycle.

Faites entièrement en acier inox AISI 304, il a été conçu pour une collecte sélective des déchets. Dessiné en forme de colonne pour une meilleure utilisation de l'espace dans les zones de travail.

Porte frontale avec quatre trappes munies de fermeture automatique. Chaque trappe donne accès à un conteneur différent.

Capacité totale de 104 litres divisé en quatre compartiments de 26 litres chacun.

Avec toit incliné pour éviter les dépôts de saleté. Son espace libre en dessous permet un nettoyage facile.

A l'origine il est destiné à loger des différents types de déchets:

- Papiers et cartons.
- Récipient en plastique.
- Bouteilles en verre
- Des ordures.

Postérieurement vous pourrez faire votre propre configuration à l'aide de la bague en caoutchouc pour les déchets et les autocollants disponibles selon les produits dont vous avez besoin de recycler.

Recipientes interiores estancos, independientes y extraíbles de 26 lts de capacidad fabricados en plástico 100 % reciclable. Disponen de asas para su fácil manipulación.

It is provided with detachable tight containers of 26 litres of capacity, made of plastic 100% recyclable and with handles for an easy handling.

Il est fourni avec conteneurs étanches détachables de 26 litres de capacité, fabriqués en plastique 100% recyclables et avec des poignées pour une manipulation facile.

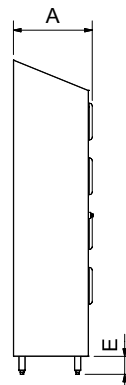
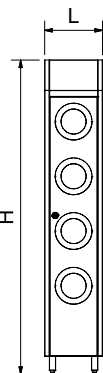

Gestione sus residuos de una manera eficaz, ocupando el menor espacio posible.

Su construcción en acero inoxidable permite su ubicación en exteriores.

Ideal en cocinas, vestuarios, oficinas, instalaciones deportivas, etc.

Manage your waste products efficiently while optimizing room.

It is made of stainless steel, which allows to be installed at any outdoor space.

Ideal for kitchens, dressing-rooms, offices, sport facilities, etc.

Organisez vos déchets avec efficacité et optimisez votre espace.

Il est fabriqué en acier inoxydable, ce qui permet son installation à tout espace extérieur.

Idéal pour salles de cuisines, dressing-rooms, bureaux, installations sportives, etc.

Armario fabricado totalmente en acero inoxidable, concebido para la recogida selectiva de residuos. Mejor aprovechamiento del espacio en el entorno de trabajo gracias a su diseño en modo de columna.

Formado por una puerta frontal con cuatro trampillas provistas de cierre automático, que dan acceso a los diferentes contenedores interiores.

104 litros de capacidad total repartida en cuatro contenedores de 26 lts cada uno.

Techo inclinado para evitar depósitos de suciedad, el espacio inferior libre permite limpiar debajo del mueble. En su configuración estándar está preparado para reciclar:

- Papel y cartón.
- Envases.
- Materia orgánica, basura general.
- Vidrio.

Posteriormente usted podrá personalizar su contenedor mediante aros y adhesivos en función de los residuos que desee reciclar.









L	A	H	E	Kg	Barcode	€
370	505	2.010	120	33	081440	998,00

## Repuestos para contenedor de reciclaje vertical

Spare parts for vertical recycling waste bin

Pièces de remplacement pour conteneur de recyclage vertical

		Gr	€				
	<b>Adhesivo reciclar Papel y cartón</b> Paper and paperboard recycling sticker Autocollant recyclage de papier et carton		481420 <b>27,00</b>				
	<b>Adhesivo reciclar Materia orgánica</b> Trash recycling sticker Autocollant recyclage des ordures		481422 <b>27,00</b>				
	<b>Adhesivo reciclar Envases y plásticos</b> Cans and plastic containers recycling sticker Autocollant recyclage récipients en plastique		481424 <b>27,00</b>				
	<b>Adhesivo reciclar Vidrio</b> Glass bottles recycling sticker Autocollant recyclage de bouteilles en verre		481426 <b>27,00</b>				
	<b>Adhesivo Reciclaje</b> Recycling sticker Autocollant recyclage		481428 <b>27,00</b>				
	<b>Aro azul con trampilla para contenedor de reciclaje vertical</b> Blue ring with self-closing trap for recycling waste bin Cercle bleu avec trappe battante pour conteneur de recyclage	750	<table border="1"> <tr><td>081442</td></tr> <tr><td>081444</td></tr> <tr><td>081446</td></tr> <tr><td>081448</td></tr> </table> <b>48,00</b>	081442	081444	081446	081448
081442							
081444							
081446							
081448							

## Papelera inox de 70 lt apertura frontal

Inox wastepaper bin 70 litres, front opening

Corbeille à papier inox 70 litres, ouverture frontale

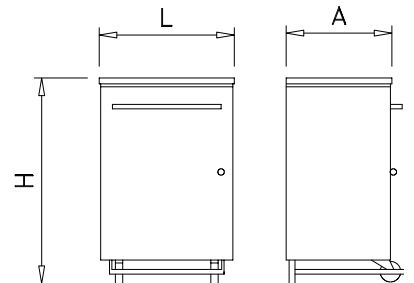

L	A	H	Kg	€
370	470	715	7,0	486070 <b>396,00</b>

## Papelera basculante en acero inoxidable

Stainless steel toggling wastebin

Conteneur basculant en acier inox



### Características:

Construida totalmente en acero inoxidable. Fácil apertura para su carga y descarga, tan solo levantando su caperuza superior.

### Characteristics:

Totally made of stainless steel. Easy opening for charge and discharge, by only lifting the upper cover.

### Caractéristiques:

Fait tout en acier inox. Facile ouverture pour le charger et le décharger, seulement en levant la couverture supérieure.

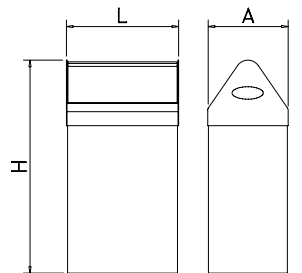



Apertura Opening Ouverture	L	A	H	Kg	€
Manual Manual Manuel	350	250	680	44 lts	6,85 080604 <b>270,00</b>
Pedal opcional Optional pedal Pédale optionel				0,4	080606 <b>46,00</b>

## Repuestos para contenedores inoxidables

Spare for inox-dustbin

Rechangements pour poubelles

	Modelos Models Modèles	Gr	Barcode	€
 <p>Rueda repuesto para contenedores inox Spare wheel for stainless steel dustbin Rouelle de rechange pour poubelle inoxydable</p>	486004	120	486052	<b>10,00</b>
	486006			
	486008	30	486054	<b>20,00</b>
		50	486058	<b>7,00</b>
 <p>Goma de repuesto para contenedor porta-bolsas Spare rubber for bag-holder container Caoutchouc de rechange conteneteur porte-sacs</p>	486010	35	486056	<b>14,00</b>

## Papelera de plástico con pedal

Plastic bin with pedal

Poubelle en plastique avec pédale

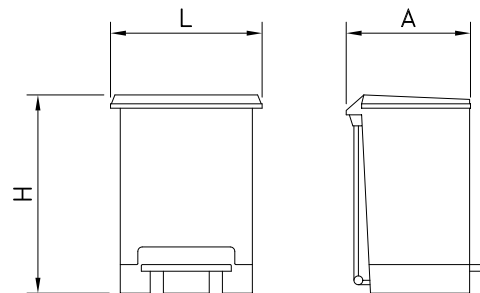

L	A	H	Gr	Barcode	€
330	270	450	26 lbs	1,80	486072 <b>20,00</b>

## Contenedor higiénico sanitario con apertura a pedal

Pedal operated sanitary bin

Poubelle hygiénique sanitaire à pédale



### Características:

Unidad diseñada exclusivamente para la recogida de residuos como compresas, tampones y pañales. Construidos en ABS color blanco, cuentan con pedal y tapa basculante integrados, además de cabezal reversible.

### Characteristics:

Specially designed for waste collection such as pads, tampons and diapers. Made of white ABS, with integrated pedal, swing top lid and masking tray.

### Caractéristiques:

Spécialement conçu pour la collecte des déchets tels que tampons, serviettes-hygiéniques et couches. Fabriqué en ABS blanc, avec pédale intégrée, couvercle pivotant supérieur et vanne de masquage.

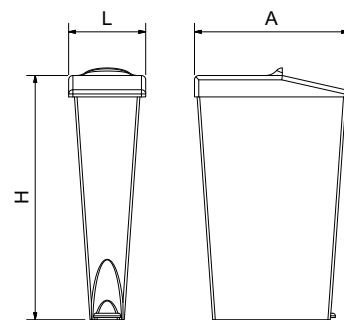

L	A	H	Gr	Barcode	€
180	360	570	18 lbs	1,80	460248 <b>43,00</b>

## Contenedor de plástico con tapa 55 litros

Plastic bin with lid 55 liters

Conteneur 55 lts

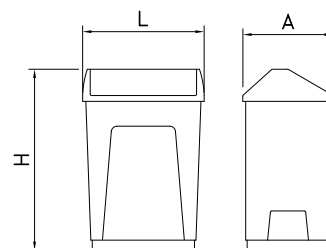

L	A	H	Gr	Barcode	€
415	320	620	55 lbs	3,0	486074 <b>36,00</b>

**Cubo pedal baño con papelera interior**  
 Pedal bin for toilet  
 Poubelle sale de bains

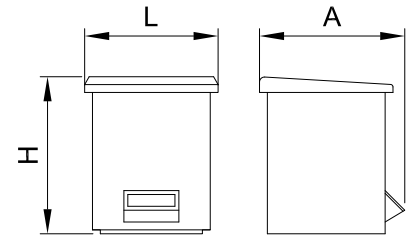

L	A	H				€
270	230	280	8	809	486112	<b>18,00</b>

**Papelera**  
 Wastepaper bin  
 Corbeille à papiers

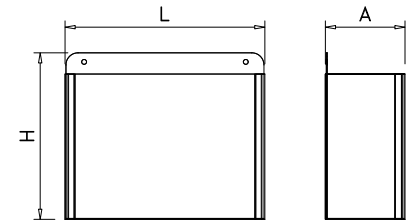

L	A	H				€
330	130	275	11 lts	2,20	080602	<b>55,00</b>

**Papelera modelo Design**  
 Design model wastepaper bin  
 Corbeille à papiers modèle Dèsign

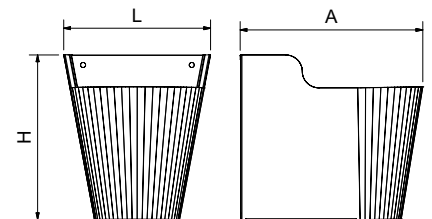

L	A	H				€
340	265	300	18 lts	2,3	080608	<b>77,00</b>

**Papelera con tapa y pedal**  
 Pedal operated wastepaper bin with lid  
 Corbeille à papiers avec couvercle et pédale

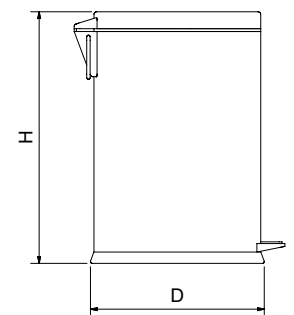

D	H				€
200	310	5 lts	2,0	486012	<b>25,00</b>
250	390	12 lts	3,9	486014	<b>39,00</b>
290	650	30 lts	5,9	486016	<b>86,00</b>

## Dispensador de bolsas

Whole dispenser for plastic bags  
Conjoint dispensateur de sacs

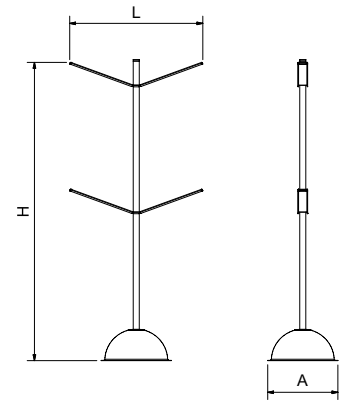

L	A	H	Kg	Barcode	€
550	290	1.245	9,0	080426	<b>162,00</b>

## Conjunto dispensador de guantes y bolsas en rollo

Dispensing unit for gloves and snappy bags in roll  
Conjoint dispensateur de gants et sacs en roulot



### Características:

El conjunto y sus complementos cumplen con toda la normativa aplicable al respecto de la Unión Europea. Dispensador de guantes que, por separado, admite colocación de sobremesa. Dispensador de bolsas de hasta 370 mm. de longitud, semi-hermético, que, por separado, admite colocación a pared. Soporte para dispensadores y papeleras, construido específicamente para favorecer la estabilidad y la higiene.

### Characteristics:

The whole and its items obey with all the applicable norms from the European Union and the Spanish state. Gloves dispenser, that separately, it admits to be put in table. Plastic bags dispenser of 370 length maximum, semi-hermetic, that separately it admits to be put in wall. Dispensers and wastebins support, made specifically to improve the stability and the hygiene. Wastebin. Totally made in stainless steel.

### Caractéristiques:

Le conjoint et ses compléments obéissent avec les normes applicables de la Union Européenne et l'Etat Espagnol. Dispensateur de gants, que par séparé, admet d'être placé sur table. Dispensateur de sacs jusqu'à 370 mm de longueur, semi-hermétique, que par séparé, admet d'être placé sur mur. Support pour dispensateurs et conteneurs, fait spécifiquement pour favoriser l'estabilité et l'hygiène.

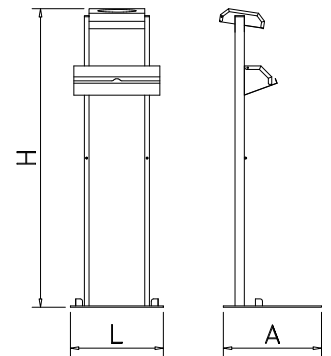

L	A	H	Kg	Barcode	€
422	365	1.290	9,6	080402	<b>270,00</b>

## Conjunto dispensador de guantes y bolsas colgantes

Dispensing unit for gloves and snappy hanging flat bags  
Conjoint dispensateur de gants et sacs suspendus



### Características:

El conjunto y sus complementos cumplen con toda la normativa aplicable al respecto de la Unión Europea y del Estado Español. Dispensador de guantes que por separado, admite colocación de sobremesa. Soporte para dispensadores y papeleras, construido específicamente para favorecer la estabilidad y la higiene.

### Characteristics:

The whole and its items comply with all the applicable norms from the European Union and the Spanish state. Gloves dispenser, that separately, it admits to be put in table. Dispensers and wastebins support, made specifically to improve the stability and the hygiene.

### Caractéristiques:

Le conjoint et ses compléments obéissent avec les normes applicables de la Union Européenne et l'Etat Espagnol. Dispensateur de gants, que par séparé, admet d'être placé sur table. Support pour dispensateurs et conteneurs, fait spécifiquement pour favoriser l'estabilité et l'hygiène.

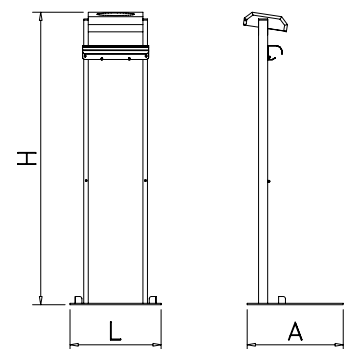

L	A	H	Kg	Barcode	€
422	365	1.290	8,5	080412	<b>245,00</b>

## Conjuntos dispensadores de guantes y bolsas con papeleras

Dispensing unit for gloves and snappy bags with wastebins

Conjoints dispensateurs de gants et sacs avec conteneurs



€

Con papelera adosada  
With joint wastebin  
Avec conteneur adossé

990140102 **325,00**



Apertura  
Opening  
Ouverture



€

Manual  
Manual  
Manuel

990140202 **540,00**

Con papelera basculante  
With toggling wastebin  
Avec conteneur basculant

Con pedal  
With pedal  
Avec pédale

990140601 **586,00**



€

Con papelera adosada  
With joint wastebin  
Avec conteneur adossé

990140302 **300,00**



Apertura  
Opening  
Ouverture



€

Manual  
Manual  
Manuel

990140402 **515,00**

Con papelera basculante  
With toggling wastebin  
Avec conteneur basculant

Con pedal  
With pedal  
Avec pédale

990140701 **561,00**

**Dispensador de guantes**  
 Gloves dispenser  
 Distributeur de gants



**Características:**

Construidos totalmente en acero inoxidable acabado satinado. La colocación del dispensador puede ser mural o de sobremesa. Como dotación estándar cuentan con tacos antideslizantes para su colocación de sobremesa.

**Characteristics:**

Totally made of stainless steel. The placing of both may be on table or on wall. As standard equipment they have anti-slipping pegs for its placing on table.

**Caractéristiques:**

Construit totalement en acier inoxydable brillant. Comme équipement standar ils ont ventouses anti-glissants pour se placement sur table.

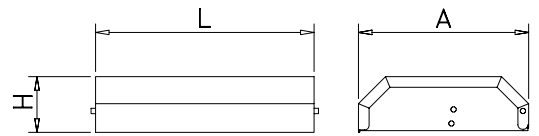

L	A	H	Gr	080404	€
270	195	65	900	080404	53,00

**Dispensador de bolsas en rollo**  
 Roll bag dispenser  
 Distributeur de sacs sur rouleau

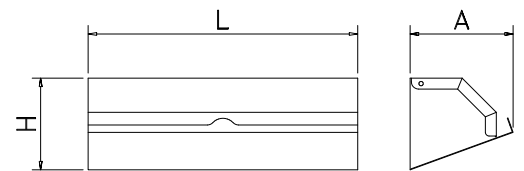

L	A	H	Kg	080406	€
375	140	125	1,25	080406	57,00

**Dispensador de bolsas colgantes**  
 Dispenser for snappy hanging flat bags  
 Distributeur de sacs suspendus



**Características:**

Distancia entre ejes regulable, para adaptarse a cualquier medida entre taladros de la bolsa.

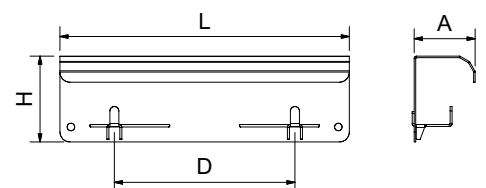

L	A	H	D	Kg	080414	€
290	61	86	90-215	0,51	080414	30,00

**Caractéristiques:**

Distance entre axes réglable afin de s'adapter à quelque mesure entre les trous du sac.

**Characteristics:**

Adjustable axle distance to adapt any measure between the bag holes.

### Dispensador mural de papel alimentario

Food paper wall dispenser  
 Dispensateur mural de papier alimentaire

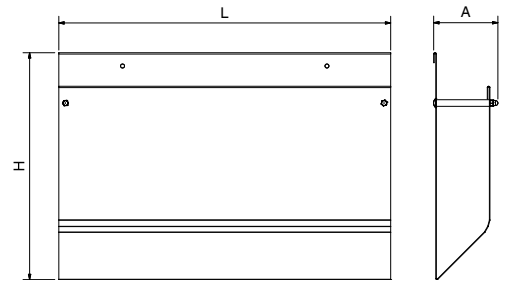

L	A	H	Kg	Barcode	€
500	85	342	2,33	080410	<b>72,00</b>

### Dispensador de bolsas para envasado de alimentos

Bag dispenser for food packaging  
 Distributeur de sacs pour emballage alimentaire

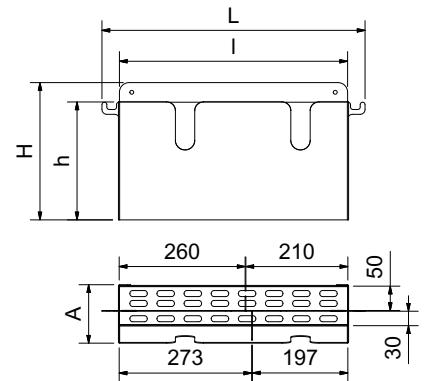

L	l	A	H	h	Kg	Barcode	€
543	471	121	283	243	5,26	080417	<b>108,00</b>

### Papelera-dispensador de bolsas de papel

Wastepaper bin and paper bags dispenser  
 Corbeille a papiers et distributeur de sacs en papier

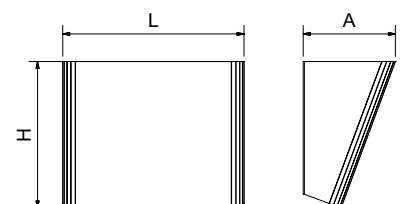

L	A	H	Kg	Barcode	€
315	160	245	1,72	080424	<b>64,00</b>



## Portarrollos dispensador de film para envolver

Roll holder dispenser for food wrapping

Porte rouleaux dévidoir pour envelopper les aliments

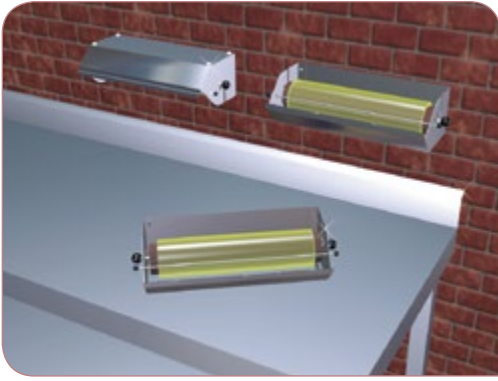

### Características:

Construidos en acero inoxidable. Válido para colocarse de las tres maneras al lado representadas. Provisto de filo dentado especial para favorecer el corte del film o papel de aluminio.

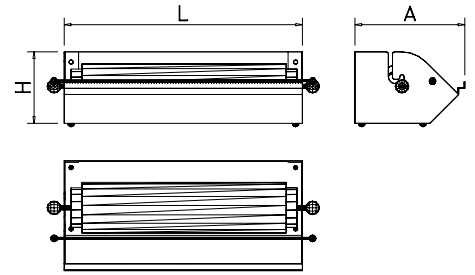

### Characteristics:

Made of stainless steel, apt for positioning in the three manners demonstrated besides, equipped with a special serrated blade for cutting plastic film or aluminium foil.

### Caractéristiques:

Fabriqués en acier inoxydable, pouvant être placés suivant les trois manières indiquées à côté, munis d'une lame à dents spéciales pour faciliter la coupe du film ou du papier d'aluminium.

L	A	H	Largo de bobina Roll length Longeur du rouleaux	Kg	Barcode	€
350	165	110	300	0,95	080202	<b>60,00</b>
500	165	110	450	1,35	080204	<b>66,00</b>

## Kits de portarrollos de papel o film

Wall mounted dispenser for rolls of food wrapping plastic

Kit de porte-rouleaux du papier ou film

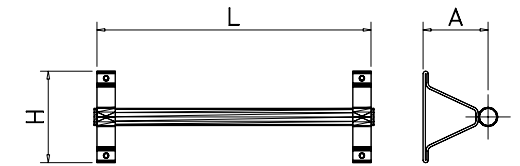

L	A	H	Largo de bobina Roll length Longeur du rouleaux	Kg	Barcode	€
450	150	200	300	2,1	080206	<b>185,00</b>
600	150	200	450	2,2	080208	<b>190,00</b>
750	150	200	600	2,3	080210	<b>200,00</b>
1.050	150	200	900	2,6	080212	<b>220,00</b>

## Kits de portarrollos de papel o film serie Eco

Eco serie paper or film roll holder kit

Kit de porte-rouleaux du papier ou film serie Eco

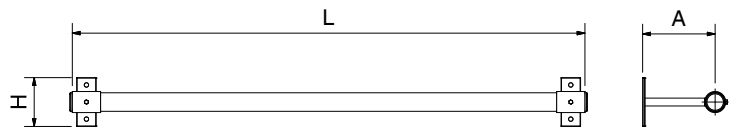

L	A	H	Largo de bobina Roll length Longeur du rouleaux	Kg	Barcode	€
450	150	100	300	1,39	080220	<b>129,00</b>
600	150	100	450	1,59	080222	<b>134,00</b>
750	150	100	600	1,80	080224	<b>137,00</b>
1.050	150	100	900	2,21	080226	<b>141,00</b>

## Kit portarrollos insonorizado para papel o film

Soundproof roll holder kit for paper or film

Kit porte-rouleau insonorisé pour papier ou film

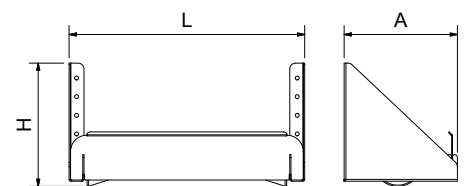

L	A	H	Largo de bobina Roll length Longeur du rouleaux	Kg	Barcode	€
390	190	207	300	1,83	080230	<b>88,00</b>
525	190	207	450	1,89	080232	<b>97,00</b>
690	190	207	600	1,97	080234	<b>106,00</b>
990	190	207	900	2,11	080236	<b>117,00</b>

## Dispensador de tissues, guantes, toallas, etc.

Tissues, towels, gloves dispenser

Dispensateur de tissus, essuie-mains, gants, etc.

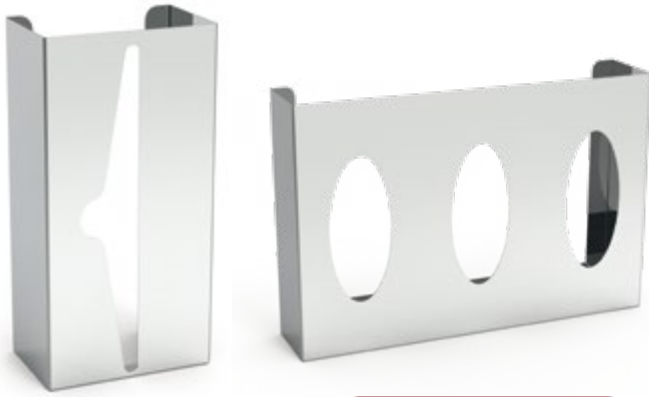

Para cajas de medidas  
Admisse box of dimensions  
Dimensions

L	A	H
120	70	230

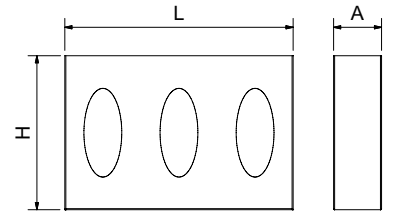

L	A	H	👤	Kg	📊	€
130	80	260	1	0,9	080418	<b>15,00</b>
386	80	260	3	2,1	080420	<b>25,00</b>

## Dispensador de mascarillas FFP2

FFP2 mask dispenser

Distributeur de masques FFP2

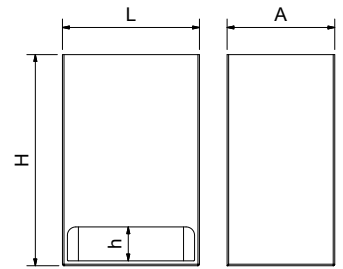

L	A	H	h	Gr	📊	€
162	127	249	40	800	080419	<b>13,50</b>

## Consumibles para dispensadores

Disposable spares for dispensers

Accessoires de rechange pour dispensateurs

	Talla Size Taille	Uds Units Units	📊	€
--	-------------------------	-----------------------	---	---



Bolsas colgantes 350x450  
Hanging bags 350x450 mm  
Sacs pendants 350x450 mm

500 480052 **15,00**



Caja de 10.000 guantes desechables (100 bolsas de 100 unidades)  
Box of 10,000 disposable gloves (100 bags of 100 units)  
Boîte de 10000 gants jetables (100 sacs de 100 unités)

Única 10000 480054 **60,00**



Caja de 10.000 guantes desechables con agujero para colgar (100 bolsas de 100 unidades)  
Box of 10,000 disposable gloves with hanging hole (100 bags of 100 units)  
Boîte de 10000 gants jetables avec trou pour suspension (100 sacs de 100 unités)

Única 10000 480055 **125,00**

**Barra de apoyo mural para lavabo**  
 Wall-side support bar for washbasin  
 Barre d'appui murale pour lavabo

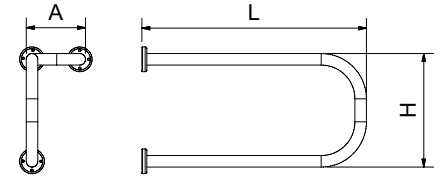

L	A	H	Kg	Barcode	€
600	185	215	1,5	481654	<b>79,00</b>

**Barra de apoyo mural para bañera**  
 Wall-side support bar for bath  
 Barre d'appui murale pour baignoire

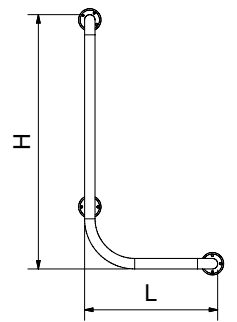

L	H	Kg	Barcode	€
400	800	1,33	481658	<b>70,00</b>

**Barra de apoyo recta**  
 Grab bar  
 Barre d'appui droit

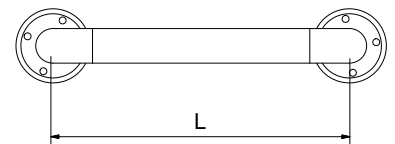

L	Gr	Barcode	€
300	450	481660	<b>25,00</b>
600	600	481662	<b>30,00</b>
900	900	481664	<b>35,00</b>

**Barra de apoyo mural vertical abatible**  
 Vertical wall-side hinged support bar  
 Barre d'appui murale verticale battante

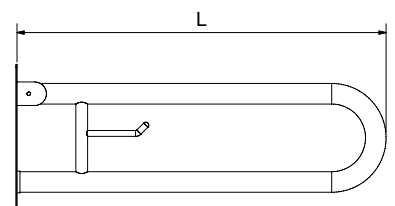

L	Kg	Barcode	€
600	2,35	481666	<b>57,00</b>



**Barra de apoyo abatible. Anclaje a suelo**  
 Floor-mounted hinged support bar  
 Barre d'appui battante ancrage au sol

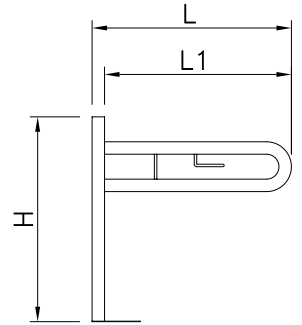

L	H	L1	Kg	Barcode	€
760	740	710	2,90	481670	<b>120,00</b>

**Barra de apoyo mural horizontal**  
 Horizontal wall-side support bar  
 Barre d'appui murale horizontale

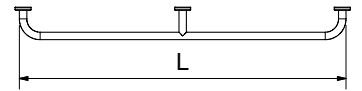

L	Kg	Barcode	€
1.050	1,66	481650	<b>55,00</b>

**Barra de apoyo mural horizontal pasamanos**  
 Horizontal wall-side handrail support bar  
 Barre d'appui murale horizontale main courante

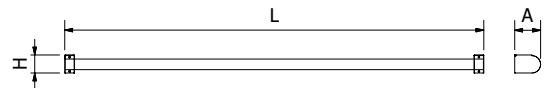

L	A	H	Kg	Barcode	€
2.000	93	65	3,75	083202	<b>79,00</b>

**Asiento abatible**  
 Hinged seat  
 Siège abattable

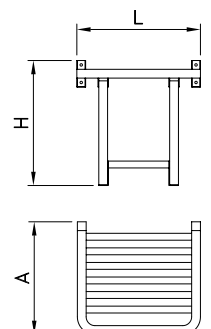

L	A	H	Kg	Barcode	€
460	440	25	3,20	481672	<b>110,00</b>

## Lavaojos mural de emergencia en acero inoxidable

Stainless steel wall-mounted emergency eyes-bath  
Lave-yeux mural d'urgence en acier inoxydable



### Características:

Los lavaojos de emergencia ofrecen instantáneamente agua como primera ayuda.

Los lavaojos con dos rociadores y recogedor en ACERO INOXIDABLE, ofrecen un gran caudal de agua aireada a baja presión, que baña la cara y los ojos, sin dañar los delicados tejidos oculares.

### Characteristics:

Our emergency eyes baths offers you an instantly first aid of water.

Our eye baths, with twin sprayer and stainless steel bowl provide a high flow of low pressure aired water that washes face and eyes without any damage for the delicate eyes tissue.

### Caractéristiques:

Nos lave-yeux muraux d'urgence vous offre une aide instantané d'eau.

Nos lave-yeux, avec deux têtes d'aspersion et avec vasque en acier inoxydable, procurent un grand débit d'eau aérée à basse pression pour le lavage des yeux et du visage sans endommager les sensibles tissus oculaires.



Con cada aparato, se entrega un rótulo para señalar la unidad.  
Every appliance is delivered with a label to mark the unit.  
Chaque appareil c'est fourni avec une étiquette pour marquer l'unité.

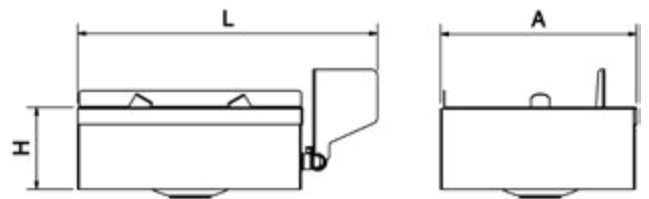

L	A	H	Kg	Barcode	€
469	305	127	5,0	064620	<b>414,00</b>

## Ducha mural de emergencia

Wall-mounted emergency shower  
Douche d'urgence murale



Con cada aparato, se entrega un rótulo para señalar la unidad.  
Every appliance is delivered with a label to mark the unit.  
Chaque appareil c'est fourni avec une étiquette pour marquer l'unité.

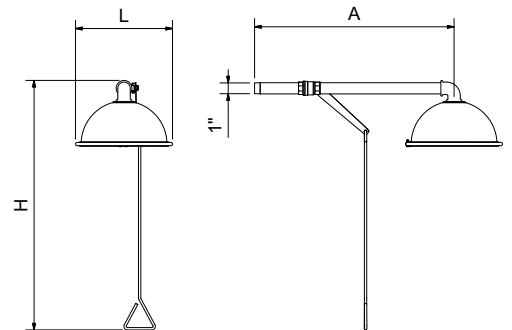

L	A	H	Kg	Barcode	€
294	605	756	2,6	064630	<b>253,00</b>

## Lavabotas manual en acero inoxidable

Manual stainless steel boot washer  
Lave-bottes manuel en acier inoxydable

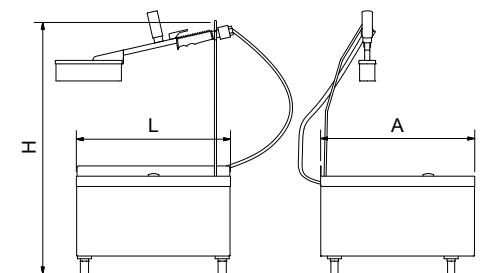

L	A	H	Kg	Barcode	€
450	450	740	7,50	064802	<b>399,00</b>



**Armario botiquín**  
Medicine chest  
Armoire à pharmacie

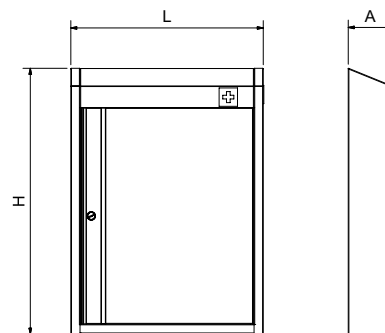

L	A	H	Kg	Barcode	€
523	120	723	9,00	080830	<b>360,00</b>

**Indicador de suelo mojado**  
Display wet floor  
Affiche sol humide

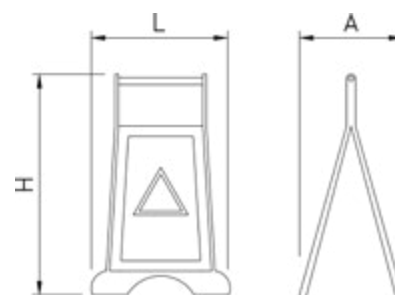

L	A	H	Gr	Barcode	€
420	300	620	400	465622	<b>15,00</b>

**Cinta antideslizante adhesiva amarillo/negro**  
Yellow/black adhesive non-slip tape  
Ruban adhésif antidérapant jaune/noir



L	A	Gr	Barcode	€
18000	50	670	465624	<b>40,00</b>

**Carro de limpieza**  
Cleaning cart  
Panier à nettoyage

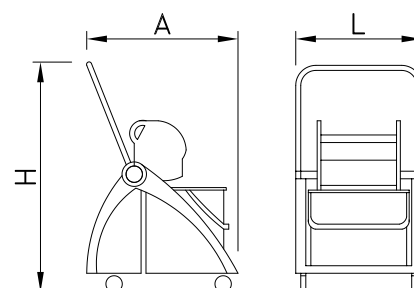

L	A	H	Kg	Barcode	€
440	850	700	9,70	465620	<b>145,00</b>

### Carro de limpieza multifunción con bolsa, plataforma y 3 bandejas

Multifunction cleaning trolley with bag, platform and 3 shelves

Chariot de nettoyage multifonction avec sac, plate-forme et 3 plateaux

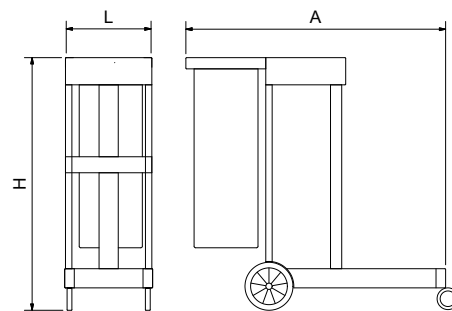

L	A	H	Kg	Barcode	€
510	980	1135	14,10	465618	190,00

### Espátula plástica, metal detectable

Plastic spatula, metal detectable

Spatule plastique, métal détectable, rouge

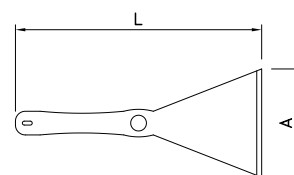

L	A	Gr	Barcode	€
250	110	110	482024	17,00

### Escoba haragán para empujar agua, con mango ergonómico

Floor squeegee to remove water, with ergonomic handle

Balai pour pousser l'eau, avec manche ergonomique

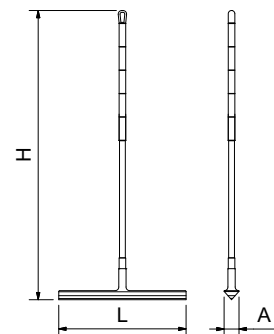

L	A	H	Kg	Barcode	€
700	45	1.590	1,03	482002	40,00

### Cepillo + palo polipropileno alimentario

Broom and stick in polypropylene for food use

Balai et manche en polypropylène pour usage alimentaire

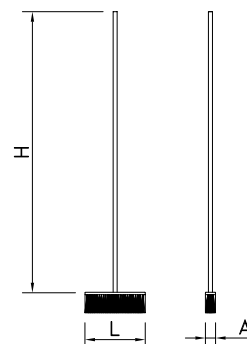

L	A	H	Gr	Barcode	€
300	50	1.500	250	482020	40,00

### Cepillo de mano multiusos metal detectable

Multipurpose handheld brush, metal detectable  
Brosse à main multi usage métal détectable

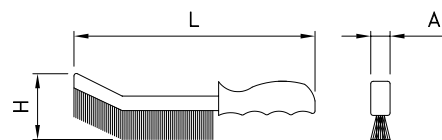

L	A	H	Gr	Barcode	€
410	55	60	270	482022	46,00

### Juego de 4 esponjas de colores

4 piece sponge set - different colors  
Set de 4 éponges de couleurs

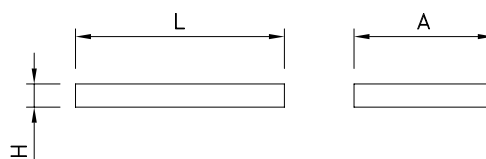

L	A	H	Gr	Barcode	€
135	90	15	48	482026	6,00

### Recogedor de mano inox

Long handle stainless dustpan  
Peel inoxydable avec manche

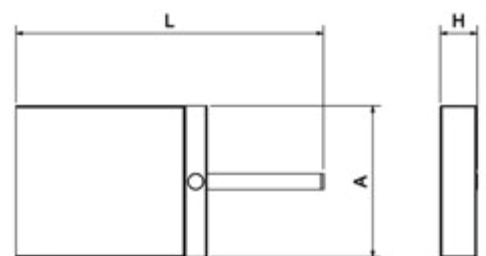

L	A	H	Gr	Barcode	€
390	192	47	600	084404	36,00

### Recogedor inox

Stainless steel dustpan  
Peel inoxydable

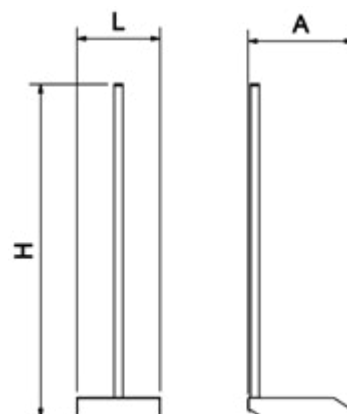

L	A	H	Kg	Barcode	€
244	192	770	1,0	084402	42,00



### Recogedor con palo metálico

Dustpan with metal handle  
Pelle avec manche métallique

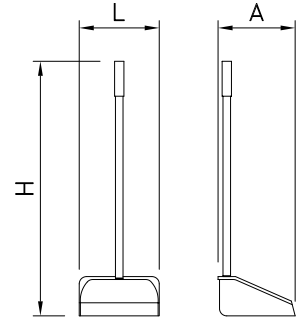

L	A	H	Gr	Barcode	€
275	265	875	250	482006	<b>4,00</b>

### Fregona profesional con tiras de microfibra y casquillo Pro

Professional mop with microfiber strips and Pro cap  
Vadrouille professionnelle avec bandes en microfibre et capuchon Pro



D	H	Color	Gr	Barcode	€
320	110	Green	195	482038	<b>6,00</b>
		Red		482040	
		Purple		482042	
		Blue		482044	
		Yellow		482046	
		Orange		482048	

### Cubo plástico con asa metálica para fregar

Plastic cleaning bucket, metal handle  
Seau de ménage avec poignée métallique

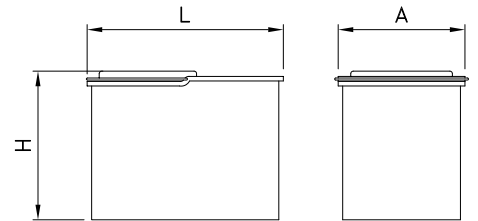

L	A	H	Gr	Barcode	€	
380	280	290	15	600	465626	<b>10,00</b>

### Cubo industrial asa de acero inoxidable

Industrial bucket in stainless steel  
Seau industriel en acier inoxydable



Características:  
Material: HDPE.

Characteristics:  
Material: HDPE.

Caractéristiques:  
Matériel: HDPE.

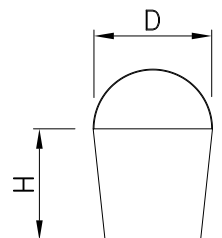

D	H	Gr	Barcode	€	
300	280	13	815	474462	<b>25,00</b>

**Cubo de acero inoxidable con tapa 15L serie GO**  
 GO series 15L stainless steel bucket with lid  
 Seau inox 15L série GO avec couvercle

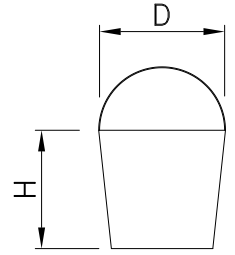

D	H	liters	Kg	Barcode	€
340	308	15	1,4	474488	<b>19,00</b>

**Cubos premium de acero inox**  
 Premium stainless steel bucket  
 Seaux premium en acier inoxydable

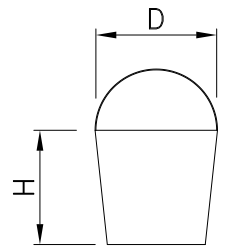

H	D	liters	Gr	Barcode	€
288	300	10 lts.	2.200	474492	<b>53,00</b>
370	325	15 lts.	3.000	474496	<b>63,00</b>
	295	10 lts.	500	474494	<b>18,00</b>
	320	15 lts.	650	474498	<b>21,00</b>

**Barreños**  
 Plastic basin for food use  
 Baquets ronds aliments

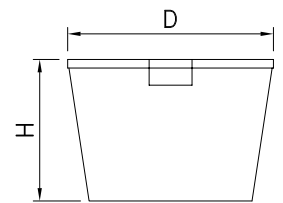

D	H	liters	Gr	Barcode	€
390	410	35	990	483050	<b>19,00</b>
460	470	50	1.500	483054	<b>25,00</b>

**Tapa para barreños**  
 Lid for plastic basin for food use  
 Couvercle pour bassine

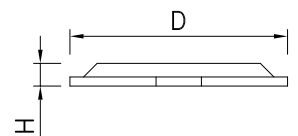

D	H	Gr	Barcode	€
390	50	560	483056	<b>8,00</b>
460	50	600	483058	<b>10,00</b>

**Urinaros inox**  
Inox urinals  
Urinoir inox



**Características:**

Urinaros individuales y colectivos, para fijación mural, en acero inoxidable.

Entrada de agua superior de 3/8" conectada a tubo con reparto de descarga por toda la superficie del urinario.

Cubeta con desagüe central, diámetro de salida 1 y 1/2".

Incluye kit de fijación y un filtro aromatizante, color azul.

**Characteristics:**

Single and collective urinals, for wall mounting, stainless steel.

Upper water inlet 3/8" connected with discharge distribution across the surface of the urinal. Tank fitted with central drain, outlet diameter 1 1/2"

Mounting kit and blue scented filter included.

**Caractéristiques:**

Urinoirs individuels et collectifs, pour montage mural, en acier inoxydable.

Entrée d'eau supérieure 3/8" relié au tube de distribution pour décharge en long de la surface de l'urinoir. Muni de drain, diamètre de sortie de 1 1/2"

Kit de montage et filtre bleu parfumée inclus.

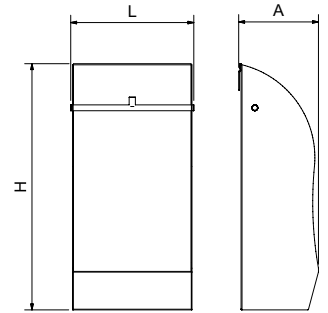

No incluye válvulas de agua.  
Water valves not included.  
Robineets d'eau non inclus.



Ver pág. 235.  
See p. 235.  
Voir p. 235.

L	A	H	Kg	Barcode	€
335	217	670	7,00	065002	<b>443,00</b>
1.575	217	670	22,00	065004	<b>661,00</b>



**WC inox**  
Inox WC pan  
Cuvette WC inox



456022 74,00

Tapa  
Toilet lids  
Toilette couvercle

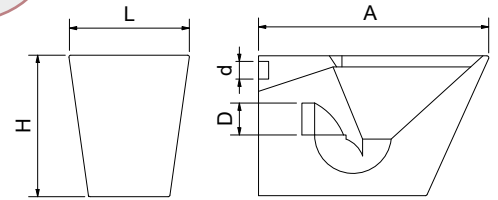
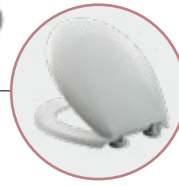

	L	A	H	D	d	Kg	Barcode	€
	355	640	390	100	60	7,89	456018	<b>1.049,00</b>
	370	800	460	100	60	6,90	456020	<b>1.049,00</b>

**Taza turca inox**  
Inox squat toilet  
Toilette turque inox

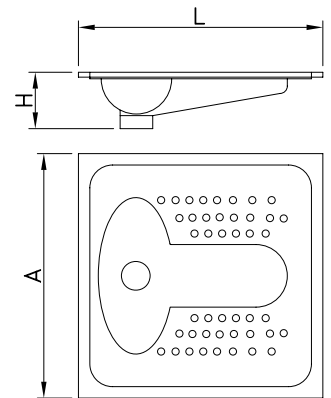

L	A	H	Kg	Barcode	€
750	750	133	6,27	456010	<b>276,00</b>

**Estación de higiene para wc con dispensador de papel y escobillero en acero inoxidable**  
Hygiene station for toilet, with roll holder and brush in stainless steel  
Station d'hygiène WC avec distributeur de papier et porte-brosse en acier inoxydable

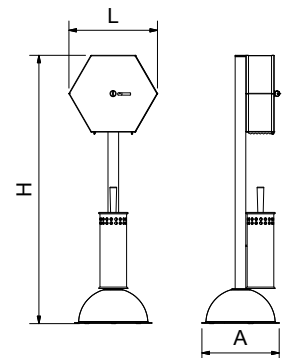

L	A	H	Kg	Barcode	€
332	290	1.005	10,00	062010	<b>207,00</b>

**Set de cepillo y soporte inoxidable para baño**  
 Brush and holder set for toilet  
 Brosse et support inoxydable pour bains



 Incluye fijación a pared.  
 Includes wall fixing.  
 Comprend fixation murale.

H	D	Gr	Barcode	€
370	85	565	460240	<b>13,00</b>

**Plato ducha inox**  
 Inox shower tray  
 Plateaux douche inox

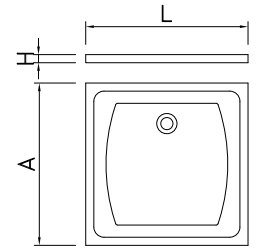

L	A	H	Kg	Barcode	€
750	750	40	5,50	456002	<b>294,50</b>
800	800	40	5,70	456004	<b>287,00</b>

**Jabonera**  
 Soap dish  
 Porte savon

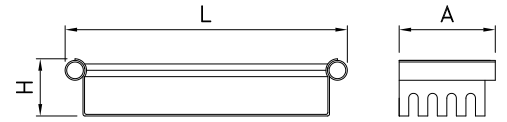

L	A	H	Gr	Barcode	€
350	121	70	170	460270	<b>39,00</b>

**Toallero**  
 Towel bar  
 Barre porte serviette

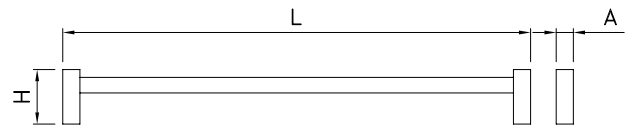

L	A	H	Gr	Barcode	€
600	55	50	200	460274	<b>27,00</b>

**Portarrollos papel higiénico**  
 Toilet paper roll dispenser  
 Distributeur papier hygiénique

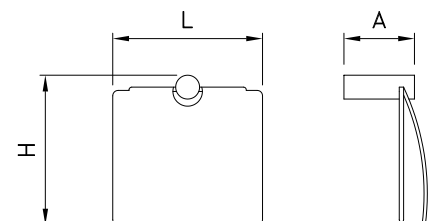

L	A	H	Gr	Barcode	€
102	55	115	160	460272	<b>20,00</b>



**Portarollos papel higiénico con repisa**  
Toilet roll holder with shelf  
Porte-rouleau de papier toilette avec étagère

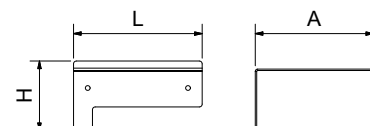

L	A	H	Gr	Barcode	€
136	125	74	330	062004	<b>11,00</b>

**Perchero individual**  
Individual hanger  
Patère individuel

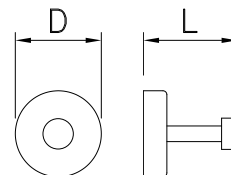

L	D	Gr	Barcode	€
55	50	70	460276	<b>14,00</b>

**Repisa**  
Towel shelf  
Tablette porte-serviettes

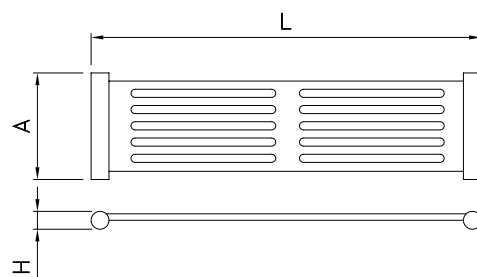
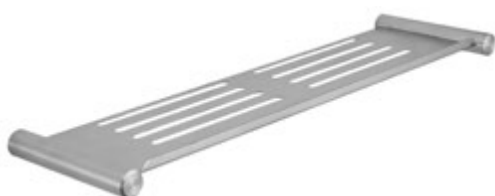

L	A	H	Gr	Barcode	€
480	131	22	210	460278	<b>46,00</b>

**Tendedero retráctil**  
Retractable hanger  
Fil à linge retractable

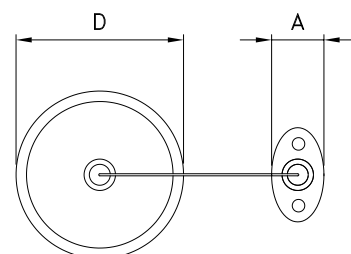

A	D	↔	Gr	Barcode	€
55	90	2,2 mts	140	481450	<b>18,00</b>

**Espejo antivandálico acero inoxidable**  
Tamper proof mirror in stainless steel  
Miroir en acier inoxydable anti-vandalisme

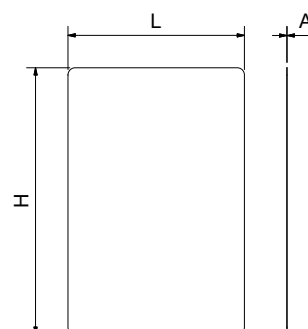

L	A	H	Kg	Barcode	€
490	1	740	2,90	062020	<b>55,00</b>

## Cambiador de pañales horizontal plegable

Fold-down baby changing unit  
Table pliante à langer horizontale



### Características:

Amplio cambiador de bebés plegable antibacteriano de fijación mural, ideal para instalar en aseos públicos, centros comerciales y grandes superficies, establecimientos sanitarios, restaurantes, etc. Incorpora un gancho para que los usuarios puedan colgar bolsas o cualquier elemento necesario, así como cinturón de seguridad ajustable para el bebé.

Su sistema hidráulico especial posibilita que la tapa permanezca cerrada para ahorrar espacio cuando no esté en uso.

### Characteristics:

Large fold-down antibacterial wall-mounted baby changing unit, ideal to be installed in public toilets, malls and department stores, health facilities, restaurants, etc.

It is fitted with a hook so that users can hang bags or any necessary item, as well as an adjustable safety belt for the baby.

Its special hydraulic system allows the lid to remain closed to save space when not in use.

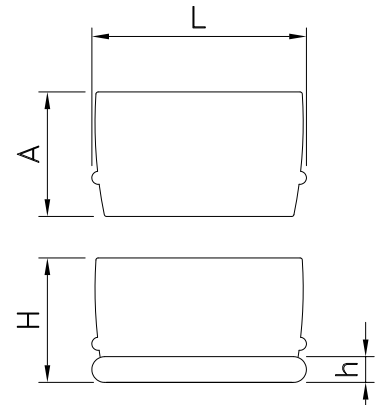

### Caractéristiques:

Grande table à langer murale pliante antibactérienne, idéale pour une installation dans les toilettes publiques, les centres commerciaux et les grandes surfaces, les établissements de santé, les restaurants, etc.

Il intègre un crochet pour que les utilisateurs puissent accrocher des sacs ou tout objet nécessaire, ainsi qu'une ceinture de sécurité réglable pour le bébé.

Son système hydraulique spécial permet au couvercle de rester fermé pour économiser de l'espace lorsqu'il n'est pas utilisé.

L	A	H	h	Kg	Barcode	€
860	500	590	80	9,80	460256	<b>270,00</b>

## Puesto de lavado y desinfección

Sanitising and disinfectant spray system  
Poste de lavage et de désinfection



### Características:

Soporte inox. para 1 garrafa de 5 litros.

### Characteristics:

Inox holder for 5 litres tank

### Caractéristiques:

Support inox pour réservoir de 5 litres

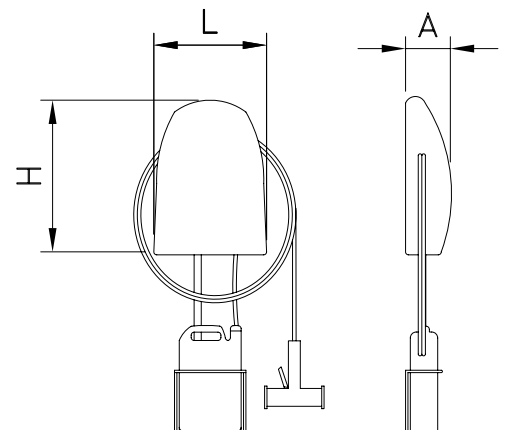

Longitud de manguera: 15 mts.  
Hose length: 15 mts.  
Longueur du tuyau: 15 mts.

L	A	H	Kg	Barcode	€
350	120	480	2,6	465602	<b>550,00</b>

### Columna inox de desinfección para gel hidroalcohólico

Stainless steel disinfection column for hydroalcoholic gel

Colonne de désinfection en acier inoxydable pour gel hydroalcoolique

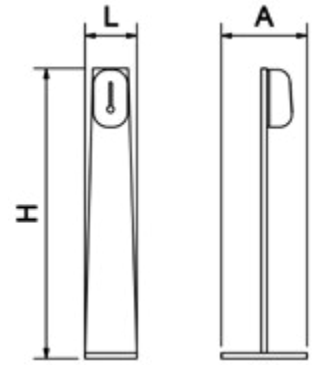

L	A	H	Kg	Barcode	€
212	350	1.190	3,5	064636	<b>90,00</b>

### Dispensador de gel hidroalcohólico automático de columna

Automatic hand sanitiser dispensing station

Distributeur automatique de gel hydroalcoolique sur colonne



Funcionamiento a pilas  
Batteries functioning  
Fonctionnement a piles

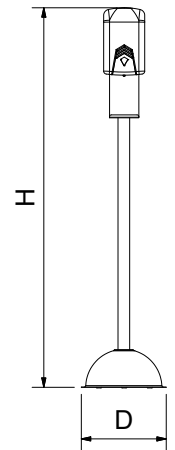

D	H	Kg	Barcode	€
290	1300	9,95	064604	<b>153,00</b>

### Columna mixta para guantes y dispensador electrónico de gel hidroalcohólico

Automatic hand sanitiser and gloves dispensing station

Colonne à gants mixtes et distributeur électronique de gel hydroalcoolique



Funcionamiento a pilas  
Batteries functioning  
Fonctionnement a piles

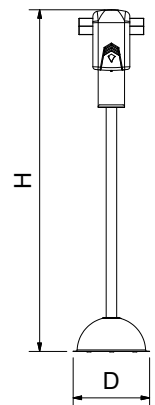

D	H	Kg	Barcode	€
290	1300	10,85	064605	<b>207,00</b>



**Columna para botella de gel hidroalcohólico**  
 Hand sanitiser holder dispensing station  
 Colonne pour bouteille de gel hydroalcoolique

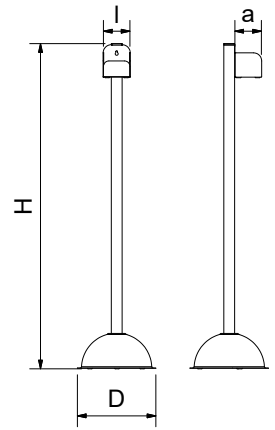

L	H	D	a	Kg	Barcode	€
98	1200	290	98	10,20	064606	<b>110,00</b>

**Columna mixta para guantes y botella de gel hidroalcohólico**  
 Hand sanitiser holder and gloves dispensing station  
 Colonne mixte gants mixtes et bouteille de gel hydroalcoolique

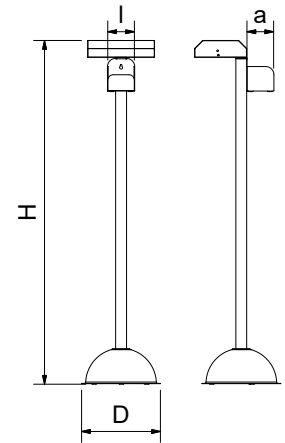

L	H	D	a	Kg	Barcode	€
98	1265	290	98	11,10	064608	<b>160,00</b>

**Soporte de sobremesa o mural para botella de gel hidroalcohólico**  
 Wall-mounted or tabletop hand sanitiser holder  
 Support de table ou mural pour bouteille de gel hydroalcoolique

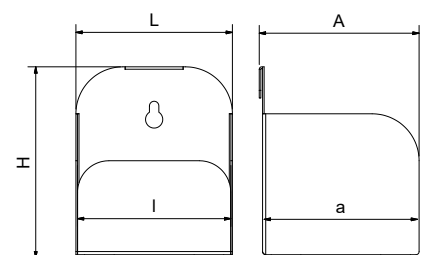

L	I	A	a	H	Kg	Barcode	€
100	98	102	98	122	0,36	264612	<b>16,00</b>



### Columna con dosificador de gel hidroalcohólico de funcionamiento a codo

Elbow operated hand sanitiser dispensing station

Colonne avec distributeur de gel hydroalcoolique à commande par coude

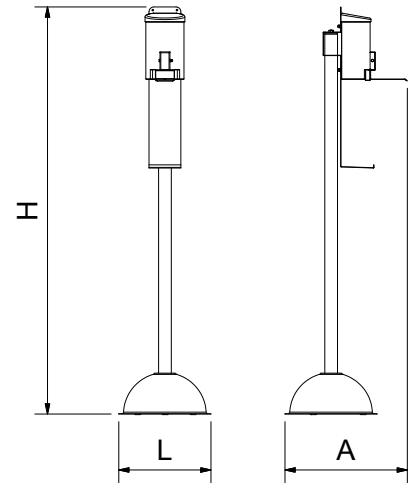

L	A	H		Kg		€
290	430	1.280	1 lts	10,00	064618	<b>155,00</b>

### Columna con dispensador de gel hidroalcohólico especial para niños

Automatic hand sanitiser dispensing station, especially for children

Colonne avec distributeur de gel hydroalcooliques pécial pour enfants



Funcionamiento a pilas  
Batteries functioning  
Fonctionnement a piles

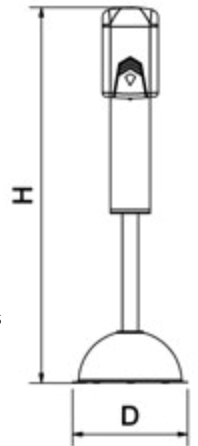

D	H		Kg		€
290	950	1 lt	7,00	064632	<b>188,00</b>

### Columna para botella de gel hidroalcohólico especial para niños

Hand sanitiser holder dispensing station, especially for children

Colonne avec distributeur de gel hydroalcooliques pécial pour enfants

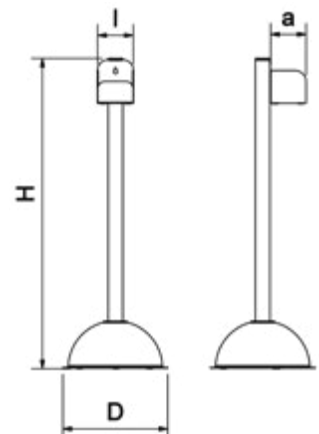

D	H	l	a	Kg		€
290	855	98	98	4,00	064634	<b>138,00</b>

## Accesorios para columnas de gel

Accessories for hand sanitiser dispensing stations  
Accessoires pour colonnes de gel



064628 100,00

**Termómetro infrarrojo con adaptador para columna**  
Infrared thermometer with column adaptor  
Thermomètre infrarouge avec adaptateur pour colonne



080610 81,00

**Papelera acoplada**  
Docked / fixed wastebasket  
Poubelle pour accoupler



064612 45,00

**Dispensador de papel mecha acoplado a columna**  
Wick paper dispenser attached to Centerfeed paper  
Distributeur de papier cheminé fixé à la colonne



064614 14,00

**Emplazamiento publicitario opcional para columna**  
Optional advertising spot  
Placement publicitaire en option pour la colonne

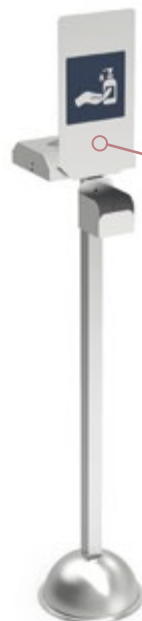

## Dispensador de gel hidroalcohólico de gran capacidad a pedal

Pedal operated large capacity hand sanitiser dispensing station  
Distributeur de gel hydroalcoolique haute capacité à pédale

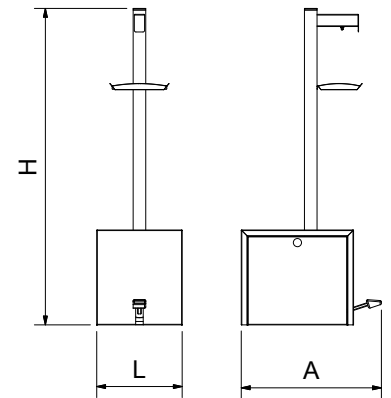

L	A	H				€
272	445	1006	5 lts	9,00	064622	<b>374,00</b>

## Dispensador de gel hidroalcohólico automático en acero inox

Automatic hand sanitiser dispenser  
Distributeur automatique de gel hydroalcoolique en acier inox



### Características:

Construcción en acero inoxidable.  
Sensor infrarrojo de aplicación.  
Fácil instalación.  
Limpio, robusto y duradero.

La operación se realiza sin contacto evitando la contaminación cruzada de patógenos. Al colocar las manos debajo, expulsa una dosis de solución alcohólica evaporable.

Lugares de instalación: hospitales, clínicas, fábricas de productos alimenticios, comedores colectivos, aeropuertos, restaurantes, etc...

4 baterías AA de 1,5 V.  
Capacidad 1 litro.  
500 pulverizaciones.  
Instalación mural.

### Characteristics:

Wholly made of stainless steel.  
Infrared sensor controlled.  
Easy installation and maintenance.  
Robust and lasting.

Touch-free operation to avoid pathogen cross-contamination: when placing your hands underneath, it ejects a dose of evaporable alcoholic solution.

Suitable for hospitals, food manufacturing plants, collective dining, airports, restaurants, etc...

4 batteries AA - 1,5 V.  
Capacity of liquid container: 1.000 ml.  
500 doses.  
Wall-mounted.

### Caractéristiques:

Entièrement en acier inoxydable.  
Fonctionnement par senseur infrarouge.  
Facilité d'installation et d'entretien.  
Robuste et durable.

Désinfectez vos mains sans contact pour éviter la contamination croisée des agents pathogènes. Lorsque vous placez vos mains en dessous, il est éjecté une dose de solution évaporable alcoolique.

Convient pour les hôpitaux, les usines alimentaires, restauration collective, les aéroports, restaurants, etc...

4 piles AA - 1,5 V.  
Capacité du réservoir de liquide: 1.000 ml.  
500 doses.  
Fixation murale.

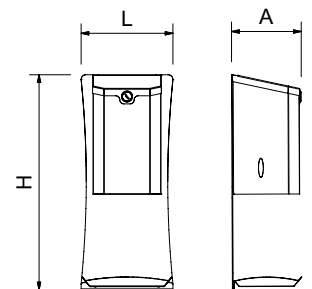

L	A	H			€
192	145	450	2,6	064602	<b>98,00</b>

### Dosificador de jabón

Soap dispenser  
Doseur de savon

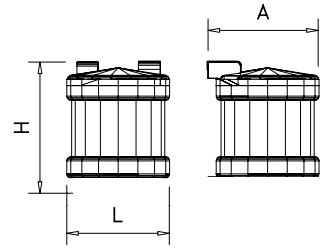

L	A	H		Gr		€
120	120	170	1 lts	270	460202	10,00

### Dosificador de jabón

Soap dispenser  
Doseur de savon



#### Características:

La tapa y el pulsador, por su diseño, no permite el apoyo de cigarrillos manteniendo un aspecto inmejorable. La estructura del vaso no permite que penetren impurezas en el conjunto pulsador, prolongando la vida del dispensador.

#### Characteristics:

The cover and the push-button, for their design, do not allow the support of cigarettes, maintaining an excellent aspect. The structure of the vase does not allow the penetration of impurities, prolonging the length of the dispenser.

#### Caractéristiques:

La couverture et le bouton-poussoir, par son desine, ne permettent pas l'appui des cigarettes et maintiennent un aspect excellent. La structure du vase ne permette pas que pénètrent impuretés dans le conjoint poussoir, prolongant ainsi la durée du dispensateur.

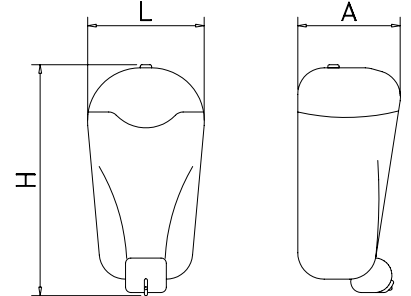

L	A	H		Gr		€
112	105	210	1 lts	356	460204	19,00

### Dosificador de jabón modelo Nube

Soap dispenser, Cloud model  
Distributeur de savon modèle Nuage

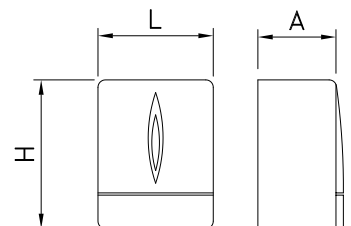

L	A	H		Gr		€
155	115	201	544	460282	22,00	

### Dosificador de gel-espuma

Foam gel dispenser  
Doseur pour gel à mousse

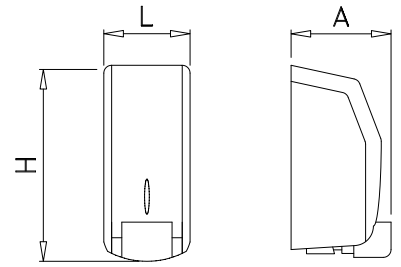

L	A	H				€
110	105	205	0,7 lts	500	460222	19,00

### Jabonera electrónica (funcionamiento a pilas)

Hands-free soap dispenser (battery working)  
Doseur de savon automatique (à piles)



4 baterías AA de 1,5 V.  
4 batteries AA - 1,5 V.  
4 piles AA - 1,5 V.

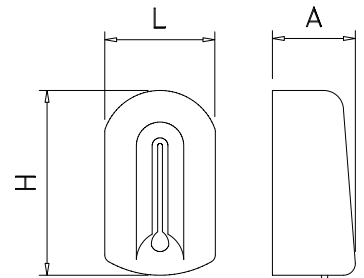

L	A	H				€
140	105	235	1 lts	525	460236	39,00

### Dosificador automático de gel hidroalcohólico con soporte de sobremesa

Hands-free dispenser of hydroalcoholic gel worktop support  
Distributeur automatique de gel hydroalcoolique avec support sur table



4 pilas tipo C  
4 Type C batteries  
4 piles type C

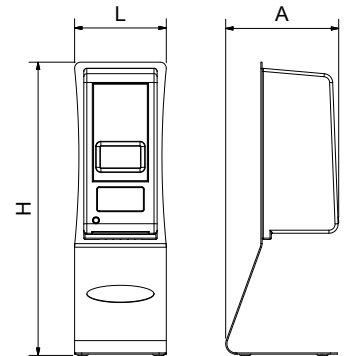

L	A	H				€
150	185	480	1 lts	2,00	064626	112,00

### Dosificador de jabón inox

Stainless steel soap dispenser  
Doseur de savon en acier inoxydable

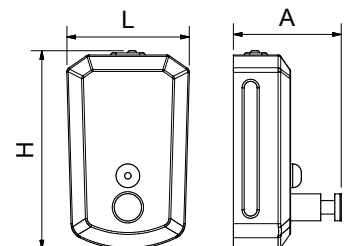

L	A	H				€
122	66	202	1,2 lts	900	460220	29,00

### Dosificador de jabón inox encastrable

Stainless steel soap dispenser to be embedded  
Doseur de savon en acier inoxydable pour adosser

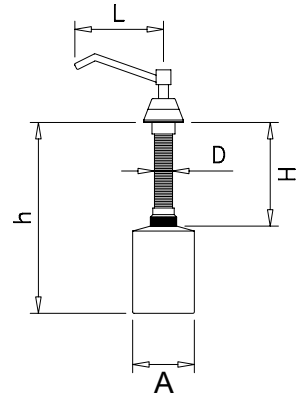

L	A	H	h	D				€
105	75	132	240	22	500 ml	580	460218	<b>45,00</b>

### Secamanos inox con pulsador y tobera

Stainless push-button operated hand dryer with nozzle  
Sèche-mains inox avec poussoir et tuyère

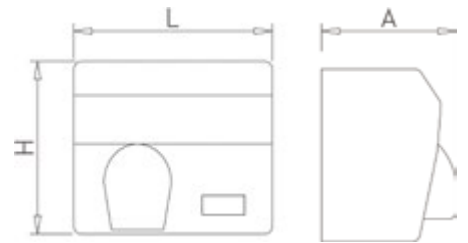

L	A	H		Tensión Voltage Tension	Frecuencia Frequency Frequence	Potencia Power Puissance			€
260	207	235	30	220-240 V	50/60 Hz	2300 W	6,30	460290	<b>175,00</b>

### Secamanos óptico inox satinado con tobera

Stainless satiny optic hand dryer with nozzle  
Sèche-mains optique inoxydable satiné avec tuyère

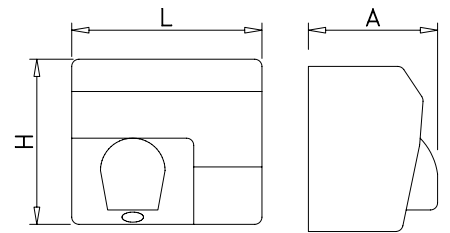

L	A	H		Tensión Voltage Tension	Frecuencia Frequency Frequence	Potencia Power Puissance			€
275	200	230	30	220 V	50Hz	2300 W	4,60	460228	<b>185,00</b>

### Secamanos óptico inox satinado sin tobera

Stainless satiny optic hand dryer without nozzle  
Sèche-mains optique inoxydable satiné sans tuyère

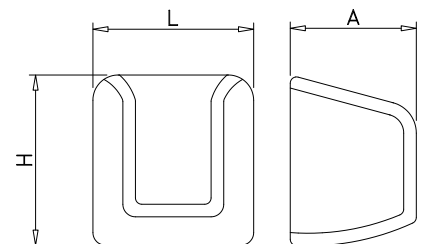





L	A	H		Tensión Voltage Tension	Frecuencia Frequency Frequence	Potencia Power Puissance			€
290	175	323	100	220 V	50 Hz	1.200 W	3,16	460226	<b>178,00</b>

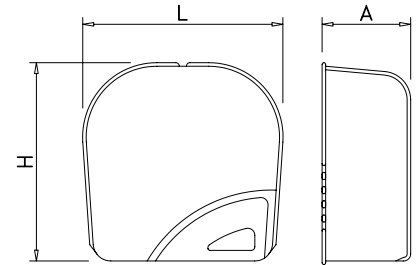

## Secamanos óptico en ABS

ABS optic hand dryer  
Sèche mains optique ABS





L	A	H		Tensión Voltage Tension	Frecuencia Frequency Frequence	Potencia Power Puissance			€
275	127	250	10	230 V	50 Hz	1.750 W	2,7	460206	<b>120,00</b>

## Secamanos óptico en ABS sin tobera modelo Nube

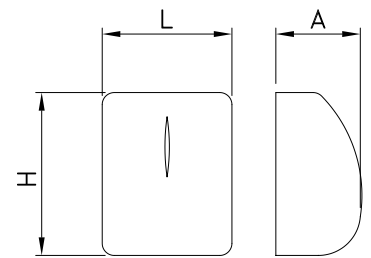
ABS automatic hand dryer without nozzle, Cloud model  
Sèche-mains optique ABS sans tuyère modèle Nuage



L	A	H		Tensión Voltage Tension	Frecuencia Frequency Frequence	Potencia Power Puissance			€
215	140	270	25	230 V	50 Hz	1.800 W	1,3	460286	<b>163,00</b>

## Secamanos inox de bajo consumo

Stainless steel low consumption hand dryer  
Sèche mains inox consommation bas



### Características:

Seca las manos mediante aire comprimido a alta velocidad.

Sin resistencia eléctrica, consigue calentar el aire mediante el aprovechamiento de la potencia del motor, reduciendo al máximo el consumo eléctrico.

### Characteristics:

Dries hands with a high flow of compressed air.



Without electrical resistance, the air gets heated by using the power of the engine, minimizing the electricity consumption.

### Caractéristiques:

Séchage de mains avec air comprimé à fort débit.

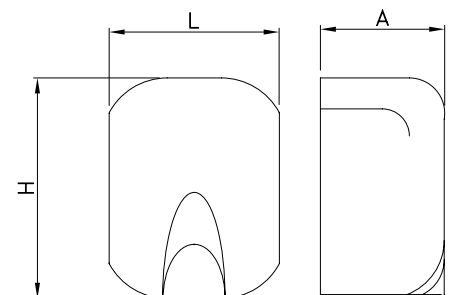
Sans résistance électrique, l'air est chauffé à l'aide de la puissance du moteur, réduisant la consommation d'électricité.



L	A	H		Tensión Voltage Tension	Frecuencia Frequency Frequence	Potencia Power Puissance			€
221	157	285	76	220/240 V	50/60 Hz	550 W	3,0	460250	<b>390,00</b>



## Secamanos ultrarápido

Ultra-fast hand dryer  
Sèche-main ultra-rapide



**Caractéristiques:**  
Nouvelle conception ergonomique pour sèche à mains. Il n'a pas besoin d'une résistance pour chauffer l'air, ce pour cela qu'il économise un 80% la consommation de séchage par rapport aux systèmes papier ou de coton. Séchage complet ultra-rapide grâce à son double flux d'air comprimé. Fabriqué en ABS.

### Características:

Nuevo concepto de diseño ergonómico para el secado de manos.

Menor consumo energético al no lleva resistencia para calentar el aire, ahorra hasta un 80 % los costes de secado frente a sistemas de papel especial o algodón.

Secado perfecto ultrarrápido gracias a su doble flujo de aire comprimido. Construido en ABS.

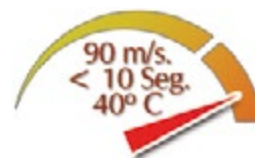





### Characteristics:

New conception of ergonomic design for hand dryers.

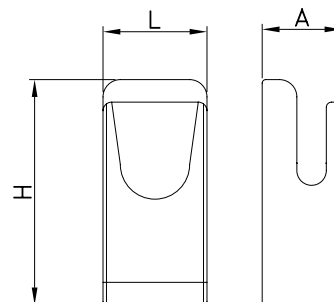
It does not need a resistance for heating air, which means an 80% of drying consumption reduction in comparison with paper or cotton systems.

Ultra-fast and thorough drying, thanks to its double flow of compressed air. Made of ABS.



L	A	H	 m/s	Tensión Voltage Tension	Frecuencia Frequency Frecuency	Potencia Power Puissance	 Kg		€
300	220	687	95	220 V	50 Hz	1.650 W	11,60	460238	<b>700,00</b>

## Dispensador de rollos de papel higiénico

Dispenser for rolls of toilet paper  
Dévidoirs de rouleaux de papier hygiénique



Tipo de rollo: Bobina de Ø 250 mm. / 300 m.  
Ejes: Ø de 25, 45 y 60 mm

Type of roll: Ø 250 mm. / 300 m.  
Axes: Ø 25, 45 y 60 mm

Type de rouleau: Ø 250 mm. / 300 m.  
Axes: Ø 25, 45 y 60 mm

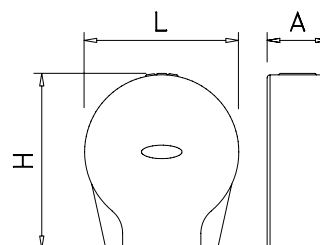

L	A	H	 Gr		€
275	120	275	500	460210	<b>17,00</b>

## Dispensador de rollos de papel higiénico inoxidable

Stainless steel dispenser for rolls of toilet paper  
Dévidoirs de rouleaux de papier hygiénique en acier inoxydable





Tipo de rollo: Bobina de Ø 250 mm. / 300 m.  
Ejes: Ø de 38 mm

Type of roll: Ø 250 mm. / 300 m.  
Axes: Ø 38 mm.

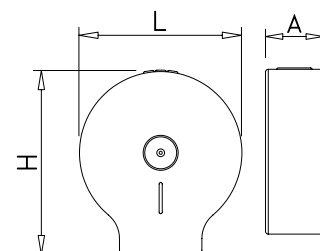
Type de rouleau: Ø 250 mm. / 300 m.  
Axes: Ø 38 mm.



L	A	H	 Kg		€
250	112	260	1,6	460212	<b>25,00</b>

## Dispensador de papel higiénico tripe en acero inoxidable

Triple toilet roll holder in stainless steel  
Triple distributeur de papier toilette en acier inoxydable

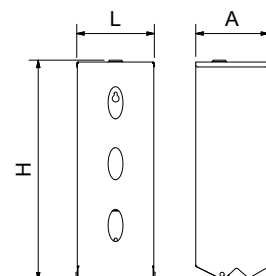

L	A	H	 Kg		€
126	118	356	1,28	062006	<b>69,00</b>

## Dispensador inox hexagonal de papel higiénico 400 m

Hexagonal stainless steel toilet roll holder 400 m

Distributeur de papier hygiénique hexagonal en acier inoxydable 400 m



Tipo de rollo: Bobina de Ø 275 mm. / 400 m.

Type of roll: Ø 275 mm. / 400 m.

Type de rouleau: Ø 275 mm. / 400 m.

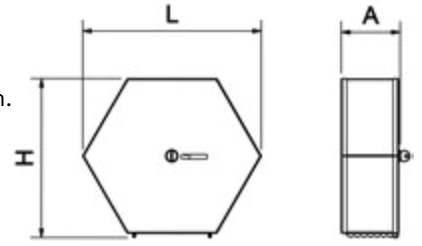

L	A	H	Kg	Barcode	€
335	110	300	1,7	062002	<b>40,00</b>

## Dispensador de toallas

Towels dispenser

Dispensateur d'essuie-mains



### Características:

El innovador diseño del conjunto llave-cerradura ofrece seguridad al producto, evitando un mal uso del papel. Sus formas redondeadas de mayor resistencia al impacto permiten ofrecer un producto robusto y capaz de adaptarse a cualquier entorno.

### Characteristics:

The innovating design of the set key-lock offers security to this product and avoids a wrong usage of the paper. Its rounded shapes of a higher impact resistance let offer a strong product capable to be adapted at any place.

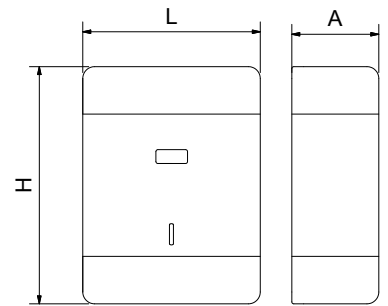

### Caractéristiques:

L'innovateur dessin du conjoint clé-fermeture, offre sécurité au produit, en évitant le mal usage du papier. Ses formes arrondies d'une plus grande résistance au impacte permettent offrir un produit robuste et capable pour s'adapter a quelque endroit.

L	A	H	Shield	Kg	Barcode	€
275	130	360		1,1	460214	<b>21,00</b>
600 servicios Use for 600 applications 600 applications d'usage						

## Dispensador en acero inoxidable de toallas de papel

Stainless steel towel dispenser

Dispensateur en acier inoxydable d'essuie-mains

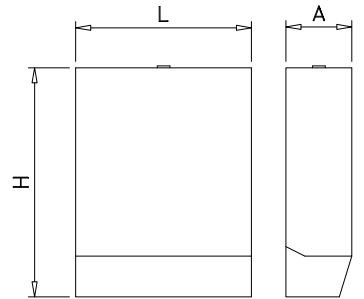

L	A	H	Shield	Kg	Barcode	€
238	115	304		1,65	062030	<b>37,00</b>
400/600 servicios Use for 400/600 applications 400/600 applications d'usage						

## Dispensador de toallas de papel con autocorte

Paper towel dispenser with auto cutter

Distributeur de serviettes en papier avec coupe automatique

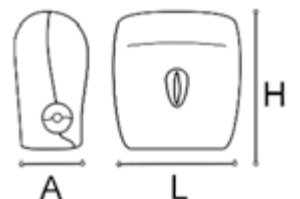

L	A	H	Kg	Barcode	€
280	233	382	2,30	460224	<b>75,00</b>

### Dispensador de bolsitas higiénicas

Higienic bags dispenser  
Distributeur de sacs hygiéniques

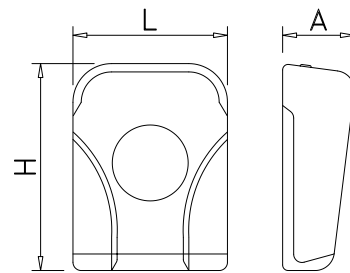

L	A	H	Gr	Barcode	€
120	40	155	130	460258	13,00

### Dispensador de papel mini-mecha modelo Nube

Centre feed mini towel dispenser, Cloud model  
Distributeur de papier cheminé modèle Nuage

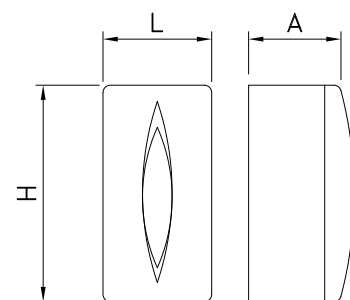

L	A	H	Gr	Barcode	€
147	143	293	170	460280	21,00

### Dispensador de papel higiénico modelo Nube

Toilet paper dispenser, Cloud model  
Distributeur de papier toilette modèle Nuage

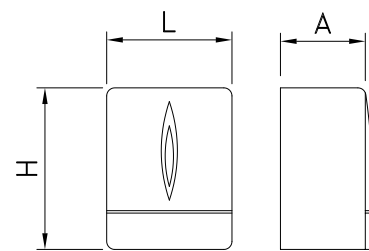

L	A	H	Gr	Barcode	€
276	143	275	765	460284	24,00

### Dispensador de toallas modelo Nube

Towel dispenser, Cloud model  
Distributeur de papier essuie-mains modèle Nuage

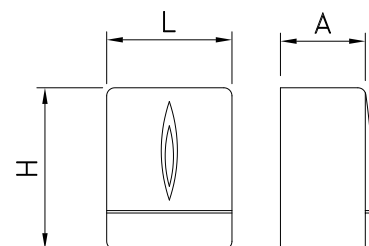

L	A	H	Gr	Barcode	€
308	149	331	1.057	460288	25,00



### Dispensador de papel mecha

Centerfeed wick-paper dispenser  
Dispensateur de papier-mèche



#### Características:

Dispensador de papel mecha muy funcional por su tamaño y sencillez. Para todo tipo de papel mecha con o sin precorte.

#### Characteristics:

Very useful wick-paper dispenser because of its size and simplicity. For all kinds of wick-paper, with or without cut.

#### Caractéristiques:

Dispensateur de papier-mèche très fonctionnel par ses dimensions et simplicité. Pour tous les types de papier-mèche, sans et avec coupure.

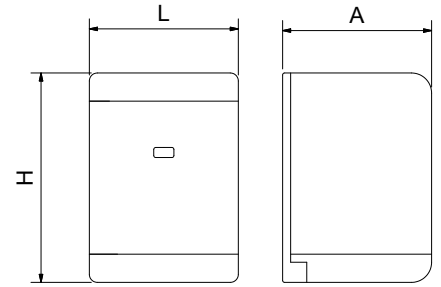

L	A	H	Gr	Barcode	€
220	220	310	730	460216	25,00

### Dispensador de papel mecha en acero inox

Stainless steel centerfeed wick-paper dispenser  
Dispensateur de papier-mèche en acier inoxydable

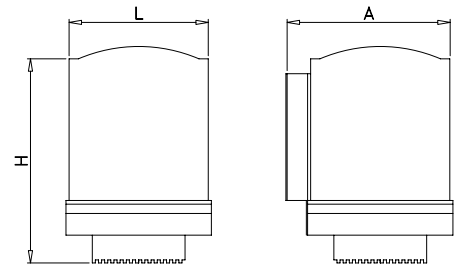

L	A	H	Kg	Barcode	€
250	270	320	3,3	460208	157,00

### Dispensador de bobina industrial

Industrial roll dispenser  
Distributeur de bobine industrielle

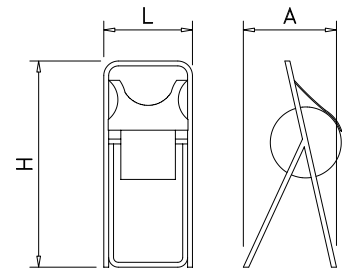

L	A	H	Gr	Barcode	€
400	360	930	225	460262	35,00

### Dispensador mural de bobina industrial

Industrial roll wall-dispenser  
Distributeur mural de bobine industrielle

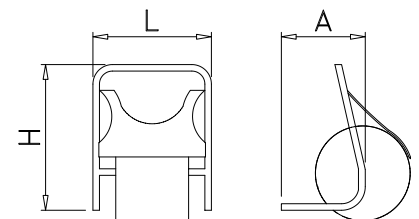

L	A	H	Gr	Barcode	€
390	240	460	100	460264	27,00

## Cepillos para limpieza de manos y uñas

Brushes for hands and nails washing  
Brosse pour le lavage des mains et ongles



### Características:

Los cepillos son desechables y ayudan a prevenir contagios en el lavamanos. El diseño único del cepillo elimina la suciedad y las bacterias de poros, arrugas, uñas y cutículas. Tan sólo utilícelo un día y deséchelo.

Color azul para fácil identificación y seguridad alimentaria.  
Canal central para limpieza bajo las uñas.

### Characteristics:

The brushes are disposable and help prevent cross-contamination at the hand washing sink. The unique design of the brush effectively removes soil and bacteria from pores, wrinkles, nails and cuticles. Simply use for a day and then throw it away.

Food safe blue colour for easy identification.  
Centre channel for cleaning under nails.

### Caractéristiques:

Les brosses sont jetables et aident à prévenir des contagés dans le lave-main. Le dessin unique du brosse élimine la saleté et les bactéries des pores, rides, ongles et cuticules. Uniquement utilisez-le un jour et jetez-le.

Couleur bleu pour son facile identification et sécurité alimentaire.  
Channel central pour nettoyer dessus les ongles.



## Dispensador inox para cepillos de limpieza de manos y uñas

Stainless steel dispenser for hands and nails washing-brusher  
Dispensateur inoxydable de brosses à mains et ongles

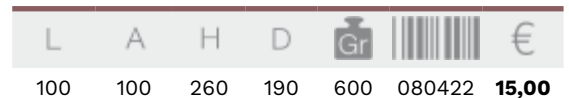
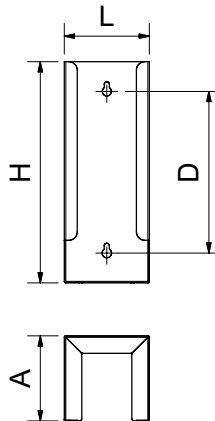

## Cepillo limpiauñas de uso personal

Nail brush for personal use  
Brosse à ongles pour usage personnel



### Características:

Elimina la suciedad y las bacterias de poros, arrugas, uñas y cutículas.

### Characteristics:

Remove dirtiness and bacteria from pores, wrinkles, nails and cuticles.

### Caractéristiques:

Éliminer saleté et bactéries des pores, rides, ongles et cuticules.

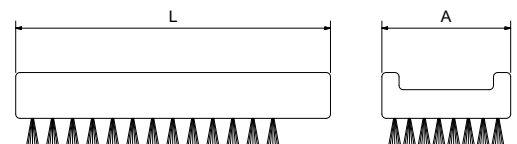

**Mampara de protección para colgar**  
 Hanging protection screen  
 Écran de protection pour suspendre

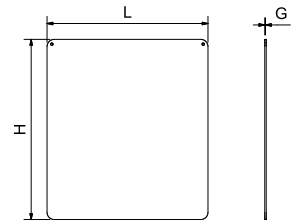

L	G	H	Kg	Barcode	€
670	6	750	4,64	480102	<b>53,00</b>

**Mampara de protección de sobremesa**  
 Desktop protection screen  
 Écran de protection sur table

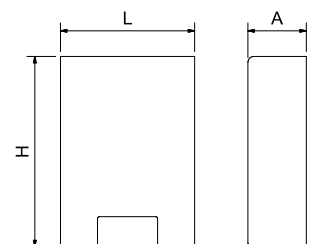
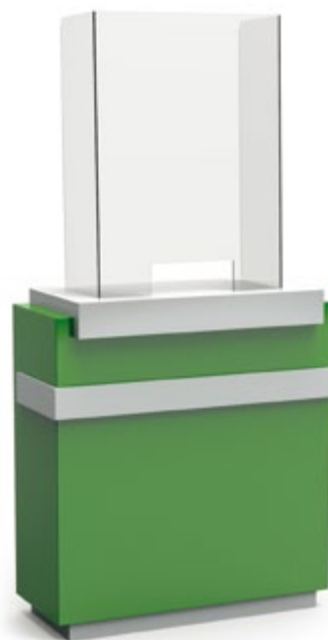

L	A	H	Kg	Barcode	€
670	292	950	10,44	480104	<b>65,00</b>

**Dispositivo para abrir puertas anti-contagio**  
 Anti-contagion opening door device  
 Dispositif pour ouvrir des portes anti-contagion

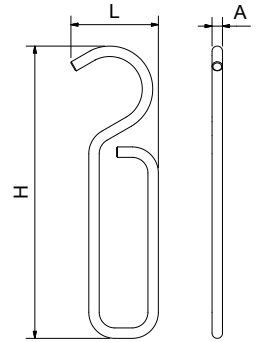

L	A	H	Gr	Barcode	€
50	7	165	80,00	023710	<b>1,00</b>

**Felpudo higiénico de caucho**  
 Rubber sanitary mat  
 Tapis hygiénique en caoutchouc

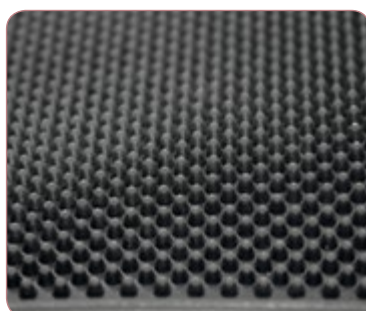

L	A	H	Kg	Barcode	€
530	370	17	2,90	481460	<b>15,00</b>
700	500	17	3,75	481462	<b>25,00</b>
800	600	17	3,55	481464	<b>37,00</b>
1200	800	17	3,55	481466	<b>125,00</b>



# Hachas

Axes  
Haches

## Hacha de cámara con mango de fibra

Chamber axe with polyethylene fibre handle  
Hache de chambre avec manche en fibre



### Applications:

Spéciale pour l'accomplissement de le règlement du UE pour chambres frigorifiques à grande superficie dont température de fonctionnement soit au-dessous de zéro.

On recommande son installation comme bonne coutume dans autres cases (restaurants, boucheries, poissonneries, etc.) ou on peut trouver chambres qui ne sont pas touchées par ce règlement, mais qui sont aussi à congélation et les travailleurs peuvent travailler dans s'intérieur avec la porte fermée.

### Aplicación:

Especial para el cumplimiento del reglamento de Industria ("Reglamento de Seguridad para Plantas e Instalaciones Frigoríficas", RD 3099/77) para cámaras frigoríficas de gran superficie cuya temperatura de trabajo sea inferior a 0 grados.

Se recomienda su instalación, como buena práctica, en otros casos (restaurantes, comercios, etc.) donde se pueden encontrar cámaras no afectadas por el reglamento de Industria, pero que son de congelación y en las que los trabajadores puedan trabajar en el interior de las mismas con la puerta cerrada.

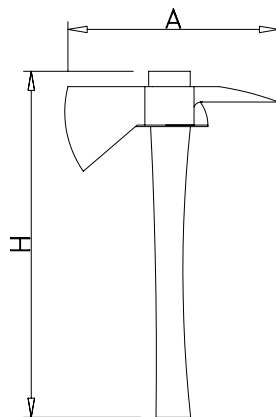

### Use:

Special for the compliance of the EU regulations on cold rooms of wide area which can work with temperatures below zero.

It is recommended to install it as a good use in other cases (restaurants, butcher shops, fish shops, etc.) where you can find cold rooms not affected by with this regulation, but that are also cold rooms where workers can work inside them with the door closed.

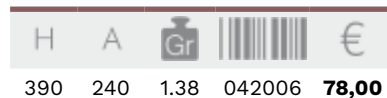

## Hacha de bombero con mango de fibra

Firefighter axe with polyethylene fibre handle  
Hache de pompier avec manche en fibre



### Applications:

Spéciale pour l'accomplissement de le règlement du UE pour chambres frigorifiques à grande superficie dont température de fonctionnement soit au-dessous de zéro.

On recommande son installation comme bonne coutume dans autres cases (restaurants, boucheries, poissonneries, etc.) ou on peut trouver chambres qui ne sont pas touchées par ce règlement, mais qui sont aussi à congélation et les travailleurs peuvent travailler dans s'intérieur avec la porte fermée.

### Aplicación:

Especial para el cumplimiento del reglamento de Industria ("Reglamento de Seguridad para Plantas e Instalaciones Frigoríficas", RD 3099/77) para cámaras frigoríficas de gran superficie cuya temperatura de trabajo sea inferior a 0 grados.

Se recomienda su instalación, como buena práctica, en otros casos (restaurantes, comercios, etc.) donde se pueden encontrar cámaras no afectadas por el reglamento de Industria, pero que son de congelación y en las que los trabajadores puedan trabajar en el interior de las mismas con la puerta cerrada.

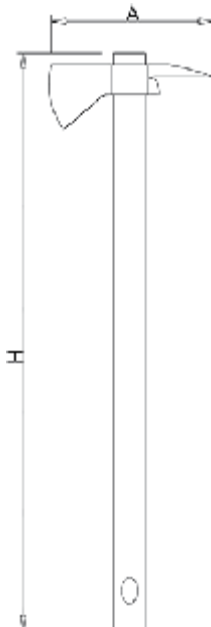

### Use:

Special for the compliance of the EU regulations on cold rooms of wide area which can work with temperatures below zero.

It is recommended to install it as a good use in other cases (restaurants, butcher shops, fish shops, etc.) where you can find cold rooms not affected by with this regulation, but that are also cold rooms where workers can work inside them with the door closed.

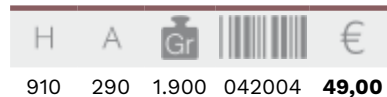





# COMPLEMENTOS

COMPLEMENTS  
COMPLEMENTS

## NOVEDADES

NEWS  
NOUVEAUTÉS



437



445

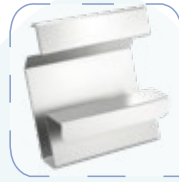

445



446

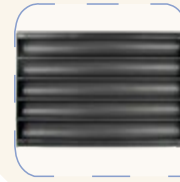

451



453



453



454



454

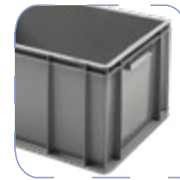

455



455



455



455



457



469



469



472



477

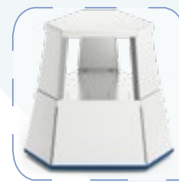

479



480

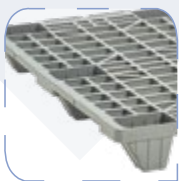

481



484



485



496



496





## Cubetas para helado

Ice cream container  
Bac à crème glacée



L	A	H	lit	Gr	Barcode	€
180	165	120	2,50	325	487400	<b>34,50</b>
330	165	120	5,00	610	487402	<b>24,00</b>
360	165	120	5,00	635	487404	<b>19,00</b>
330	250	80	5,50	600	487405	<b>34,50</b>
360	250	80	5,97	745	487406	<b>18,00</b>
265	160	80	3,00	310	487410	<b>18,00</b>
330	165	80	3,10	400	487412	<b>21,00</b>
360	165	80	3,30	430	487414	<b>19,00</b>
265	160	120	3,60	450	487416	<b>18,00</b>
330	250	120	7,00	890	487418	<b>56,00</b>
360	250	120	8,00	865	487419	<b>27,00</b>
265	160	150	4,00	590	487420	<b>23,00</b>
330	165	150	6,5	750	487422	<b>28,00</b>
360	165	150	6,5	590	487424	<b>27,00</b>
330	250	150	7,5	1.000	487426	<b>61,00</b>
360	250	150	10,8	985	487428	<b>35,00</b>

### Características:

Cubetas de acero inoxidable conforme a la norma EN 631, utilizadas para el sector del helado.

### Characteristics:

Set of stainless steel containers normalized according to the norm EN 631, used for ice cream.

### Caractéristiques:

Série de bacs en acier inoxydable normalisés selon la norme EN 631, utilisées pour glacée.



∅200 250 7,85 520 487408 **62,00**



265 160 20 100 487448 **7,50**



330 165 20 120 487450 **7,50**

360 165 20 135 487452 **5,80**



360 250 80 180 487454 **8,00**



260 ∅ 50 mm. 487480 **5,50**

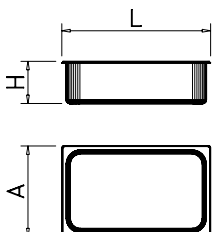

## Lavaporcionador de helados para encastrar

Built-in ice-cream scoop washer  
Rince bouliers à glace pour encastrar



**Características:**  
Entrada de agua con válvula de 3/8"  
Desagüe con válvula de 1/2"

**Characteristics:**  
Inlet valve 3/8"  
Outlet valve 1/2"

**Caractéristiques:**  
Entrée d'eau avec bonde de 3/8"  
Bonde d'évacuation de 1/2"

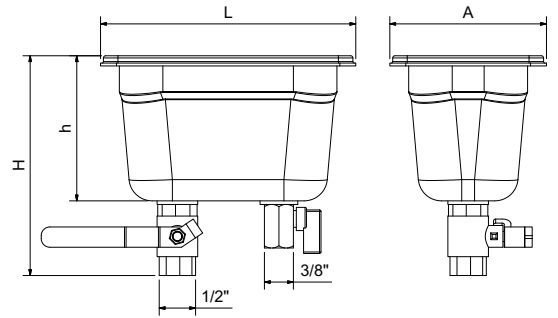

L	A	H	h	Gr	Barcode	€
176	108	151	100	500	082830	<b>76,00</b>

## Lavaporcionador de helados mural

Wall-mounted ice-cream scoop washer  
Rince bouliers à glace mural



**Características:**  
Entrada de agua con válvula de 3/8"  
Desagüe con válvula de 1/2"

**Characteristics:**  
Inlet valve 3/8"  
Outlet valve 1/2"

**Caractéristiques:**  
Entrée d'eau avec bonde de 3/8"  
Bonde d'évacuation de 1/2"

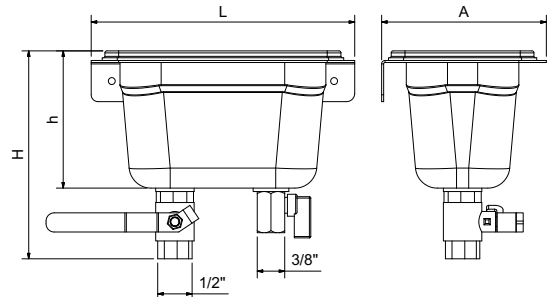

L	A	H	h	Gr	Barcode	€
192	120	151	100	700	082832	<b>97,00</b>

## Porcionadores de helado

Stainless steel and nylon ice cream scoop  
Boulier à glace



∅  
50  
mm.

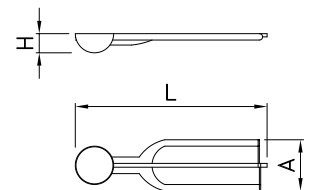

L	A	H	Color	Gr	Barcode	€
190	65	33	Red	200	Barcode	487470
			Blue			487472
			Orange			487474
			Green			487476
						<b>34,00</b>

## Porcionador automático de helado

Spring action ice-cream scoop

Cuillère à crème glacée avec lame intérieur



∅  
50  
mm.

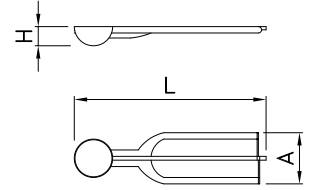

L	A	H	Gr	Barcode	€
220	65	50	220	440016	<b>6,00</b>

## Copa helado

Ice cream bowl

Bowl pour crème glacée

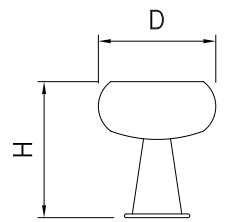

H	D	Gr	Barcode	€
110	85	150	487490	<b>23,00</b>
110	95	180	487492	<b>27,00</b>
110	105	200	487494	<b>29,00</b>

## Bandeja de exposición para helados en vaso

Display tray for ice cream glass

Plateau Présentoir pour glaces en pot

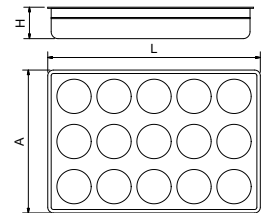

L	A	H	Gr	Barcode	€
354	245	55	350	487430	<b>54,00</b>

## Bandeja de exposición para helados polos

Display tray for ice poles

Plateau Présentoir pour glaces esquimaux

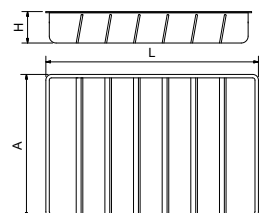

L	A	H	Gr	Barcode	€
354	245	55	350	487432	<b>33,00</b>

## Cubetas Gastronorm lisas

Non-perforated Gastronorm containers  
Bacs Gastronorm lisses



### Características:

Cubetas conforme a la norma EN 631, utilizadas para la preparación, cocción, congelación, descongelación y distribución de alimentos.

Fabricadas en acero inoxidable.

Posibilidad de encargar bajo pedido: Cubetas con asas, tapaderas con orificio para cuchara y tapaderas con junta hermética.

### Characteristics:

Set of containers normalized according to the norm EN 631, used for the preparation, cooking, freezing, defrosting and distribution of foodstuffs.

Made in stainless steel.

Possibility of make to order: container with handles, kitchen spoon lids, lids with hermetic joints.

### Caractéristiques:

Série de bacs normalisés selon la norme EN 631, utilisées pour la préparation, cuisson, surgélation, décongélation et distribution des aliments.

Fabriquées en acier inoxydable.

Possibilité de demander sur commande: bac avec poignées, couvercles avec découpage pour louche, couvercles avec joint hermétique.

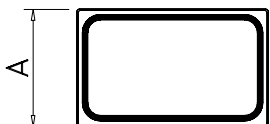
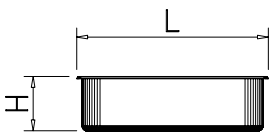

Modelo Model Model	L	A	H				€
1/1 - 20	530	325	20	2,75	1.100	486814	<b>21,00</b>
1/1 - 40	530	325	40	5,50	1.269	486816	<b>24,00</b>
1/1 - 65	530	325	65	9,50	1.365	486818	<b>27,00</b>
1/1 - 100	530	325	100	14,00	1.652	486820	<b>34,00</b>
1/1 - 150	530	325	150	21,00	1.965	486822	<b>50,00</b>
1/1 - 200	530	325	200	28,00	2.292	486824	<b>58,00</b>
1/2 - 20	325	265	20	1,38	475	486838	<b>12,00</b>
1/2 - 40	325	265	40	2,20	573	486840	<b>14,00</b>
1/2 - 65	325	265	65	3,70	663	486842	<b>16,00</b>
1/2 - 100	325	265	100	6,50	818	486844	<b>19,00</b>
1/2 - 150	325	265	150	9,50	944	486846	<b>30,00</b>
1/2 - 200	325	265	200	12,50	1.350	486848	<b>38,00</b>
1/3 - 20	325	176	20	0,90	317	486850	<b>10,80</b>
1/3 - 40	325	176	40	1,50	380	486852	<b>12,00</b>
1/3 - 65	325	176	65	2,50	488	486854	<b>14,00</b>
1/3 - 100	325	176	100	3,70	581	486856	<b>16,00</b>
1/3 - 150	325	176	150	5,70	698	486858	<b>24,00</b>
1/3 - 200	325	176	200	7,70	770	486860	<b>31,00</b>
1/4 - 20	265	162	20	0,69	236	486862	<b>9,90</b>
1/4 - 40	265	162	40	1,37	286	486864	<b>12,00</b>
1/4 - 65	265	162	65	1,60	355	486866	<b>13,00</b>
1/4 - 100	265	162	100	2,80	449	486868	<b>15,00</b>
1/4 - 150	265	162	150	4,20	559	486870	<b>21,00</b>
1/4 - 200	265	162	200	5,80	644	486872	<b>26,00</b>
1/6 - 20	176	162	20	0,46	167	486874	<b>8,50</b>
1/6 - 40	176	162	40	0,90	236	486876	<b>10,00</b>
1/6 - 65	176	162	65	1,00	267	486878	<b>10,50</b>
1/6 - 100	176	162	100	1,80	346	486880	<b>12,50</b>
1/6 - 150	176	162	150	2,40	398	486882	<b>17,00</b>
1/6 - 200	176	162	200	2,60	640	486884	<b>28,00</b>
1/9 - 65	176	108	65	0,50	195	486886	<b>10,00</b>
1/9 - 100	176	108	100	0,90	230	486888	<b>14,00</b>
2/1 - 20	650	530	20	5,70	2.726	486802	<b>54,00</b>
2/1 - 40	650	530	40	10,50	2.957	486804	<b>48,00</b>
2/1 - 65	650	530	65	18,50	3.255	486806	<b>65,00</b>
2/1 - 100	650	530	100	28,00	3.650	486808	<b>77,00</b>
2/1 - 150	650	530	150	42,00	4.230	486810	<b>106,00</b>
2/1 - 200	650	530	200	56,50	4.800	486812	<b>123,00</b>
2/3 - 20	354	325	20	1,85	708	486826	<b>16,00</b>
2/3 - 40	354	325	40	3,20	803	486828	<b>18,00</b>
2/3 - 65	354	325	65	5,50	830	486830	<b>19,00</b>
2/3 - 100	354	325	100	8,70	1.116	486832	<b>25,00</b>
2/3 - 150	354	325	150	13,00	1.380	486834	<b>41,00</b>
2/3 - 200	354	325	200	18,00	1.639	486836	<b>48,00</b>
2/4 - 20	530	162	20	1,37	550	486890	<b>14,00</b>
2/4 - 40	530	162	40	2,75	634	486892	<b>19,00</b>
2/4 - 65	530	162	65	4,75	682	486894	<b>22,00</b>
2/4 - 100	530	162	100	7,00	826	486896	<b>33,00</b>
2/4 - 150	530	162	150	10,50	982	486898	<b>43,00</b>

## Cubetas Gastronorm perforadas

Perforated Gastronorm containers  
Bacs Gastronorm perforé

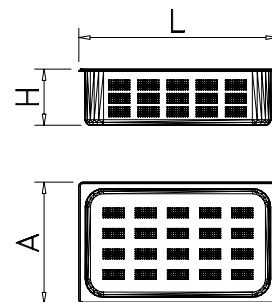

Modelo Model Model	L	A	H		Gr		€
1/1 - 40	530	325	40	5,50	1.320	487012	<b>27,00</b>
1/1 - 65	530	325	65	9,50	1.305	487014	<b>30,00</b>
1/1 - 100	530	325	100	14,00	1.570	487016	<b>39,00</b>
1/1 - 150	530	325	150	21,00	1.820	487018	<b>62,00</b>
1/1 - 200	530	325	200	28,00	2.053	487020	<b>73,00</b>
1/2 - 40	325	265	40	2,20	598	487032	<b>16,00</b>
1/2 - 65	325	265	65	3,70	660	487034	<b>18,00</b>
1/2 - 100	325	265	100	6,50	745	487036	<b>23,00</b>
1/2 - 150	325	265	150	9,50	890	487038	<b>37,00</b>
1/2 - 200	325	265	200	12,50	1.275	487040	<b>46,00</b>
2/1 - 40	650	530	40	10,50	2.764	487002	<b>59,00</b>
2/1 - 65	650	530	65	18,50	3.087	487004	<b>66,00</b>
2/1 - 100	650	530	100	28,00	3.480	487006	<b>89,00</b>
2/1 - 150	650	530	150	42,00	3.870	487008	<b>125,00</b>
2/1 - 200	650	530	200	56,50	4.480	487010	<b>143,00</b>
2/3 - 40	354	325	40	3,20	757	487022	<b>20,00</b>
2/3 - 65	354	325	65	5,50	790	487024	<b>22,00</b>
2/3 - 100	354	325	100	8,70	1.051	487026	<b>31,00</b>
2/3 - 150	354	325	150	13,00	1.278	487028	<b>48,00</b>
2/3 - 200	354	325	200	18,00	1.500	487030	<b>57,00</b>

## Tapas para cubetas Gastronorm

Lid for Gastronorm containers  
Couvercle pour bacs Gastronorm

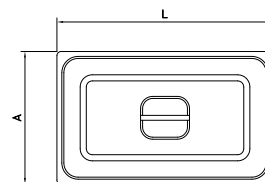

Modelo Model Model	L	A	Gr		€
1/1	530	325	1.100	487202	<b>21,00</b>
1/2	325	265	500	487206	<b>12,00</b>
1/3	325	176	350	487208	<b>9,00</b>
1/4	265	162	255	487210	<b>8,00</b>
1/6	176	162	180	487212	<b>7,00</b>
1/9	176	108	110	487214	<b>6,40</b>
2/3	354	325	662	487204	<b>15,00</b>
2/4	530	162	331	487216	<b>15,00</b>

## Tapa antidesbordamiento inox para cubeta GN gastronorm

Anti-overflow stainless steel lid for GN gastronorm containers  
Couvercle anti-débordement pour bac gastronorme



Modelo Model Model	Gr	Barcode	€
1/1	1150	487232	<b>59,00</b>
1/2	540	487234	<b>39,00</b>
1/3	380	487236	<b>30,00</b>
1/4	275	487238	<b>25,00</b>
1/6	195	487240	<b>23,00</b>
2/3	680	487242	<b>42,00</b>

## Doble fondo para cubeta gastronorm

Double bottom for GN container  
Double fond pour bac gastronorme

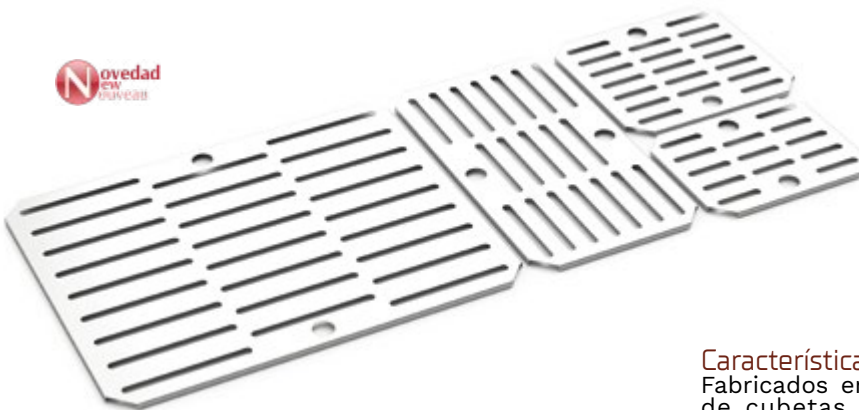

### Características:

Fabricados en acero inoxidable, estos doble fondos de cubetas GN perforados son óptimos para la conservación de aquellos alimentos que liberan líquido y/o jugos durante su conservación.

Estos dobles fondos impiden que los alimentos se conserven húmedos, aumentando así la duración de los mismos y, por lo tanto, reduciendo el desperdicio.

### Characteristics:

Made of stainless steel, this double bottom for GN container is optimal for preservation of those foods that release liquid or juices during their preservation.

This double bottom preserves food from a humid preservation to extend their lifespan and to reduce their waste.

### Caractéristiques:

Fabriqués en acier inoxydable, ces doubles fonds pour bacs GN perforés sont optimaux pour la conservation des aliments qui libèrent du liquide lors du stockage.

Ce double fond évite le maintien de l'humidité des aliments, augmentant ainsi leur durée et, par conséquent, la réduction des déchets.

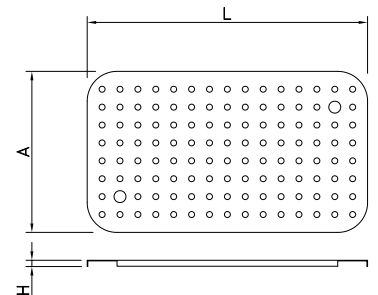

L	A	H	Modelo Model Model	Gr	Barcode	€
470	270	10	1/1	667	487252	<b>18,00</b>
270	210	10	1/2	316	487256	<b>12,00</b>
590	470	10	2/1	1.512	487250	<b>32,00</b>
300	270	10	2/3	438	487254	<b>14,00</b>



BPA o Bisphenol A es una sustancia tóxica presente en algunas cubetas, biberones y otros elementos de plástico. Se libera principalmente al calentar estos productos tanto en microondas o al esterilizarlos en agua de manera convencional. BPA FREE garantiza que este producto no está fabricado con BPA.

BPA or Bisphenol A is a toxic substance that is present in some containers, feeding bottles and other plastic elements. It is particularly released when these materials are heated in a microwave or conventionally sterilized in water. BPA FREE guarantees that this product does not contain BPA.

BPA ou Bisphénol A est une substance toxique qui est présent dans certains bacs, biberons et des autres éléments en plastique. Il est particulièrement libérée lorsque ces produits sont chauffés dans un four micro-ondes ou sont stérilisés dans l'eau de façon conventionnelle. BPA FREE garantit que ce produit ne contient pas de BPA.

## Cubetas Gastronorm copoliéster

Gastronorm containers in copolyester  
Bacs Gastronorm en copolyester



Ver pag. 438  
See page 438  
Voir page 438

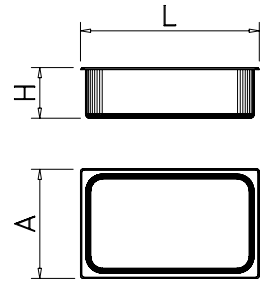

Modelo Model Model	L	A	H				€
1/1 - 65	530	325	65	9,50	700	487604	<b>23,00</b>
1/1 - 100	530	325	100	14,00	800	487606	<b>29,10</b>
1/1 - 150	530	325	150	21,00	980	487608	<b>34,30</b>
1/1 - 200	530	325	200	28,00	1.145	487610	<b>42,30</b>
1/2 - 65	325	265	65	3,70	330	487612	<b>13,50</b>
1/2 - 100	325	265	100	6,50	410	487614	<b>13,90</b>
1/2 - 150	325	265	150	9,50	470	487616	<b>17,00</b>
1/2 - 200	325	265	200	12,50	675	487618	<b>21,30</b>
1/3 - 65	325	176	65	2,50	240	487620	<b>10,60</b>
1/3 - 100	325	176	100	3,70	290	487622	<b>12,40</b>
1/3 - 150	325	176	150	5,70	350	487624	<b>15,20</b>
1/3 - 200	325	176	200	7,70	390	487626	<b>18,00</b>
1/4 - 65	265	162	65	1,60	180	487628	<b>8,60</b>
1/4 - 100	265	162	100	2,80	230	487630	<b>10,00</b>
1/4 - 150	265	162	150	4,20	280	487632	<b>12,00</b>
1/4 - 200	265	162	200	5,80	325	487634	<b>15,00</b>
1/6 - 65	176	162	65	1,00	135	487636	<b>6,40</b>
1/6 - 100	176	162	100	1,80	175	487638	<b>7,40</b>
1/6 - 150	176	162	150	2,40	200	487640	<b>9,30</b>
1/6 - 200	176	162	200	2,60	325	487642	<b>11,50</b>
1/9 - 65	176	108	65	0,50	100	487644	<b>5,00</b>
1/9 - 100	176	108	100	0,90	120	487646	<b>6,20</b>
2/1 - 200	650	530	200	56,50	2.400	487602	<b>81,00</b>





## Tapas para cubetas Gastronorm copoliéster

Lids for Gastronorm containers in copolyester  
Couvercle pour bacs Gastronorm en copolyester



Ver pag. 438  
See page 438  
Voir page 438

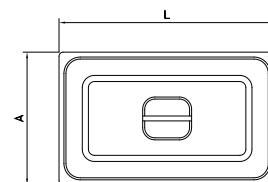

Modelo Model Model	L	A	Gr	Barcode	€
1/1	530	325	660	487220	<b>18,00</b>
1/2	325	265	300	487222	<b>10,00</b>
1/3	325	176	210	487224	<b>7,00</b>
1/4	265	162	153	487226	<b>6,00</b>
1/6	176	162	110	487228	<b>5,00</b>
1/9	176	108	70	487229	<b>4,00</b>
2/1	650	530	920	487218	<b>46,00</b>

## Tapa hermética GN de copoliéster BPA-Free

Copolyester BPA-Free GN hermetic lid  
Couvercle hermétique GN en copolyester BPA-Free



Ver pag. 438  
See page 438  
Voir page 438

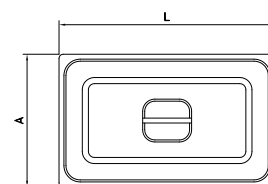

Modelo Model Model	L	A	Kg	Barcode	€
1/1	325	530	0,66	487244	<b>16,00</b>
1/2	325	265	0,30	487245	<b>9,00</b>
1/3	325	175	0,21	487246	<b>7,40</b>
1/4	264	162	0,15	487247	<b>5,30</b>
1/6	176	162	0,11	487248	<b>4,00</b>
1/9	176	108	0,07	487249	<b>3,30</b>

## Fondos perforados para cubetas Gastronorm copoliéster

Perforated bottom for Gastronorm containers in copolyester  
Fond pour bacs Gastronorm en copolyester



Ver pag. 438  
See page 438  
Voir page 438

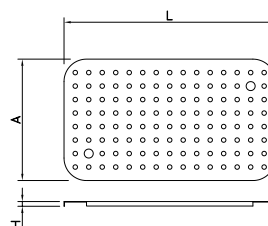

Modelo Model Model	L	A	H	Gr	Barcode	€
1/1	468	264	16	550	487260	<b>11,00</b>
1/2	264	204	16	250	487262	<b>6,40</b>
2/1	568	448	16	200	487258	<b>27,00</b>



## Cubetas Gastronorm alta temperatura

Gastronorm containers high temperatures  
Bacs Gastronorm hautes températures



Ver pag. 438  
See page 438  
Voir page 438

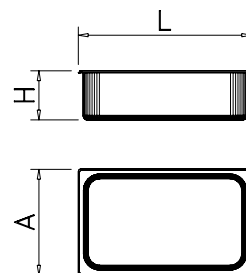

### Características:

Fabricado con materiales de conformidad con la FDA.  
Cumple con la normativa UNE EN 631-1.

BPA Free.

Sus principales cualidades son su gran resistencia a los golpes, identificación cómoda del contenido al poder ver a través de ellas, equipadas con una escala graduada con el sistema métrico y americano, preparadas para ser apiladas, fácil de limpiar, higienizables.

Resistentes a temperaturas de -40°C a +150°C.

Ideales para hornos microondas, baño maría etc.

### Characteristics:

Made with FDA-approved materials.

Designed and manufactured in compliance with the UNE EN 631-1.

Free of Bisphenol A BPA Free.

The type of materials and thicknesses of the containers guarantee a perfect shock-resistance; they cannot easily be dented in case of accidental spills.

Completely smooth walls which allows for easily identification of the internal content and facilitates easy washing.

Equipped with a graded scale according both the metric and American system.

Edges for easy stacking.

Available with easy to place over lids.

Easy to clean and sanitizable.

Can withstand temperatures from -40 °C +150 °C.

Ideal for microwave ovens, bain-marie and general warming facilities.

### Caractéristiques:

Fabriqué à la conformité de la FDA.

Conforme à la norme UNE EN 631-1.

BPA Free.

Ses principales qualités sont sa haute résistance aux chocs, l'identification du contenu pratique de pouvoir voir à travers eux, avec un gradient équipé d'un système métrique et américain, prêt à être empilés, facile à nettoyer, à l'échelle de higienizables.

Résistant de -40°C à +150°C. Température.

Ideal pour les fours à micro-ondes, des bains d'eau, etc..

Modelo Model Model	L	A	H		Gr		€
1/1 - 65	530	325	65	9,50	1.365	488002	<b>52,00</b>
1/1 - 100	530	325	100	14,00	1.652	488004	<b>67,00</b>
1/1 - 150	530	325	150	21,00	1.965	488006	<b>77,00</b>
1/2 - 65	325	265	65	3,70	663	488008	<b>33,00</b>
1/2 - 100	325	265	100	6,50	818	488010	<b>38,00</b>
1/2 - 150	325	265	150	9,50	944	488012	<b>45,00</b>
1/3 - 65	325	176	65	2,50	488	488014	<b>24,00</b>
1/3 - 100	325	176	100	3,70	581	488016	<b>30,00</b>
1/3 - 150	325	176	150	5,70	698	488018	<b>37,00</b>
1/4 - 65	265	162	65	1,60	355	488020	<b>19,00</b>
1/4 - 100	265	162	100	2,80	449	488022	<b>23,00</b>
1/4 - 150	265	162	150	4,20	559	488024	<b>29,00</b>
1/6 - 65	176	162	65	1,00	267	488026	<b>14,00</b>
1/6 - 100	176	162	100	1,80	346	488028	<b>17,50</b>
1/6 - 150	176	162	150	2,40	398	488030	<b>22,00</b>
1/9 - 65	176	108	65	0,50	195	488032	<b>9,90</b>
1/9 - 100	176	108	100	0,90	230	488034	<b>11,50</b>

## Tapas para cubetas Gastronorm alta temperatura

Lids for Gastronorm containers high temperatures  
Couvercle pour bacs Gastronorm hautes températures



Ver pag. 438  
See page 438  
Voir page 438

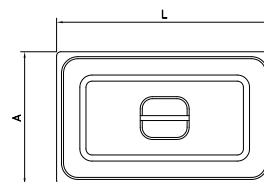

Modelo Model Model	L	A	Gr		€
1/1	530	325	1.100	488070	<b>46,00</b>
1/2	325	265	500	488072	<b>24,00</b>
1/3	325	176	350	488074	<b>17,00</b>
1/4	265	162	255	488076	<b>13,30</b>
1/6	176	162	180	488078	<b>10,50</b>
1/9	176	108	110	488080	<b>6,50</b>

## Cubetas GN para identificación de alérgenos

Gastronorm containers for allergen marking  
Cuvettes GN pour identification d'allergènes

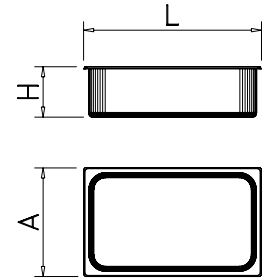

### Características:

La línea de cubetas GN para identificación de alérgenos es el aliado ideal para cualquier establecimiento en el que se manipulen alimentos, ya que incorporan pictogramas de los posibles alérgenos y bastará con marcar con un rotulador (de borrado en húmedo) el tipo de alérgeno que contiene para su identificación. El recipiente se podrá reutilizar una vez lavado en lavavajillas pues tanto la tinta como los alérgenos habrán desaparecido.

Con este sistema se puede garantizar la información que proporcionar a clientes/usuarios, cumpliendo así con la normativa EU 1169/2011, que tiene como objetivo garantizar un elevado nivel de protección del consumidor en el campo de información de alimentos. Este Reglamento introduce, entre otras cosas, la obligación de los restaurantes a proporcionar información detallada a los clientes sobre la presencia de sustancias alergénicas contenidas en los alimentos.

### Characteristics:

The line of GN trays for allergen identification will be the best resource for your business when processing food, since they incorporate easy to mark pictograms of any eventual allergen. As quick and easy as marking with a marker pen of wet erase the type of allergen it contains for a proper identification. The container can be reused once washed in the dishwasher as both the mark and the allergens will disappear.

Through this system you will provide your customers / users guaranteed information, thus complying with the EU 1169/2011 regulation, which aims to guarantee a high level of consumer protection in the field of food information. This Regulation introduces, among other things, the obligation of restaurants to provide detailed information to customers on the presence of allergenic substances contained in food.

### Caractéristiques:

La gamme de bac GN pour l'identification des allergènes est l'allié idéal pour tout établissement où sont manipulés des aliments puisqu'ils intègrent des pictogrammes des allergènes possibles et il suffira de marquer avec un marqueur (effacement humide) le type d'allergène qu'il contient à votre identifiant. Le contenant peut être réutilisé une fois qu'il a été lavé au lave-vaisselle car l'encre et les allergènes auront disparu.

Avec ce système, les informations à fournir aux clients / utilisateurs peuvent être garanties, respectant ainsi le règlement UE 1169/2011, qui vise à garantir un niveau élevé de protection des consommateurs dans le domaine de l'information sur les denrées alimentaires. Ce règlement introduit, entre autres, l'obligation pour les restaurants de fournir des informations détaillées aux clients sur la présence de substances allergènes contenues dans les denrées alimentaires.

Modelo Model Model	L	A	H	Gr	Gr	Barcode	€
1/1 - 65	530	325	65	9,00	700	488402	<b>12,90</b>
1/1 - 100	530	325	100	13,30	800	488404	<b>14,10</b>
1/1 - 150	530	325	150	20,00	980	488406	<b>15,90</b>
1/1 - 200	530	325	200	26,40	1.145	488408	<b>19,80</b>
1/2 - 65	325	265	65	4,00	330	488410	<b>7,80</b>
1/2 - 100	325	265	100	6,10	410	488412	<b>8,50</b>
1/2 - 150	325	265	150	9,00	470	488414	<b>10,40</b>
1/2 - 200	325	265	200	11,90	975	488416	<b>12,20</b>
1/3 - 65	325	176	65	2,50	240	488418	<b>5,60</b>
1/3 - 100	325	176	100	3,80	290	488420	<b>7,40</b>
1/3 - 150	325	176	150	5,50	350	488422	<b>9,00</b>
1/3 - 200	325	176	200	7,10	390	488424	<b>10,50</b>
1/4 - 65	265	162	65	1,70	180	488426	<b>5,95</b>
1/4 - 100	265	162	100	2,60	230	488428	<b>6,45</b>
1/4 - 150	265	162	150	3,80	280	488430	<b>7,95</b>
1/4 - 200	265	162	200	4,80	325	488432	<b>9,20</b>
1/6 - 65	176	162	65	1,00	135	488434	<b>4,90</b>
1/6 - 100	176	162	100	1,60	175	488436	<b>5,50</b>
1/6 - 150	176	162	150	2,30	200	488438	<b>5,60</b>
1/6 - 200	176	162	200	2,80	325	488440	<b>7,00</b>
1/9 - 65	176	108	65	0,60	100	488442	<b>4,20</b>
1/9 - 100	176	108	100	0,90	120	488444	<b>4,65</b>

## Tapa para cubetas GN para identificación de alérgenos

Lid for Gastronorm containers for allergen marking  
Couvercle pour Cuvettes GN pour identification d'allergènes

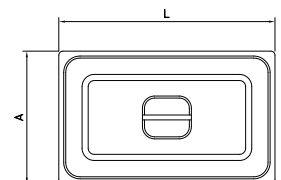

Modelo Model Model	L	A	Gr	Barcode	€
1/1	530	325	660	488460	<b>6,50</b>
1/2	325	265	300	488462	<b>3,70</b>
1/3	325	176	210	488464	<b>3,00</b>
1/4	265	162	153	488466	<b>2,65</b>
1/6	176	162	110	488468	<b>2,30</b>
1/9	176	108	70	488470	<b>2,15</b>

## Recipientes de polipropileno

Containers in polypropylene  
Bacs en polypropylene

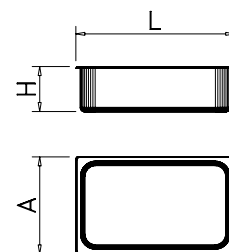

### Características:

Fabricadas con materiales en conformidad con la FDA.

Solución económica para la preparación, almacenamiento y exposición de los alimentos.

Buena transparencia que permite fácilmente la identificación del contenido interior.

Resistente a temperaturas de -40°C a +80°C.

Equipado con una escala graduada con los sistemas métrico y estadounidense.

Apilables.

### Characteristics:

Made with FDA-approved materials.

Excellent economical solution for the preparation, display and storage of food.

Excellent shock resistance at room temperature.

Good transparency allowing easily identification of the inside contents. Can withstand temperatures from -40 °C to +80 °C.

Equipped with a graded scale according both the American and metric systems.

Edges for easy stacking.

### Caractéristiques:

Fabriqué avec des matériaux conformes à la FDA.

Solution économique pour la préparation, le stockage et l'affichage de la nourriture.

Bonne transparence qui permet l'identification facile du contenu à l'intérieur.

Résistant à des températures de -40°C à +80°C.

Équipé d'un diplôme de niveau des systèmes métrique et US.

Empilable.

Modelo Model Model	L	A	H	Gr	Gr	Barcode	€
1/1 - 65	530	325	65	9,50	700	488202	<b>10,00</b>
1/1 - 100	530	325	100	14,00	800	488204	<b>11,80</b>
1/1 - 150	530	325	150	21,00	980	488206	<b>14,60</b>
1/1 - 200	530	325	200	28,00	1.145	488208	<b>16,70</b>
1/2 - 65	325	265	65	3,70	330	488210	<b>6,40</b>
1/2 - 100	325	265	100	6,50	410	488212	<b>7,70</b>
1/2 - 150	325	265	150	9,50	470	488214	<b>8,30</b>
1/2 - 200	325	265	200	12,50	675	488216	<b>8,80</b>
1/3 - 65	325	176	65	2,50	240	488218	<b>5,80</b>
1/3 - 100	325	176	100	3,70	290	488220	<b>6,00</b>
1/3 - 150	325	176	150	5,70	350	488222	<b>6,70</b>
1/3 - 200	325	176	200	7,70	390	488224	<b>7,80</b>
1/4 - 65	265	162	65	1,60	180	488226	<b>4,90</b>
1/4 - 100	265	162	100	2,80	230	488228	<b>5,30</b>
1/4 - 150	265	162	150	4,20	280	488230	<b>6,00</b>
1/4 - 200	265	162	200	5,80	325	488232	<b>8,60</b>
1/6 - 65	176	162	65	1,00	135	488234	<b>4,20</b>
1/6 - 100	176	162	100	1,80	175	488236	<b>4,30</b>
1/6 - 150	176	162	150	2,40	200	488238	<b>5,00</b>
1/6 - 200	176	162	200	2,60	325	488240	<b>7,50</b>
1/9 - 65	176	108	65	0,50	100	488242	<b>4,00</b>
1/9 - 100	176	108	100	0,90	120	488244	<b>4,10</b>

## Tapas para recipientes de polipropileno

Lids for containers in polypropylene  
Couvercles pour bacs en polypropylene

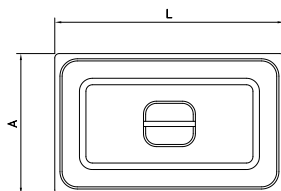

Modelo Model Model	L	A	Gr	Barcode	€
1/1	530	325	660	488270	<b>5,70</b>
1/2	325	265	300	488272	<b>3,90</b>
1/3	325	176	210	488274	<b>3,50</b>
1/4	265	162	153	488276	<b>3,00</b>
1/6	176	162	110	488278	<b>2,90</b>
1/9	176	108	70	488280	<b>2,90</b>

## Fondos perforados para recipientes de polipropileno

Perforated bottoms for containers in polypropylene  
Fonds pour bacs en polypropylene

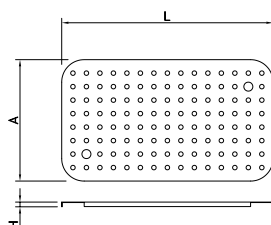

Modelo Model Model	L	A	H	Gr	Barcode	€
1/1	468	264	16	550	487268	<b>5,00</b>
1/2	264	204	16	250	487269	<b>3,40</b>

## Tapa hermética GN de polipropileno BPA-Free

Polypropylene BPA-Free GN hermetic lid

Couvercle hermétique GN en polypropylène BPA-Free



### Características:

Tapas herméticas para uso alimentario, fabricadas en polipropileno transparente. Este material es la alternativa perfecta al policarbonato, ya que está completamente libre de Bisphenol A (BPA-Free).

La transparencia de este material facilita la identificación del contenido del recipiente sin necesidad de apertura. Además tienen una gran resistencia anticorrosión y ante posibles colisiones.

La tapa incorpora una junta que posibilita el cierre hermético del recipiente, lo que favorece a preservar los alimentos más frescos durante más tiempo, así como evitar la apertura involuntaria de la tapa, evitando por lo tanto desperdicios involuntarios.

Disponibles para los diferentes tamaños de cubetas GN.

### Characteristics:

Hermetic covers for food use, manufactured in polypropylene. This material is the perfect alternative to polycarbonate, since it is completely free of Bisphenol A (BPA-Free).

Hermetic sealed lids for food use, made of transparent polycarbonate. The transparency of this material facilitates the identification of the content without opening the container. They also have a high resistance to corrosion and to possible collisions.

The incorporated seal allows the container to be hermetic, which helps to preserve the freshest foods for a longer time, as well as to avoid the inadvertent opening of the lid, thus avoiding involuntary waste.

Available for different sizes of GN buckets

### Caractéristiques:

Couvercles hermétiques à usage alimentaire en polypropylène. Ce matériau est l'alternative parfaite au polycarbonate, car il ne contient pas de bisphénol A (sans BPA)

La transparence de ce matériau facilite l'identification du contenu du récipient sans nécessité d'ouverture. Ils ont également une grande résistance à la corrosion et aux possibles collisions.

Le couvercle comporte un joint qui permet la fermeture hermétique du récipient, ce qui favorise la conservation des aliments plus frais pendant une période prolongée, tout en évitant l'ouverture involontaire du couvercle, évitant ainsi les pertes involontaires.

Disponible pour les différentes tailles de cuvettes GN.

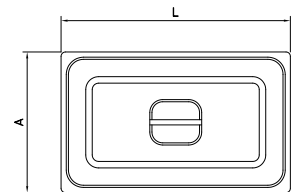

Modelo Model Model	L	A	Gr	Barcode	€
1/1	530	325	660	488282	<b>15,10</b>
1/2	325	265	300	488284	<b>10,90</b>
1/3	325	175	210	488286	<b>7,90</b>
1/4	264	162	153	488288	<b>6,00</b>
1/6	176	162	110	488290	<b>5,90</b>
1/9	176	108	70	488292	<b>5,30</b>



## Tapas de polipropileno GN de colores

Polypropylene colored Gastronorm lids  
Couvercles en polypropylène GN plusieurs couleurs

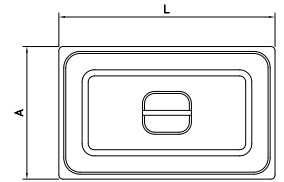

Modelo Model Model	L	A	Gr			€
1/1	530	325	660		488302	<b>5,70</b>
					488304	
					488306	
					488308	
1/2	325	265	300		488310	<b>3,90</b>
					488312	
					488314	
					488316	
1/3	325	176	210		488318	<b>3,50</b>
					488320	
					488322	
					488324	
1/4	265	162	153		488326	<b>3,00</b>
					488328	
					488330	
					488332	
1/6	176	162	110		488334	<b>2,90</b>
					488336	
					488338	
					488340	
1/9	176	108	70		488342	<b>2,85</b>
					488344	
					488346	
					488348	

## Rejillas Gastronorm de acero inoxidable

Gastronorm grilles of stainless steel  
Grilles gastronorm en acier inoxydable

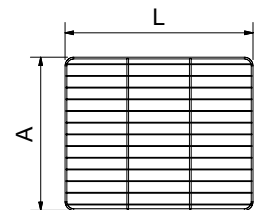
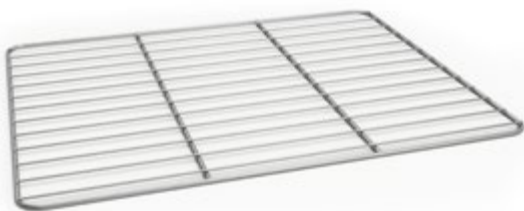

Modelo Model Model	L	A	Gr Kg	Kg		€
1/1	530	325	45	0,89	487272	<b>32,00</b>
1/2	325	265	31	0,48	487274	<b>21,00</b>
2/1	650	530	71	1,97	487270	<b>52,00</b>
Euronorm	600	400	17	0,88	487276	<b>30,00</b>

## Perfiles divisorios para cubetas Gastronorm

Dividing section for Gastronorm containers  
Profil diviseur pour bacs Gastronorm

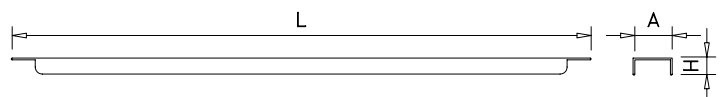

L	A	H	Gr		€
325	22	9,8	86	082820	<b>5,00</b>
530	22	9,8	146	082822	<b>6,00</b>

## Escurridor inox para cubetas Gastronorm

GN container rack in stainless steel  
Égouttoir inox pour bac Gastronorm



**N**ovedad  
en  
nouveauté



Fabricado en acero inoxidable, este escurridor para cubetas gastronorm será nuestro mayor aliado a la hora de eliminar el líquido excedente de nuestros recipientes.

Made of stainless steel, this rack for GN containers will be your best partner when draining the remaining liquids from our containers.

Fabriqué en acier inoxydable, cet égouttoir pour bac gastronorm sera notre meilleur allié lorsqu'il s'agira d'éliminer l'excès de liquide de nos récipients.

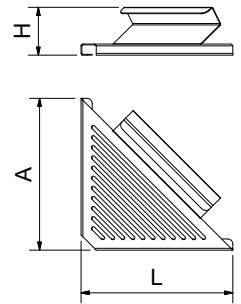

L	A	H	Gr	Barcode	€
150	150	47	130	082824	<b>9,00</b>

## Soporte para tapa de cubeta Gastronorm

GN lid holder  
Support pour couvercle de bac Gastronorm

**N**ovedad  
en  
nouveauté



Fabricado en acero inoxidable, este soporte para tapa de cubeta GN es ideal para mantener las cubetas abiertas sin la necesidad de buscarles una ubicación específica. Gracias a este utensilio, cada tapa quedará correctamente situada en cada cubeta, lo que evitará la posibilidad de mezclar las tapas de unos recipientes con otros y por lo tanto de producir algún tipo de contaminación cruzada.

Made of stainless steel, this holder for GN lids is ideal to keep the containers open, no matter where they are. Thanks to this tool, every lid will be in the right position on every container, which will avoid any possibility of mixing one lid with another container that could provoke cross contamination.

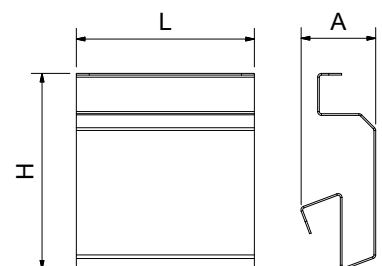

Fabriqué en acier inoxydable, ce support pour couvercle de bac GN est idéal pour maintenir les bacs ouverts sans avoir besoin de leur trouver un emplacement spécifique. Grâce à cet outil, chaque couvercle sera correctement placé dans chaque bac, ce qui évitera la possibilité de mélanger les couvercles de certains récipients avec d'autres et donc de produire un certain type de contamination croisée.

L	A	H	Gr	Barcode	€
83	35	91	105	082826	<b>9,00</b>

**Asa universal para cubetas Gastronorm**  
Standard handle for Gastronorm containers  
Manche universel pour bacs Gastronorm

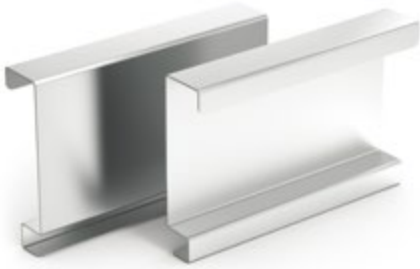

Introducing the fastest, safest and cleanest way to place and remove insert pans at your food service facilities.

A tool that ends the injuries and food contamination that may occur when kitchen staff and food servers switch out pans at steam tables and buffet lines.  
Heavy gauge stainless steel construction.  
Pan removers lock-on when pushed inward and won't slip, allowing a steady and safe handling.  
Prevents burns and pinched or broken fingers at hot tables.  
Prevents food contamination.  
Easy to use.  
Dishwasher safe.



Nous présentons la forme la plus rapide, seure, et propre de placer et retirer cuveaux dans vos équipements de restauration.

Un outil qui finit avec les accidents et avec la contamination alimentaire qu'il peut se produire quand les cuisiniers et serveurs retirent des cuveaux du bain-marie et des buffets.  
Construction en acier inoxydable à grand épaisseur.  
L'anse se bloque quand est pressé vers dehors et ne se glisse pas.  
Prévient des brûlures et des doigts coincés dans les tables chaudes.  
Prévient la contamination alimentaire.  
Facile à user.  
Bon pour le lave-vaisselles.

Presentamos la forma más rápida, segura y limpia de colocar y retirar cubetas de sus equipamientos de restauración.

Una herramienta que acaba con los accidentes y con la contaminación alimentaria que pueden producirse cuando cocineros y camareros sacan cubetas de los baños maría y buffets.  
Construcción en acero inoxidable de gran espesor.  
El asa se bloquea cuando es presionada hacia dentro y no se desliza, garantizando una maniobrabilidad firme y segura.  
Previene quemaduras y dedos aplastados en las mesas calientes.

Previene la contaminación alimentaria.  
Fácil de usar.  
Apto para lavavajillas.



 El precio es por pareja.  
The pair is included in the price.  
Le paire est inclus dans de prix.

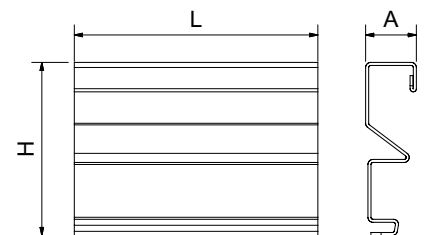

L	A	H	Gr	Barcode	€
120	22	80	200	082802	<b>5,00</b>

**Fiambrrera de cristal con tapa hermética**  
Glass lunch box with airtight lid  
Boîte à lunch en verre avec couvercle hermétique

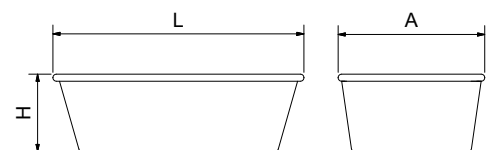

L	A	H	ml	Gr	Barcode	€
160	110	60	0,42	374	488602	<b>5,00</b>
225	160	85	1,50	1.000	488604	<b>11,00</b>



## Bandejas de presentación inox

Stainless steel presentation trays  
Plateaux de présentation en acier inoxydable

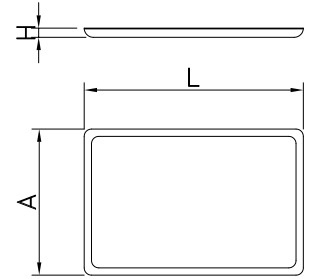

L	A	H	Gr	Barcode	€
320	220	20	530	480676	<b>8,60</b>
360	270	20	670	480677	<b>9,00</b>
400	300	20	820	480678	<b>9,50</b>
500	350	20	1.280	480679	<b>11,00</b>

## Bandejas de presentación

Presentation trays  
Plateaux de présentation

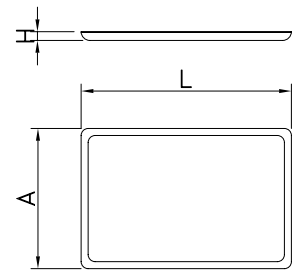

L	A	H	Color	Gr	Barcode	€
280	190	12	Black	150	480694 480692	<b>6,00</b>
350	240	12	Black	220	480732 480730	<b>9,00</b>
420	300	12	Black	340	480752 480750	<b>12,00</b>
600	400	25	Black	1.100	----- 480690	<b>20,00</b>

## Bandejas de presentación BP2

Presentation tray BP2  
Plateau de présentation BP2



Material polipropileno 100% alimentario.  
Polypropylene material, totally food-safe.  
Matériaux 100% polypropylène.

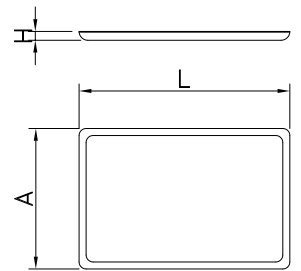

L	A	H	Gr	Barcode	€
430	310	31	400	480740	<b>5,30</b>

## Bandeja Gastronorm de presentación BP3

Gastronorm presentation tray BP3  
Plateau Gastronorm de présentation BP3



Material polipropileno 100% alimentario.  
Polypropylene material, totally food-safe.  
Matériaux 100% polypropylène.

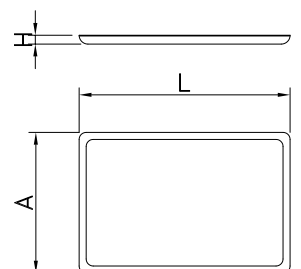

L	A	H	Gr	Barcode	€
530	325	14	600	480770	<b>15,00</b>

### Bandeja Euronorm autoservicio en polipropileno azul

Euronorm self-service tray in blue polypropylene  
Plateau libre-service Euronorm en polypropylène bleu

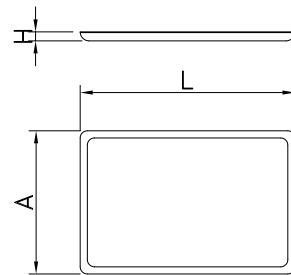

L	A	H	Gr	Barcode	€
530	370	26	150	480698	12,00

### Bandeja Euronorm autoservicio en polipropileno azul con asas

Euronorm self-service tray in blue polypropylene with handles  
Plateau libre-service Euronorm en polypropylène bleu avec poignées

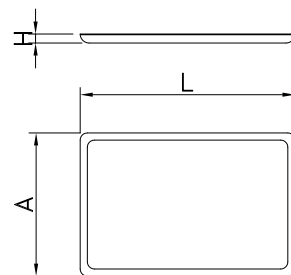

L	A	H	Gr	Barcode	€
530	370	21	160	480699	12,00

### Bandeja inoxidable con asa

Stainless steel tray with handle  
Plateau en acier inoxydable avec manche

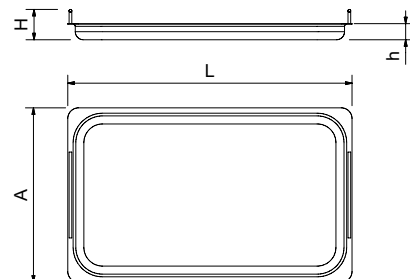

Modelo Model Model	L	A	H	h	Gr	Barcode	€
1/1	530	325	60	20	1.300	480672	48,00
2/1	650	530	60	20	2.920	480670	75,00
2/3	354	325	60	20	900	480674	41,00

### Bandeja menú inoxidable

Stainless steel menu trays  
Plateau repas en acier inoxydable

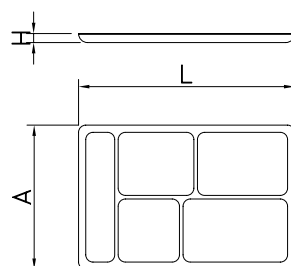

L	A	H	Gr	Barcode	€
400	300	30	4	844 482802	28,00
440	350	30	5	1.106 482804	31,00

### Bandeja de comedor autoservicio inox

Stainless steel self-service dining tray  
Plateau de repas libre-service en acier inoxydable

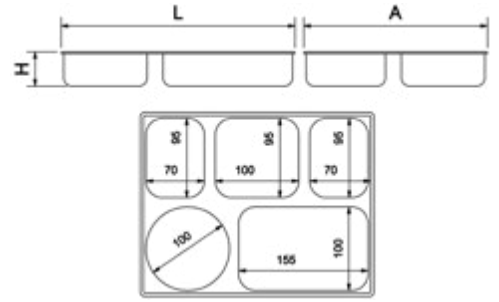

L	A	H	Gr	Barcode	€
280	220	40	5	482806	10,00

### Bandeja isotérmica polipropileno Euronorm 1/1 para colectividades 5 compartimentos

Isothermal meal distribution tray in polypropylene with lid, 5 compartments.  
Plateau repas isotherme en polypropylène avec couvercle 5 compartiments

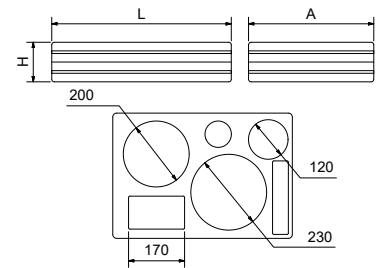

L	A	H	Gr	Kg	Barcode	€
545	370	120	5	3,0	482810	91,00

### Bandejas de camarero de acero inoxidable

Stainless steel waiter trays  
Plateaux de serveur en acier inoxydable

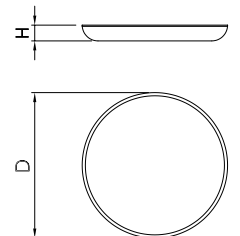

D	H	Gr	Barcode	€
310	20	350	480640	38,00
360	20	600	480642	44,00
410	20	800	480644	57,00

### Bandeja de camarero de acero inoxidable especial jarras de cerveza

Stainless steel trays for beer  
Plateau garçon de café en acier inoxydable spécial pour pichet de bière

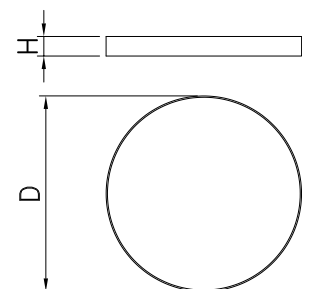

D	H	Gr	Barcode	€
300	30	560	480646	39,00
400	40	920	480648	57,00

**Bandeja de cambio sencilla**  
Simple change tray  
Porte-pourboire simple

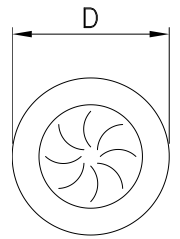

D	Gr	Barcode	€
120	10	486230	<b>1,40</b>

**Bandeja de cambio**  
Change tray  
Porte-pourboire

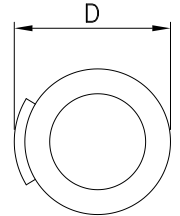

D	Gr	Barcode	€
130	11	486234	<b>2,31</b>

**Bandeja de cambio rectangular con clip**  
Rectangular change tray  
Porte-pourboire rectangulaire avec clip

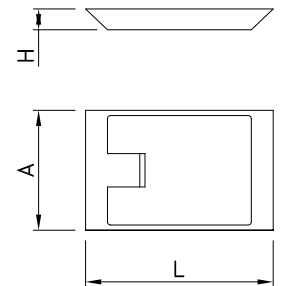

L	A	H	Gr	Barcode	€
180	115	20	20	486232	<b>2,31</b>

**Bandejas aluminio antiadherente**  
Non-stick aluminium tray  
Plateaux aluminium anti-adhérent

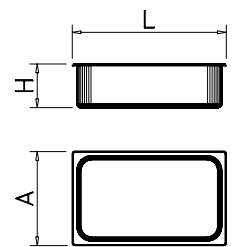

Modelo Model Model	L	A	H	Gr	Barcode	€
1/1	530	325	20	720	480702	<b>44,00</b>
1/1	530	325	40	800	480704	<b>51,00</b>
1/1	530	325	65	880	480706	<b>56,00</b>
2/3	354	325	20	510	480708	<b>34,00</b>
2/3	354	325	40	570	480710	<b>38,00</b>
2/3	354	325	65	650	480712	<b>44,00</b>
1/2	325	265	20	420	480714	<b>28,00</b>
1/2	325	265	40	450	480716	<b>32,00</b>
1/2	325	265	65	520	480718	<b>36,00</b>

**Bandeja pastelera en acero inoxidable**  
 Stainless steel baking tray  
 Plateau à pâtisserie en acier inoxydable



**No diseñadas para contener líquidos**  
 Not intended to contain liquids  
 Ne sont pas conçus pour contenir des liquides

**Bordes doblados a 90°**  
 Edges bent at 90°  
 Rebord aplati à 90°

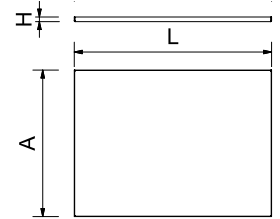

L	A	H	Kg	Barcode	€
300	400	9,5	0,8	083402	<b>18,00</b>
600	400	14,0	1,7	083404	<b>27,00</b>

**Bandeja pastelera perforada**  
 Perforated pastry baking tray  
 Plaque pâtisseries perforée



**Aluminio reforzado AG5**  
 Espesor 1,5 mm  
 4 esquinas a 45°  
 Perforaciones de Ø 6 mm.

AG5 hard aluminium  
 4 edges at 45°  
 Thickness 1,5 mm  
 With Ø 6 mm perforation

Aluminium AG5 dur  
 Epaisseur 1,5 mm  
 4 bords à 45°  
 Avec perforation Ø 6

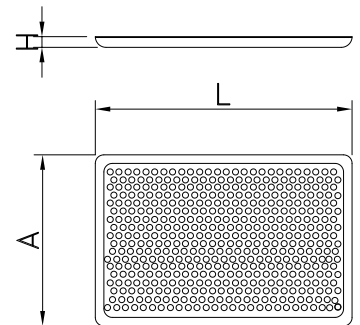

L	A	H	Gr	Barcode	€
605	405	30	500	480630	<b>19,00</b>

**Bandeja de panadería acanalada en aluminio 600x400 mm.**  
 Baguette aluminum baking tray 600x400 mm.  
 Plateau de boulangerie ondulé en aluminium 600x400 mm.



**Base de chapa perforada.**  
 5 canales longitudinales.  
 Antiadherente.  
 1 mm de espesor

Perforated sheet base.  
 5 longitudinal channels.  
 Nonstick.  
 1 mm thick.

Base en tôle perforée.  
 5 canaux longitudinaux.  
 Antiadhésif.  
 1 mm d'épaisseur.

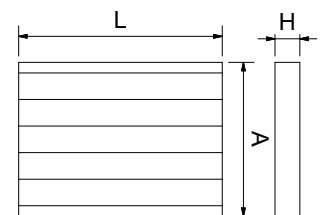

L	A	H	Bread Icon	Kg	Barcode	€
400	600	45	5	1,0	480634	<b>45,00</b>

**Bandeja para marisco**  
Seafood tray  
Plateau inox pour fruits de mer



**Características:**

Sistema modular para un perfecto acoplamiento y organización de la exposición del género en el mostrador de pescadería. Provista de agujeros a modo de desagüe. Construida totalmente en acero inoxidable.

**Characteristics:**

Modular system for a perfect fit and rack of the commodities displayed on the fish counter. Provided with holes for drainage. Made entirely of stainless steel.

**Caractéristiques:**

Système modulaire pour l'organisation de la fruits de mer sur l'étal à poisson. Avec trous pour le drainage. Fabriqué totalement en acier inoxydable.

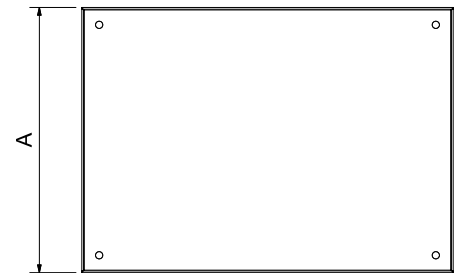
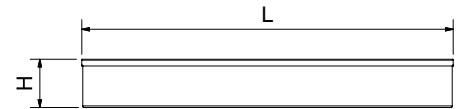

L	A	H	Kg	Barcode	€
480	287	50	1,35	083420	<b>39,00</b>

**Caja de reparto/distribución apilable con tapa**  
Stackable distribution box with lid  
Boîte de distribution empilable avec couvercle

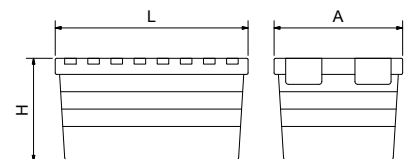

L	A	H	H	Kg	Barcode	€
600	400	320	60	2,90	483030	<b>34,00</b>
600	400	360	66	3,55	483034	<b>36,00</b>
600	400	410	77	3,75	483032	<b>39,00</b>

**Contenedor Gastronorm aislamiento térmico**  
 Gastronorm container for thermic isolation  
 Bac Gastronorm d'isolation thermique



Modelo Model Model	L	A	H	Gr	Barcode	€
1/1 - 120	600	400	170	550	487802	<b>69,00</b>
1/1 - 170	600	400	230	620	487804	<b>74,00</b>
1/1 - 220	600	400	270	710	487806	<b>82,00</b>

**Placa eutéctica GN 1/1 acumulador de frío de 0 a -21°C**  
 Eutectic plate GN 1/1 cold accumulator from 0 to -21°C  
 Plaque eutectique GN 1/1 accumulateur de froid de 0 à -21°C

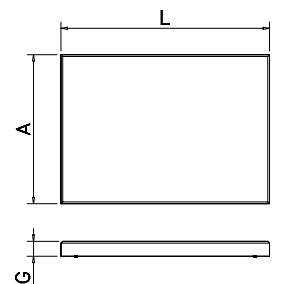

L	A	H	Kg	Barcode	€
530	325	30	5,10	487818	<b>132,00</b>

**Contenedor isotérmico Euronorm 82 L.**  
 Isothermal Euronorm container 82 liters  
 Conteneur isotherme Euronorm 82 L.



L	A	H	Kg	Barcode	€
690	490	370	1,60	487808	<b>120,00</b>

**Forro isotermo interior para cajas de reparto / distribución**  
 Inner isothermal lining for delivery / distribution boxes  
 Doublure intérieure isotherme pour boîtes de livraison / distribution



**N**ovedad  
 ew  
 Nouveauté



L	A	H	Gr	Barcode	€
		300	490	483031	<b>58,50</b>
550	350	380	650	483033	<b>72,50</b>

**Contenedor isotérmico para bebidas con dispensador**  
 Isothermal beverage container with dispenser  
 Récipient à boisson isotherme avec distributeur



**N**ovedad  
 ew  
 Nouveauté

**Características:**

Contenedor isotérmico para bebidas de 10 o 20 litros con dispensador anti-goteo. Fabricado en una sola pieza de polietileno sin uniones, que incorpora una pared doble de aislante de espuma de poliuretano.

Está diseñado para transportarlo de manera sencilla, gracias a las asas ergonómicas ubicadas en la parte superior. Asimismo también facilita su almacenaje y colocación gracias a que pueden apilarse.

Los pestillos de nylon aseguran una apertura y cierre sencillos a la vez que seguros.

**Characteristics:**

Isothermal container for drinks of 10 or 20 liters with anti-drip dispenser. Manufactured from a single piece of seamless polyethylene, incorporating a double wall of polyurethane foam insulation.

It is designed for easy portability, thanks to the ergonomic handles located on the top. It also can be stacked to storage and transport easily. Nylon latches ensure easy and secure opening and closing.

**Caractéristiques:**

Récipient isotherme pour boissons de 10 ou 20 litres avec distributeur anti-goutte. Fabriqué en une seule pièce de polyéthylène sans couture, incorporant une double paroi d'isolation en mousse de polyuréthane.

Il est conçu pour une portabilité facile, grâce aux poignées ergonomiques situées sur le dessus. Il facilite également le stockage et le placement grâce au fait qu'ils peuvent être empilés.

Les loquets en nylon assurent une ouverture et une fermeture faciles et sûres.

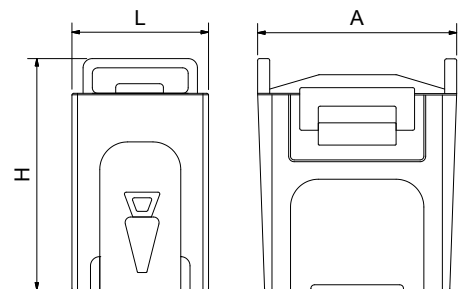

L	A	H	H	Kg	Barcode	€
295	430	500	10	5,95	481030	<b>185,00</b>
295	430	675	20	7,00	481032	<b>230,00</b>



**Cajón liso apilable gris**  
Stackable grey plain box  
Tiroir lisse empilable gris

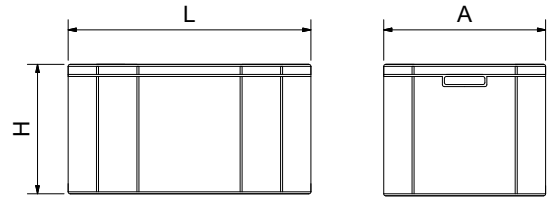

L	A	H		Kg		€
600	400	320	63	2,86	483036	<b>38,00</b>

**Caja apilable multiusos 65 L.**  
Multipurpose stackable box 65 L.  
Boîte gerbable polyvalent 65 L.

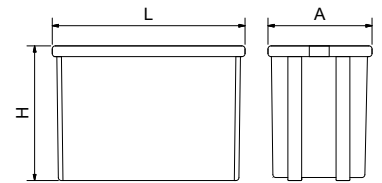

L	A	H		Kg		€
630	440	340	65	2,20	483042	<b>28,00</b>

**Cajón para pescado o marisco con drenaje**  
Box with drain for fish and seafood  
Tiroir pour poisson ou fruits de mer avec drainage

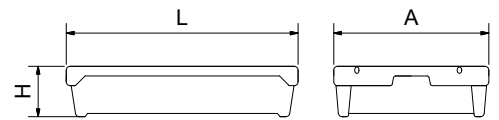

L	A	H		Kg		€
600	400	130	1,20	483038	<b>15,50</b>	



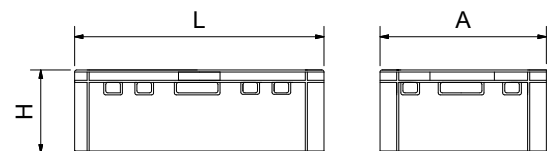

**Cajón liso especial para carne**  
Plain bottom box, especially for meat  
Tiroir lisse spécial viande

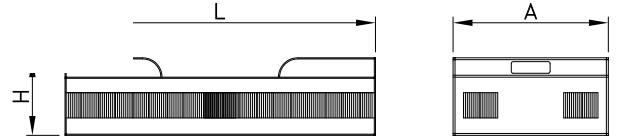

L	A	H		Kg		€
600	400	200	2,00	483040	<b>24,50</b>	

**Cestas alimentarias**  
Food baskets  
Paniers alimentaires



L	A	H		Kg		€
600	400	120		1,15	483008	<b>19,00</b>
600	400	200		1,75	483010	<b>23,00</b>

**Cesta alimentaria ligera**  
Light food basket  
Panier alimentaire légers

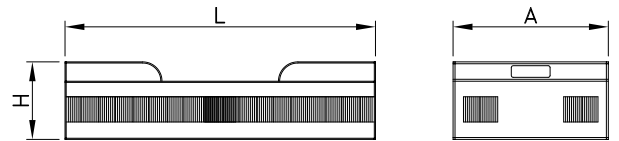

L	A	H	Gr		€
500	300	200	1,15	483012	<b>12,00</b>

**Cesta alimentaria plegable**  
Foldable food basket  
Paniers alimentaires pliables

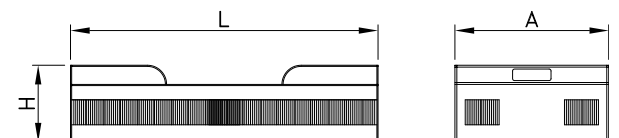
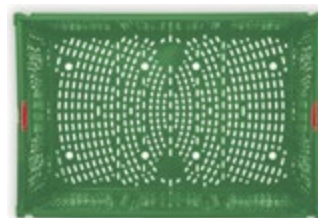
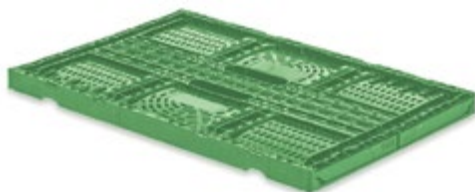

L	A	H	Gr		€
600	400	230	1,82	483014	<b>21,00</b>

### Caja alimentaria apilable

Stackable box for food use  
Boîte alimentaire empilable

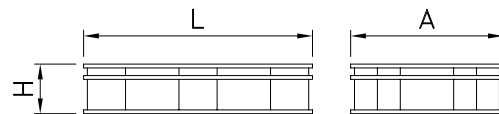

L	A	H	Kg	Barcode	€
400	300	100	0,75	440742	<b>12,00</b>
600	400	100	1,50	440736	<b>15,00</b>
600	400	130	1,65	440738	<b>18,00</b>

### Tapa para caja alimentaria apilable

Lid for stackable food box  
Couvercle pour boîte alimentaire empilable

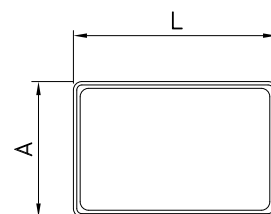

L	A	Gr	Barcode	€
400	300	450	440744	<b>8,00</b>
600	400	900	440740	<b>11,00</b>

### Caja alimentaria apilable perforada para masa

Stackable perforated food box for dough  
Boîte alimentaire perforée empilable pour pâte

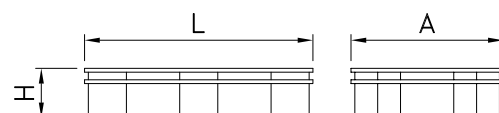

L	A	H	Kg	Barcode	€
600	400	100	1,25	440734	<b>19,00</b>

### Cesta de supermercado sencilla

Simple shopping basket  
Panier supermarché simple

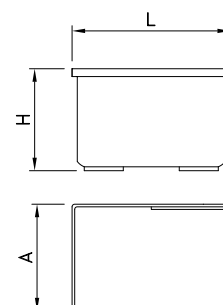

L	A	H	Gr	Barcode	€
430	300	220	600	481052	<b>25,00</b>

### Cesta de la compra supermercado apilable 60 litros con ruedas

Stackable supermarket shopping basket with wheels, 60 liters  
Panier de supermarché empilable 60 litres avec roulettes

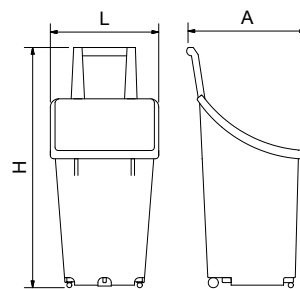

L	A	H	liters	Kg	Barcode	€
400	390	864	60	1,96	481054	<b>45,00</b>

### Elevador inox para cesta de supermercado

Inox shopping trolley, special for supermarket baskets  
Élévateur en acier inoxydable pour panier de supermarché

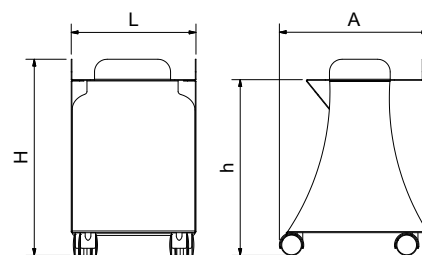

L	A	H	h	Kg	Barcode	€
297	277	467	419	5,60	081050	<b>81,00</b>

### Cesta simple para lavavajillas

Dishwasher simple rack  
Panier

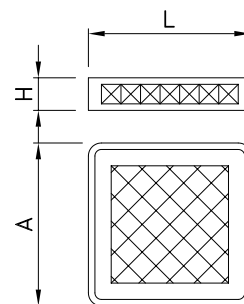

L	A	H	Kg	Barcode	€
400	400	100	1,00	483003	<b>16,00</b>
500	250	100	0,60	483005	<b>11,00</b>
500	500	102	1,22	483004	<b>19,00</b>

### Extensión cesta simple

Rack basket extension  
Extension de panier

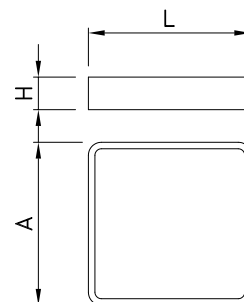

L	A	H	Kg	Barcode	€
500	500	40	0,46	483006	<b>9,00</b>

### Cesta especial platos para lavavajillas

Dishwasher plates rack  
Panier de lave-vaisselle pour assiettes

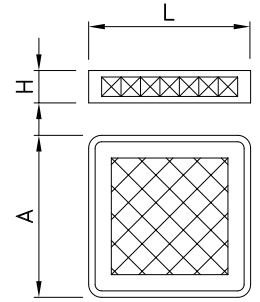

L	A	H	Kg	Barcode	€
500	500	102	1,32	483002	<b>19,00</b>

### Cesta de lavavajillas para bandejas Euronorm o Gastronorm

Dishwasher rack for Euronorm or Gastronorm trays  
Panier lave-vaisselle pour plateau Euronorm ou Gastronorm

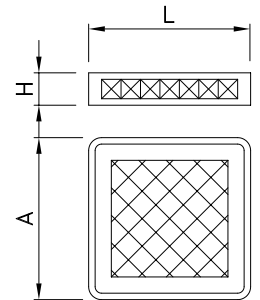

L	A	H	Kg	Barcode	€
500	500	100	1,70	483026	<b>46,00</b>

### Tapa para cestas de lavavajillas

Lid for dishwasher racks  
Couvercle pour panier de lave-vaisselle

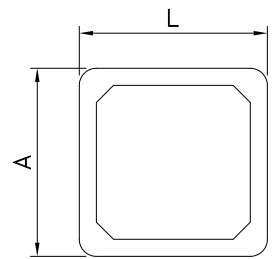

L	A	Gr	Barcode	€
500	500	400	483018	<b>15,00</b>

### Cesta especial vasos para lavavajillas

Dishwasher glasses rack  
Paniers pour verres pour lave-vaisselle

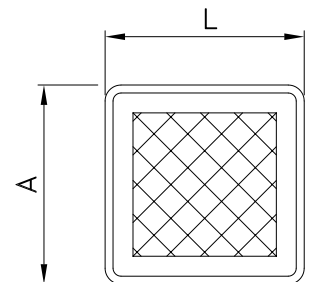

L	A	H	Glasses	Kg	Barcode	€
500	500	102	25	1,55	483020	<b>24,00</b>
			36	1,67	483022	<b>26,00</b>
			49	1,82	483024	<b>28,00</b>

## Cestillo de plástico para cubiertos

Plastic cutlery basket  
Plateau à couverts en plastique

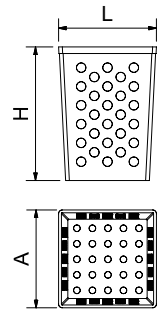

L	A	H	Gr	Barcode	€
110	110	130	100	454860	2,50

## Enjuagador de vasos y jarras a presión para fregadero

Pressure sink washer for glasses and jugs  
Nettoyeur haute pression pour verres et pichets pour évier



**N**ovedad  
CW  
Nouveauté

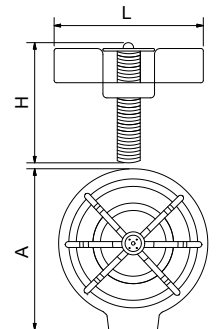

L	A	H	Gr	Barcode	€
150	130	173	200	454280	25,00

## Cepillo lavavasos

Glass washer brush  
Brosse pour lave-verres

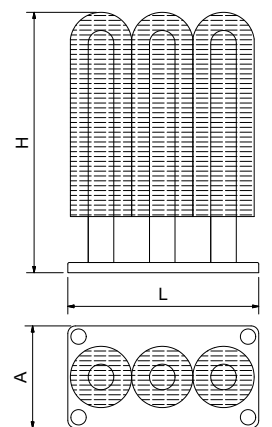

L	A	H	Gr	Barcode	€
190	100	190	390	483062	24,00

## Rollo de 2m de bayeta posavasos antideslizante multiusos

Multipurpose non-slip coaster cloth, 2m roll  
Rouleau de 2 m de tissu anti-dérapant multi-usages



**N**ovedad  
CW  
Nouveauté

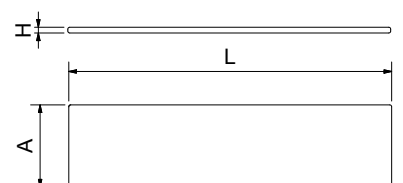

L	A	H	Kg	Barcode	€
2.000	650	1,00	1,00	482050	27,00

**Cubertero**  
Cutlery tray organizer  
Porte-couverts

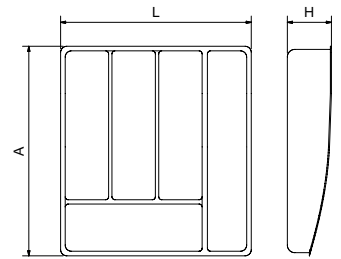

L	A	H	Gr	Barcode	€
245	330	48	450	486206	<b>10,00</b>

**Cubertero plástico gris GN 1/1**  
Cutlery tray organizer GN 1/1  
Range-couverts gris GN 1/1

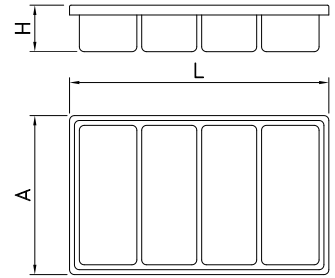

L	A	H	Gr	Barcode	€
530	325	95	500	486208	<b>9,00</b>

**Tapa para cubertero plástico gris GN 1/1**  
Lid for cutlery rack GN 1/1  
Couvercle pour Range-couverts gris GN 1/1

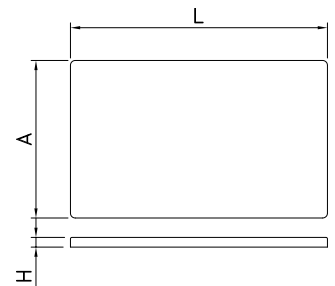

L	A	H	Gr	Barcode	€
530	325	20	400	486210	<b>10,00</b>

**Separador de monedas y billetes**  
Coin and bill tray  
Plateau à monnaie

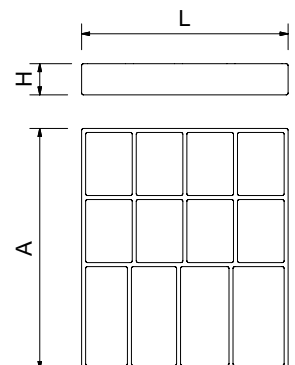

L	A	H	Kg	Barcode	€
311	363	47	0,45	486204	<b>66,00</b>

## Porta-notas mural

Tab grabber  
Porte-notes mural

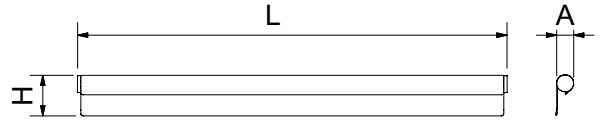

L	A	H	Gr	Barcode	€
508	20	34	400	081802	25,00

## Botelleros

Wine racks  
Porte-bouteilles



Fabricados en acero inoxidable AISI 304, han sido concebidos como complemento de decoración. Con un diseño de líneas sencillas, estos singulares botelleros se adaptarán a infinidad de espacios, sea cual sea su estilo de decoración.

Wholly constructed of stainless steel AISI 304, they have been thought as a complement in decorating. Thanks to its simple design, this outstanding line of wine racks will fit countless ambiances, whatever the style.



Totalement construit en acier inoxydable AISI 304, ils ont été conçus comme un complément en décoration. Grâce à un dessin simple, ce singulier ligne de porte-bouteilles s'adapte à nombreuses ambiances, n'importe quel style décoratif.



L	A	H	D	Gr	Barcode	€
---	---	---	---	----	---------	---

109 100 615 92 800 083048 **44,00**



107 85 615 80 800 083050 **40,00**

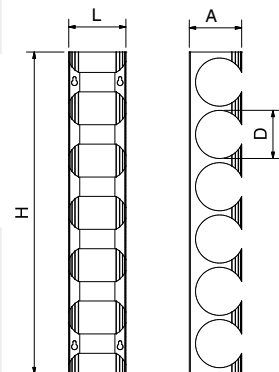

575 120 178 108 1.750 083060 **70,00**

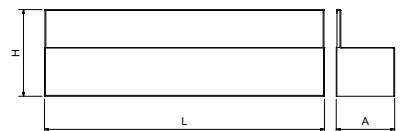



**Cuelga copas**  
Wineglass rack holder  
Accroche-coups



Con tope trasero para evitar la caída de las copas.

With backstop to prevent the falling of the cups.

Avec arrête buttoir pour empêcher la chute des tasses.

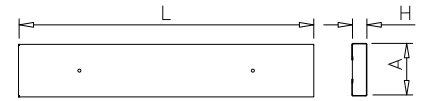

L	A	H	Gr	Barcode	€
470	88	25	575	083002	<b>14,00</b>
970	88	25	1.150	083004	<b>19,00</b>

**Cuelga copas y tazas en varilla**  
Cup and mug rack holder  
Porte tasses et verres à pied en tige inox

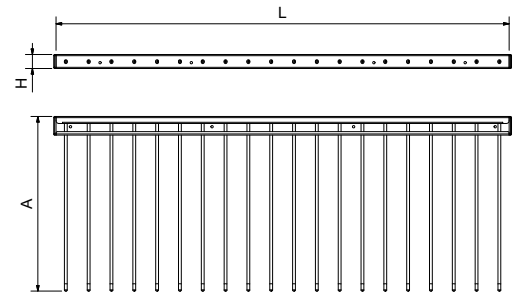
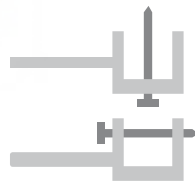

L	A	H	Kg	Barcode	€
973	375	30	3,20	083006	<b>70,00</b>

**Dispensador de vasos**  
Cup dispenser  
Distributeur de verres

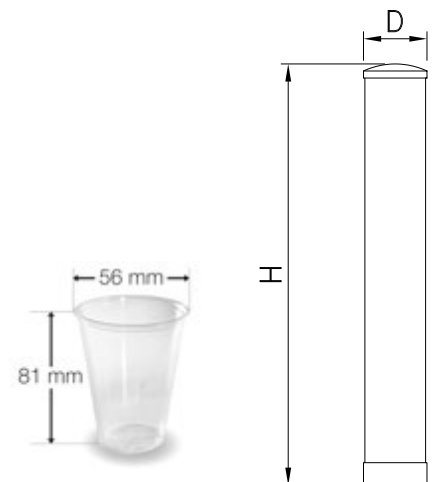

D	H	Gr	Barcode	€
90	597	450	483270	<b>102,00</b>

## Dispensador de vasos universal

Universal cup dispenser  
Distributeur universel de gobelets



Construido totalmente en acero inoxidable, ideal para exteriores e interiores.  
Varillas regulables por lo que es válido para distintos tipos de vasos.  
Diámetro de vaso 30-90 mm.

Totally made in stainless steel. Designed for indoor and outdoor use.  
Adjustable rods to be adapted any cup size.  
Cup diameter: 30-90 mm.

Construit entièrement en acier inoxydable, idéal pour les extérieurs et les intérieurs.  
Tiges réglables donc valable pour différents types de gobelets.  
Diamètre du verre 30-90 mm.

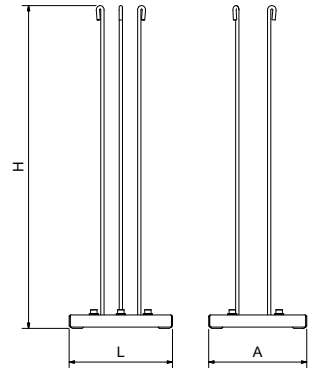

L	A	H	Gr	Barcode	€
158	150	493,5	795	080434	<b>51,00</b>

## Soporte para cafeteras

Stand for coffee pot  
Support pour machine à café

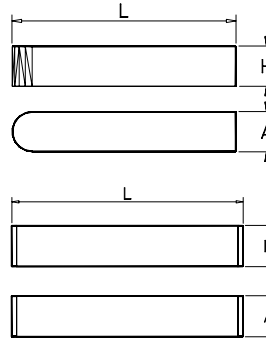

L	A	H	Kg	Barcode	€
---	---	---	----	---------	---

450	80	80	1,3	081202	<b>89,00</b>
-----	----	----	-----	--------	--------------

450	80	80	1,6	081204	<b>40,00</b>
-----	----	----	-----	--------	--------------

## Escalones para vitrinas

Displays stages  
Echelones

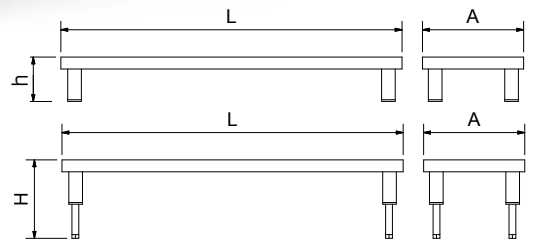
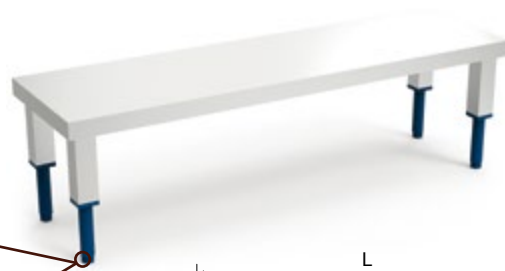

Especialmente concebidos para mejorar la exposición de las carnes y embutidos dentro de los mostradores frigoríficos estándar. Su diversidad de medidas facilitan su adaptación a cualquier modelo de expositor. Construidos en chapa de acero inoxidable que, además de garantizar al máximo su duración, es totalmente higiénico y favorece la distribución del frío. Provistos de pies regulables en altura.

Exclusively designed to improve the display of meat and sausage on the stands of standar fridges. Its diversity of sizes make easier the adaptation at any model of stand. Constructed in stainless steel sheet that guarantees the maximum lenght and furthermore favours the cold distribution.

Spécialement conçus pour améliorer l'exposition des viandes et des charcuteries dans les comptoirs frigorifiques standard. Sa diversité de dimensions facilitent sa adaptation a quelque modèle de comptoir. Construit en plaque d'acier inoxydable, lequel en plus de garantir au maximum sa durée, est totalement hygiénique et favorise la distribution du froid. Pourvu de pieds réglables en hauteur.

L	A	h	H	Kg	Barcode	€
800	300	130	230	2,8	082002	<b>148,00</b>
1.000	300	130	230	3,4	082004	<b>154,00</b>
1.200	300	130	230	3,9	082006	<b>160,00</b>
1.400	300	130	230	4,4	082008	<b>175,00</b>
600	400	130	230	2,8	082018	<b>114,00</b>
800	400	130	230	3,4	082010	<b>160,00</b>
1.000	400	130	230	4,0	082012	<b>171,00</b>
1.200	400	130	230	4,7	082014	<b>175,00</b>
1.400	400	130	230	5,4	082016	<b>196,00</b>

## Soporte sobre-mostrador para balanzas

Stand support for scales  
Support sur comptoir pour balances



### Características:

Específicamente diseñados para colocar las balanzas, cortadoras de fiambre y demás maquinaria encima del mostrador.

Sus topes regulables permiten adaptarse a cualquier ancho de la tapa del mostrador.

Gran firmeza. Fácilmente montable y desmontable.

### Characteristics:

Specifically designed for placing scales, sausage cutting and other machines on the stand.

Its width adjustable butts allow it to adjust to any width of the stand top.

Great firmness. Easy assembly and unassembly.

### Caractéristiques:

Especialément desinés pour placer balances, coupe charcuteries et autres machines sur le comptoir.

Ses butoirs réglables en largeur le permettent s'adapter a quelque largeur du couverture sur le comptoir.

Gran solidité. Facilité por le monter et démonter.

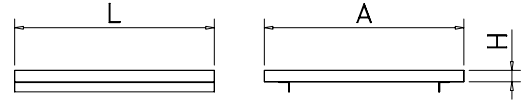

L	A	H	Kg	Barcode	€
390	390	30	3,3	082202	85,00

## Tolva evacuación de desperdicios para adosar a tajos de troceo

Waste receptacle for scraps to fix to chopping blocks  
Trémie d'évacuation des déchets pour adosser à billots



Válida para ser acoplada en los siguientes modelos de tajos:

Tajos de troceo lastrados.  
Tajos de troceo de fibra con faldón.

Valid to be assembled in the following models of chopping blocks:  
Reinforced and weighted.  
Fibre chopping blocks with fringe.

Valide pour être couplé dans les suivantes modèles d'hachoirs a viande:  
Hachoirs à viande blindés.  
Hachoirs à viande en fibre avec support à pan.

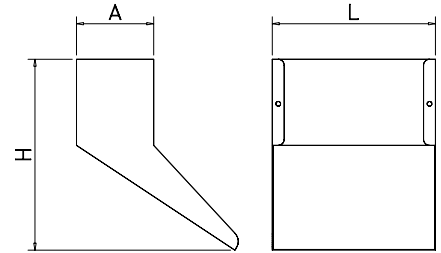

L	A	H	Kg	Barcode	€
275	130	324	2,3	082402	66,00

## Pala para hielo

Ice spade  
Pelle à glaçons



### Características:

Su fabricación en polipropileno garantiza:

No absorbe agua.

No pierde su dureza en condiciones de humedad.

Puede ser esterilizado (no en autoclave).

Soporta temperaturas de hasta 100°C.

### Characteristics:

It is made of polypropylene, which guarantees:

No water absorption.

No loss of hardness in humidity conditions.

Possibility of sterilization.

It resists temperatures up to 100°C.

### Caractéristiques:

Sa fabrication en polypropylène garantit:

Pas d'absorption d'eau.

Pas de perte de dureté dans conditions d'humidité.

Possibilité de stérilisation.

Supporte température jusqu'à 100°C.

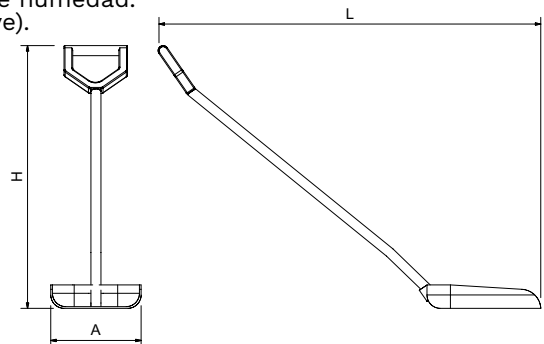

L	A	H	Kg	Barcode	€
1.107	279	890	1,5	474458	93,00

## Pala de mano para hielo

Ice shovel  
Pelle à glaçons



**Characteristics:**  
It is made of polypropylene, which guarantees:  
No water absorption.  
No loss of hardness in humidity conditions.  
Possibility of sterilization.  
It resists temperatures up to 100°C.

**Caractéristiques:**  
Sa fabrication en polypropylène garantit:  
Pas d'absorption d'eau.  
Pas de perte de dureté dans conditions d'humidité.  
Possibilité de stérilisation.  
Supporte température jusqu'à 100°C.

### Características:

Su fabricación en polipropileno garantiza:  
No absorbe agua.  
No pierde su dureza en condiciones de humedad.  
Puede ser esterilizado (no en autoclave).  
Soporta temperaturas de hasta 100°C.

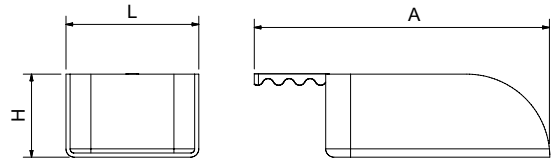

L	A	H	Gr	474456	€
160	340	90	150	474456	12,00

## Recubrimiento modular para islas de congelación

Modular lid for island site freezers  
Dessus vitré pour congélateurs libre-service

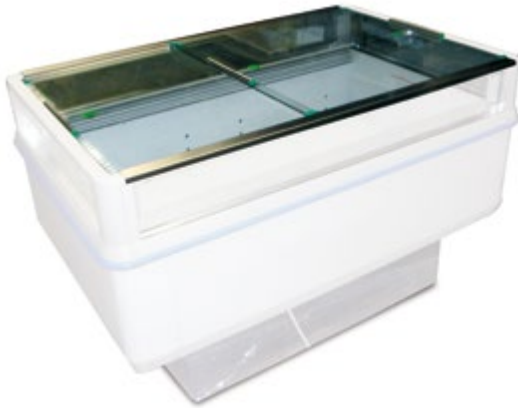

### Características:

Sistema modular de cubiertas de vidrio o plástico, diseñado para actualizar las islas de congelados antiguas a las necesidades actuales de ahorro de energía.  
Este sistema reduce la transferencia térmica en un 80%.  
Perfilería de acero inoxidable.  
Fácil de instalar.

### Characteristics:

Modular system of glass or plastic lids designed to adapt the old frozen islands to the current needs of energy saving.  
This system reduces the heat transfer by 80%.  
Sections in stainless steel.  
Easy to install.

**Caractéristiques:**  
Système modulaire de dessus vitrés ou en plastique conçus pour adapter les congélateurs libre-service vieux aux besoins actuels d'économie énergétique.  
Ce système réduit le transfert thermique le 80%.  
Profils en acier inoxydable.  
Facile à installer.

	max.		€	M. lineal linear meter mètre linéaire
Plástico Plastic Plastique	1.000	083850	294,00	
Cristal Glass Verre	1.000	083802	415,00	

## Cubre aperitivos BC

BC appetizers screen  
Vitrine à tapas BC

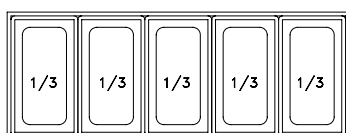
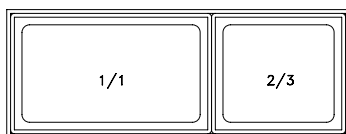

L	A	H	Kg	083604	€
1.000	125	135	2,00	083604	79,00

## Vitrina cubre aperitivos

Counter top display  
Vitrine à tapas

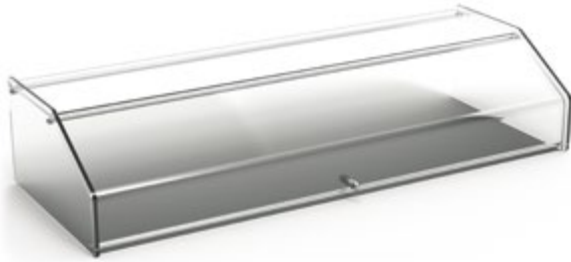

### Características:

Capacidad de la vitrina: 5 cubetas GN 1/3 de 325x176 mm

### Characteristics:

Display capacity: 5 containers GN 1/3 (325x176 mm)

### Caractéristiques:

Capacité de la vitrine: 5 bacs GN 1/3 (325X176 mm)



Cubetas GN no incluidas.  
GN containers not included.  
Bac GN non inclus.

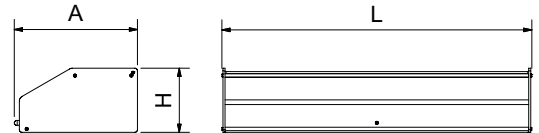
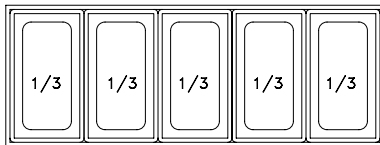
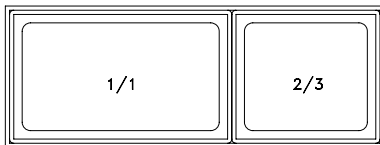

L	A	H	Kg	Barcode	€
918,5	365	190	4,50	083602	170,00

## Cubierta basculante para cubetas Gastronorm 1/1

Dome cover for Gastronorm container 1/1  
Couverture basculement pour bac gastro 1/1

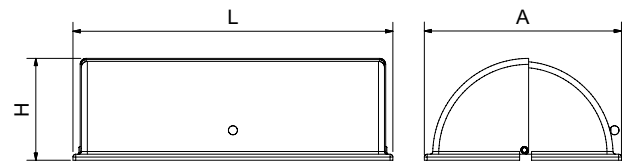

L	A	H	Kg	Barcode	€
530	325	175	1,5	487230	77,00

## Vitrina bollería

Bakery display case  
Vitrine viennoiserie

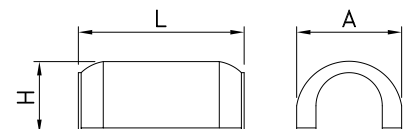

L	A	H	Kg	Barcode	€
450	300	180	1,00	440320	42,00

### Vitrina bollería doble piso

Bakery display case - 2 displaying shelves  
Vitrine viennoiserie double étage

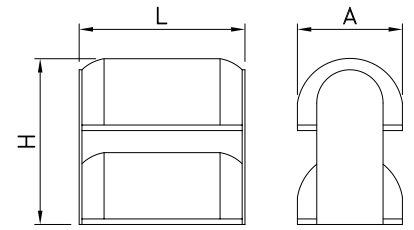

L	A	H	Gr	Barcode	€
300	190	320	800	440318	<b>45,00</b>
400	300	460	1260	440322	<b>106,00</b>

### Gaveta expositora

Pick and mix bin  
Casier de rangement

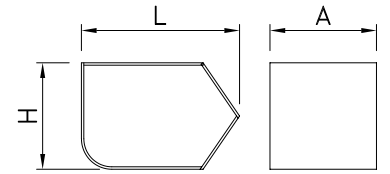

L	A	H	Gr	Barcode	€
260	175	175	600	483610	<b>29,00</b>

### Queseras base plástico

Cheese keepers with plastic tray  
Cloches à fromage base en plastique



Color al azar.  
Random colour.  
Colorido aleatoriamente.

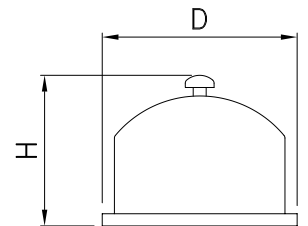

D	H	Gr	Barcode	€
245	175	450	480612	<b>9,00</b>

### Pizarra de led con atril

LED blackboard with easel  
Chevalet ardoise lumineuse LED



Rotuladores de tiza borrrable no incluido.

Not included erasable chalk marker.

Marquer craie effaçable non inclus.

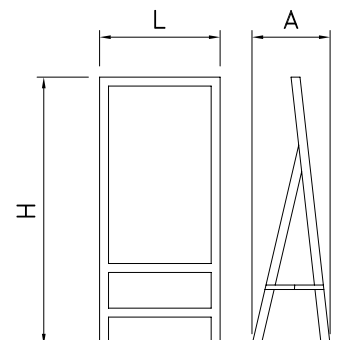

L	A	H	Kg	Barcode	€
540	350	1.200	2,40	480238	<b>75,00</b>

### Cesta expositora de rejilla rectangular

Rectangular mesh display basket  
Panier présentoir grillagé rectangulaire

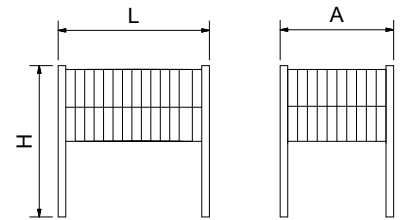

L	A	H	Kg	Barcode	€
800	600	800	6,3	475620	<b>83,00</b>

### Cesta expositora de rejilla circular 3 niveles

3 level circular mesh display basket  
Panier de présentation grillagé circulaire à 3 niveaux

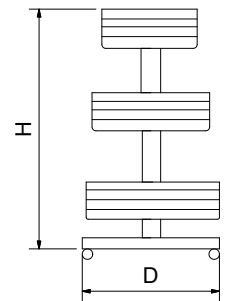

D	H	Kg	Barcode	€
700	1.280	9,0	475630	<b>179,00</b>

### Portaprecios en varilla inox con pincho

Stainless steel price-holder rod with spike  
Porte-prix en tige inox avec broche

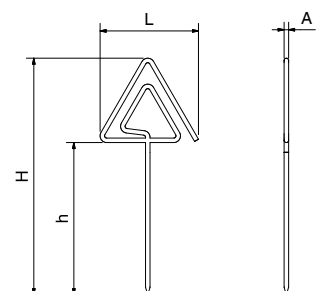

L	A	H	h	Gr	Barcode	€
60	6	160	100	25	081850	<b>4,00</b>

## Portaprecios en varilla inox

Stainless steel price-holder rod  
Porte-prix en tige inox

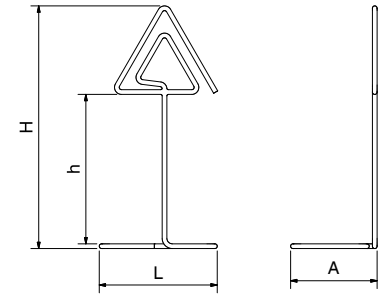

L	A	H	h	Gr	Barcode	€
75	55	165	95	35	081860	<b>8,00</b>

## Envasadora al vacío

Vacuum packaging machine  
Machine d'emballage sous vide



Motor de alta calidad.  
120 W.  
800 mbar.  
Ancho máximo de bolsa 320 mm.  
Interruptor con doble protección.  
Bandeja de goteo extraíble.  
Cutter integrado.  
Silenciosa.

Su potente motor de 120 W y 800 mbar de presión, realiza el vacío sin esfuerzo creando un sello hermético que conserva la frescura y prolonga la vida útil de los alimentos.

Ya sea un cocinero doméstico o un chef profesional, nuestra envasadora al vacío es el complemento indispensable para su cocina, destacando su potencia, eficacia, sencillez de uso y de limpieza.

High-quality motor.  
120 W.  
800 mbar.  
Maximum bag width 320 mm.  
Double protection switch.  
Removable drip tray.  
Integrated cutter.  
Silent.

Its powerful 120W motor and 800 mbar pressure vacuum seals effortlessly, while creating an airtight seal that preserves freshness and extends the shelf life of food.

Whether you're a home cook or a professional chef, our vacuum sealer is a key accessory to your kitchen, boasting power, efficiency, ease of use, and cleaning.

Moteur de haute qualité.  
120 W.  
800 mbar.  
Largeur maximale du sac 320 mm.  
Interrupteur avec double protection.  
Plateau d'égouttage amovible.  
Cutter intégré.  
Silencieux.

Son moteur puissant de 120W et sa pression de 800 mbar réalisent la mise sous vide sans effort, créant une étanchéité hermétique qui préserve la fraîcheur et prolonge la durée de conservation des aliments.

Que vous soyez un cuisinier amateur ou un chef professionnel, notre machine sous vide est un complément indispensable à votre cuisine, offrant puissance, efficacité, facilité d'utilisation et de nettoyage.



L	H	Gr	Kg	Barcode	€
200	300	100	1,01	480292	<b>39,00</b>
250	350	100	1,07	480294	<b>57,00</b>
300	400	100	1,39	480296	<b>84,00</b>

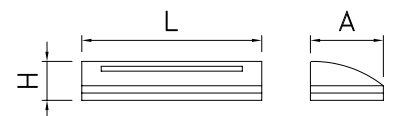

L	A	H	Potencia Power Puissance	Tensión Voltage Tension	Frecuencia Frequency Fréquence	Largo de sellado Sealing length Longueur de scellage	Máxima depresión Max depression Max dépression	Succión l/min. Double pump suction Suction de la pompe double	Kg	Barcode	€
400	170	115	120 W	220-240 V	50 Hz.	320	800 mbar	13 lt/min.	2,20	480288	<b>105,00</b>



## Envolvedora de sobremesa

Desktop wrapping machine  
Machine à envelopper de bureau



Machine d'emballage sur table pour film étirable  
Découpage de film par résistance de coupe rétractable.  
Plaque d'étanchéité antiadhésive avec contrôle automatique de la température.  
Clignotants de l'état de la résistance à la coupure, l'étanchéité et le fonctionnement général de l'appareil.  
Protection contre les charges électrostatiques.  
Construction solide: tôle d'acier inoxydable et en aluminium anodisé.

APPLICATIONS:  
Largement utilisé pour l'emballage des produits directement sur des plateaux en carton, polyéthylène, PVC rigide, etc.  
MAXIMUM LARGEUR DU FILM 450 MM.

Máquina de envolver de sobremesa para film estirable.  
Corte de film por resistencia escamoteable.  
Plancha de sellado antiadherente con regulación automática de temperatura.  
Indicadores luminosos del estado de la resistencia de corte, sellado y funcionamiento general de la máquina.  
Protección contra cargas estáticas.  
Sólida fabricación: chapa de acero inoxidable y aluminio anodizado.

APLICACIONES: Aplicable para envolver directamente los productos sobre bandejas de cartón, polietileno, PVC rígido, etc.

FILM UTILIZABLE:  
Bobina de film extensible de 450 mm.

Worktop wrapping machine for stretch film.  
Film cut by retractable cutter resistance.  
Nonstick sealing hotplate with automatic temperature control.  
Indicator lights for the status of the cutting resistance, the sealing and the general operation of the device.  
Protection against electrostatic charges.  
Solid construction: Stainless steel sheet and anodized aluminum.

APPLICATIONS: Extensively used for packing products directly on consumable trays in carton, polyethylene, rigid PVC, etc.  
MAXIMUM FILM: Width 450mm.

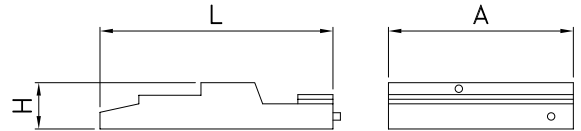

L	A	H	Potencia Power Puissance	Tensión Voltage Tension	Frecuencia Frequency Fréquence	Kg	Barcode	€
600	500	180	300 W	220-240 V	50-60 Hz.	3,5	480270	250,00

## Cierra bolsas inox

Stainless steel bag closer  
Scelleuse des sachets en acier inoxydable



Para cinta de 12 mm.

For packing tape 12mm.

Pour du ruban d'emballage 12mm.

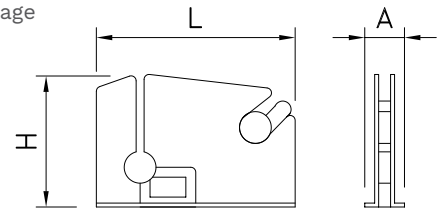

L	A	H	Gr	Barcode	€
220	75	150	350	480274	27,00

## Parking para mascotas en acero inoxidable

Pets parking in stainless steel  
Parking pour animaux de compagnie en acier inoxydable

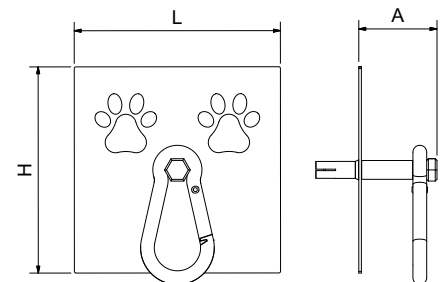

L	A	H	Kg	Barcode	€
120	45,50	120	0,26	082670	22,00
240			0,51	082672	34,00

**Máquina termoselladora para bolsas de 400 mm.**  
Heat sealer for bags of 400 mm.  
Machine à sceller pour sacs de 400 mm.

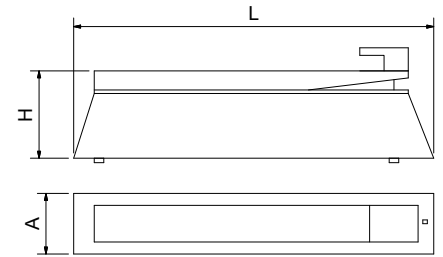

L	A	H	Potencia Power Puissance	Frecuencia Frequency Fréquence	Tensión Voltage Tension	Kg	Barcode	€
560	95	170	470 W	50/60 Hz	220 V	2,90	480298	<b>137,00</b>

**Parking soporte para aparcamiento de bicicletas en acero inoxidable**  
Bike parking stand in stainless steel  
Parking à vélos en acier inoxydable

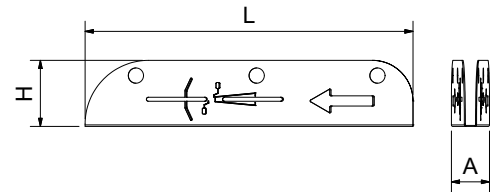

L	A	H	Kg	Barcode	€
645	69	130	2,75	084610	<b>54,00</b>

**Paragüero inox**  
Umbrella stand  
Porte-parapluies

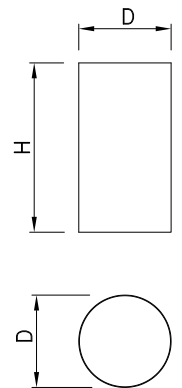

D	H	Kg	Barcode	€
300	550	3,4	481440	<b>91,00</b>

**Soporte dispensador de bolsas de paraguas**  
Umbrella bag dispenser column support  
Support distributeur de sacs pour parapluie

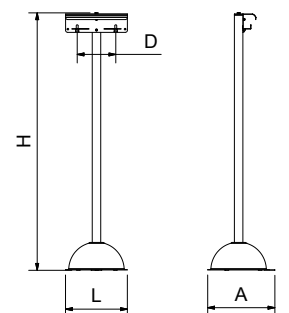

464648 15,00 200  
Bolsas de paraguas para dispensador - 200 ud.  
Umbrella bags for dispenser - 200 pc  
Sacs pour parapluie pour distributeur - 200 pc

L	A	H	D	Gr	Barcode	€
290	315	1.208	90-215	350	064650	<b>122,00</b>

## Perchero

Clothes stand  
Portemanteau

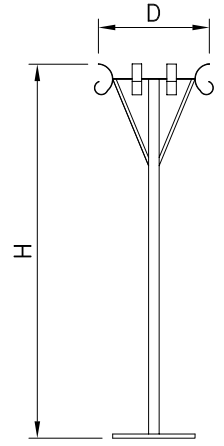

D	H	Kg	Barcode	€
390	1.700	8,0	481444	249,00

## Perchero mural de acero inoxidable

Stainless steel wall-mounted coat peg  
Portemanteau mural en acier inoxydable

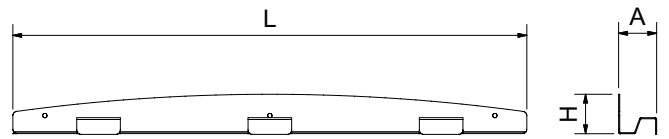

L	A	H	Kg	Barcode	€
708	55	55	0,9	081460	25,00

## Percha industrial de acero inoxidable

Stainless steel industrial hanger  
Cintre industrielle en acier inoxydable



### Características:

Totalmente construida en acero inoxidable.  
Soldadura de alta resistencia.  
Ideal para gimnasios, piscinas, vestuarios colectivos, lavanderías, etc.  
Diseño renovado que permite colgar delantales y prendas con tirantes.

Characteristics:  
Wholly made in stainless steel.  
High resistance welding.  
Excellent for gymnasiums, swimming pools, dressing-rooms, laundries, etc.  
New design that allows to hang up aprons and garments with shoulder straps.

Caractéristiques:  
Entièrement construit en acier inoxydable.  
Soudure en haute résistance.  
Excellente pour gymnases, piscines, établissements de bains, blanchisseries, etc.  
Dessin renouvelé qui permet prendre des tabliers et vêtements à épaulettes.

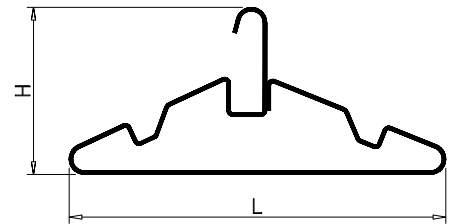

L	H	Gr	Barcode	€
420	190	120	081450	11,00

## Set colgador sujeta-palos

Handle-holder kit  
Kit porte-manches







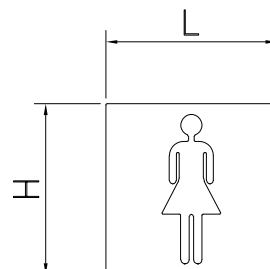



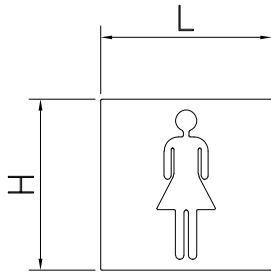







L	A	H	Gr	Barcode	€
275	40	50	320	481208	24,00

**Pictogramas en acero inoxidable**  
Stainless steel pictograms  
Pictogrammes en acier inoxydable











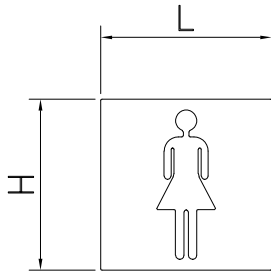





	L	H	Gr	Barcode	€	
	Aseo Mujer Women restroom Toilette femme	120	120	175	082604	<b>9,00</b>
	Aseo Hombre Men restroom Toilette homme	120	120	175	082602	<b>9,00</b>
	Aseo familiar Family toilet Toilette familial	120	120	175	082618	<b>9,00</b>
	Cambia-Bebes Baby changing room Chambre bébés	120	120	175	082616	<b>9,00</b>
	Tercera edad Senior people Personnes âgées	120	120	150	082666	<b>9,00</b>
	Aseo unisex Unisex toilet Toilette unisexe	120	120	175	082634	<b>9,00</b>
	Aseo Discapitados Disabled restroom Toilette handicapés	120	120	175	082614	<b>9,00</b>
	Ascensor Lift Ascenseur	120	120	139	082668	<b>9,00</b>
	Vestuario/Guardarropa Dressing room or cloakroom Vestiaire ou garde-robe	120	120	175	082620	<b>9,00</b>
	Duchas Shower Douche	120	120	175	082636	<b>9,00</b>
	Botiquín First aid box Boîte de secours	120	120	175	082628	<b>9,00</b>



	L	H	Gr	Barcode	€
 <b>Restaurante</b> Restaurant Restaurant	120	120	175	082630	<b>9,00</b>
 <b>Información</b> Information desk Point d'information	120	120	175	082626	<b>9,00</b>
 <b>Dirección</b> Direction Direction	120	120	175	082612	<b>9,00</b>
 <b>Permitido fumar</b> Smoking allowed Permet de fumer	120	120	175	082608	<b>9,00</b>
 <b>Prohibido fumar</b> No smoking Défense de fumer	120	120	175	082606	<b>9,00</b>
 <b>Prohibido</b> No trespassing Interdit	120	120	175	082610	<b>9,00</b>
 <b>Prohibido el paso</b> No trespassing Passage interdit	120	120	175	082622	<b>9,00</b>
 <b>Prohibido animales</b> No Animals Animaux interdit	120	120	175	082624	<b>9,00</b>
 <b>Prohibido el uso de teléfono</b> No mobile phone Portable interdit	120	120	175	082632	<b>9,00</b>
 <b>Zona Wifi</b> Wifi zone Wifi Zone	120	120	175	082638	<b>9,00</b>
 <b>Cafetería</b> Coffee shop Cafétéria	120	120	175	082640	<b>9,00</b>
 <b>Parking</b> Parking Parking	120	120	175	082642	<b>9,00</b>
 <b>Carros</b> Shopping carts Caddies	120	120	175	082644	<b>9,00</b>
 <b>WC</b> WC WC	120	120	175	082664	<b>9,00</b>
 <b>Uso obligatorio de mascarilla</b> Mandatory mask Utilisation obligatoire du masque	120	120	133	082678	<b>9,00</b>
 <b>Mascarilla</b> Mask Masque	120	120	141	082680	<b>9,00</b>





	L	H	Gr	Barcode	€
 <b>Guantes</b> Gloves Gants	120	120	145	082682	<b>9,00</b>
 <b>Puesto de gel hidroalcohólico</b> Hydroalcoholic gel station Station de gel hydroalcoolique	120	120	148	082684	<b>9,00</b>
 <b>Termómetro</b> Thermometer Thermomètre	120	120	147	082686	<b>9,00</b>
 <b>Desinfección de calzado</b> Shoes disinfection Désinfection des chaussures	120	120	140	082688	<b>9,00</b>
 <b>Espere tras la línea</b> Do not cross the line Attendez derrière la file	120	120	126	082690	<b>9,00</b>
 <b>Distancia de seguridad</b> Safety distance Distance de sécurité	120	120	123	082692	<b>9,00</b>
 <b>Número 0</b> Number 0 Numéro 0	60	120	70	082646	<b>9,00</b>
 <b>Número 1</b> Number 1 Numéro 1	60	120	70	082648	<b>9,00</b>
 <b>Número 2</b> Number 2 Numéro 2	60	120	70	082650	<b>9,00</b>
 <b>Número 3</b> Number 3 Numéro 3	60	120	70	082652	<b>9,00</b>
 <b>Número 4</b> Number 4 Numéro 4	60	120	70	082654	<b>9,00</b>
 <b>Número 5</b> Number 5 Numéro 5	60	120	70	082656	<b>9,00</b>
 <b>Número 6</b> Number 6 Numéro 6	60	120	70	082658	<b>9,00</b>
 <b>Número 7</b> Number 7 Numéro 7	60	120	70	082660	<b>9,00</b>
 <b>Número 8</b> Number 8 Numéro 8	60	120	70	082662	<b>9,00</b>
 <b>Número 9</b> Number 9 Numéro 9	60	120	70	082658	<b>9,00</b>

## Columna señalización con cinta

Belt barrier post  
Colonne de signalisation avec bande

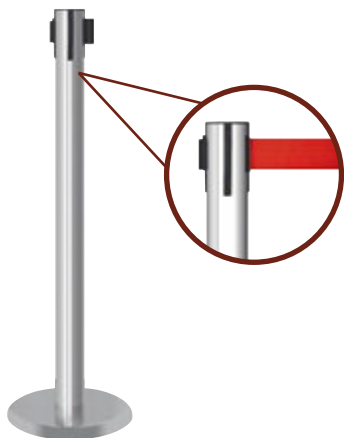

**Características:**  
Acero inoxidable AISI201  
Cinta de 1,8 metros.

**Characteristics:**  
Stainless Steel AISI201  
1,8 meter ribbon.

**Caractéristiques:**  
Acier inoxydable AISI201  
Ruban de 1,8 mètres.

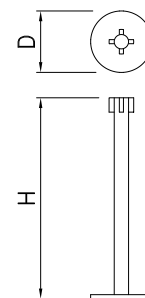

D	H	Kg	Barcode	€
320	910	5,5	481446	<b>55,00</b>

## Cinta mural extensible de señalización

Extendable wall tape for signaling  
Ruban mural extensible de signalisation



**Características:**  
Cinta de 2 metros.

**Characteristics:**  
2 meter ribbon.

**Caractéristiques:**  
Ruban de 2 mètres.

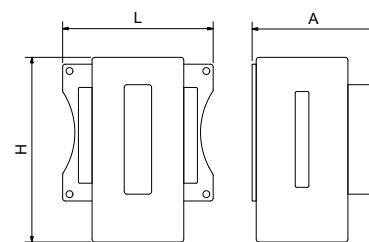

L	A	H	Kg	Barcode	€
110	90	135	0,38	481448	<b>37,00</b>

## Visor su turno con mando

Queuing ticket screen with remote controlled  
Écran pour file d'attente avec commandé



480850 65,00

**Mando inalámbrico de repuesto**  
Replacement wireless control  
Commande sans fil de remplacement



L	A	H	Potencia Power Puissance	Tensión Voltage Tension	Frecuencia Frequency Fréquence	Kg	Barcode	€
275	55	240	6 W	220-240 V	50-60 Hz.	4,50	480811	<b>275,00</b>

## Dispensador de tickets su turno

Queuing ticket dispenser  
Distributeur de tickets file d'attente



480809 4,00

**Rollo 2.000 tickets su-turno**  
Roll of 2000 queue tickets "My turn"  
Rouleau de 2000 tickets pour file d'attente

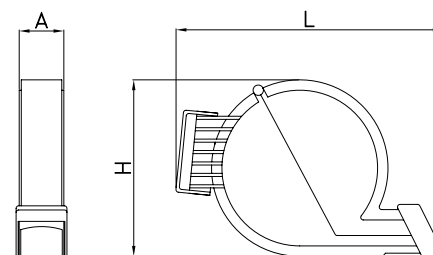
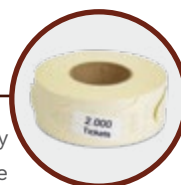

L	A	H	Kg	Barcode	€
265	45	175	0,32	480810	<b>21,00</b>

**Columna de acero inoxidable para dispensadores**  
 Stainless-steel stand for dispensers  
 Stand en acier inoxydable pour distributeurs

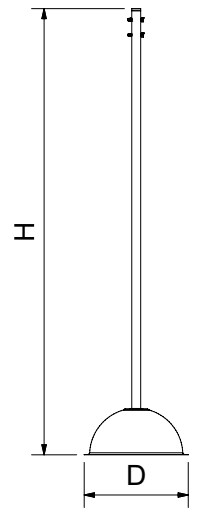
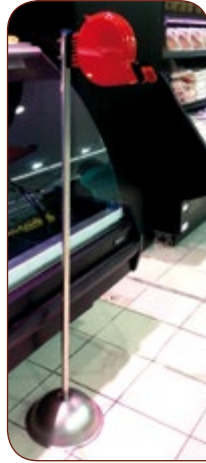

D	H	Kg	080430	€
290	1.245	9,00	080430	118,00

**Columna inoxidable con dispensador "Su turno"**  
 Stainless floor stand for queuing ticket dispenser  
 Pied inoxydable avec distributeur "votre Tour"

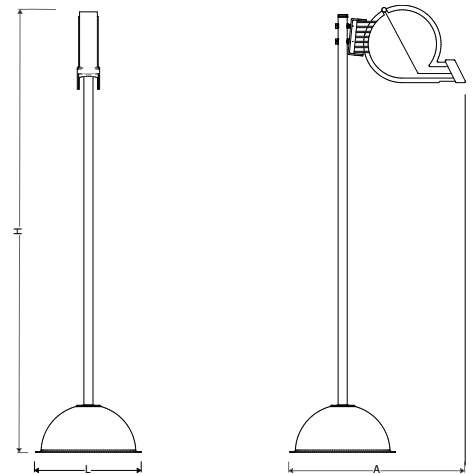

L	A	H	Kg	080432	€
290	422	1.245	9,32	080432	155,00

**Equilibrador**  
 Spring balancer  
 Equilibrateur



**Características:**  
 Equilibrador para uso intermitente.  
 Capacidad regulable y dispositivo de limitación de carrera.  
 Cuerpo de chapa metálica.  
 Longitud del cable: 1000 mm.  
 Capacidad de 0,5 - 1,5 kilos.

**Characteristics:**  
 Spring balancer for uncontinuous use.  
 Adjustable capacity with stroke limitation device.  
 Metallic sheet body.  
 Cable length: 1000 mm.  
 Capacity from 0,5 - 1,5 kg

**Caractéristiques:**  
 Equilibrateur pour usage intermittent.  
 Capacité réglable et dispositif de limitation de vitesse.  
 Boîtier en tôle métallique.  
 Longueur du câble :1000 mm  
 Capacité de 0,5-1,5 Kg

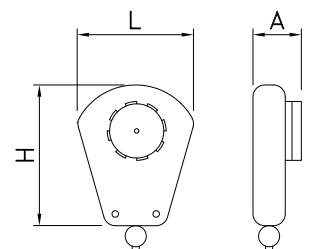
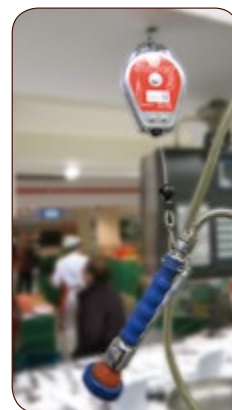

L	A	H	Gr	463030	€
100	55	120	500	463030	70,00



## Taburete inox regulable en altura

Adjustable stainless steel stool

Tabouret inox réglable

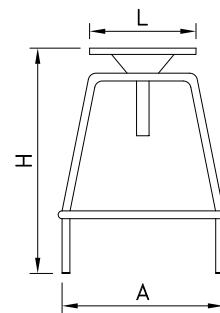

L	A	H	H <sub>int</sub>	Kg	Barcode	€
350	550	850	600	4,8	482206	<b>252,00</b>

## Escalones inox

Inox stairs

Marche inox

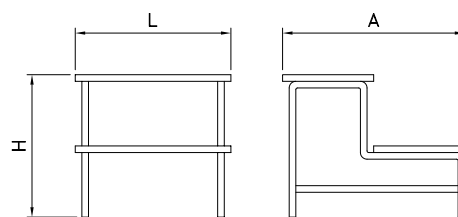

L	A	H	Kg	Barcode	€
470	550	430	1,50	482208	<b>180,00</b>

## Taburete rodante profesional en acero inoxidable

Sloping wall rack shelf

Étagère murale inclinée pour paniers de lavage

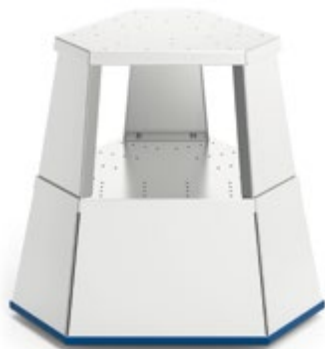

### Características:

Construido totalmente en acero inoxidable, este taburete profesional móvil de 2 peldaños garantiza a los usuarios una superficie robusta, estable y segura donde alzarse.

Dispone de 3 ruedas retráctiles para un cómodo desplazamiento mientras no está en uso, mientras que cuando el usuario lo utiliza, éste se adhiere al suelo con firmeza para evitar movimientos no deseados.

Gracias a estar fabricado en acero inoxidable, a diferencia de los taburetes del mercado, nuestro taburete es ideal para su utilización en ambientes hostiles, como industria alimentaria en general, industria cárnica, salas frías, salas de despiece, obradores, laboratorios... En resumen, cualquier estancia que precise una higiene rigurosa ya que es fácil de limpiar y desinfectar, incluso con hidrolimpiadora.

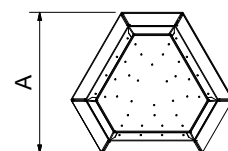
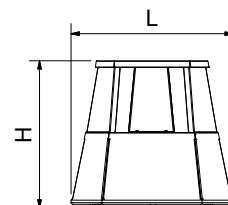

L	A	H	Kg	Barcode	€
479	416	435	5,50	082220	<b>220,00</b>

### Characteristics:

This professional two steps stainless steel kick stool guarantees to users a robust, stable and safe surface to step onto.

It is supplied with three retractable wheels for easy moving while not in use, whereas it adheres firmly to the ground to prevent unwanted movements when in use.

Made in of stainless steel and thus especially recommended for general food industry (meat industry, cold rooms, laboratories...) or elsewhere with strict hygiene is required, by contrast to most of the step stools on the market.

### Caractéristiques:

Fabriqué en acier inoxydable, ce tabouret professionnel mobile à 2 marches garantit aux utilisateurs une surface robuste, stable et sûre où monter.

Il dispose de 3 roues rétractables pour un déplacement confortable lorsqu'il n'est pas utilisé, tandis que lorsque on l'utilise, il adhère fermement au sol pour éviter tout mouvement indésirable.

Grâce à sa fabrication en acier inoxydable, contrairement à d'autres modèles sur le marché, notre tabouret est idéal pour une utilisation dans l'industrie alimentaire en général, industrie de la viande, chambres froides, laboratoires... Bref, toute pièce nécessitant une hygiène rigoureuse.

**Taburete con ruedas**  
Rolling step-stool  
Tabouret marche - pied roulant



482250 5,80

Rueda de repuesto para taburetes.  
Spare wheel for step-stools.  
Rouelle de rechange pour tabouretes.

**Características:**

Este taburete metálico lleva en su base tres ruedas que permiten su fácil traslado de un sitio a otro con un simple empujón del pie, sin embargo en el momento en que usted sube sobre él queda totalmente fijado al suelo gracias a su burlete circular que se adhiere como una ventosa.

**Characteristics:**

This metallic stool has on its base three castors that allow moving it from one place to another easily, just pushing it with your foot. Furthermore, whenever you are standing on it, it is firmly fixed to the floor, as if it were a suction pad, thanks to its rounded rubber strip.

**Caractéristiques:**

Ce tabouret métallique a dans sa base trois rouelles qui permettent le déplacer facilement de long en large, avec un seul poussé du pied. En plus, lorsqu'on monte sur lui, il reste totalement fixé au sol, comme une ventouse, grâce à sa bande ronde en caoutchouc.

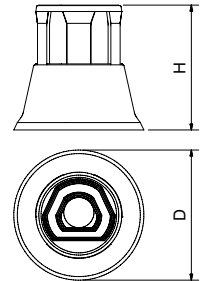

D	H	Kg		€
			482202	
430	430	4,6	482204	69,00
			482212	

**Losetas antideslizantes**  
Non-slip floor tiles  
Caillebotis anti-dérapant

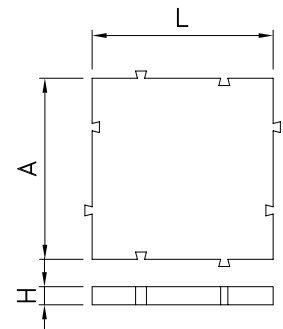

L	A	H	Kg	€
500	500	25	1,10	481040 16,00
500	500	50	1,73	481042 24,00
1.000	500	50	3,35	481044 51,00

**Rampa loseta**  
Floor slat ramp  
Rampe pour caillebotis

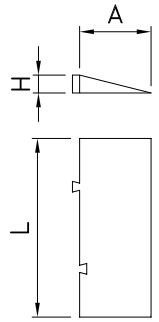
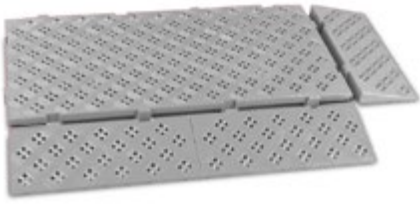

L	A	H	Gr	Barcode	€
500	200	50	565	481046	<b>24,00</b>

**Palet encajable enrejado**  
Open deck nestable standard pallet  
Palette grillagée emboîtable



L	A	H	Kg	Barcode	€
1.200	1.000	140	9,00	481024	<b>29,00</b>

**Palet encajable de plástico liso**  
Stackable plastic closed pallet  
Palette en plastique emboîtable lisse



**Características:**  
Superficie de apoyo: 9 patas.  
Material: HDPE.

**Characteristics:**  
Support points: 9 legs.  
Material: HDPE.

**Caractéristiques:**  
Surface d'appui: 9 plots.  
Matériel: HDPE.

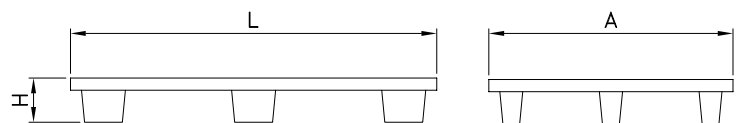

			Carga dinámica Dynamic load Charge dynamic	Carga estática Static load Charge statique			€
L	A	H	Kg	Kg	Kg	Barcode	€
1.200	800	140	1.000	2.000	6,30	481020	<b>29,00</b>
1.200	1.000	140	1.200	2.000	8,00	481021	<b>35,00</b>



**Europalet higiénico reforzado**  
Heavy duty hygienic Euro pallet  
Euro palette hygiénique renforcé

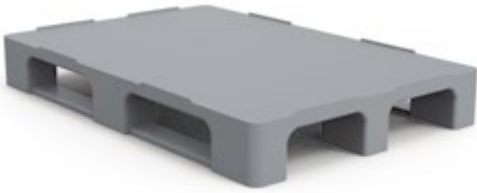

**Características:**

Superficie superior e inferior completamente lisa para una fácil limpieza.  
Rebordes perimetrales antideslizantes.  
Material: Polietileno de alta densidad en calidad alimentaria.  
Posibilidad de insertar un chip.

**Caractéristiques:**

Plateaux supérieur et inférieur complètement lisses pour nettoyage aisé.  
Rebords anti-glissement.  
Matériau: polyéthylène haute densité pour l'industrie alimentaire.  
Possibilité d'intégrer une puce.

**Characteristics:**

Upper and lower deck completely sealed for hygiene.  
Non-slipping raised edges.  
Material: High density polyethylene for food industry.  
Possibility of integrating micro-chip.

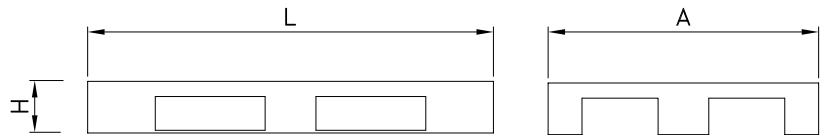

			Carga dinámica Dynamic load Charge dynamic	Carga estática Static load Charge statique			
L	A	H	Kg.	Kg.			€
1.200	800	160	1.000	5.000	18,0	481002	<b>168,00</b>

**Plataforma rodante**  
Rolling platform  
Plate-forme roulante



**\*HASTA 250 Kg**  
Up to 250 kgs of load strength  
Jusqu'à 250 kgs de résistance

**Características:**

4 ruedas giratorias de poliamida con banda de goma y horquillas de poliamida.  
Carga max. 250 kgrs.  
Material: ABS.

**Characteristics:**

4 castors in polyamide with rubber band and polyamide fork.  
Max. 250 kg.  
Material: ABS.

**Caractéristiques:**

4 roulettes en polyamide avec bande en caoutchouc et fourche en polyamide. Max. 250 kg. Matière ABS.

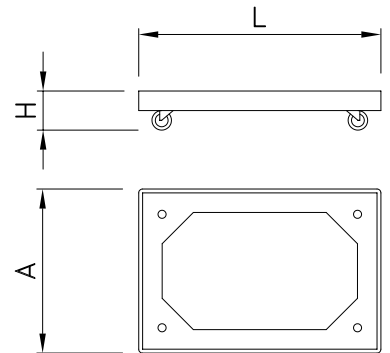

L	A	H			€
610	410	161	3,00	481060	<b>70,00</b>

**Plataforma con freno para transporte de cestos de lavavajillas**  
Dishwasher rack cart with brake  
Plate-forme pour transport de paniers de lave-vaisselle

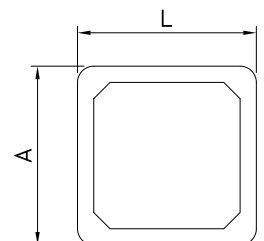

L	A			€
575	545	2,65	483016	<b>87,00</b>

## Transpaleta de acero inoxidable

Stainless steel pallet truck  
Transpalette en acier inoxydable



### Características:

Capacidad: 2000 kilos.

Todas las piezas están hechas de acero incluyendo bomba hidráulica, marco tenedor, manija, barra de empuje, teniendo, pasador y tornillo, etc. Para su uso en la carne y otros de la industria alimentaria, conservera de productos lácteos y todas las áreas donde se utilizan ácidos corrosivos y soluciones salinas. Rodillos / ruedas: Nylon.

### Characteristics:

Capacity: 2000 kg

All its parts are made in stainless steel, included the hydraulic pump, the fork frame, the handle, the pulling bar, the dowel and the screw, etc.

Specially for dairy, canning and meat industries and for food industry in general. Recommended for usage with corrosive acids and saline solutions. Rollers / wheels: nylon.

### Caractéristiques:

Capacité : 2000 kg

Toutes les pièces sont en acier y compris pompe hydraulique, cadre, manette, barre de poussée, verrou, vis. Etc.

Usage pour la viande et autre industrie alimentaire, industrie laitière et dans les domaines où l'on utilise des acides corrosifs et solutions salines. Rouleaux/roulettes nylon.

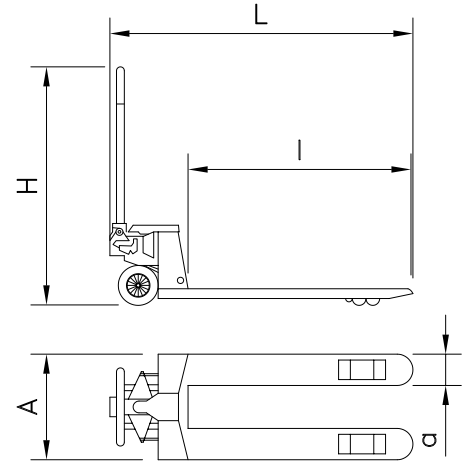

L	A	H	I	a	Kg	Barcode	€
1.550	540	1.220	1.150	160	75,00	480228	<b>3.320,00</b>

## Transpaleta pintada

Pallet truck in painted steel  
Transpalette peinte



### Características:

Capacidad: 2.500 kg.

Kit de sellado especial para prolongar la vida útil de la bomba. Horquillas reforzadas para mayor resistencia. Ruedas de entrada y salida en nylon para facilitar su movimiento. Bujes sin aceite en puntos clave para su manejo con menor fuerza y para alargar la vida de la transpaleta en general.

### Characteristics:

Capacity: 2,500 kg

Special sealing kit for an extended life of the pump.

Reinforced forks for greater resistance.

Nylon entry and exit wheels for easy moving

Oil-free bushings at key points for an effortless handling and to extend the life of the pallet truck as a whole.

### Caractéristiques:

Capacité: 2500 kg

Kit d'étanchéité spécial pour prolonger la durée de vie de la pompe.

Fourches renforcées pour une plus grande résistance.

Roulettes d'entrée et de sortie en nylon pour un mouvement facile.

Douilles sans huile aux points clés pour une manipulation avec moins de force et pour prolonger la durée de vie du transpalette en général.

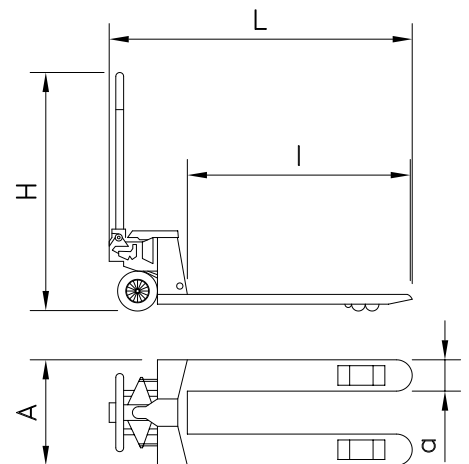

L	A	H	I	a	Kg	Barcode	€
1.550	540	1.220	1.150	160	78,00	480229	<b>750,00</b>

**Carro porta barriles de cerveza en acero inoxidable**  
 Stainless steel beer barrel trolley  
 Chariot porte baril de bière en acier inoxydable

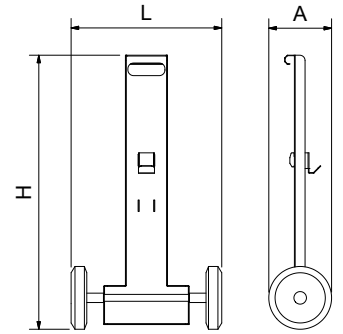

L	A	H	Kg	Barcode	€
480	200	875	6,0	084620	<b>117,00</b>

**Cutter combi (Metal detectable)**  
 Combi cutter knife Metal detectable  
 Cutter avec métal détectable combi



Juego de cuchillas de repuesto.  
 Spare scraper blades.  
 Jeu de lames de réchange.

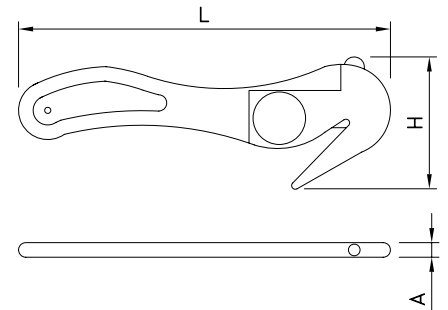
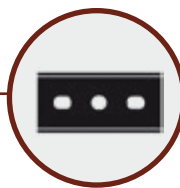

L	A	H	Gr	Barcode	€
260	4	185	72	481254	<b>21,00</b>

**Cortina de lamas de PVC**  
 PVC strip curtain  
 Ride aux à lanières en PVC

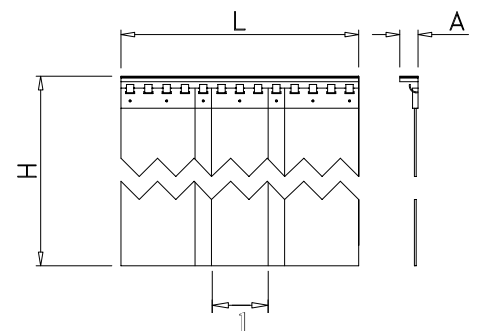

L	A	H	I	Kg	Barcode	€
984	40	2.000	200	1,35	082460	<b>150,00</b>

**Buzón de acero inoxidable apertura superior**  
 Mailbox in stainless steel, top loading  
 Boîte aux lettres en acier inoxydable avec ouverture supérieure



**N**ovedad  
 NEW  
 INNOVATION

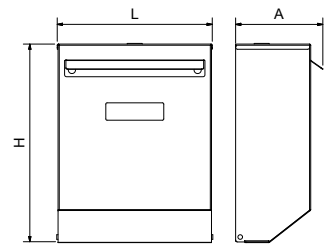

L	A	H	Kg	Barcode	€
238	137	304	1,65	083274	<b>49,00</b>

**Pincho antipalomas en acero inoxidable**  
 Stainless steel deterrent spikes for pigeons  
 Tige anti-pigeons en acier inoxydable

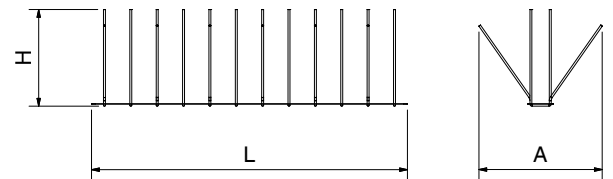
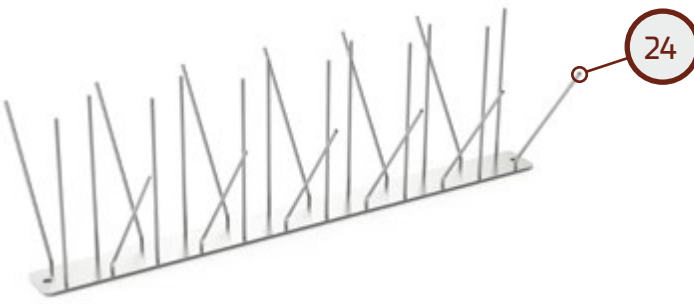

L	A	H	Gr	Barcode	€
490	191	150	350	084602	<b>21,00</b>

**Marquesina para puertas**  
 Canopy for doors  
 Auvent pour portes

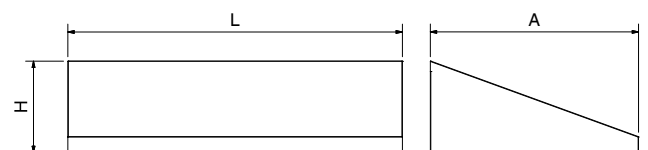

L	A	H	Kg	Barcode	€
1.270	347	790	10,88	083270	<b>323,00</b>

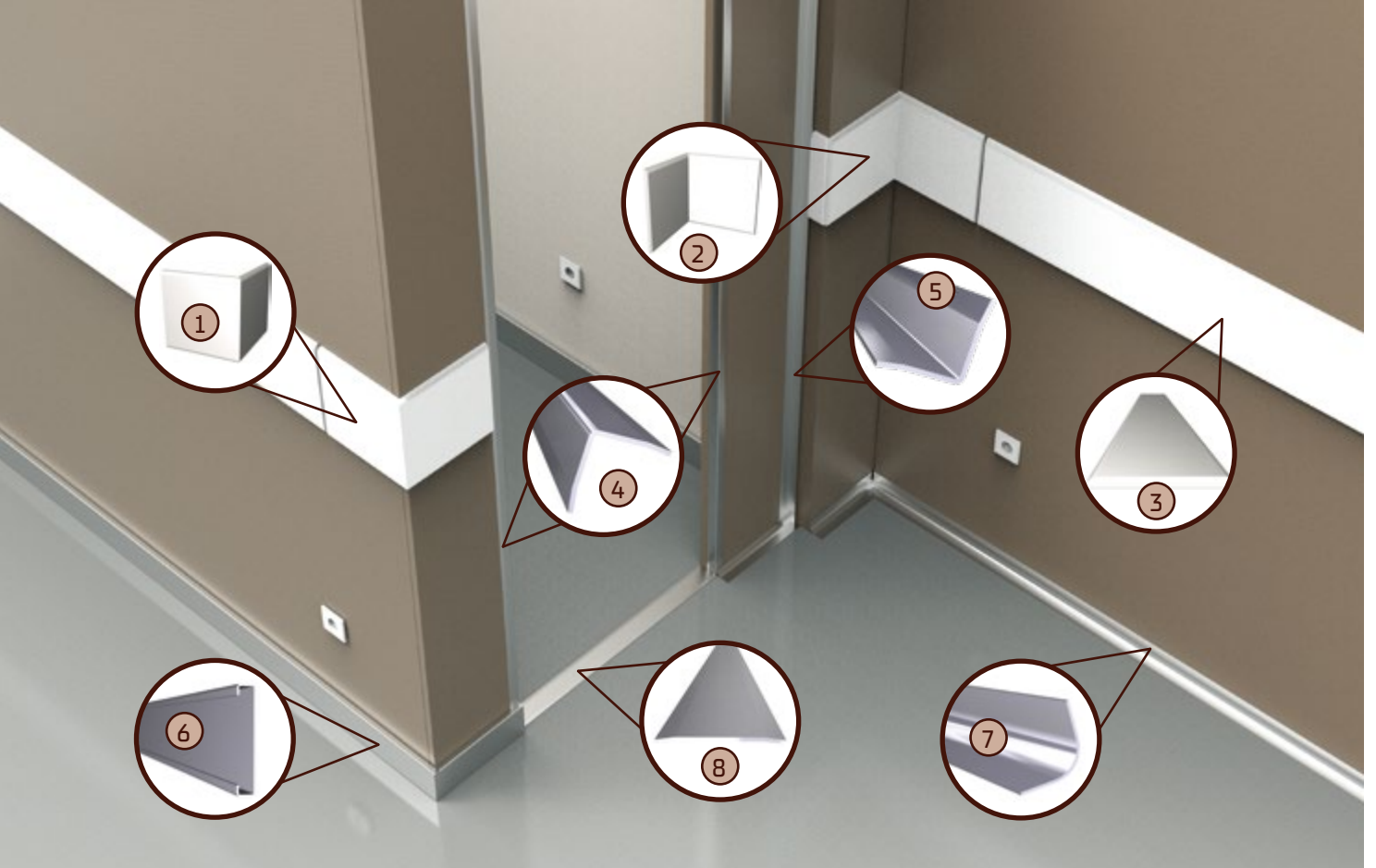

**Perfil paragolpes ángulo exterior de fibra blanca**  
 White polyethylene wall protection buffer for exterior angle  
 Pare-chocs mural d'angle extérieur en fibre blanche

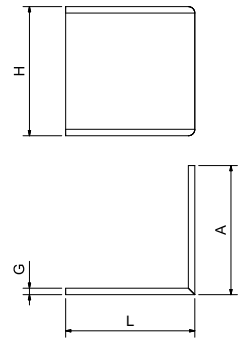

L	A	H	G	Gr	Barcode	€
200	200	200	10	80	434020	22,00

**Perfil paragolpes ángulo interior de fibra blanca**  
 White polyethylene wall protection buffer for interior corner  
 Pare-chocs mural d'angle intérieur en fibre blanche

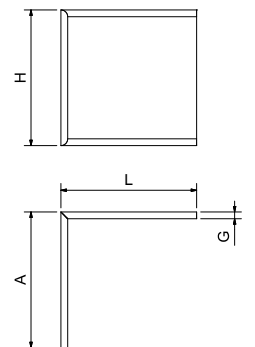
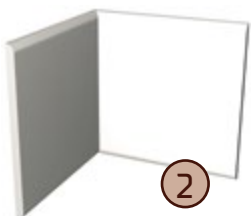

L	A	H	G	Gr	Barcode	€
200	200	200	10	80	434022	22,00

**Perfil paragolpes recto de fibra blanca**  
 Straight white polyethylene fender plinth  
 Pare-chocs mural en fibre blanche

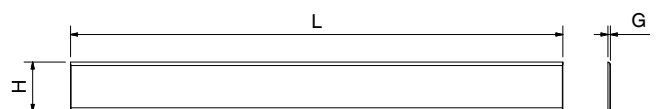

L	H	G	Gr	Barcode	€
2.000	200	10	400	434024	45,00



### Guardavivos exterior de acero inoxidable

Stainless steel external corner guard  
Baguette d'angle externe en acier inoxydable

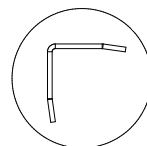
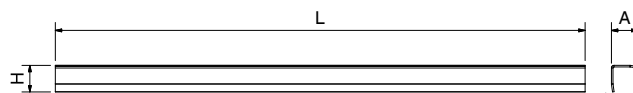

L	A	H	Kg	Barcode	€
2.000	25	25	1,20	083220	<b>20,00</b>
3.000	25	25	1,73	083222	<b>44,00</b>

### Guardavivos interior de acero inoxidable

Stainless steel internal corner guard  
Baguette d'angle interne en acier inoxydable

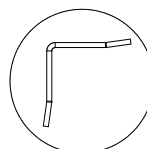

L	A	H	Kg	Barcode	€
2.000	25	25	1,20	083230	<b>20,00</b>
3.000	25	25	1,73	083232	<b>25,00</b>

### Zócalo de acero inoxidable

Stainless steel skirting board  
Plinthe en acier inoxydable

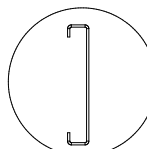
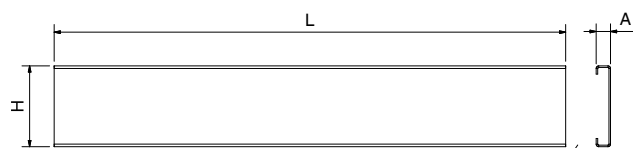

L	A	H	Kg	Barcode	€
2.000	14	79	2,67	083240	<b>35,00</b>
3.000	14	79	4,10	083242	<b>40,00</b>

### Zócalo curvo de acero inoxidable

Stainless steel curved corner guard  
Baguette d'angle en acier inoxydable courbe

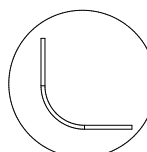
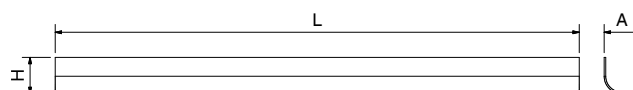

L	A	H	Kg	Barcode	€
2.000	35	35	1,50	083250	<b>35,00</b>
3.000	35	35	2,25	083252	<b>44,00</b>

### Tapajuntas de acero inoxidable

Stainless steel cover strip  
Barre de seuil en acier inoxydable

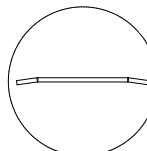
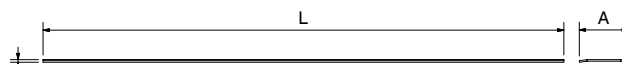

L	A	H	Kg	Barcode	€
2.000	47	3	1,20	083260	<b>22,00</b>
3.000	47	3	1,73	083262	<b>44,00</b>

### Perfil paragolpes curvo mural de plástico

Plastic wall bumpers  
Pare-chocs mural en plastique

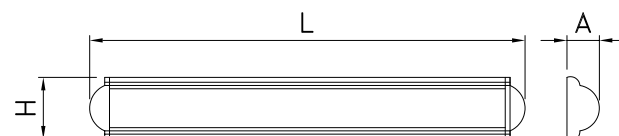
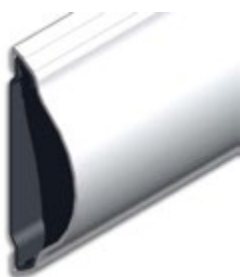

L	A	H	Gr	Barcode	€
3.000	55	100	400	482470	<b>24,00</b>
30	38	100	40	482472	<b>3,25</b>

### Consigna para carros con taquilla

Left-trolleys with locker

Consigne pour caddies avec casier

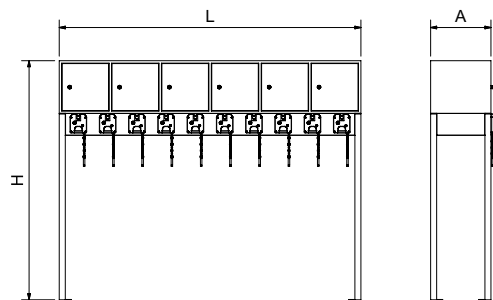

L	A	H		Kg		€
850	418	1.650	5	30,90	081428	<b>1.323,00</b>
2.000	400	1.590	10	40,00	081432	<b>2.111,00</b>

### Consigna para carros

Left-shopping trolleys

Consigne pour caddies

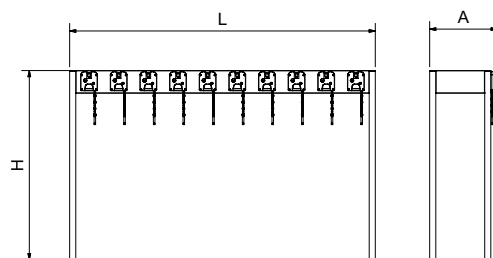

L	A	H		Kg		€
850	418	1.240	5	9,90	081426	<b>788,00</b>
2.000	400	1.240	10	24,00	081430	<b>1.481,00</b>

### Consigna mural para carros

Wall left-shopping trolleys

Consigne mural pour caddies

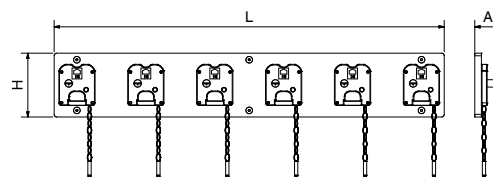

L	A	H		Kg		€
1.185	81	194	6	8	081434	<b>518,00</b>

### Taquilla - Consigna

Left-shopping - Lockers

Casiers - Consigne

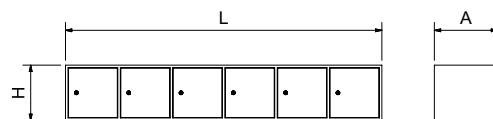













L	A	H		Kg		€
850	400	410	3	21	481437	<b>573,00</b>
2.000	400	350	6	16	481436	<b>1.145,00</b>

## Repuestos y complementos

Spare part and complements

Rechange et compléments

		Gr		€
	<b>Cerradura</b> Lock Serrure	41	481404	<b>5,50</b>
	<b>Cerradura maestra</b> Master lock Serrure master	41	481405	<b>8,50</b>
	<b>Llave maestra para cerraduras</b> Master key for locks Clé passe-partout pour serrures	10	481402	<b>4,10</b>
	<b>Cerradura de retorno de monedas</b> Coin operated lock Serrure à monnaies	790	→ 481410	<b>59,00</b>
			← 481412	
	<b>Montaje de la cerradura de retorno de monedas (no incluye cerradura)</b> Assembly coin operated lock (lock not included in this price) Assembler serrure à monnaies (serrure n'inclus pas dans ce prix)		081452	<b>34,00</b>
	<b>Pomo articulado</b> Articulated handle Poignée articulée	80	481406	<b>13,00</b>
	<b>Candado para pomo articulado</b> Padlock for articulated handle Cadenas poignée articulée	105	481408	<b>23,00</b>
	<b>Juego de herrajes para puertas (para 2 puertas)</b> Sliding doors fixtures set (valid for two doors) Set de ferrures pour portes coulissantes (valide pour deux portes)	85	073850	<b>70,00</b>
	<b>Taco regulable</b> Adjustable blocks Taquets réglables	45	409851	<b>1,50</b>
	<b>Taco regulable altura especial</b> Special height adjustable blocks Taquets réglables hauteur spéciale	115	409848	<b>3,00</b>
	<b>Juego de llaveros numerados del 1 al 6</b> Set of keyrings, numbered from 1 to 6 Ensemble de porte-cl-es numérotés de 1 à 6	30	481438	<b>3,00</b>
	<b>Juego de placas numeradas del 1 al 6</b> Set of plates, numbered from 1 to 6 Ensemble de plaques numérotées de 1 à 6	20	481439	<b>2,50</b>
	<b>Cerradura con cadena para consigna de carros</b> Locker with chain for left-shopping trolleys Serrure avec chaîne pour consigne pour caddies	850	481430	<b>66,00</b>
	<b>Cerradura electrónica para taquilla</b> Electronic lock for lockers Serrure électronique pour la porte vestiaire	584	→ 481418	<b>81,00</b>
			← 481419	
	<b>Montaje cerradura electrónica en puerta de taquilla (no incluye cerradura)</b> Installation of electronic lock for lockers (lock not included) Montage serrure électronique sur porte de vestiaire ( la serrure n'est pas incluse)		081454	<b>32,00</b>



## Cenicero con soporte y depósito de arena

Ashtray with support and tray for sand  
Cendrier avec support et plateau pour sable



### Características:

Cenicero de gran resistencia en acero inoxidable.  
Dispone de un depósito para llenarse con arena u otra sustancia inerte no inflamable para facilitar el apagado de los cigarrillos.

### Characteristics:

Stainless steel heavy duty.  
Provided with a tray to be filled with sand or another not inflammable substance to make easier the extinguishing of cigarettes.

### Caractéristiques:

Cendrier à haute résistance en acier inoxydable.  
C'est pourvu avec un plateau pour le remplir avec sable ou autre substance inerte non inflammable pour faciliter l'éteint des cigarettes.

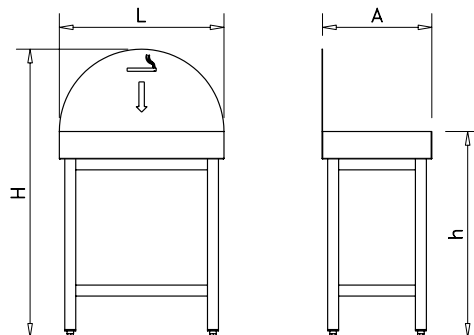

L	A	h	H	Kg	Barcode	€
600	400	750	1.050	16,6	080650	495,00

## Cenicero papelera

Ashtray - wastepaper bin  
Cendrier - poubelle inox



### Características:

Dos usos en un mismo espacio.  
Totalmente fabricada en acero inoxidable, está diseñada para usarla en exteriores.  
Incorpora recipiente GN 1/3 de profundidad 65 mm.  
Desmontable para su vaciado y limpieza. Posibilidad de lavado a máquina.  
Papelerera provista de anillas para una mejor y más cómoda colocación de sacos y bolsas.

### Characteristics:

Double use within the same space.  
Wholly made of stainless steel, it has been thought for external use.  
With a container GN 1/3 - 65 mm. depth  
Detachable for emptying and cleaning. It can be washed in the dish washer.  
Wastepaper provided of rings to put the bags inside easily.

### Caractéristiques:

Deux utilisations, même espace.  
Entièrement en acier inoxydable. Il est possible son utilisation à l'extérieur.  
Avec un récipient GN 1 / 3 - 65 mm profondeur.  
Detachable pour la vidange et le nettoyage. Il peut être lavé dans le lave-vaisselle.  
Corbeille à papier munie des anneaux pour mettre les sacs à l'intérieur facilement.

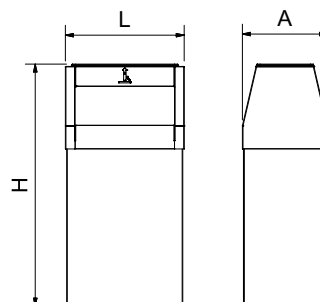

L	A	H	liters	Kg	Barcode	€
360	258	733	44 lts	6,5	080658	305,00

## Caperuza porta-cenicero para papelera

Balanced swing top with ashtray for waste bin  
Couvercle inox basculant avec cendrier pour poubelle



### Características:

Convierte la papelerera basculante en un cenicero-papelera. Dos usos en un mismo espacio.  
Totalmente fabricada en acero inoxidable, está diseñada para usarla en exteriores.  
Incorpora recipiente GN 1/3 de profundidad 65 mm.  
Desmontable para su vaciado y limpieza. Posibilidad de lavado a máquina.

### Characteristics:

Transformez votre poubelle basculante en une poubelle cendrier. Deux utilisations, même espace.  
Entièrement en acier inoxydable. Il est possible son utilisation à l'extérieur.  
Avec un récipient GN 1 / 3 - 65 mm profondeur  
Detachable pour la vidange et le nettoyage. Il peut être lavé dans le lave-vaisselle.

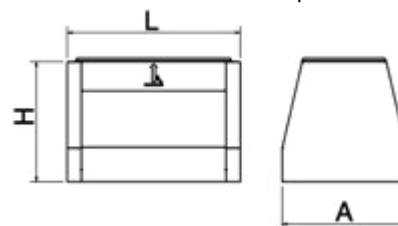

### Caractéristiques:

Turn your swing waste bin into a waste bin-ashtray. Double use within in the same space.  
Wholly made of stainless steel, it has been thought for external use.  
With a container GN 1/3 - 65 mm. depth  
Detachable for emptying and cleaning. It can be washed in the dish washer.

L	A	H	Kg	Barcode	€
360	258	260	1,9	080659	140,00

## Cenicero para espacios reducidos de pie

Floor-mounted ashtray for reduced spaces  
Cendrier inox pour espaces réduits sur pied



### Características:

Construido totalmente en acero inoxidable. Su diseño permite ocupar el mínimo espacio en el interior o exterior de su negocio. Diseñado para colocarse en cualquier rincón, incluso detrás de una puerta. Depósito de agua interior para el mejor apagado de los cigarrillos. Desmontable para su vaciado y limpieza. Posibilidad de lavado a máquina.

### Characteristics:

Wholly made of stainless steel, it has been thought to occupy little space both in indoor and outdoor areas. It can be installed anywhere in your shop, even behind the door. Inner water tank to put out cigarettes easily. Detachable for emptying and cleaning. It can be washed in the dish washer.

### Caractéristiques:

Entièrement en acier inoxydable, il a été conçu pour occuper peu de place à l'extérieur et à l'intérieur. Il peut être installé n'importe où dans votre magasin, même derrière la porte. Réservoir d'eau intérieur pour éteindre les cigarettes facilement. Détachable pour la vidange et le nettoyage. Il peut être lavé dans le lave-vaisselle.

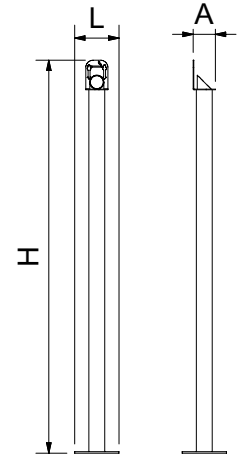

L	A	H	Kg	Barcode	€
120	60	1.064	2,3	080654	135,00

## Cenicero para espacios reducidos

Ashtray for reduced spaces  
Cendrier inox pour espaces réduits



### Características:

Diseñado para colocarse en cualquier rincón, incluso detrás de una puerta. Depósito de agua interior para el mejor apagado de los cigarrillos. Desmontable para su vaciado y limpieza. Posibilidad de lavado a máquina.

### Characteristics:

It can be installed anywhere in your shop, even behind the door. Inner water tank to put out cigarettes easily. Detachable for emptying and cleaning. It can be washed in the dish washer.

### Caractéristiques:

Il peut être installé n'importe où dans votre magasin, même derrière la porte. Réservoir d'eau intérieur pour éteindre les cigarettes facilement. Détachable pour la vidange et le nettoyage. Il peut être lavé dans le lave-vaisselle.

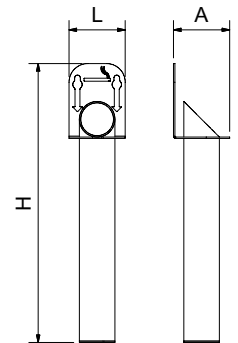

L	A	H	Kg	Barcode	€
60	60	298	0,4	080652	86,00

## Cenicero mural NF

NF wall mounted ashtray  
Cendrier mural NF



### Características:

Perfecto para exteriores.

Fácil fijación a pared.

Desmontable para su limpieza y vaciado. Posibilidad de introducirlo en máquinas de lavado.

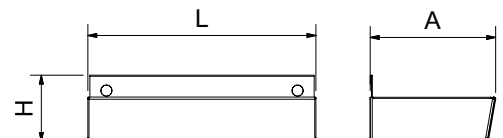

### Characteristics:

Ideal for outside  
Easy to install.  
Detachable for emptying and cleaning. It can be washed in the dish washer.

### Caractéristiques:

Ideal pour l'extérieur, mais il peut être utilisé aussi à l'intérieur.  
Facile à installer  
Détachable pour la vidange et le nettoyage. Il peut être lavé dans le lave-vaisselle.

L	A	H	Kg	Barcode	€
207	114	60	0,36	080656	21,00

**Cajones**  
Drawers  
Tiroirs



Cajón  
Drawer  
Tiroir

**Características:**

Cajones totalmente contruidos en acero inoxidable, acabado brillante. Los rodamientos de nylon en sus guías garantizan un estable movimiento de apertura y cierre, aun cuando esté cargado. Interior y exterior embutidos para aumentar su resistencia. Diseño elegante.

**Characteristics:**

Drawers completely made of stainless steel polished finished. Its nylon bearing in the rails guaranty a stable opening-closing movement, even when loaded. Hammered inside and outside to increase its strenght. Smart design.

**Caractéristiques:**

Tiroirs totalement construit en acier inoxydable avec finition brillant. Les roulements de nylon dans ses glissières garantissent le mouvement équilibré d'ouverture et de fermeture bien qu'il soit chargé. Intérieur et extérieur embouti pour augmenter sa résistance. Dessin élegant.



Cajón con cerradura  
Lock drawer  
Tiroir avec serrure



Cajón con golpeador para posos de café  
Drawer with striker for coffee grounds  
Tiroir avec dispositif pour faire tomber le marc de café



Cajón alto  
Deep drawer  
Tiroir haut

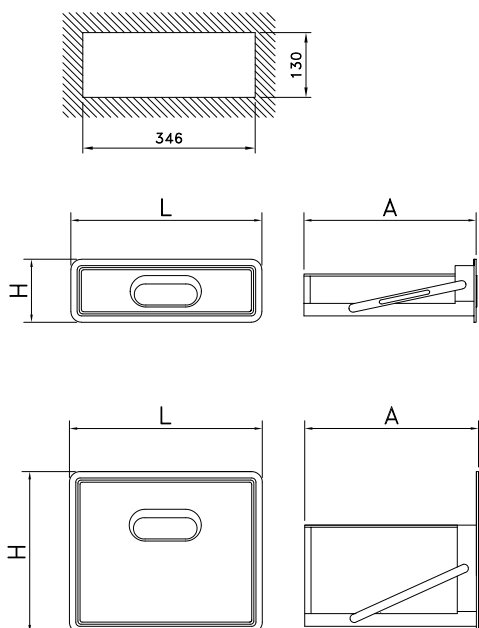

L	A	H	Kg	Barcode	€
---	---	---	----	---------	---



375 405 160 2,8 485402 **155,00**



375 405 160 2,9 485404 **204,00**



375 405 160 3,0 485406 **184,00**



470 495 410 5,2 485414 **390,00**

## Cajón o tolva acoplado a estantería

Drawer or hopper coupled to shelves

Tiroir ou trémie accouplé aux étagères







Estanterías ancho 500 mm Shelving units depth 500 mm Rayonnages profondeur 500 mm		Estanterías ancho 600 mm Shelving units depth 600 mm Rayonnages profondeur 600 mm	
---	--	---	--



€



€

	085430	<b>293,00</b>	085432	<b>297,00</b>
	085434	<b>340,00</b>	085436	<b>344,00</b>
	085438	<b>303,00</b>	085440	<b>308,00</b>
	085468	<b>510,00</b>	085470	<b>520,00</b>



Los precios de esta sección incluyen el cajón, el envoltente, los refuerzos y la mano de obra de acoplar a nuestros estantes.

Fringe, reinforcements, drawer and shelf fixing labour are included in the price.

Enveloppant, renforts, tiroir et la main d'œuvre pour les fixer aux étagères c'est inclus dans le prix.

## Cajón o tolva preparado para acoplar a estantería por el cliente

Drawer or hopper designed to be coupled to shelves by the user





Tiroir ou trémie dessiné pour être accouplé aux étagères par l'utilisateur



Estanterías ancho 500 mm Shelving units depth 500 mm Rayonnages profondeur 500 mm		Estanterías ancho 600 mm Shelving units depth 600 mm Rayonnages profondeur 600 mm	
---	--	---	--

Composición Composition Composition		Composición Composition Composition	
---	--	---	--

Unidades Units Unités	Barcode	€	Unidades Units Unités	Barcode	€
-----------------------------	---------	---	-----------------------------	---------	---

	1	085410	<b>281,00</b>	1	085410	<b>281,00</b>
	2	085418		2	085420	
	1	085412	<b>331,00</b>	1	085412	<b>331,00</b>
	2	085418		2	085420	
	1	085414	<b>300,00</b>	1	085414	<b>300,00</b>
	2	085418		2	085420	
	1	085464	<b>534,00</b>	1	085464	<b>534,00</b>
	2	085418		2	085420	



Estos cajones y tolvas están especialmente diseñados para ser acoplados mediante tornillos o remaches a nuestras estanterías. Los precios incluyen el cajón, el envoltente y los refuerzos necesarios para su fácil adaptación al estante.

These screw or rivet fixing drawers and hoppers are specially designed to be easily adapted to our shelves. Fringe, reinforcements, drawer and shelf fixing labour are included in the price.

Ces tiroirs et trémies de fixation par visés ou rivetages ont été dessinés par une facile adaptation à l'étagère. Enveloppant, renforts, tiroir et la main d'œuvre pour les fixer aux étagères c'est inclus dans le prix.



## Cajón o tolva acoplado

Drawer or hopper coupled  
Tiroir ou trémie accouplé



Los precios de esta sección incluyen el cajón, la mano de obra y los materiales necesarios para acoplar estos elementos a los muebles que precisen. Usualmente se suelen acoplar en tajos de troceo, fregaderos, mesas de trabajo, etc.

The prices shown in this section include the drawer plus the labour as well as the necessary materials to couple these elements in the provided furniture. Usually they are coupled in shelves, chopping blocks, sinks, preparation tables, etc.

Les prix de ce partie comprennent le tiroir plus la main-d'oeuvre et les matériels nécessaires pour accoupler ces éléments à les meubles qu'ils aient besoin. Usuellement ils sont accouplés sur rayonnages, hachoirs à viande, eviers, tables de préparation, etc.

Modelo Model Model		€
	085402	<b>254,00</b>
	085404	<b>290,00</b>
	085406	<b>261,00</b>
	085408	<b>332,00</b>
	085460	<b>526,00</b>
	085480	<b>200,00</b>
	085482	<b>282,00</b>

## Cajón o tolva preparado para acoplar por el cliente

Drawer or hopper designed to be coupled by the user  
Tiroir ou trémie dessiné pour être accouplé par l'utilisateur



Estos cajones y tolvas están especialmente diseñados para ser acoplados mediante tornillos o remaches. Incorporan un envolvente taladrado en sus pestañas superiores de tal manera que puede adaptarse a cualquier mesa del mercado.

The screw or rivet fixing drawers and hoppers are provided with a stainless steel fringe pierced in the upper part in order to be adapted to any table.

Les tiroirs et trémies de fixation par vises ou rivetages incorporent un enveloppant en acier inoxydable perforé dans ses languettes supérieures tellement qu'il est possible l'adapter à quelque table.

Modelo Model Model		€
	085410	<b>220,00</b>
	085412	<b>285,00</b>
	085414	<b>254,00</b>
	085464	<b>488,00</b>
	085490	<b>170,00</b>
	085492	<b>232,00</b>



### Tolva abatible para posos de café

Hinged hopper for coffee grounds  
Trémie à un abattant pour marc de café

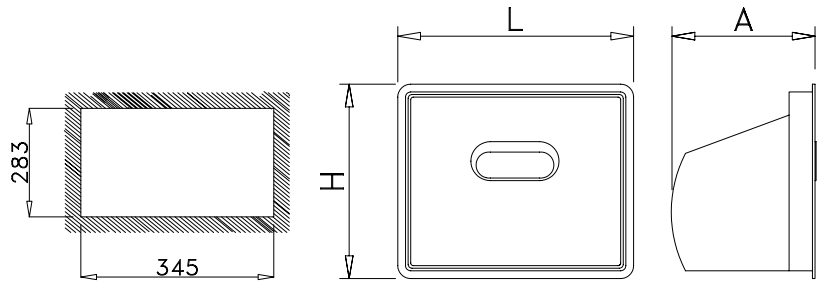

L	A	H	Kg	Barcode	€
370	240	303	3,53	485408	<b>249,00</b>

### Puerta

Door  
Porte

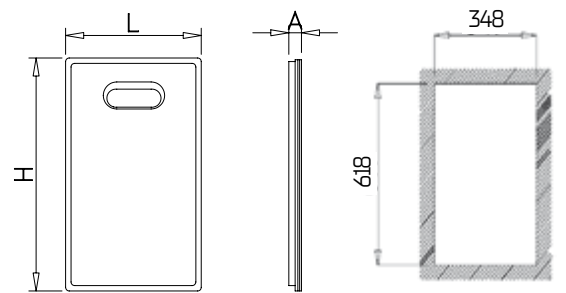

L	A	H	Kg	Barcode	€
373	35	643	6,8	485602	<b>204,00</b>

### Repuesto golpeador de posos de café

Spare striker for coffee grounds  
Dispositif de remplacement pour faire tomber le marc de café

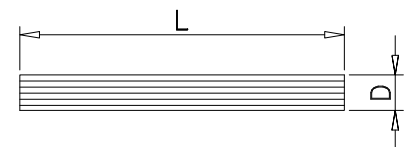
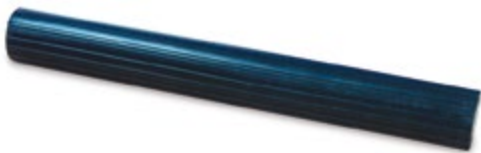

L	D	Kg	Barcode	€
320	40	1,85	485410	<b>44,00</b>

### Kit golpeador para cajón pequeño

Coffee grounds striker kit for small drawer  
Barre pour petit tiroir de marc à café



L	A	H	Kg	Barcode	€
430	79	139	2,5	2720108	<b>42,00</b>

⚠ Valido solo para cajones Fricosmos.  
Valid only for Fricosmos drawers.  
Valable uniquement pour les tiroirs Fricosmos.



**Características:**

Disponemos de dos tipos de rueda: una más económica, cuya estructura está fabricada en acero galvanizado, siendo su superficie rodante de goma, y otra construida en acero inoxidable, con su superficie rodante de nylon. El acero inoxidable y el nylon ofrecen una duración y resistencia garantizada, por lo que son ideales para mataderos, salas de despiece y demás sitios donde el grado de humedad sea elevado.

**Characteristics:**

Two sort of wheels are available: an economic one, which structure is made in galvanized steel, with a rolling surface in rubber, an another one made in stainless steel with its rolling surface in nylon. The stainless steel and the nylon offer a guaranteed length and resistance, and because of this, they are ideal for slaughterhouses, cutting up rooms, workshops, and places with high humidity concentration.

**Caractéristiques:**

Il y a deux types de rouelles, une plus économique, dont structure est fabriquée en acier galvanisé avec une surface roulante de caoutchouc, l'autre construite en acier inoxydable avec sa surface roulante en nylon. L'acier inoxydable et le nylon offrent une durée et résistance garanties, ce qui fait que ce soit idéal pour abattoirs, salles d'équarriment, ateliers et autres lieux avec une haute concentration d'humidité.

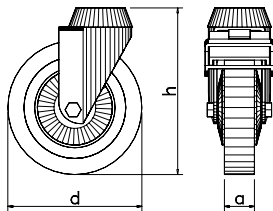

Inox - Nylon

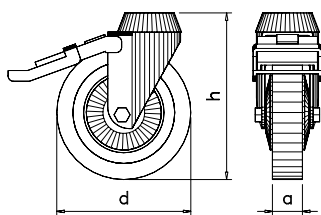

Galvanizadas  
Goma



							Resistencia por rueda Castor load strength Résistance de charge par rouelle	
d	a	h	Kg	Gr	Barcode	€		
80	33	106	100	570	485032	<b>25,00</b>		
130	40	157	180	890	485036	<b>39,00</b>		
80	33	106	100	810	485030	<b>33,00</b>		
130	40	157	180	1.140	485034	<b>53,00</b>		
75	23	94	50	300	485004	<b>8,00</b>		
125	32	155	100	725	485012	<b>17,00</b>		
75	23	94	50	370	485002	<b>9,00</b>		
125	32	155	100	800	485010	<b>21,00</b>		



**Rueda anticalórica con freno en acero inoxidable ø100 mm**  
Heat resistant swivel wheel with brake in stainless steel ø100 mm  
Roulette résistante à la chaleur avec frein en acier inoxydable ø100 mm



175 Kg. -40 a 280°C 840 485026 **70,00**



**Rueda anticalórica en acero inoxidable ø100 mm**  
Heat resistant swivel wheel in stainless steel ø100 mm  
Roulette résistante à la chaleur en acier inoxydable ø100 mm



175 Kg. -40 a 280°C 840 485028 **55,00**

## Ruedas acopladas

Coupled wheels  
Rouelles accouplées



- El precio comprende el montaje de 4 ruedas por elemento. El precio de las ruedas no está incluido.

The price includes the assembly of 4 castors per element. The price of the castors is not included.

Le prix comprend l'assemblage de 4 rouelles par élément. Le prix des rouelles n'est pas compris.

### Características:

Este apartado les será útil si lo que desean es acoplar ruedas a algún artículo de nuestro catálogo. Generalmente las ruedas suelen ser acopladas en estanterías, tajos de troceo, fregaderos, mesas, etc. La forma de aplicar los precios es sumar el precio de la rueda deseada mas el acoplamiento. Por ejemplo, tenemos una mesa que necesitamos que lleve ruedas y queremos obtener el precio de las ruedas colocadas. En primer lugar tendríamos que seleccionar una rueda entre las disponibles y en este caso seleccionamos la de acero inoxidable con freno de 80 mm de altura. La operación sería la siguiente:  
4 ruedas del código 485030 + 4 acoplar rueda a pata de 40x40 mm código 085002.

### Characteristics:

This part will be useful if what you wish is to assembly wheels to any article of our catalogue. Wheels are usually coupled in shelves, chopping blocks, sinks, tables, etc. The way of applying prices is to add the price of each one of the required wheels plus the assembly. For example, if you need a table with wheels and you want to obtain the price of the wheels assembled, first you should select one of the available wheels. In the case that you select the one in stainless steel of 80 mm height with brake, the result is as follows:  
4 wheels code 485030 + assembly wheel to 40x40 mm leg code 085002.

### Caractéristiques:

Cette partie vous sera d'utilité si vous desirez accoupler rouelles a quelque article de notre catalogue. En général les rouelles coutume d'être accouplées en rayonnages, hachoirs à viande, évier, tableaux, etc. La forme d'appliquer les prix c'est ajouter le prix du rouelle désirée plus le prix de l'accouplement. Par exemple, si vous avez besoin d'un tableau avec rouelles et vous voulez obtenir le prix des rouelles couplées, d'abord vous devriez sélectionner une rouelle entre les disponibles. Dans le cas de sélectionner celle d'acier inoxydable de 80 mm d'hauteur avec frein, l'opération serait la suivante:  
4 rouelles du code 485030 + accoupler rouelle dans empiètement 40x40 mm code 085002.



Acoplar rueda a soporte de estantería Assembly wheel to shelving support Accoupler rouelle dans support de rayonnage	085004	10,00
Acoplar rueda a pata de 40x40 mm. Assembly wheel to 40x40 mm. leg Accoupler rouelle dans empiètement de 40x40 mm.	085002	22,00
Acoplar ruedas a soporte para mostrador de pescadería Assembly of castors to fish counter support Assemblage de rouelles au support d'étal à poisson	085008	50,00
Acoplar ruedas a boxes modulares Assembly of castors to modular boxes Assemblage de rouelles au boxes modulaires	085010	50,00
Acoplar ruedas a palet de jamones/embutidos Assembly of castors to palet for cured hams/ sausages and cured meat Assemblage de rouelles au palette pour jambons/charcuterie	085012	94,00

## Kit de acoplamiento a rueda

Wheel fixing kit  
Kit d'accouplement aux rouelle



### Características:

Con este producto usted podrá acoplar las ruedas del catálogo a nuestros artículos.

### Characteristics:

This article will enable the fixing of any wheel of the catalogue to our products.

### Caractéristiques:

Cet article vous permettra la fixation de quelque rouelle du catalogue à nos produits.



200 085006 12,00

## Adaptador enchufe tipo G

Type G plug adapter  
Adaptateur pour prise électrique type G



Tensión Voltage Tension	Frecuencia Frequency Fréquence	Gr	Barcode	€
220 V	50 Hz	56	485878	<b>8,00</b>

## Taco regulable para soporte de estantería

Adjustable block for shelving support  
Taquet réglable pour supports de rayonnage



### Características:

Material altamente resistente. Rosca interior reforzada.  
Cumplen con todas las normativas.  
Para ángulo de 40x40x2 mm (Soportes estanterías)

### Characteristics:

High resistance material, since it has a reinforced internal thread.  
It complies all the current norms.  
For angled bars 40x40x2 mm

### Caractéristiques:

Matériel d'haute résistance, puisqu'il a une filet intérieur renforcée. Il accomplit toutes les normes en vigueur.  
Pour bars en angle de 40x40x2 mm

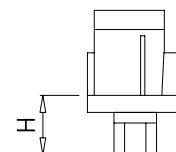

Gr	H <sub>1</sub>	H <sub>2</sub>	Barcode	€
45	28	50	411018	<b>2,78</b>

## Tacos regulables para tubo

Adjustable blocks for tube  
Taquets réglables pour tube



### Características:

Material altamente resistente. Al llevar rosca interior cumplen con todas las normativas vigentes.

### Characteristics:

High resistance material. Since it has thread inside, is in accordance with all the current norms.

### Caractéristiques:

Matériel d'haute resistance. Puisqu'il a une filet intérieur, il accomplit toutes les normes en vigueur.

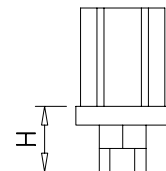

Para tubo de For tube of Pour tube de	Gr	H <sub>1</sub>	H <sub>2</sub>	Barcode	€
40x40x1 mm	45	28	50	409851	<b>1,50</b>
40x40x1,5 mm					
Ø 38x1,5 mm	40	35	60	409852	<b>4,10</b>

## Taco regulable altura especial para tubo

Special height adjustable block for tube  
Taquet réglable hauteur spéciale pour tube

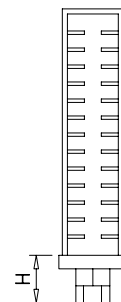

Para tubo de For tube of Pour tube de	Gr	H <sub>1</sub>	H <sub>2</sub>	Barcode	€
40x40x1 mm					
40x40x1,5 mm	115	30	105	409848	<b>3,00</b>

## Tacos de plástico para tubo

Plastic blocks for tube

Taquets de plastique pour tube



### Características:

Para tubo de 1 mm y 1.5 mm de espesor. Material altamente resistente. Las aletas dispuestas horizontalmente garantizan un máximo ajuste.

### Characteristics:

High resistance material. The flaps horizontally disposed guaranty the maximum adjustment.

### Caractéristiques:

Matériel d'haute resistance. Les ailettes ordonnées horizontalement garantissent le maximum ajustage.

Para tubo de For tube of Pour tube de	Gr	Barcode	€
20x10 mm	2	409812	<b>0,16</b>
20x20 mm	4	409810	<b>0,18</b>
25x25 mm	5	409808	<b>0,19</b>
30x30 mm	8	409806	<b>0,22</b>
40x20 mm	6	409804	<b>0,24</b>
40x30 mm	9	409803	<b>0,27</b>
40x40 mm	11	409802	<b>0,32</b>

Para tubo de For tube of Pour tube de	Gr	Barcode	€
Ø 20 mm	3	409886	<b>0,17</b>
Ø 25 mm	4	409888	<b>0,18</b>
Ø 30 mm	5	409890	<b>0,20</b>
Ø 35 mm	8	409892	<b>0,24</b>
Ø 38 mm	9	409894	<b>0,25</b>
Ø 42 mm	10	409896	<b>0,26</b>

## Funda antivibradora para taco regulable

Antivibrator cover for adjustable blocks

Base anti-vibrateur pour taquets réglables

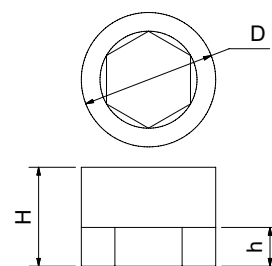
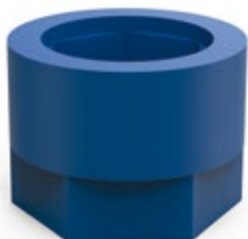

D	H	h	Gr	Barcode	€
35	25	10	15	409952	<b>1,31</b>

## Pasacable inox

Stainless steel grommet

Passe-câbles en acier inoxydable

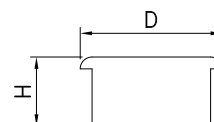

H	D	Gr	Barcode	€
35	72	90	409835	<b>22,00</b>

## Aros para tolva de desbarasado

Rings for waste chutes  
Cercles pour trémies à déchets

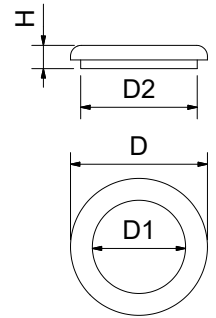

D	D1	D2	H		Gr	Barcode	€
235	165	200	44		450	486402	<b>20,00</b>
235	165	200	44		450	486406	<b>20,00</b>
235	165	200	44		450	486408	<b>20,00</b>
235	165	200	44		450	486410	<b>20,00</b>
235	165	200	44		450	486412	<b>20,00</b>

## Tapa para aro de tolva de desbarasado

Lid for Rings for waste chutes  
Couvercle pour cercles pour trémies à déchets

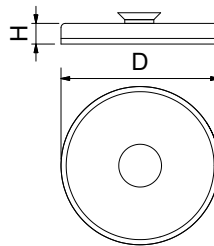

D	D1	H	Gr	Barcode	€
240	180	26	265	486404	<b>19,00</b>

## Limpiador de acero inoxidable

Stainless steel cleaner  
Laveur d'acier inoxydable



### Características:

Este producto de alta calidad tiene como principales ventajas su elevada evaporación y secado lo que proporciona una limpieza rápida, eficaz y duradera. No deja cercos ni restregones. Por su neutralidad no ataca el acero conservándolo en perfectas condiciones durante más tiempo.

### Aplicación:

Este limpiador se recomienda para cualquier superficie de acero inoxidable.

### Characteristics:

This high quality product has, as main advantage, a high degree of evaporation and drying, which provides a quick, effective and lasting cleaning. It does not leave any cleaning or rubbing traces. Because of its neutrality this product does not attack the steel and keeps it in perfect conditions for longer.

### Use:

This cleaner is recommended for any kind of stainless steel surface.

### Caractéristiques:

Ce produit d'haute qualité a comme principale avantage son élevé évaporation et séchage, ce qui rapporte un nettoyage rapide, effectif et durable. Ce ne fait pas traces des frottements. A cause de sa neutralité n'attaque pas l'acier et le conserve en parfait conditions pendant plus longtemps.

### Applications:

On recommande ce nettoyeur pour quelque surface en acier inoxydable.



Gr	Barcode	€
1lts	850 380004	<b>18,00</b>

## Spray de acero inoxidable

Stainless steel spray  
E spray acier inoxydable



Reacondicionamiento de piezas de acero inoxidable, rejillas, tuberías, instalaciones exteriores, decoración, etc.

Es un revestimiento superficial, a base de pigmentos minúsculos de acero inoxidable y resina acrílica, que se adhiere a superficies metálicas, vidrio, madera, piedra, papel, plástico, etc. Soporta temperaturas de hasta 300°C durante periodos cortos. A las 4-6 horas después del secado es resistente a la abrasión y a agentes químicos.

Repairing of stainless steel parts, grills, pipes, outdoor installations, decorating, etc.

It is a superficial coating, from stainless steel and acrylic resin micro-pigments, which is adhered to metallic surfaces, glass, wood, stone, paper, plastic, etc. It supports temperatures up to 300°C for short periods. Between 4-6 hours after having dried, is abrasion and chemical agents resistant.

Aménagement des pièces en acier inoxydable, grillages, conduits, installations extérieures, décoration, etc.

C'est un revêtement superficiel, composé de micro pigments en acier inoxydable et résine acrylique, qui s'adhère aux surfaces métalliques, verre, bois, pierre, papier, plastic, etc.

Il supporte des températures jusque 300°C pendant périodes brèves. Après 4-6 heures de séchage c'est résistant à l'abrasion et aux agents chimiques.

Gr	Barcode	€
400 ml.	410 480002	<b>14,00</b>



# ÍNDICE ANALÍTICO

ANALYTICAL TABLE OF CONTENTS  
INDEX ANALYTIQUE

C

I

H

G

M

L



# Índice analítico

## Símbolos

10 W - Luz LED blanca (E27 x 135), 383  
18 W - UV-A LED repuesto para exterminador LD120, 383  
20 W - Luz negra (E27 x 160), 383

## A

Abrazadera sin fin de 25-40 mm. para manguera, 332  
Abre ostras de polietileno, 114  
Abre ostras manual profesional en acero inoxidable, 114  
Abrebotellas, 170  
Abrelatas, 143  
Abrelatas industrial, 144  
Abrelatas tenaza, 143  
Abreostras, 113  
Abreostras profesional de sobremesa en acero inoxidable, 114  
Abreostras sobremesa, 113  
Acanalador, 129  
Accesorios, 374  
Accesorios para columnas de gel, 417  
Accesorios para estanterías, 35  
Accesorios para fuentes M 3/8", 214  
Accesorios para grifos de manguera, 268  
Accesorios para lavamanos portátiles autónomos, 192  
Acoplamiento de grifo ducha serie basic a encimera, 276  
Acoplar a estante fibra, 52  
Acoplar a estante inox, 52  
Acoplar portacuchillos, 74, 136, 138  
Acoplar rueda a pata de 40x40 mm., 497  
Acoplar rueda a soporte de estantería, 497  
Acoplar ruedas a boxes modulares, 497  
Acoplar ruedas a palet de jamones/embutidos, 497  
Acoplar ruedas a soporte para mostrador de pescadería, 497  
Adaptador de cestillos cuberteros para carros de servicio, 320  
Adaptador de contenedores para carros de servicio, 320  
Adaptador de cubetas GN 1/3 y 1/6 para carros de servicio, 320  
Adaptador enchufe tipo G, 498  
Adaptador enchufe tipo H, 384  
Adaptador H de 1/2" a H de 1/2", 268  
Adaptador H de 3/8" a M de 1/2", 268  
Adaptador para cartucho 462828 y leva 462842, 281  
Adaptador para mástil, 278  
Adhesivo hierba., 332  
Adhesivo modelo "Ola", 332  
Adhesivo para pedal, 311, 388  
Adhesivo para trampilla, 311, 388

## B

Bacaladera, 113  
Balanza de cocina digital 5 kg, 151  
Balanza digital de precisión 1kg, 152  
Balanza mecánica de cocina, 151  
Balasto (Reactancia) para UK-240, 383  
Balasto (Reactancia) para UK-40 y UK-80, 383  
Banco de vestuario en acero inoxidable y polietileno, 350  
Bandeja de aluminio con asas para pizza 6 porciones, 154  
Bandeja de aluminio con mango para pizza 6 porciones, 154  
Bandeja de camarero de acero inoxidable especial jarras de cerveza, 449  
Bandeja de cambio, 450  
Bandeja de cambio rectangular con clip, 450  
Bandeja de cambio sencilla, 450  
Bandeja de comedor autoservicio inox, 449  
Bandeja de exposición para helados en vaso, 434

7 W - Bombilla UV-A LED repuesto para exterminadores LED, 383  
8 W - UV-A LED repuesto para exterminador SP-80 LED, 383

Adhesivo Reciclaje, 392  
Adhesivo reciclar Envases y plásticos, 392  
Adhesivo reciclar Materia orgánica, 392  
Adhesivo reciclar Papel y cartón, 392  
Adhesivo reciclar Vidrio, 392  
Adhesivo ventana, 375  
Afilador cuchillos manual de sobremesa, 134  
Afilador de cuchillos de sobremesa, 135  
Afilador de cuchillos eléctrico mini, 135  
Afilador de cuchillos manual de sobremesa, 135  
Afilador de cuchillos profesional, 135  
Aguja de mechar, 127  
Aireador cromado fijo para grifo, 260  
Aireador cromado orientable para grifo, 260  
Anillo acero inox antigoteo para botella de vino, 172  
Aplasta hamburguesas circular, 93  
Aplasta hamburguesas de molde ovalado, 94  
Aplasta hamburguesas de molde redondo, 95  
Aplasta hamburguesas higiénico doble, 94  
Aplastafiletas, 131  
Aplastafiletas circular, 131  
Arandelas, 66  
Armario / vitrina para hospitales y salas médicas, 346  
Armario botiquín, 404  
Armario de esquina derecha con puertas abatibles, 343  
Armario de esquina izquierda con puertas abatibles, 343  
Armario estantería 2 puertas, 345  
Armario esterilizador de cuchillos mediante Ozono, 372  
Armario inox esterilizador de utillaje y calzado, 373  
Armario para equipos informáticos, 347  
Armario para productos de limpieza, 344  
Armarios de puertas abatibles, 342  
Armarios de puertas correderas, 342  
Armarios esterilizadores de cuchillos rayos U.V., 371  
Aro azul con trampilla para contenedor de reciclaje vertical, 392  
Aros para tolva de desbarasado, 500  
Asa universal para cubetas Gastronorm, 446  
Asiento abatible, 402  
Atrapador de insectos Easy Trap, 381  
Atrapador de insectos Tephri Trap, 381  
Atril de acero inoxidable, 347

Bandeja de exposición para helados polos, 434  
Bandeja de frío GN cold plate, 166  
Bandeja de panadería acanalada en aluminio 600x400 mm., 451  
Bandeja Euronorm autoservicio en polipropileno azul, 448  
Bandeja Euronorm autoservicio en polipropileno azul con asas, 448  
Bandeja Gastronorm de presentación BP3, 447  
Bandeja inoxidable con asa, 448  
Bandeja isotérmica polipropileno Euronorm 1/1 para colectividades 5 compartimentos, 449  
Bandeja menú inoxidable, 448  
Bandeja para marisco, 452  
Bandeja pastelera en acero inoxidable, 451  
Bandeja pastelera perforada, 451  
Bandeja perforada para mostrador de pescadería, 332  
Bandejas aluminio antiadherente, 450



Bandejas de camarero de acero inoxidable, 449  
 Bandejas de presentación, 447  
 Bandejas de presentación BP2, 447  
 Bandejas de presentación inox, 447  
 Barbacoa portátil profesional de sobremesa y acero inoxidable, 166  
 Barra de apoyo abatible. Anclaje a suelo, 402  
 Barra de apoyo mural horizontal, 402  
 Barra de apoyo mural horizontal pasamanos, 402  
 Barra de apoyo mural para bañera, 401  
 Barra de apoyo mural para lavabo, 401  
 Barra de apoyo mural vertical abatible, 401  
 Barra de apoyo recta, 401  
 Barra mural con ganchos, 49  
 Barra para colgar accesorios, 375  
 Barreños, 408  
 Base rodante galvanizada, 322  
 Bases inoxidables para transporte de pizzas, 157  
 Bastidor para carro de servicio, 321  
 Batidor, 141  
 Biberones de cocina, 149  
 Bidón apilable blanco 15L para fregadero autónomo, 201  
 Bidón apilable blanco 25L para fregadero autónomo, 201  
 Bidón apilable translúcido 20 lts para fregadero autónomo, 201

## C

Cabezal para filtro 3M y CARBA (Futura fría, Cold+ y Enfriador de agua), 214  
 Cabezal para filtro Bestmax (Futura fría y caliente), 214  
 Cadena eslabón largo según norma DIN 763 ø5 A4, 52  
 Cafetera express inox, 175  
 Cafetera italiana tradicional 6 ó 12 tazas, 175  
 Caja alimentaria apilable, 457  
 Caja alimentaria apilable perforada para masa, 457  
 Caja apilable multiusos 65 L., 455  
 Caja de 10.000 guantes desechables (100 bolsas de 100 unidades), 400  
 Caja de 10.000 guantes desechables con agujero para colgar (100 bolsas de 100 unidades), 400  
 Caja de 50 fundas desechables para carro de Euronorm / Gastronorm, 325  
 Caja de reparto/distribución apilable con tapa, 176, 452  
 Cajón acoplado, 347  
 Cajón acoplado a estante 2/1 imagine, 30  
 Cajón alto, 492  
 Cajón con cerradura, 492  
 Cajón con golpeador para posos de café, 492  
 Cajón liso apilable gris, 455  
 Cajón liso especial para carne, 455  
 Cajón o tolva acoplado, 494  
 Cajón o tolva acoplado a estantería, 493  
 Cajón o tolva preparado para acoplar a estantería por el cliente, 493  
 Cajón o tolva preparado para acoplar por el cliente, 494  
 Cajón para pescado o marisco con drenaje, 455  
 Cajonera para mesa mural con cartelas (400 mm.), 289  
 Cajones, 492  
 Calentador de agua instantáneo, 198, 233  
 Calentador de platos mediante aire, 316  
 Calentador de platos para estante de sobremesa, 315  
 Calzo elevador para fibra, 81  
 Cambiador de pañales horizontal plegable, 413  
 Campana extractora mural acero inoxidable, 318  
 Canal colector industrial para interiores en acero inoxidable, 239  
 Candado para pomo articulado, 351, 489  
 Caño 200 mm. de repuesto para grifo monomando sobremesa 463242, 277  
 Caño acoplable a grifo ducha, 276  
 Caño acoplable a mástil de grifo ducha 200mm., 276  
 Caño acoplable a mástil de grifo ducha 250mm., 276  
 Caño bajo de 200mm. para válvulas, 276  
 Caño bajo de repuesto para grifo monoblock 463234, 276  
 Caño blanco de repuesto para grifo 464633, 277  
 Caño ducha extraíble, 260

Bidón de 10 lts, 301  
 Bidón de 10 lts para lavamanos autónomo, 201  
 Bisagra de piano inox, 66  
 Bolsa de tornillería y juntas (repuesto) para grifo ducha, 275  
 Bolsa térmica para transporte de pizza, 157  
 Bolsas colgantes 350x450, 400  
 Bolsas de paraguas para dispensador - 200 ud., 472  
 Bomba de vacío para botella de vino, 172  
 Bombilla calentadora inastillable, 315  
 Bombilla LED antimosquitos, 378  
 Botas de agua PVC/Nitrilo, 359  
 Botellero, 301  
 Botellero de sobremesa para botellas de vino, 37  
 Botellero expositor inox de sobremesa para botellas de vino, 38  
 Botelleros, 462  
 Bowl de acero inoxidable, 162  
 Bowls en policarbonato transparente, 162  
 Box modular 1 cajón y puerta, 312  
 Box modular 1 puerta, 312  
 Box modular 4 cajones, 312  
 Box modular guías GN, 312  
 Boxes modulares, 312  
 Buzón de acero inoxidable apertura superior, 485

Caño fijo, 259  
 Caño fijo 1/2", 199  
 Caño giratorio 1/2", 199  
 Caño giratorio de acero inoxidable, 259  
 Caño giratorio extra bajo, 260  
 Caño giratorio extra bajo 1/2", 199  
 Caño mural giratorio, 260  
 Caño negro de repuesto para grifo 464632, 277  
 Caño para válvula monomando dos aguas, 276  
 Cañón de ozono portátil 7.000 mg/h, 368  
 Caperuza porta-cenicero para papelera, 490  
 Carnicero, 118  
 Carro bandejero multinorma (Gastronorm / Euronorm / Pastelería), 324  
 Carro bañera para elevador, 323  
 Carro de lavado con desagüe en acero inoxidable, 323  
 Carro de limpieza, 404  
 Carro de limpieza multifunción con bolsa, plataforma y 3 bandejas, 405  
 Carro de manutención con ruedas y desagüe, 322  
 Carro de plataforma inox con asa retráctil, 325  
 Carro de recogida, 320  
 Carro de transporte, 325  
 Carro Euronorm, 324  
 Carro para canales, 327  
 Carro porta barriles de cerveza en acero inoxidable, 484  
 Carros de servicio, 319  
 Carros Gastronorm, 323  
 Cartelas abatibles para estantes murales, 52  
 Cartelas imagine, 28  
 Cartelas para estantes murales, 17  
 Cartucho de repuesto para grifos 464632 y 464633, 280  
 Cartucho para caño o válvula 1/4 de vuelta, 280  
 Cartucho para válvula, 281  
 Cartucho para válvula monomando, 279  
 Cartucho para válvula RD, 280  
 Cartuchos para modelos descatalogados, 281  
 Cascanueces, 169  
 Cazo, 140  
 Cazo para salsa en acero inox, 153  
 Cebollero, 117  
 Cenicero con soporte y depósito de arena, 490  
 Cenicero mural NF, 491  
 Cenicero papelera, 490  
 Cenicero para espacios reducidos, 491  
 Cenicero para espacios reducidos de pie, 491  
 Centro de reciclado 4 elementos, 389  
 Cepillo + palo polipropileno alimentario, 405  
 Cepillo cerdas inox, 80

Cepillo de limpieza con mango orientable para hornos profesionales, 157  
 Cepillo de mano multiusos metal detectable, 406  
 Cepillo lavavasos, 234, 460  
 Cepillo limpiaúñas de uso personal, 427  
 Cepillo rascador de fibras, 80  
 Cepillos para limpieza de manos y uñas, 427  
 Cerradura, 351, 375, 489  
 Cerradura con cadena para consigna de carros, 351, 489  
 Cerradura de retorno de monedas, 346, 348, 349, 351, 489  
 Cerradura electrónica para taquilla, 346, 348, 349, 351, 489  
 Cerradura maestra, 346, 348, 351, 489  
 Cesta alimentaria ligera, 456  
 Cesta alimentaria plegable, 456  
 Cesta de la compra supermercado apilable 60 litros con ruedas, 458  
 Cesta de lavavajillas para bandejas Euronorm o Gastro-norm, 459  
 Cesta de supermercado sencilla, 457  
 Cesta especial platos para lavavajillas, 459  
 Cesta especial vasos para lavavajillas, 459  
 Cesta expositora de rejilla circular 3 niveles, 469  
 Cesta expositora de rejilla rectangular, 469  
 Cesta rectangular, 166  
 Cesta redonda, 167  
 Cesta simple para lavavajillas, 458  
 Cestas alimentarias, 456  
 Cestillo de plástico para cubiertos, 460  
 Chaira cerámica, 133  
 Chaira diamantada, 134  
 Chairas, 133  
 Champanera acero inox, 174  
 Chuleteros, 89  
 Cierra bolsas inox, 471  
 Cinta antideslizante adhesiva amarillo/negro, 404  
 Cinta mural extensible de señalización, 477  
 Cocina, 126  
 Cocina alveolado, 116  
 Cocinero, 124  
 Cocinero , 125  
 Cocinero forjado, 115  
 Coctelera, 173  
 Codo a 90° M-H de 1/2", 202  
 Colador, 141  
 Colador/Tamizador, 141  
 Columna con dispensador de gel hidroalcohólico especial para niños, 416  
 Columna con dosificador de gel hidroalcohólico de funcionamiento a codo, 416  
 Columna de acero inoxidable para dispensadores, 478  
 Columna inox de desinfección para gel hidroalcohólico, 414  
 Columna inoxidable con dispensador "Su turno", 478  
 Columna mixta para guantes y botella de gel hidroalcohólico, 415  
 Columna mixta para guantes y dispensador electrónico de gel hidroalcohólico, 414  
 Columna para botella de gel hidroalcohólico, 415  
 Columna para botella de gel hidroalcohólico especial para niños, 416  
 Columna señalización con cinta, 477  
 Columnas para tubo de 38 mm, 42  
 Columnas perforadas para pletina, 40  
 Conector rápido universal H1/2", 268  
 Conjunto aros de emplatador, 85, 144  
 Conjunto de 6 aros de emplatador en acero inox, 144  
 Conjunto de conos para relleno de crema en acero inox, 159  
 Conjunto de ducha y pulsador profesional, 272  
 Conjunto de ducha, grifo monomando y mástil, 271  
 Conjunto dispensador de 3 salsas con dosificadores y soporte, 149  
 Conjunto dispensador de guantes y bolsas colgantes, 395  
 Conjunto dispensador de guantes y bolsas en rollo, 395  
 Conjunto lavamanos y fregadero mural, 194  
 Conjunto lavamanos y fregadero mural XS, 194  
 Conjunto peto, jabonera electrónica y dispensador tissues para lavamanos autónomo, 192  
 Conjunto rompe marisco, 163  
 Conjunto sal y pimienta, 169  
 Conjunto sujeción inferior para válvula 462406, 276  
 Conjunto sujeción inferior válvula de un agua, 275  
 Conjunto sujeción inferior válvula dos aguas, 276  
 Conjunto sujeción inferior válvula monomando dos aguas, 275  
 Conjuntos dispensadores de guantes y bolsas con pape-  
 leras, 396  
 Cono recoge grasas antigoteo para jamón, 108  
 Consigna mural para carros, 488  
 Consigna para carros, 488  
 Consigna para carros con taquilla, 488  
 Consumibles para dispensadores, 400  
 Contenedor de desperdicios, 386  
 Contenedor de desperdicios 80L serie GO, 390  
 Contenedor de desperdicios 95 lts, 311, 388  
 Contenedor de desperdicios con tapa y ruedas, 385  
 Contenedor de desperdicios y reciclaje, 300, 301, 389  
 Contenedor de plástico con tapa 55 litros, 311, 388, 393  
 Contenedor de reciclaje vertical, 391  
 Contenedor Gastronorm aislamiento térmico, 177, 453  
 Contenedor higiénico sanitario con apertura a pedal, 393  
 Contenedor inox para vaciado de bandejas de comida  
 rápida fast-food, 311, 388  
 Contenedor inoxidable con tapa, 386  
 Contenedor inoxidable con tapa de apertura a pedal, 386  
 Contenedor inoxidable con tapa y ruedas especial pana-  
 dería, 387  
 Contenedor isotérmico Euronorm 82 L., 177, 453  
 Contenedor isotérmico para bebidas con dispensador, 454  
 Contenedor para hielo, 322  
 Contenedor para reciclado, 390  
 Contenedor para transporte de cuchillos, 137  
 Contenedor para transporte de cuchillos con ruedas, 137  
 Contenedor para transporte de hielo, 322  
 Contenedor porta-bolsas con tapa y ruedas, 386  
 Contenedor porta-bolsas sistema "tijera", apertura a pedal, 387  
 Copa en policarbonato, 167  
 Copa helado, 434  
 Corta mariscos forjado, 169  
 Cortador de pizza, 156  
 Cortador de pizza profesional, 156  
 Cortadora de fiambres manual, 148  
 Cortadora de masa de pizza, 154  
 Cortar pan, 123  
 Cortina de lamas de PVC, 484  
 Cortina de ozono especial pescaderías, 369  
 Cronómetro de cocina, 364  
 Cruces para tubo, 60  
 Cubertero, 461  
 Cubertero plástico gris GN 1/1, 461  
 Cubetas Gastronorm alta temperatura, 440  
 Cubetas Gastronorm copoliéster, 438  
 Cubetas Gastronorm lisas, 435  
 Cubetas Gastronorm lisas., 81  
 Cubetas Gastronorm perforadas, 436  
 Cubetas GN para identificación de alérgenos, 441  
 Cubetas para helado, 432  
 Cubierta basculante para cubetas Gastronorm 1/1, 467  
 Cubierta protectora para mostrador de pescadería, 330  
 Cubitera con tapa de acero inox, 174  
 Cubo de acero inoxidable con tapa 15L serie GO, 408  
 Cubo industrial asa de acero inoxidable, 407  
 Cubo pedal baño con papelera interior, 394  
 Cubo plástico con asa metálica para fregar, 407  
 Cubos premium de acero inox, 408  
 Cobre aperitivos BC, 466  
 Cuchara de mesa, 168  
 Cucharón de servir, 140  
 Cuchilla de golpe, 91  
 Cuchillas de repuesto para afilador 448304 Juego de 4  
 cuchillas, 2 gomas protectoras grandes (63x48 mm.) y 1  
 goma protectora pequeña (45x20 mm.), 134

Cuchillería forjada, 115  
Cuchillo antioxidante para verduras, 122  
Cuchillo cocinero con filo dentado, 121  
Cuchillo cortador de tajadas de sandía o melón, 130  
Cuchillo de mesa corte liso, 168  
Cuchillo de mesa modelo chuletero, 168  
Cuchillo de mesa modelo chuletón, 168  
Cuchillo especial alimentos congelados, 123  
Cuchillo especial queso Emmental, 98  
Cuchillo especial queso Feta, 98  
Cuchillo especial queso lama perforada, 97  
Cuchillo especial queso Parmesano, 98  
Cuchillo especial queso Pavia, 97

## D

Decorador, 129  
Decorador de fruta, 129  
Defensa de esquina tubular 90°, 58  
Deglon Meeting 3 piezas, 119  
Delantal de escay, 355  
Delantal de protección en malla de acero inoxidable, 355  
Desagüe de poliamida blanca 3/4" L=90 mm., 332  
Desagüe flexible para lavamanos autónomo 1 1/2", 200  
Descorazonador, 129  
Deshuesador, 124  
Deshuesar, 118  
Deshuesar Carne, 91  
Deshuesar forjado, 116  
Deshuesar jamón, 111  
Deshuesar jamón curvo, 111  
Deshuesar jamón forjado, 110  
Desollar, 92  
Despellejar, 118  
Detalles, 41  
Detector de anisakis, 114  
Discos de respuesto para máquina de hacer churros y pastas, 160  
Dispensador de bobina industrial, 426  
Dispensador de bolsas, 395  
Dispensador de bolsas colgantes, 397  
Dispensador de bolsas en rollo, 397  
Dispensador de bolsas para envasado de alimentos, 398  
Dispensador de bolsitas higiénicas, 425  
Dispensador de gel hidroalcohólico automático de columna, 414  
Dispensador de gel hidroalcohólico automático en acero inox, 418  
Dispensador de gel hidroalcohólico de gran capacidad a pedal, 418  
Dispensador de guantes, 397  
Dispensador de mascarillas FFP2, 400  
Dispensador de papel higiénico modelo Nube, 425  
Dispensador de papel higiénico tripe en acero inoxidable, 423  
Dispensador de papel mecha, 426

## E

Elevador inox de fondo de fregaderos, 231  
Elevador inox para cesta de supermercado, 458  
Embellecedor para tocho, 65  
Embudo, 149  
Emplazamiento publicitario opcional para columna, 417  
Enchufe con mando a distancia, 374, 384  
Enfriador de agua, 212, 233  
Enjuagador de vasos y jarras a presión para fregadero, 234, 460  
Enrollador de maki higiénico, 86  
Enrollador de maki super-higiénico, 145  
Entrepaño para carro de servicio de 1.000x500 mm., 321  
Entrepaño para carro de servicio de 1.200x500 mm., 321  
Entrepaño para carro de servicio de 800x500 mm., 321  
Envasadora al vacío, 470  
Envase take away / delivery rectangular con tapa, 178  
Envase take away / delivery redondo con tapa, 178  
Envolvedora de sobremesa, 471

Cuchillo especial queso tierno, 97  
Cuchillo francés inyectado Adherent+, 91, 120  
Cuchillo panero de hoja ancha, 123  
Cuchillo panero de mango elevado y filo ondulado, 123  
Cuchillo panero especial pizza, 123  
Cuchillo pelador, 122  
Cuchillo todos usos, 90, 121  
Cuelga copas, 463  
Cuelga copas y tazas en varilla, 463  
Cuencos, 162  
Cuencos para salsas, 162  
Cutter combi (Metal detectable), 484

Dispensador de papel mecha acoplado a columna, 417  
Dispensador de papel mecha en acero inox, 426  
Dispensador de papel mini-mecha modelo Nube, 425  
Dispensador de rollos de papel higiénico, 423  
Dispensador de rollos de papel higiénico inoxidable, 423  
Dispensador de salsa con dosificador, 149  
Dispensador de tickets su turno, 477  
Dispensador de tissues, guantes, toallas, etc., 400  
Dispensador de toallas, 424  
Dispensador de toallas de papel con autocorte, 424  
Dispensador de toallas modelo Nube, 425  
Dispensador de vasos, 316, 463  
Dispensador de vasos universal, 464  
Dispensador en acero inoxidable de toallas de papel, 424  
Dispensador inox hexagonal de papel higiénico 400 m, 424  
Dispensador inox para cepillos de limpieza de manos y uñas, 427  
Dispensador mural de bobina industrial, 426  
Dispensador mural de papel alimentario, 398  
Dispositivo para abrir puertas anti-contagio, 429  
Doble fondo para cubeta gastronorm, 437  
Dosificador automático de gel hidroalcohólico con soporte de sobremesa, 420  
Dosificador de gel-espuma, 420  
Dosificador de jabón, 419  
Dosificador de jabón encastrable 600 ml., 202  
Dosificador de jabón inox, 420  
Dosificador de jabón inox encastrable, 421  
Dosificador de jabón modelo Nube, 419  
Dosificador de salsas - 30 ml., 151  
Dosificador de salsas y recipiente inox, 150  
Ducha de gran alcance H de 1/2", 263  
Ducha higiénica con llave de paso, 272  
Ducha higiénica serie basic, 273  
Ducha horno enrollable bajo encimera, 264  
Ducha horno enrollable H de 1/2", 264  
Ducha horno H de 1/2", 263  
Ducha mural de emergencia, 403  
Ducha para horno pulsador, 264

Equilibrador, 268, 478  
Escalones inox, 479  
Escalones para vitrinas, 464  
Escamador, 112  
Escamador EC, 113  
Escanciador de vino, 172  
Escoba haragán para empujar agua, con mango ergonómico, 405  
Escurridor de ollas regulable, 142  
Escurridor de platos y vasos en acero inoxidable, 146, 220  
Escurridor de verduras, 142  
Escurridor inox para cubetas Gastronorm, 445  
Escurridor mural para utensilios de cocina, 145, 220  
Escurridor para fibras de corte, 80  
Espátula de silicona y acero inox, 159  
Espátula para planchas de cromo-duro, 152  
Espátula para preparación pizza en acero inox, 156  
Espátula pastelera, 159  
Espátula plástica, metal detectable, 405



Espátulas, 140  
Especiero inox con tres niveles, 145  
Espejo antivandálico acero inoxidable, 412  
Espejo Inox, 195  
Espigas macho para sacacorchos de pared 483416, 171  
Espumadera, 140  
Espumadera inoxidable con mango de plástico, 140  
Espumador eléctrico manual mini con soporte, 141  
Esquinar, 90  
Estación de higiene para wc con dispensador de papel y escobillero en acero inoxidable, 410  
Estante abatible de fibra para punto de venta portátil de jamones, 108, 305  
Estante especiero, 145  
Estante inox para almacenaje de vino, 36  
Estante mural de fibra abatible, 18  
Estante mural especial microondas, 14  
Estante mural inclinado para cestas de lavavajillas, 18  
Estante mural porta-barquetas, 18  
Estantería con armario para botellas de zumo, 35  
Estantería gastronorm imagine, 24  
Estantería inox para almacenaje de vino, 36  
Estanterías de sobremesa, 21, 300, 313  
Estanterías gastronorm imagine a pared, 26  
Estanterías modulares con estantes lisos, 9  
Estanterías suspendidas, 20, 314  
Estantes de suelo, 17  
Estantes fibra imagine, 29  
Estantes inox imagine, 29  
Estantes lisos para estanterías modulares, 10  
Estantes murales, 16

## F

Felpudo higiénico de caucho, 429  
Fiambre, 96  
Fiambre dos mangos, 96  
Fiambra de cristal con tapa hermética, 446  
Fibra de colores intercambiables, 82  
Fibra para corte de pan, 83  
Fibra redonda de corte de polietileno de alta densidad P500, 77  
Fibras a medida, 77  
Fibras chuletón rectangulares, 163  
Fibras estándar, 75  
Fibras estándar 400x300x20, 81  
Fibras GN, 76  
Fibras por planchas, 79  
Fileteador flexible, 118  
Filetear, 117  
Fileteros, 89  
Filtro agua fría para Futura, Cold+ y Enfriador de agua, 214  
Filtro Bestmax para Futura fría y caliente, 214  
Filtro inoxidable para campana extractora industrial, 318  
Filtro profesional de agua Brita, 214  
Filtro repuesto HEPA 13, 366  
Fluxómetro para WC, 273  
Fondos perforados para cubetas Gastronorm copoliéster, 439  
Fondos perforados para recipientes de polipropileno, 442  
Forro isoterma interior para cajas de reparto / distribución, 176, 454  
Fregadero especial para escayolas, 232

## G

Gafas antiproyecciones, 359  
Gancho de arrastre, 49  
Gancho de varilla modelo " J ", 45  
Gancho de varilla multifunción, 47  
Gancho giratorio, 48  
Gancho pesador, 62  
Ganchos de varilla modelo " J ", 45  
Ganchos de varilla modelo " S ", 46  
Ganchos de varilla modelo " S ", 46  
Ganchos forjados, 44  
Ganchos jamoneros, 47

Estantes murales cartelas modelo compacto, 14  
Estantes murales con cartelas, 16  
Estantes murales de tubo, 14  
Estantes murales regulables imagine, 15  
Estárter para 15 W, 383  
Estárter para 30 W, 383  
Esterilizador de cuchillos mediante agua caliente para adosar, 370  
Esterilizador de cuchillos mediante ozono para adosar, 370  
Estropajo para tablas de corte, 81  
Europalet higiénico reforzado, 482  
Expositor central de grifería, 246  
Expositor de frutas y verduras inox con ruedas, 337  
Expositor mural de grifería, 246  
Expositor mural de grifería con grifos, 246  
Extensión cesta simple, 458  
Exterminador de insectos interior/exterior mediante parrilla eléctrica Serie LD120, 378  
Exterminador de insectos mediante parrilla eléctrica serie UK-INOX, 376  
Exterminador de insectos mediante trampa adhesiva serie BC, 379  
Exterminador de insectos mediante trampa adhesiva serie MR LED, 377  
Exterminador de insectos mediante trampa adhesiva serie UL, 376  
Exterminador de insectos mediante trampa adhesiva Serie V30, 378  
Exterminador de insectos serie SP-80 LED, 377  
Extra-short table shower fitting support, 274

Fregadero para bicicletas XL, 232  
Fregadero vertedero, 231  
Fregaderos, 218, 219  
Fregaderos colgantes con cartelas, 224  
Fregaderos colgantes con faldón o palomilla de doble seno, 227  
Fregaderos colgantes con faldón o palomillas, 226  
Fregaderos con puertas de corredera y abatibles, 228, 229  
Fregaderos con soporte, 222, 223  
Fregaderos para encastrar, 217  
Fregaderos para lavavasos y lavaplatos, 221  
Fregaderos para soldar, 217  
Fregaderos portátiles, 230  
Fregaderos soldados a mesas, 317  
Fregona profesional con tiras de microfibra y casquillo Pro, 407  
Frontal curvado transparente de 963 mm., 332  
Fuente de agua fría Cold+, 206  
Fuente de agua fría Cold+ mural, 206  
Fuente de agua fría de columna, 207  
Fuente de agua fría de columna con grifo electrónico sin contacto, 207  
Fuentes de agua fría, caliente y del tiempo Futura, 205  
Fuentes de columna sin refrigeración, 210  
Fuentes murales refrigeradas de agua fría Cold+ a pedal, 208  
Fuentes murales sin refrigeración, 211  
Fuentes refrigeradas de agua fría Cold+ a pedal, 209  
Funda antivibradora para taco regulable, 499  
Funda reutilizable para carro de pastelería Euronorm, 325

Ganchos salchicheros, 48  
Garras galvanizadas para tirantes, 56  
Gaveta expositora, 468  
Generadores de ozono inyectado para interior de cámaras frigoríficas, 367  
Goma de repuesto para contenedor porta-bolsas, 393  
Goma elástica para la sujeción de bolsas de basura en lavamanos, 201  
Grifería, 241  
Grifo Clinic Expert, 258  
Grifo cocina monomando sobremesa cuello de cisne de

acero inoxidable, 247  
Grifo cocina monomando sobremesa de acero inoxidable, 247  
Grifo cocina sobremesa doble función de acero inoxidable, 252  
Grifo columna sobremesa 2 aguas pomo aislante, 256  
Grifo de cocina efecto granito, 250  
Grifo de cocina inteligente contactless con selector de temperatura, 258  
Grifo de columna orientable sobremesa 2 aguas monomando, 257  
Grifo de columna orientable sobremesa de un agua, 256  
Grifo de columna orientable sobremesa pomo aislante, 255  
Grifo de palanca un agua M-M de 1/2", 198  
Grifo de sobremesa dos aguas con pomo aislante, 255  
Grifo de sobremesa electrónico, 259  
Grifo ducha monomando sobremesa dos aguas serie doméstico, 248  
Grifo ducha sobremesa serie doméstico con piña, 247  
Grifo electrónico inoxidable a pilas para fuente de agua 1/2", 214, 262  
Grifo electrónico temporizado para urinario. Funcionamiento a pilas, 273  
Grifo giratorio extrabajo dos aguas, 252  
Grifo giratorio extrabajo un agua, 252  
Grifo giratorio sobremesa 1/4 vuelta un agua caño bajo, 253  
Grifo giratorio sobremesa dos aguas 1/4 de vuelta caño bajo, 252  
Grifo giratorio sobremesa dos aguas serie 1/4 de vuelta, 251  
Grifo giratorio sobremesa dos aguas serie extra bajo, 253  
Grifo llenajarras, 263  
Grifo llena-jarras, 214  
Grifo llenajarras de acero inoxidable, 263  
Grifo llenajarras electrónico acero inoxidable para fuente de agua, 214, 263  
Grifo manguera 50 m. con soporte inox y pistola, 265  
Grifo manguera enrollable inoxidable serie compacto, 266  
Grifo manguera enrollable serie básico, 267  
Grifo manguera enrollable serie inoxidable, 267  
Grifo manguera enrollable serie profesional, 265  
Grifo manguera enrollable serie profesional plus, 266  
Grifo mezclador sobremesa con mandos 1/4 de vuelta, 251  
Grifo monoblock electrónico con selector de temperatura. Funcionamiento a pilas, 258  
Grifo monomando mural de codo dos aguas serie monoblock-bajo, 254  
Grifo monomando mural de codo dos aguas serie monoblock-elevado, 254  
Grifo monomando mural de codo para dos aguas, 254  
Grifo monomando para baño/ducha serie Ecológica, 271  
Grifo monomando para bidé serie Ecológica, 270  
Grifo monomando para ducha serie Ecológica, 271  
Grifo monomando para lavabo serie Ecológica, 269  
Grifo monomando sobremesa caño alto para fregadero, 248

## H

Hacer agujero de desbarasado a estantes imagine, 29  
Hacer agujero en fregadero o lavamanos, 201, 235  
Hacha de bombero con mango de fibra, 430  
Hacha de cámara con mango de fibra, 430

## I

Indicador de suelo mojado, 404  
Interruptor luminoso On/Off, 375

## J

Jabonera, 411  
Jabonera electrónica (funcionamiento a pilas), 420  
Jamón serrano, 109  
Jamón serrano alveolado punta redonda, 110  
Jamón serrano punta redonda, 110  
Jamón serrano virola, 109  
Jamonero antiadherente, 125  
Jamonero giratorio basculante RT-3D, 102  
Jamonero giratorio mural RT-2D, 102

Grifo monomando sobremesa caño giratorio elevado, 249  
Grifo monomando sobremesa con caño bajo, 253  
Grifo monomando sobremesa de codo dos aguas, 249  
Grifo monomando sobremesa de codo dos aguas serie monoblock, 249  
Grifo monomando sobremesa de codo dos aguas serie monoblock-elevado, 250  
Grifo monomando sobremesa de codo elevado, 251  
Grifo monomando sobremesa de columna, 256  
Grifo monomando sobremesa dos aguas caño frontal, 250  
Grifo monomando sobremesa extensible de codo, 248  
Grifo monomando sobremesa extensible de codo leva larga, 248  
Grifo monomando sobremesa giratorio dos aguas, 249  
Grifo monomando sobremesa para fregadero serie Ecológica, 250  
Grifo mural de 1 agua con pomo aislante caño alto, 255  
Grifo mural de 1 agua con pomo aislante caño bajo, 255  
Grifo mural de codo un agua, 254  
Grifo mural dos aguas 1/4 de vuelta caño bajo, 253  
Grifo mural dos aguas cuarto de vuelta, 253  
Grifo mural electrónico. Funcionamiento a pilas, 259  
Grifo para fuente de agua sin pulsador, 214, 262  
Grifo para lavabo de 1 agua, 269  
Grifo pulsador para fuente, 214, 262  
Grifo sobremesa de un agua serie 1/4 de vuelta, 247  
Grifo sobremesa electrónico, 199  
Grifo sobremesa electrónico de acero inoxidable, 259  
Grifo temporizado dos aguas, 270  
Grifo temporizado para urinario, 273  
Grifo temporizado un agua, 270  
Grifos ducha de sobremesa, 242  
Grifos ducha de sobremesa extra bajos, 244  
Grifos ducha de sobremesa monomando, 243  
Grifos ducha murales, 245  
Grifos giratorios sobremesa dos aguas, 251  
Guante de cinco dedos ambidiestro en malla de acero inoxidable, 354  
Guantes alimentarios anticorte, 355  
Guantes anticalóricos hasta 100°C, 356  
Guantes anticorte industrial, 357  
Guantes anti-salpicaduras aceite hirviendo, 356  
Guantes de nitrilo escamados talla L (caja 50 ud.), 358  
Guantes de nitrilo para uso alimentario, 358  
Guantes de piel industrial, 358  
Guantes de protección química, 358  
Guantes para frío extremo en piel, 357  
Guantes para frío extremo en PVC hasta -20°C, 357  
Guantes para pescadero, 356  
Guardavivos exterior de acero inoxidable, 487  
Guardavivos interior de acero inoxidable, 487  
Gubia deshuesar jamón, 110

Hoja de repuesto inox., 93  
Hojas de repuesto en acero inoxidable para espátula plancha de cromoduro., 152

Isla de cocina inox con encimera de granito, 303  
Isla de cocina inox con encimera de madera de pino, 303

Jamonero giratorio RT-2D, 102  
Jamonero para adosar a tajo con madera, 74, 104  
Jamonero titanio, 124  
Jamonero Zwilling, 117  
Jarra de agua, 167  
Jarra medidora con fondo antideslizante 1 L, 160  
Jarra medidora de cristal 1 L., 160  
Juego de 4 esponjas de colores, 406  
Juego de café de 5 piezas para 6 tazas, 175



Juego de cuchillas de repuesto paracepillo rascador., 80  
Juego de cuchillas de repuesto., 484  
Juego de dos tapones de repuesto para bomba vacío, 172  
Juego de herrajes para puertas (para 2 puertas), 489  
Juego de juntas para el mástil del grifo ducha, 275  
Juego de juntas para grifo manguera serie profesional 8 m., 282

## K

Kit de conexión a red de agua para lavamanos autónomo, 192  
Kit de acoplamiento a rueda, 497  
Kit de acoplamiento de rueda a bastidor de carros de servicio, 321  
Kit de fijación para estanterías de sobremesa, 21, 313  
Kit de juntas para pulsador no temporizado 460404, 198  
Kit de juntas para pulsador temporizado, 278  
Kit de pletinas para estanterías, 11

## L

Laminador de tartas, 158  
Lámpara de 15 W., 375  
Lámpara de 30 W., 375  
Lámpara para calentar platos, 315  
Lámpara UV-C 2 pines 10 W., 366  
Lanza rociadora M 1/2", 282  
Largueros inferiores imagine, 27  
Largueros superiores imagine, 28  
Lateral transparente, 332  
Latiguillo de repuesto para grifo 463052, 274  
Latiguillo de repuesto para grifo 463220, 274  
Latiguillo de repuesto para grifo doméstico 463050, 278  
Latiguillo inferior para grifo ducha dos aguas, 276  
Latiguillo inox. plastificado para grifo ducha, 274  
Latiguillo lastrado para grifo monomando ducha extensible, 278  
Latiguillo para ducha horno 2000 mm H-H 1/2", 282  
Latiguillo para ducha horno enrollable 463006 y 463008, 282  
Latiguillos flexibles en malla de acero inoxidable H-H de 1/2", 200, 274  
Latiguillo para ducha de gran alcance 2000 mm H-H 1/2", 282  
Lavabotas manual en acero inoxidable, 403  
Lavamanos autónomos, 190

## M

Mampara de protección de sobremesa, 428  
Mampara de protección para colgar, 428  
Mando inalámbrico de repuesto, 477  
Mandolina para cortar / laminar trufas en acero inoxidable, 148  
Mango de repuesto para serrucho, 93  
Manguera de repuesto 12 m. para grifo manguera serie profesional, 282  
Manguera de repuesto 15 m. para grifo manguera serie inox., 282  
Manguera de repuesto 8 m para grifo de manguera serie profesional, 282  
Manguera flexible de 1", 332  
Manoplas anticalóricas hasta 250°C, 356  
Manoplas anticalóricas hasta 500°C, 357  
Máquina para hacer churros y pastas, 160  
Máquina termoselladora para bolsas de 400 mm., 472  
Marquesina para puertas, 485  
Mástil con caño para grifo ducha, 275  
Mástil extra corto para grifo ducha, 274  
Mástil para grifo ducha, 274  
Mazo de picar, 84  
Mazo para chino, 85, 142  
Medidor de compuestos polares / calidad del aceite de fritura, 364  
Medidor de PH, 365  
Mesa / Carro auxiliar multifuncional para instrumental o de servicio con ruedas, 320  
Mesa barman, 301  
Mesa central con dos entrepaños. Especial cortadoras de fiambre, 296  
Mesa central con dos entrepaños. Especial cortadoras de

Juego de llaveros numerados del 1 al 6, 351, 489  
Juego de muelle y juntas para piña de grifo ducha, 274  
Juego de placas numeradas del 1 al 6, 351, 489  
Juego válvulas antirretorno para grifo monomando dos aguas, 278

Kit de útiles para barbacoa, 131  
Kit golpeador para cajón modular, 313  
Kit golpeador para cajón pequeño, 495  
Kit para colgar utensilios, 49, 106, 300  
Kit para colgar utensilios imagine, 30  
Kit portarrollos insonorizado para papel o film, 399  
Kits de portarrollos de papel o film, 399  
Kits de portarrollos de papel o film serie Eco, 106, 399

Lavamanos electrónico 3D, 193  
Lavamanos mural colectivo, 195  
Lavamanos mural colectivo de rodilla agua fría y caliente, 195  
Lavamanos murales, 184  
Lavamanos murales electrónicos, 187  
Lavamanos quirúrgico con grifos mixtos, 197  
Lavamanos quirúrgico doble con grifos electrónicos, 197  
Lavamanos quirúrgico mural con grifería, 196  
Lavamanos registrables de agua fría y caliente, 182  
Lavamanos registrables electrónicos, 186  
Lavaojos mural de emergencia en acero inoxidable, 403  
Lavaporcionador de helados mural, 433  
Lavaporcionador de helados para encastrar, 433  
Lenguado, 121  
Leva de repuesto para grifo monomando sobremesa 463242, 276  
Librador , 142  
Limpiador de acero inoxidable, 500  
Lira para cortar queso, 98  
Llave maestra para cerraduras, 346, 348, 349, 351, 489  
Losetas antideslizantes, 480  
Lower fixing set for single inlet valve, 275

fiambre con reborde de seguridad, 297  
Mesa central con entrepaño especial maquinaria - Altura estándar, 298  
Mesa central con entrepaño. Especial maquinaria, 298  
Mesa central con estantes de sobremesa sistema imagine, 34  
Mesa central con ruedas y 2 entrepaños, 297  
Mesa central de emplatado imagine, 32  
Mesa central inox con encimera de cristal translúcido, 303  
Mesa de preparación de verduras, 291  
Mesa de terraza, 300  
Mesa jamonera RT-2D, 105, 305  
Mesa jamonera RT-3D, 106, 305  
Mesa mural con cartelas, 289  
Mesa mural con estantes sobremesa serie imagine, 33  
Mesa mural con puertas y sistema de elevación eléctrico, 299  
Mesa mural de prelavado, 293  
Mesa mural desbarasado con fregadero, 290  
Mesa mural desbarasado con puerta, 291  
Mesa mural desbarasado y reciclaje con puerta, 389  
Mesa mural inox con sistema de elevación, 299  
Mesa mural sotabanco con dos entrepaños, 296  
Mesa para cocción de marisco, 335  
Mesa para maquinaria con sistema de elevación, 298  
Mesa para marisco, 335  
Mesa-bastidor para horno, 295  
Mesas centrales, 287  
Mesas centrales con reborde y desagüe, 309  
Mesas centrales encimera de polietileno, 306  
Mesas de despiece, 310  
Mesas de entrada / salida de lavavajillas, 294

Mesas de preparación centrales, 307  
Mesas de preparación murales, 308  
Mesas de preparación y lavado, 292, 333  
Mesas murales, 287  
Mesas murales a pared, 288  
Mesas murales con puertas, 288  
Mesas murales con puertas y cajones, 289  
Mesas murales con reborde y desagüe, 309  
Mesas murales de cajones, 295  
Mesas murales de Chef, 290  
Mesas plegables con entrepaño, 296  
Mezclador antiretorno M-H-M 1/2", 202  
Modelo cocina, 120  
Molde para laminar tartas 24/30 cms., 158  
Moldes cuadrados, 144  
Molinillo 2 en 1 sal y pimienta, 146  
Molinillo de hierbas, 146  
Molinillo juliana, 147  
Monitor de calidad del aire detector de CO2, 366

## O

Opción de kit de ozono acoplado., 344, 345, 346, 348, 349  
Oxigenador de vino, 172

## P

Pack de 6 colores de repuesto, 82  
Pala cuadrada de aluminio para horno, 155  
Pala de acero inoxidable y polietileno, 84  
Pala de mano para hielo, 336, 466  
Pala inox para loncheado de embutidos, 99  
Pala inox para servir tarta, 159  
Pala inoxidable para patatas fritas con dos asas, 150  
Pala para hielo, 336, 465  
Pala para hielo en acero inox, 173  
Pala para pizza, 155  
Pala para tartas / pizza en acero inox, 160  
Pala redonda de aluminio para horno, 155  
Palanca para válvula monomando dos aguas, 276  
Palanca repuesto para válvulas 462412, 462408, 463206, 276  
Palanca un agua M-M 1/2", 261  
Palet encajable de plástico liso, 481  
Palet encajable enrejado, 481  
Palet para embutidos, 327  
Palet para jamones, 326  
Paleta, 140  
Paleta de fibra para aplastar hielo, 336  
Paleta oval en acero inox, 155  
Paleta oval en acero inox perforada, 155  
Paleta para servir pizza en acero inox, 156  
Paleta redonda aluminio, 156  
Paletas y espátulas, 127  
Panel medidor de CO2 monitor de calidad del aire mural / sobremesa, 365  
Panero cerámico, 126  
Panero con revestimiento antiadherente, 125  
Panero de titanio, 124  
Panero forjado, 116  
Pantalla antiproyecciones, 359  
Papeleras, 200, 394  
Papeleras acopladas, 417  
Papeleras basculante en acero inoxidable, 392  
Papeleras con tapa y pedal, 394  
Papeleras con tapa y ruedas 70 lt, 387  
Papeleras de plástico con pedal, 393  
Papeleras de reciclaje, 390  
Papeleras inox de 70 lt apertura frontal, 392  
Papeleras modelo Design, 394  
Papeleras modelo Design (lavamanos integral mural), 200  
Papeleras su turno para mostrador, 341  
Papeleras su turno para mostrador de pescadería, 331  
Papeleras-dispensador de bolsas de papel, 398  
Papeleras-dispensador de papel, 200  
Parachoques para carros de servicio, 321  
Paragüero inox, 472

Monomando baño/ducha, 271  
Monomando bidé, 269  
Monomando ducha, 270  
Monomando lavabo, 269  
Montaje cerradura electrónica en puerta de taquilla (no incluye cerradura), 351, 489  
Montaje de la cerradura de retorno de monedas (no incluye cerradura), 351, 489  
Mortero, 85  
Mortero de acero inox, 141  
Mostrador de pescadería, 329  
Mostrador de pescadería con soporte, 328, 330  
Mostrador frutería, 338, 340  
Mostrador frutería sobre obra, 339  
Mueble cafetero inox basic, 302  
Mueble cafetero inox doble, 302  
Muelle elevación de palanca, 95  
Muelle para grifo ducha, 274

Ozonizador de agua, 368

Pareja de muelles, 95  
Parking para carros de la compra, 59  
Parking para mascotas en acero inoxidable, 471  
Parking soporte para aparcamiento de bicicletas en acero inoxidable, 472  
Pasacable azul Ø 36x2,5 mm., 332  
Pasacable inox, 499  
Pasapuré profesional, 147  
Pedal de un agua M-M de 1/2", 198  
Pedal de un agua M-M de 1/2", 261  
Pedal mezclador de agua fría y caliente con palanca de bloqueo H-H-H- 1/2", 260  
Pedal mezclador de agua fría y caliente M-M-M de 1/2", 198  
Pedal mezclador de agua fría y caliente M-M-M de 1/2", 261  
Pedal opcional, 392  
Pedal opcional 120 lts, 385  
Pedal opcional 240 lts, 385  
Pedal opcional 60 lts, 385  
Pelador, 128  
Pelador de cerámica, 126, 143  
Pelador de espárragos, 128  
Pelador forjado, 116  
Pelar patas, 92  
Percha industrial de acero inoxidable, 350, 473  
Perchero, 473  
Perchero individual, 412  
Perchero mural de acero inoxidable, 473  
Perfil paragolpes ángulo exterior de fibra blanca, 486  
Perfil paragolpes ángulo interior de fibra blanca, 486  
Perfil paragolpes curvo mural de plástico, 487  
Perfil paragolpes recto de fibra blanca, 486  
Perfiles divisorios para cubetas Gastronorm, 444  
Pescadero, 112  
Peto lateral reversible para mesas, 317  
Peto postizo con taladros, 199  
Peto postizo de esquina, 199  
Peto postizo envolvente anti salpicaduras, 199  
Peto postizo lateral reversible anti salpicaduras, 199  
Peto postizo para acoplar, 199  
Peto transparente imagine, 31  
Picador de masa de pizza en acero inox, 153  
Picador de tomate, 147  
Pictograma Ascencor, 474  
Pictograma Aseo Discapacitados, 474  
Pictograma Aseo familiar, 474  
Pictograma Aseo Hombre, 474  
Pictograma Aseo Mujer, 474  
Pictograma Aseo unisex, 474  
Pictograma Botiquín, 474

Pictograma Cafetería, 475  
 Pictograma Cambia-Bebes, 474  
 Pictograma Carros, 475  
 Pictograma Desinfección de calzado, 476  
 Pictograma Dirección, 475  
 Pictograma Distancia de seguridad, 476  
 Pictograma Duchas, 474  
 Pictograma Espere tras la línea, 476  
 Pictograma Guantes, 476  
 Pictograma Información, 475  
 Pictograma Mascarilla, 475  
 Pictograma Número 0, 476  
 Pictograma Número 1, 476  
 Pictograma Número 2, 476  
 Pictograma Número 3, 476  
 Pictograma Número 4, 476  
 Pictograma Número 5, 476  
 Pictograma Número 6, 476  
 Pictograma Número 7, 476  
 Pictograma Número 8, 476  
 Pictograma Número 9, 476  
 Pictograma Parking, 475  
 Pictograma Permitido fumar, 475  
 Pictograma Prohibido, 475  
 Pictograma Prohibido animales, 475  
 Pictograma Prohibido el paso, 475  
 Pictograma Prohibido el uso de teléfono, 475  
 Pictograma Prohibido fumar, 475  
 Pictograma Puesto de gel hidroalcohólico, 476  
 Pictograma Restaurante, 475  
 Pictograma Tercera edad, 474  
 Pictograma Termómetro, 476  
 Pictograma Uso obligatorio de mascarilla, 475  
 Pictograma Vestuario/Guardarropa, 474  
 Pictograma WC, 475  
 Pictograma Zona Wifi, 475  
 Pictogramas en acero inoxidable, 474  
 Pie de champanera, 174  
 Pie inox para lavamanos mural colectivo, 196  
 Pie regulable inox de Ø 63,5x150 mm., 332  
 Piedra de afilar de mano, 134  
 Piedra para afilar cuchillos al agua 240/320, 134  
 Pies centrales imagine, 27  
 Pies murales imagine, 27  
 Pincel de silicona y acero inox, 158  
 Pincho antipalomas en acero inoxidable, 485  
 Pinchos brocheta, 161  
 Pinza de servir, 139  
 Pinza para bandeja de horno en acero inox, 153  
 Pinza para barbacoa, 139  
 Pinza para cubitos de hielo, 173  
 Pinza para frituras, 139  
 Pinza para servir espaguetis acero inox, 139  
 Pinzas para embutidos, 111  
 Piña de acero inoxidable para grifo ducha, 268, 274  
 Piña de repuesto para grifo de accionamiento extensible, 268, 274  
 Piña para ducha de gran alcance M 1/2", 282  
 Piña para ducha horno 463006, 282  
 Piña para ducha horno M 1/2", 282  
 Piña para grifo ducha, 268, 274  
 Piña para grifo ducha serie Ecológica, 268, 274  
 Piña para grifo monomando ducha extensible, 278  
 Pistola con lanza rociadora H 1/2", 268  
 Pistola para lanza de acero inoxidable H 1/2", 282  
 Pistola rociadora de pulverización regulable H 1/2", 268  
 Pizarra de led con atril, 468  
 Placa eutéctica GN 1/1 acumulador de frío de 0 a -21°C, 177, 453  
 Plafón para calentar platos, 315  
 Plafones para exposición de embutidos, 52, 108  
 Plaqueta, 59  
 Plaqueta redonda, 59  
 Plataforma con freno para transporte de cestos de lavavajillas, 482  
 Plataforma rodante, 482  
 Plato cuatro salsas, 164  
 Plato de cocktail, 164  
 Plato de presentación, 163  
 Plato de presentación especial pulpo, 163  
 Plato ducha inox, 411  
 Plato giratorio, 166  
 Plato giratorio de cristal, 165  
 Plato pizza, 163  
 Pletinas, 43  
 Pollero, 92  
 Pomo articulado, 351, 489  
 Pomo azul para válvula 462414 y 462416, 278  
 Pomo corto para válvula 462406, 277  
 Pomo de repuesto para mástil con caño, 275  
 Pomo rojo para válvula 462414 y 462416, 278  
 Porcionador automático de helado, 434  
 Porcionadores de helado, 433  
 Porta brochetas, 161  
 Portacuchillos con doble alojamiento de sobremesa, 137  
 Portacuchillos mural imantado, 138  
 Portacuchillos mural imantado de acero inoxidable, 138  
 Portacuchillos para adosar con envolvente, 74, 136  
 Portacuchillos para adosar con envolvente., 70  
 Portacuchillos portátil, 136  
 Portacuhillos inox portátil, 374  
 Portacuhillos para adosar en chapa, 74, 138  
 Portacuhillos para adosar en varilla, 74, 138  
 Portajamones, 103  
 Portalacones, 105  
 Porta-notas mural, 300, 313, 462  
 Portaprecios en varilla inox, 470  
 Portaprecios en varilla inox con pincho, 469  
 Porta-precios imagine, 31  
 Portarollos papel higiénico con repisa, 412  
 Portarollos dispensador de film para envolver, 399  
 Portarollos papel higiénico, 411  
 Prensa ajos, 146  
 Prolongación modular, 340  
 Prolongación modular para mostrador de pescadería, 329, 330  
 Protector auditivo, 359  
 Protector para picadora de carne, 95  
 Puerta, 495  
 Puerta rodante para contenedores, 316  
 Puesto de lavado y desinfección, 266, 413  
 Puesto pescadero encimera polietileno, 334  
 Puesto pescadero modelo sencillo, 334  
 Pulsador inoxidable temporizado M-M de 1/2", 198  
 Pulsador no temporizado M-M de 1/2", 198  
 Pulsador no temporizado M-M de 1/2", 261  
 Pulsador temporizado M-M de 1/2", 261  
 Puntilla con mango de madera, 93  
 Puntillas, 122  
 Puntilla, 126  
 Puntilla Zwilling, 117  
 Puntilla con revestimiento antiadherente, 125  
 Punto de venta portátil de jamones, 107, 304  
 Punzonador de embutidos, 148  
 Purificador de aire con filtro HEPA y lámpara UV hasta 60 m2, 366

## Q

Queseras base plástico, 468

## R

Rallador, 128

Queso, 97

Rallador de queso, 146



Rallador inox, 147  
 Rampa loseta, 481  
 Rasqueta cortadora de masa en acero inoxidable, 154  
 Rasqueta para vitrocerámicas, 152  
 Rebosadero (fregaderos serie 600 y 700 mm), 234  
 Rebosadero para lavamanos 061402, 061404 y 061448, 200  
 Recipientes de polipropileno, 442  
 Recoge verduras, 131  
 Recogedor con palo metálico, 407  
 Recogedor de mano inox, 406  
 Recogedor inox, 406  
 Recubrimiento modular para islas de congelación, 466  
 Reductor desagüe de 2" a 1 1/2", 235  
 Refuerzos soldados a estantes, 11  
 Registrador de temperatura y humedad, 363  
 Reglajes y resistencia imagine, 23  
 Rejilla de aluminio para hornear pizza, 154  
 Rejillas Gastronorm de acero inoxidable, 444  
 Relación de repuestos para exterminadores de insectos, 382  
 Remaches tubulares, 66  
 Remo, 84  
 Repisa, 412  
 Repuesto cuchilla para abrelatas industrial 440021, 144  
 Repuesto de cepillo de limpieza. Replacement cleaning brush., 157  
 Repuesto de fibras para mesas, 78  
 Repuesto de mazas, 73  
 Repuesto de mazas para acoplar fibra superpuesta, 73  
 Repuesto de muela (grano 60) para afilador 448306, 135  
 Repuesto de muela abrasiva (grano 120) para afilador 448306, 135  
 Repuesto de tirante a pared y soporte para piña para grifos 463080 y 463081, 275  
 Repuesto fibra para 041062, 137  
 Repuesto fibra para 041060, 137  
 Repuesto golpeador de posos de café, 495

## S

Sacacorcho navaja, 170  
 Sacacorcho Tirolés, 170  
 Sacacorchos mural, 171  
 Salmón Victorinox, 118  
 Salmón de titanio, 124  
 Salsera 8 salsas, 165  
 Salsera circular 6 salsas, 164  
 Salsera rectangular 4 salsas, 165  
 Salsera rectangular 6 salsas, 165  
 Salseras de diseño 6 salsas, 165  
 Salvamantel extensible, 169  
 Santoku, 122  
 Santoku de titanio, 124  
 Santoku cerámico, 126  
 Secamanos inox con pulsador y tobera, 421  
 Secamanos inox de bajo consumo, 422  
 Secamanos óptico en ABS, 422  
 Secamanos óptico en ABS sin tobera modelo Nube, 422  
 Secamanos óptico inox satinado con tobera, 421  
 Secamanos óptico inox satinado sin tobera, 421  
 Secamanos ultrarápido, 423  
 Separador de monedas y billetes, 461  
 Separador para mesa de marisco, 335  
 Separador para mostrador de frutería / pescadería, 339, 341  
 Separadores centrales, 41  
 Separadores de esquina, 41  
 Separadores para taquillas, 350  
 Serrucho acero inoxidable, 93  
 Set colgador sujeta-palos, 473  
 Set de 4 flaneras de ø8 cm, 144  
 Set de cepillo y soporte inoxidable para baño, 411  
 Set de decoración, 130  
 Set para corte de jamón, 109  
 Sifón de desagüe (fregaderos ancho 500 mm, lavamanos, gran capacidad), 235  
 Sifón de desagüe para lavamanos 1 1/2", 200

Repuesto roldana para abrelatas industrial 440021, 144  
 Repuestos fregaderos, 234, 235  
 Repuestos para aplasta hamburguesas, 95  
 Repuestos para carros de servicio y recogida, 321  
 Repuestos para contenedor de reciclaje vertical, 392  
 Repuestos para contenedores inoxidables, 393  
 Repuestos para esterilizadores, 375  
 Repuestos para exterminadores de insectos, 383, 384  
 Repuestos para grifos, 274  
 Repuestos para mostradores de pescadería, 332  
 Repuestos para purificador de aire, 366  
 Repuestos para serruchos, 93  
 Repuestos y accesorios para lavamanos, 198, 199, 200  
 Repuestos y complementos para mobiliario, 351  
 Repuestos y complementos para complementos, 489  
 Resistencia, 375  
 Resistencia de carga por estante, 12  
 Rizador de mantequilla, 128  
 Rociador de ducha, 272  
 Rodillo, 84  
 Rollo 2.000 tickets su-turno, 477  
 Rollo de 2m de bayeta posavasos antideslizante multiusos, 234, 460  
 Rueda anticalórica con freno en acero inoxidable ø100 mm, 324, 496  
 Rueda anticalórica con freno en acero inoxidable ø100 mm., 321  
 Rueda anticalórica en acero inoxidable ø100 mm., 321  
 Rueda anticalórica en acero inoxidable ø100 mm, 324, 496  
 Rueda de plástico ø50x18 mm para lavamanos autónomo, 201  
 Rueda de repuesto para taburetes., 19, 480  
 Rueda galvanizada con freno de diámetro 125 mm., 321  
 Rueda galvanizada sin freno de diámetro 125 mm., 321  
 Rueda repuesto para contenedores inox, 393  
 Ruedas, 496  
 Ruedas acopladas, 106, 497

Sifón de latón cromado, 235  
 Sifón de latón cromado 1 1/2", 201  
 Sifón de PVC acabado cromado, 235  
 Sifón de PVC acabado cromado 1 1/2", 201  
 Sistema filtrador de agua, 212  
 Sistema filtrador de agua con caño, 213  
 Sistema filtrador de agua con grifo llenajarras, 213  
 Soporte de sobremesa o mural para botella de gel hidroalcohólico, 415  
 Soporte de sobremesa y mural porta-cubetas Gastro-norm, 13  
 Soporte dispensador de bolsas de paraguas, 472  
 Soporte imagine, 28  
 Soporte imagine a pared, 28  
 Soporte inox para tacos o burritos, 164  
 Soporte jamón RT, 60, 103  
 Soporte organizador de acero inoxidable para 3 salsas, 150  
 Soporte para cafeteras, 464  
 Soporte para manguera en acero inoxidable, 265  
 Soporte para tapa de cubeta Gastronorm, 445  
 Soporte piña modelo apoyar, 275  
 Soporte sobre-mostrador para balanzas, 465  
 Soporte sobre-mostrador para cortadoras de fiambre, 297  
 Soportes de estantería, 10  
 Soportes de suelo, 58  
 Soportes murales para pletina, 51  
 Soportes murales para tubo, 50  
 Spout for connecting to one handle mounted valve, 276  
 Spray de acero inoxidable, 500  
 Sujeciones de hierro para tirante, 56  
 Sumidero para canal modular ranurado de salida vertical convertible a horizontal 200x200 mm., 240  
 Sumidero sifónico con cestillo salida horizontal en acero inoxidable, 239  
 Sumidero sifónico con cestillo salida vertical en acero inoxidable, 238

## T

- T mezcladora M-H-M de 1/2", 202
- Tabla de corte alta precisión, 76
- Tabla de corte/pala de fibra, 83
- Taburete con ruedas, 19, 480
- Taburete inox regulable en altura, 479
- Taburete rodante profesional en acero inoxidable, 19, 479
- Taco galvanizado para techo tipo balancín, 64
- Taco regulable, 74, 351, 489
- Taco regulable altura especial, 351, 489
- Taco regulable altura especial para tubo, 498
- Taco regulable para soporte de estantería, 498
- Tacos de plástico nylon, 63
- Tacos de plástico para tubo, 499
- Tacos regulables para tubo, 498
- Tajo con sistema de elevación, 72
- Tajo de troceo de fibra serie GE, 70
- Tajo especial barbacoa, 70
- Tajo-expositor para mostrador de pescadería, 79, 331, 336
- Tajos de troceo de fibra con faldón, 69
- Tajos de troceo de fibra lastrados, 69
- Tajos de troceo madera con faldón, 71
- Tajos de troceo madera y fibra con faldón, 71
- Taladro, 151
- Tamizador en acero inox, 160
- Tapa, 410
- Tapa antidesbordamiento inox para cubeta GN gastro-norm, 437
- Tapa hermética GN de copoliéster BPA-Free, 439
- Tapa hermética GN de polipropileno BPA-Free, 443
- Tapa juntas de unión para mesas y fregaderos, 317
- Tapa para aro de tolva de desbarasado, 500
- Tapa para barreños, 408
- Tapa para caja alimentaria apilable, 457
- Tapa para carro de manutención 481070, 322
- Tapa para cestas de lavavajillas, 459
- Tapa para cubertero plástico gris GN 1/1, 461
- Tapa para cubetas GN para identificación de alérgenos, 441
- Tapa soporte para cubos y ollas., 231
- Tapajuntas de acero inoxidable, 487
- Tapas de polipropileno GN de colores, 444
- Tapas para cubetas Gastronorm, 436
- Tapas para cubetas Gastronorm alta temperatura, 440
- Tapas para cubetas Gastronorm copoliéster, 439
- Tapas para recipientes de polipropileno, 442
- Tapón cava cromado, 172
- Tapón cobre agujeros  $\varnothing$ 42mm, 201
- Tapón de corona acero inox, 171
- Tapón fregaderos, para válvulas de  $\varnothing$  49 mm serie 600 y 700, 235
- Tapón hermético acero inox (2 uds.), 171
- Tapón inox, 171
- Tapón inox cobre-agujeros (diámetro 42 mm), 235
- Tapón vertedor inox (2 ud), 171
- Taquilla - Consigna, 488
- Taquillas de 1, 2 y 3 puertas, 348
- Taquillas de 2, 4 y 6 puertas, 349
- Taza turca inox, 410
- Temporizador digital de cocina, 364
- Tenazas quita espinas, 168
- Tendedor retráctil, 412
- Tenedor de mesa, 167
- Tenedor de trinchar, 127
- Tenedor marisco, 169
- Tenedor trinchar EC, 128
- Tensor inox de repuesto, 93
- Tensor para guantes malla, 354
- Termo, 175
- Termómetro barbacoa bluetooth con 6 sondas, 361
- Termómetro compacto, 362
- Termómetro con sonda larga, 363
- Termómetro con sonda para atornillar, 362
- Termómetro digital básico, 360
- Termómetro digital con sonda para frigorífico-congelador, 360
- Termómetro digital de acero inoxidable para horno, 360
- Termómetro digital para botella de vino, 173
- Termómetro digital pistola de infrarrojos, 362
- Termómetro digital resistente al agua, 360
- Termómetro electrónico de sonda, 361
- Termómetro infrarrojo con adaptador para columna, 417
- Termómetro infrarrojo mural, 365
- Termómetro infrarrojo para personas, 365
- Termómetro para barbacoa, 362
- Termómetro para horno con selección de programas wireless, 361
- Termómetro para lavavajillas, 364
- Termómetro pistola con sonda, 363
- Tijera desmontable multiusos, 132
- Tijera pescadero / cocina con protección, 132
- Tijera profesional, 132
- Tijeras de trinchar, 132
- Tijeras multiusos, 132
- Tijeras pescadero, 132
- Tirador para puerta abatible, 351
- Tirafondos cabeza hexagonal, 63
- Tirante a pared para grifo ducha 463052, 275
- Tirante para balanzas regulable, 57
- Tirante para colgar balanzas, 57
- Tirante, soporte a pared para grifo ducha + soporte piña, 275
- Tirantes de techo, 53
- Tirantes de techo con varilla roscada, 53
- Tirantes de techo para tubo, 54
- Tirantes de techo para tubo con varilla roscada, 55
- Tirantes para balanzas, 58
- Toallero, 411
- Tochos de hierro cincado rosca métrica, 50
- Tolva abatible para posos de café, 495
- Tolva evacuación de desperdicios para adosar a tajos de troceo, 74, 465
- Tomate, 130
- Tope de muelle para grifo ducha, 275
- Tope para fibras, 79
- Tornillo allen M6x12 (tope de muelle y tirante a pared), 275
- Tornillo allen M6x8 (Soporte piña), 275
- Tornillo cabeza allen rosca métrica, 63
- Tornillo cabeza mariposa tipo americano, 64
- Tornillo pasante con tuerca y contratuerca rosca métrica, 64
- Tornillos barraqueros con embellecedor, 63
- Tornillos cabeza hexagonal rosca métrica, 62
- Tornillos rosca chapa, 63
- Tornillos y tuercas para estantes, 11
- Tramo para canal modular o canalina, 240
- Trampa inox para grasas de 20 lts., 237
- Trampa inox para grasas de 35 lts., 237
- Trampas adhesivas, 384
- Trampas adhesivas para MR-40 (460x175 mm.), 384
- Trampas adhesivas para MR-70, 384
- Trampas adhesivas para SP-80 (395x300 mm.), 384
- Trampas adhesivas para UL-80 (450x290 mm.), 384
- Trampas adhesivas para V-30, 384
- Transformador 4000 V. repuesto para exterminadores LED, 383
- Transformador repuesto para exterminador SP-80LED, 383
- Transpaleta de acero inoxidable, 483
- Transpaleta pintada, 483
- Triángulo, 86
- Trinchar forjado, 116
- Triturador de hielo, 148
- Tubo 11 W, 383
- Tubo 15 W, 383
- Tubo 18 W, 383
- Tubo 40 W, 383
- Tubo 8 W, 383
- Tubos en escuadra, 60
- Tubos en forma de " T ", 60
- Tubos pulidos, 43
- Tuerca ciega hexagonal con autoseguro, 65
- Tuerca de repuesto para caño giratorio 1/2", 278
- Tuerca hexagonal rosca métrica con autoseguro, 65

Tuerca mariposa tipo americano, 66  
Tuerca unión mástil y válvula grifo ducha, 275

## U

U en doble T, 61  
U en forma de T, 61  
U mixta en forma de T, 61  
U sencilla, 61  
Unión en escuadra exterior, 331, 340  
Unión en escuadra interior, 341  
Unión en escuadra interior para mostradores de pescadería, 331  
Unión M-M de 1/2", 202

## V

Vaciador doble, 129  
Válvula de PVC con rebosadero, acabado cromado 1 1/2", 200  
Válvula antiretorno H-H de 1/2", 202  
Válvula con rebosadero (fregaderos serie 500 mm, lavamanos, cubetas semiesféricas y fregaderos de gran capacidad), 235  
Válvula con rebosadero para lavamanos de 450x450 mm, 200  
Válvula de desagüe Splus modelo doble, 236  
Válvula de desagüe Splus modelo simple, 236  
Válvula de descarga rápida, 235  
Válvula de dos aguas, 278  
Válvula de esfera H-H de 1/2", 202  
Válvula de PVC con rebosadero, acabado cromado, 235  
Válvula de un agua, 278  
Válvula desagüe con cestillo, 235  
Válvula desagüe de 1 1/2" para marmita, 257  
Válvula desagüe de 1" para marmita, 257  
Válvula desagüe de 2" para marmita, 257  
Válvula doble entrada, dos aguas 1/4 vuelta, 277  
Válvula doble entrada, dos aguas, monomando codo, 277

## W

WC inox, 410

## Z

Zócalo curvo de acero inoxidable, 487  
Zócalo de acero inoxidable, 487

Tuercas ciegas hexagonales rosca métrica, 65  
Tuercas hexagonales rosca métrica, 65

Universal dentado, 117  
Urinario inox, 195  
Urinarios inox, 409  
Útil de centrado para corte de fruta, 82  
Útil de montaje imagine, 31  
Útil para picadora, 85  
Útil para sujeción de jamones, 60, 103  
Utilitario, 126

Válvula dos aguas con levas 1/4 de vuelta, 277  
Válvula mezcladora antiretorno M-H-M de 1/2", 262  
Válvula mezcladora termostática H-H-M de 1/2", 261  
Válvula mezcladora termostática M-H-M de 1/2", 202  
Válvulas monomando dos aguas, 277  
Válvula monomando mural de codo monoblock para grifo ducha, 277  
Válvula mural dos aguas con levas 1/4 de vuelta, 277  
Válvula mural monomando dos aguas, 277  
Válvula sin rebosadero (fregaderos serie 500 mm), 235  
Válvula sin rebosadero Ø 49 mm (fregaderos serie 500, 600 y 700 mm), 235  
Varillas roscadas rosca métrica, 64  
Vaso en policarbonato, 167  
Verduras, 124  
Visor su turno con mando, 477  
Vitrina bollería, 467  
Vitrina bollería doble piso, 468  
Vitrina cobre aperitivos, 467  
Volteadora inox de tortilla, 142





# CONDICIONES GENERALES

GENERAL CONDITIONS  
CONDITIONS GÉNÉRALES

3.0  
3.1, 3.2, 3.3

8.0  
8.1, 8.2, 8.3, 8.4, 8.5

7.0  
7.1, 7.2

6.0  
6.1, 6.2, 6.3, 6.4, 6.5

11.0  
11.1, 11.2

10.0  
10.1, 10.2, 10.3, 10.4,  
10.5

# ■ Condiciones generales

## 1.0 Ofertas de mercancías

- 1.1 • Todos los productos incluidos en el presente catálogo están amparados por la Normativa vigente en materia de verificación y calidad exigidas por la Normativa Estatal y Europea, dentro del ámbito de la actividad empresarial de Fricosmos, S.A.
- 1.2 • El ámbito de aplicación de las presentes condiciones generales de venta abarca toda la gama de productos que Fricosmos, S.A. ha referenciado en el presente catálogo.
- 1.3 • El comprador realizará los pedidos en los términos y condiciones expresamente publicados por Fricosmos, S.A. en su página web [www.fricosmos.com](http://www.fricosmos.com). El presente catálogo puede quedar obsoleto en cualquier momento, por lo que los precios vigentes serán aquellos mostrados en la página web.
- 1.4 • Fricosmos, S.A. reserva el derecho de modificar los artículos incluidos en catálogo en función de las necesidades de la producción o de la existencia en el mercado de la materia prima para su fabricación. Por este motivo las imágenes no son contractuales.

## 2.0 Pedidos y presupuesto

- 2.1 • Los pedidos podrán efectuarse de forma verbal o por escrito, favoreciendo siempre la posibilidad de comprar a través de los servicios comerciales de Fricosmos, S.A.
- 2.2 • Una vez verificado el alta del cliente por parte de Fricosmos, S.A., se expedirá la oportuna carta de condiciones en la que se detallarán las condiciones comerciales que regirán desde ese momento entre ambas partes.
- 2.3 • El pedido queda condicionado a la aceptación definitiva por parte de Fricosmos, S. A.
- 2.4 • Todos los pedidos cuya fabricación requiera una medida especial o unas características concretas por requerimiento expreso del cliente, este vendrá obligado a garantizar el 50% del precio por adelantado. Además, este tipo de pedido no podrá ser cancelado por el cliente una vez formalizado, quedando en cualquier caso obligado al pago del 100% del pedido.
- 2.5 • La falta de pago por parte del comprador dará derecho a Fricosmos, S.A. a resolver el contrato en los términos expresamente establecidos en el artículo 1.124 del Código Civil.

## 3.0 Plazos de entrega

- 3.1 • Quedando supeditada la mercancía incluida en el presente catálogo a un proceso de fabricación del producto solicitado por el comprador, el plazo de entrega facilitado por Fricosmos, S.A. tendrá el carácter de orientativo o aproximado en el tiempo, por lo que en ningún momento el plazo indicado por nuestros agentes o por nuestra página web se podrá considerar de carácter contractual.
- 3.2 • Fricosmos, S.A. informará puntualmente al comprador del estado de elaboración de su pedido en la cadena de producción para evitar la demora del consecuente perjuicio del cliente.
- 3.3 • Los eventuales retrasos en la entrega no podrán dar lugar a penalización alguna o indemnización por daños y perjuicios, ni facultarán al comprador para anular el pedido, siempre que sea por causa imputable al proceso de fabricación.

## 4.0 Transporte de la mercancía

- 4.1 • La mercancía viajará siempre a portes debidos salvo pacto suscrito de forma expresa con cada uno de los clientes, que quedarán debidamente reflejados en la carta de condiciones que será expedida a tales efectos.
- 4.2 • Cuando la mercancía viaje a portes debidos por indicación expresa del cliente o por que así esté pactado en la carta de condiciones, Fricosmos, S.A. queda exonerado de las posibles taras o defectos que pudieran ser imputables al transporte de la mercancía.
- 4.3 • Cuando la mercancía viaje a portes pagados por Fricosmos, S.A., el cliente tiene que notificarle a Fricosmos, S.A. por escrito dentro de las 24 horas siguientes a la recepción de la mercancía, cualquier defecto o tara imputable a la agencia de transportes para facilitar la reclamación de la responsabilidad de acuerdo a la Ley 16/1.987 de Ordenación de los Transportes Terrestres y RD 1.111/1.990 por el que se aprueba el reglamento de la LOTT.
- 4.4 • No será admitida ninguna devolución de mercancía cuya tara o defecto sea imputable a la agencia de transporte, excepto que el cliente cumpla el siguiente requisito:  
Que se lo notifique a Fricosmos, S.A. y/o a la Agencia de Transportes dentro de las 24 horas siguientes a la recepción de la mercancía o en el plazo legalmente establecido en cada momento en la Ley de Ordenación de Transportes Terrestres.
- 4.5 • La reclamación contra el porteador por daño o avería, deberá hacerse en el acto del recibo de los bultos siempre que se trate de daños aparentes y dentro de las 24 horas siguientes al recibo, si los daños fuesen no aparentes. La protesta o reserva debe hacerse por escrito.

## 5.0 Entrega de mercancías

- 5.1 • La relación contractual quedará perfeccionada cuando Fricosmos, S.A. entregue la mercancía al comprador a través del medio de transporte pactado en la carta de condiciones y el comprador firme previa revisión de la mercancía, el albarán o nota de entrega.
- 5.2 • Rehusando el comprador s in causa justa, el recibo de los bienes comprados, Fricosmos, S. A. podrá pedir el cumplimiento o la rescisión del contrato, siendo los gastos originados de cuenta de quien hubiere dado motivo para constituirlo.

## 6.0 Precios y forma de pago

- 6.1 • Los precios de los productos ofertados por FRICOSMOS, S.A. dentro del ámbito de su actividad empresarial, son los contenidos en la tarifa vigente publicada en nuestra página web [www.fricosmos.com](http://www.fricosmos.com).
- 6.2 • Los precios contenidos en el catálogo no incluyen impuestos directos o indirectos, ni tasas o aranceles de naturaleza alguna.
- 6.3 • FRICOSMOS, S.A. hará constar el precio de la mercancía vendida en el presupuesto ofertado al cliente y en la factura que relaciona los productos vendidos de acuerdo con las tarifas vigentes.
- 6.4 • FRICOSMOS, S.A. y el cliente-comprador establecerán las formas de pago de las mercancías adquiridas en la carta de condiciones, y en su defecto, el precio será abonado en su integridad una vez puestas las mercancías a disposición del comprador.
- 6.5 • FRICOSMOS, S.A., se reserva el derecho a rectificar las erratas o errores materiales de que pudiera adolecer las presentes condiciones generales de venta.

## 7.0 Falta de pago

- 7.1 • Todos los retrasos en el pago del precio sobre el plazo estipulado, generarán el interés legal del dinero incrementado en 2 puntos mensualmente, y en el concepto de pena convencional.
- 7.2 • Todos los gastos que se originen, tanto judiciales como extrajudiciales, incluyendo los gastos bancarios, notariales, de abogados, de procuradores, etc., por el impago de recibos, letras de cambio, pagarés, cheques, etc., se pagarán por la parte compradora.

## 8.0 Garantía de los productos fabricados por fricosmos, S.A.

- 8.1 • Todos los productos incluidos en nuestro catálogo, gozan de una garantía de DOS AÑOS contado a partir de la fecha de entrega de la mercancía.
  - 8.1.1 • Los productos fabricados por Fricosmos, S.A. que pudieran adolecer de algún defecto de fabricación, serán reparados o sustituidos por otro de iguales características, siempre que por parte del cliente se cumplan en debida forma los requisitos que con toda claridad y precisión se detallan a continuación:
    - 1) Que el cliente avise por escrito a Fricosmos, S.A. de la existencia de un posible defecto.
    - 2) Que la pieza que tiene que ser sustituida sea enviada a la sede de nuestra empresa para su oportuna revisión.
    - 3) Que el cliente abone los portes de ida y vuelta de la pieza que tiene que ser susceptible de reposición o reparación.
    - 4) El cliente goza de una garantía en todos los productos que adquiera, que despliega sus efectos dentro de la instalación comercial de FRICOSMOS, S.A. pero en ningún caso podrá asumirse en el exterior.
- 8.2 • Los servicios técnicos de Fricosmos, S.A. asumen la responsabilidad de examinar la pieza o mercancía remitida por el cliente para corroborar la existencia de un posible defecto de fabricación.
- 8.3 • Si del dictamen de la oficina técnica de Fricosmos, S.A. se determina la existencia de un defecto de fabricación, Fricosmos, S.A. vendrá obligado a sustituir o reparar la mercadería que fue comprada por el cliente, le será enviada al domicilio social que figure en el albarán originario sin coste alguno para el cliente excepto los portes.
- 8.4 • Las piezas o materiales serán siempre sustituidos por otros de iguales características o calidades.
- 8.5 • El cambio o la sustitución de las piezas defectuosas no incluyen ni la instalación ni la mano de obra que haya de ser realizada por terceras personas.
- 8.6 • El cliente tiene pleno derecho a recibir información técnica del dictamen emitido por el fabricante.
- 8.7 • Quedan excluidos de garantía los consumibles, como por ejemplo los tubos fluorescentes, bombillas, lámparas de ozono, etc.

## 9.0 Reclamaciones

Las posibles reclamaciones acerca del estado o cantidad de la mercancía, se efectuarán por escrito, enviando un email a nuestro *Departamento de Asistencia* (asistencia@fricosmos.com) en el plazo de 24h desde su recepción y de acuerdo a los puntos 4.3 y 4.4. Se deberá indicar a cada reclamación el número de albarán y en caso de tratarse de problemas físicos de la mercancía recibida, se adjuntarán imágenes y/o vídeos donde se muestren tales defectos.

## 10.0 Devolución de mercancías

- 10.1 • La devolución de material deberá ser autorizada por nuestro Departamento de Asistencia, que indicará al cliente el número de caso / autorización para gestionar la devolución. El material deberá devolverse referenciado con el nº de caso visible y notificado a la empresa de transporte. Sin esta información no se admitirá ningún tipo de mercancía en nuestro almacén.
- 10.2 • No se admitirá en ningún caso, la devolución de materiales usados, sin plástico protector, los probados o los encargados a medida.
- 10.3 • Todos los gastos de retorno de la mercancía a devolver, manipulación, embalajes y seguro, correrán por parte del comprador, siendo estos los encargados de reclamar los daños o pérdidas que se pudieran ocasionar.
- 10.4 • Fricosmos se reserva el derecho de admisión de la devolución hasta su inspección de calidad y cantidad de la mercancía en nuestras instalaciones de Móstoles.
- 10.5 • Toda devolución genera un *saldo a favor* del cliente, que será descontado en la siguiente o siguientes compras.

## 11.0 Reserva de dominio

- 11.1 • El vendedor se reserva el dominio de la mercancía vendida hasta el pago completo de todas las cantidades que el comprador le adeude.
- 11.2 • El vendedor se reserva el derecho de dar por rescindido el contrato si el comprador no cumpliera cualquiera de las condiciones Generales de Venta, reseñadas en virtud de ello, exigir los reintegros, garantías o indemnización de perjuicios que conviniera a sus intereses o hubiera lugar en derecho.

## 12.0 Legislación aplicable

La interposición de las presentes Condiciones de Venta se encuentra amparada en el Código Civil y en el Código de Comercio, así como en la Ley 7/1998 de 13 de Abril de Condiciones General de la Contratación y en la Ley 16/1987 de 30 de Julio de Ordenación de los Transportes Terrestres.

## 13.0 Jurisdicción

- 13.1 • El contrato de compraventa se entenderá siempre realizado en España, rigiéndose por la normativa legal Española en todo lo no previsto en las presentes condiciones generales de venta.
- 13.2 • Cualquier divergencia surgida como consecuencia del contrato de venta establecido, deberá ser resuelta ante los juzgados y tribunales de Móstoles (Madrid), a cuyo fuero se someten expresamente comprador y vendedor, renunciando de manera expresa al que pudiera corresponderles.
- 13.3 • Queda especialmente convenido que todos los giros impagados o los plazos vencidos serán reclamados, así como la acción ejecutiva que de ellos dimana, ante los juzgados o tribunales de Móstoles (Madrid) España, aunque sea otro el domicilio del aceptante o el lugar de pago indicado en las letras.

## 1.0 Merchandise offer

- 1.1 • Every product included in the current catalogue are according to the current rules as regards verification and quality required by the National and European Regulations, within Fricosmos' business context.
- 1.2 • All the range of products that Fricosmos, S.A. has indexed in the current catalogue are within the limits of application of the current General Conditions of Sale.
- 1.3 • The buyer will place the orders under the terms and conditions expressly published by Fricosmos, S.A. on its website [www.fricosmos.com](http://www.fricosmos.com). This catalog may become obsolete at any time, so the current prices will be those shown on the website.
- 1.4 • Fricosmos, S.A. reserves the right to modify the articles included in the catalog according to the needs of production or the existence in the market of the raw material for their manufacture. For this reason, the images are not contractual.

## 2.0 Quotations and orders

- 2.1 • Orders will be effected verbally or in writing, favouring always the possibility of purchasing through the commercial service of Fricosmos, S.A.
- 2.2 • Once verified the registration of the customer by Fricosmos, S.A., the corresponding letter of conditions will be issued, detailing the commercial conditions that will rule in the future for both parties.
- 2.3 • The order will be subject to the definite acceptance of Fricosmos, S.A.
- 2.4 • All orders with bespoke items (whose fabrication requires any specific characteristics upon request of the buyer), will be obliged to secure 50% of the price in advance by the buyer. In addition, these kinds of orders are not subject to cancellation by the buyer once placed and will be still obliged to pay 100% of the order.
- 2.5 • The lack of payment by party of the purchaser will entitle Fricosmos, S.A. to dissolve the contract in the terms expressly established in the article 1124 of the Spanish Código Civil.

## 3.0 Delivery time

- 3.1 • As the merchandise included in this catalog is subject to a manufacturing process of the product requested by the buyer, the delivery time provided by Fricosmos, S.A. will be approximate or for guidance only, so that the period stated by our agents or by our website will not be considered contractual under any circumstance.
- 3.2 • Fricosmos, S.A. will inform reliably to the purchaser about the manufacturing progress of his order in the assembly line in order to avoid delaying a possible harm to the customer.
- 3.3 • The punctual delivery delay will not cause any penalty or compensation, nor entitle the purchaser to cancel the order, as long as it is due to the manufacturing process.

## 4.0 Merchandise transport

- 4.1 • The merchandise will ever be shipped ex works except agreement subscribed expressly with every customer, which will be duly reflected in the letter of conditions issued for this purpose.
- 4.2 • In case that the carriage of the merchandise is paid following the customer instructions or because is so stipulated in the letter of conditions, Fricosmos, S.A. will be exonerated of any possible defect or fault that could be attributed to the transport of the merchandise.
- 4.3 • In case that the carriage of the merchandise is paid by Fricosmos, S.A., the customer must notify Fricosmos, S.A. in writing and within 24 hours after the reception of the merchandise any defect or fault attributed to the shipping agent in order to make easier the responsibility claim in accordance to the regulation 16/1987 of the Spanish Ordenación de los Transportes Terrestres and the RD 1111/1990 by which the regulation of the LOTT is approved.
- 4.4 • No merchandise returns will be admitted if the defect or fault is attributed to shipping agent except in case that the customer complies the following requirement: That he notifies the incidence to Fricosmos, S.A. and/or to the shipping agent within 24 hours after the reception of the merchandise or within the period legally determined at the time of the shipment by the Spanish Ley de Ordenación de Transportes Terrestres.
- 4.5 • The claim against the shipping agent for defect or fault must be done at the reception of the goods whenever there are apparent damages and within 24 hours after their reception if they are non-apparent. The claim must be done in writing.

## 5.0 Delivery of the merchandise

- 5.1 • The contractual relationship will be completed once Fricosmos, S.A. delivers the merchandise to the buyer through the means of transport agreed in the letter of conditions and the buyer signs, after verification of the merchandise, the proof of delivery.
- 5.2 • If the purchaser rejects the reception of the sold goods without a just cause, Fricosmos, S.A. will be entitled to demand the expiration or cancellation of the contract, and the expenses will be charged on the account of the party that would have originated it.

## 6.0 Prices and way of payment

- 6.1 • The prices of the products offered by FRICOSMOS, S.A. within the scope of its business activity, are those contained in the existing price list published on our website [www.fricosmos.com](http://www.fricosmos.com).
- 6.2 • The prices included in the catalogue does not include direct or indirect taxes, nor rates or duties.
- 6.3 • Fricosmos, S.A. will reflect the price of every merchandise sold in the offer quoted to the customer and in the invoice listing the sold products in accordance with the valid price-list.
- 6.4 • Fricosmos and the customer-purchaser will establish the means of payment for the acquired merchandises in the letter of conditions, and in default, the price will be fully charged once the merchandise at the purchaser disposition.
- 6.5 • Fricosmos, S.A. reserves the right to rectify the mistakes or material errors which could present the current general conditions of sale.

## 7.0 Arrears of payment

- 7.1 • All arrear in payment over the stipulated period will generate the legal currency interest increased in 2 points per month in concept of conventional penalty.
- 7.2 • All expenses originated in the failure of payment of accounts, bills of exchange, bonds, cheques, as much judicial as out-of-law, including expenses for bank, notary, lawyer, solicitor etc. will be charged to the purchaser party.

## 8.0 Warranty of the products manufactured by Fricosmos, S.A.

- 8.1 • All products included in our catalogue are guaranteed for TWO YEARS from the delivery date on.
  - 8.1.1 • The products manufactured by Fricosmos, S.A. that could have suffered any manufacture defect will be repaired or substituted by another of the same characteristics whenever the customer carries out all the requirements clearly detailed below:
    - 1| The customer must notify in writing to Fricosmos the existence of an eventual defect.
    - 2| The piece to be substituted must be shipped to our facilities for its corresponding inspection.
    - 3| The customer must pay the transport of the item to be repaired to and from our facilities.
    - 4| The customer can make effective his guarantee right on our products within Fricosmos facilities only. It will never be accepted outside them.
- 8.2 • Fricosmos Technical Service takes on the responsibility of inspecting the piece or merchandise received from the customer to corroborate the existence of a possible defect of manufacture.
- 8.3 • If the final report of the Technical Service of Fricosmos, S.A. determines the existence of a defect of manufacture, Fricosmos, S.A. will be obliged to substitute or repair the merchandise acquired by the customer, and it will be resent to the delivery note original address without any additional cost, except the transport.
- 8.4 • Pieces or materials will always be substituted by another of the same characteristics or quality.
- 8.5 • The change or substitution of the defect parts do not include neither installing or labour which must be done by a third party.
- 8.6 • The customer has full right to receive technical information about the report issued by the manufacturer.
- 8.7 • All the consumable products such as fluorescent tubes, bulbs, ozone lamps, etc. are excluded from this warranty.

## 9.0 Claims

Any eventual claim regarding the state or quantity of the merchandise shall be made in writing, by sending an email to our *Assistance Department* (assistance@fricosmos.com) within 24 hours from the delivery and in accordance with points 4.3 and 4.4. The delivery note number must be stated to each claim and in case of visible defects or damages of the merchandise received, images and / or videos showing them will be attached.

## 10.0 Returns of merchandise

- 10.1 • The return of material must be authorized by our Assistance Department, who will provide to the buyer a case / authorization number to manage the return. The case number must be visible on the returned packages and notified to the transport company. No returns of merchandise will be accepted in our warehouse without this information.
- 10.2 • Fricosmos, S.A. will not accept under any circumstance the return of used, tested, without protective plastic or custom-made material.
- 10.3 • The purchaser will take care of all costs of shipping, handling, packaging and insurance to return the goods and will be responsible for claiming any damage or loss that may result from this circumstance.
- 10.4 • Fricosmos reserves the right to refuse de admission of the returned goods until their inspection for quality and quantity in our facilities in Móstoles.
- 10.5 • Any return that generates a *balance in favor* of the customer will be deducted from the next or subsequent purchases.

## 11.0 Reserve of property

- 11.1 • The vendor reserves the right of ownership of the purchased goods until the full amount that is owed by the purchaser is paid.
- 11.2 • The vendor reserves the right to terminate the contract if the purchaser does not comply with all of the General Conditions of Sale mentioned. By virtue of this, Fricosmos, S.A. is entitled to demand the payment, warranties or compensation for damages suitable to their interests.

## 12.0 Applicable legislation

- 12.1 • The insertion of the current Sales conditions is in accordance with the Spanish Código Civil and the Código de Comercio, as well as with the regulations 7/1998 from 13th April on the Spanish Condiciones Generales de Contratación and 16/1987 from 30th July on the Ordenación de los Transportes Terrestres.

## 13.0 Jurisdiction

- 13.1 • The contract of sale is always understood to be executed in Spain and is governed by the legal norms of Spain in all aspects non covered by the current General Conditions of Sale.
- 13.2 • Any divergence arising as a consequence of an established contract of sale must be resolved by the Courts and Tribunals of Móstoles (Madrid), to whose jurisdiction both the purchaser and the vendor are expressly subjected, and renouncing expressly to any other which might correspond to them.13.3 It is expressly agreed that all unpaid accounts or installment payments due will be reclaimed, as well as the executive action arising from them, before the Courts and Tribunals of Móstoles (Madrid) España, even if the address of the acceptor is elsewhere or the place of payments indicated in correspondence is elsewhere.



## 1.0 Offre de marchandises

- 1.1 • Tous les produits inclus dans ce catalogue-ci sont soutenus par la réglementation en vigueur en affaire de vérification et qualité exigé par la loi de l'Etat Espagnol et l'Union Européenne, dans le cadre de l'activité commerciale de Fricosmos, S.A.
- 1.2 • Le cadre d'application de ces conditions générales de vente comprend toute la gamme des produits de ce catalogue.
- 1.3 • L'acheteur passera les commandes selon les termes et conditions expressément publiés par Fricosmos, S.A. sur son site internet [www.fricosmos.com](http://www.fricosmos.com). Ce catalogue peut devenir obsolète à tout moment, les prix en vigueur seront donc ceux indiqués sur le site.
- 1.4 • Fricosmos, S.A. se réserve le droit de modifier les articles inclus dans le catalogue en fonction des besoins de production ou de l'existence sur le marché de la matière première pour leur fabrication. Pour cette raison les images ne sont pas contractuelles.

## 2.0 Commandes et offres

- 2.1 • Les commandes pourront s'effectuer de façon verbale ou écrite, tout en favorisant la possibilité d'acheter à travers de tous les services commerciaux de Fricosmos, S.A.
- 2.2 • Une fois l'inscription du client soit vérifiée par Fricosmos, S.A., on expédiera la lettre de conditions opportune dans laquelle on détaillera les conditions commerciales qui régiront dès ce moment entre les deux parties.
- 2.3 • La commande est conditionnée à l'acceptation définitive par Fricosmos, S.A.
- 2.4 • Toutes commandes dont la fabrication nécessite une mesure particulière ou des caractéristiques particulières à la demande exprime du client, ce dernier sera tenu de garantir 50% du prix d'avance. De plus, ce type de commande ne peut être annulé par le client une fois celle-ci formalisée, étant en tout état de cause tenu de payer 100% de la commande.

## 3.0 Délais de livraison

- 3.1 • La marchandise figurant dans ce catalogue étant soumise à un procédé de fabrication du produit demandé par l'acheteur, le délai de livraison prévu par Fricosmos, S.A. Il sera à titre d'orientation ou approximatif dans le temps, de sorte qu'à aucun moment le délai indiqué par nos agents ou par notre site internet ne pourra être considéré comme contractuel.
- 3.2 • Fricosmos, S.A. informera à l'acheteur ponctuellement de l'état d'élaboration de sa commande dans la chaîne de production pour éviter le retard et le conséquent préjudice au client.
- 3.3 • Les retards de livraison éventuels ne pourront pas donner lieu à aucune sanction ou indemnisation par dommages et intérêts. Ils n'autoriseront pas non plus à annuler la commande, quand le retard soit imputable au procès de fabrication.

## 4.0 Transport de la marchandise

- 4.1 • La marchandise voyagera toujours à ports dus sauf accord suscrit expressément avec chacun des clients, ce qui restera dûment exprimé dans la lettre de conditions qui sera expédiée au client.
- 4.2 • Quand la marchandise voyage à ports dus par désir exprès du client ou parce que dans la lettre de conditions on a fait ce pacte, Fricosmos, S.A. est exonéré des possibles tares ou défauts qui pourront être imputables au transport de la marchandise.
- 4.3 • Quand la marchandise voyage à ports payés par Fricosmos, S.A., le client doit notifier à Fricosmos, S.A. par écrit dans les 24 heures suivantes à la réception de la marchandise de n'importe quel défaut ou tare imputable à la compagnie de transports pour faciliter la réclamation de la responsabilité dans le cadre de la loi espagnole 16/1.987 d'Ordonnances des Transports Terrestres et Royal Décret espagnol 1.111/1.990 par lequel s'approuve le règlement de la LOTT (loi d'Ordonnances des Transports Terrestres).
- 4.4 • On n'admettra pas dévolution de marchandise avec une tare ou un défaut imputable à la compagnie de transport, sauf que le client accomplisse la condition suivante : Notifier à Fricosmos, S.A. et / ou à l'agence de transport dans les 24 heures suivantes à la réception de la marchandise ou dans le délai établi légalement à chaque moment dans la Loi d'Ordonnances des Transports Terrestres espagnole.
- 4.5 • La réclamation contre la compagnie de transport par dommage ou panne, devra se faire à la réception des colis quand il s'agit de dommages apparents et dans les 24 heures suivantes à la réception si les dommages ne sont pas apparents. La plainte ou réserve doit se faire par écrit.

## 5.0 Remise de marchandises

- 5.1 • La relation contractuelle sera parfaite lorsque Fricosmos, S.A. livrera la marchandise à l'acheteur par le moyen de transport convenu dans le cahier des charges et l'acheteur signe après avoir pris connaissance de la marchandise, le bon de livraison ou la note de bon de livraison.
- 5.2 • Dans le cas où l'acheteur refuse la marchandise sans une cause juste à la réception des biens achetés, Fricosmos, S.A. pourra demander l'accomplissement ou la résiliation du contrat. Les frais dérivés seront à la charge de la personne qui ait donné le motif pour les constituer.

## 6.0 Prix et mode de paiement

- 6.1 • Les prix des produits proposés par FRICOSMOS, S.A. Dans le cadre de son activité, il s'agit du contenu du tarif en vigueur publié sur notre site internet [www.fricosmos.com](http://www.fricosmos.com).
- 6.2 • Les prix contenus dans le catalogue n'incluent pas des impôts directs ou indirects, ni des taxes ni des tarifs douaniers d'aucune nature.
- 6.3 • Fricosmos, S.A. fera figurer le prix de la marchandise vendue dans le devis offert au client et dans la facture qui réfléchira les produits vendus d'accord aux tarifs en vigueur.
- 6.4 • Fricosmos, S.A. et le client-acheteur établiront les façons de paiement des marchandises acquises dans la lettre de conditions, et à défaut de cette lettre, le prix sera payé intégralement une fois les marchandises sont mis à disposition de l'acheteur.
- 6.5 • Fricosmos, S.A. réserve le droit de rectifier les erratum ou les fautes matérielles qui pourront exister dans ces conditions générales de vente.

## 7.0 Manque de paiement

- 7.1 • Tous les retards dans le paiement du prix au-dessus du délai stipulé, généreront l'intérêt légal de l'argent augmenté deux points à chaque mois à titre de sanction conventionnelle.
- 7.2 • Tous les frais qui se génèrent, soit judiciaires, soit extra judiciaires, tout en incluant les frais bancaires, notariaux, d'avocats, de huissiers etc. par la manque de paiement de reçus, lettres de change, traites, chèques, billets à l'ordre etc. seront payés par la part acheteuse.

## 8.0 Garantie des produits fabriqués par Fricosmos, S.A.

- 8.1 • Tous les produits inclus dans ce catalogue ont une garantie DEUX ANS à partir de la date de remise de la marchandise.
  - 8.1.1 • Les produits fabriqués par Fricosmos, S.A. qui pourront avoir quelque défaut de fabrication seront réparés ou substitués par un autre des mêmes caractéristiques, pourvu que le client aie accompli les conditions qui avec précision sont détaillés ci-dessous:
    - 1| Que le client notifie par écrit à Fricosmos, S.A. de l'existence d'un éventuel défaut.
    - 2| Que la pièce à substituer soit envoyé à l'adresse de notre société pour une révision.
    - 3| Que le client paie le transport d'aller et de retour de la pièce qui va se réviser ou réparer.
    - 4| Le client a une garantie dans tous les produits qu'il achète qui n'est valable que dans l'installation commerciale de Fricosmos, S.A. Fricosmos, S.A. ne pourra pas assumer une garantie à l'extérieur des installations de Fricosmos, S.A.
- 8.2 • Les services techniques de Fricosmos, S.A. assument la responsabilité d'examiner la pièce ou marchandise envoyé par le client pour corroborer l'existence d'un éventuel défaut de fabrication.
- 8.3 • Si le rapport des techniciens de Fricosmos, S.A. détermine l'existence d'un défaut de fabrication, Fricosmos, S.A. sera obligé de substituer ou réparer la marchandise achetée par le client, et elle sera envoyée à l'adresse du bon de livraison original sans coût additionnel pour le client, sauf le transport.
- 8.4 • Les pièces ou matériaux seront toujours substitués par des autres avec les mêmes caractéristiques ou qualités.
- 8.5 • Le changement ou substitution des pièces avec des défauts n'inclut pas l'installation ni la main d'œuvre de troisièmes parties.
- 8.6 • Le client a plein droit à recevoir des renseignements techniques sur le rapport émis par le fabricant.
- 8.7 • Tous les produits consommables tels que les tubes fluorescents, ampoules, lampes d'ozone, etc sont exclus de cette garantie.

## 9.0 Réclamations

Les éventuelles réclamations concernant le statut ou la quantité de la marchandise seront formulées par écrit, en adressant un courrier électronique à notre *Service d'Assistance* ([assistance@fricosmos.com](mailto:assistance@fricosmos.com)) dans les 24 heures suivant la réception et conformément aux points 4.3 et 4.4. Le numéro du bon de livraison doit être indiqué pour chaque réclamation et en cas de problèmes physiques de la marchandise reçue, des images et/ou vidéos montrant de tels défauts seront jointes.

## 10.0 Dévolution de marchandises

- 10.1 • Le retour de matériel doit être autorisé par notre Service d'Assistance, qui indiquera au client le numéro de dossier/autorisation pour gérer le retour. Le matériel doit être retourné référencé avec le numéro de cas visible et notifié au transporteur. Sans ces informations, aucun type de marchandise ne sera accepté dans notre entrepôt.
- 10.2 • Fricosmos, S.A. n'admettra aucune dévolution de matériaux usagés, éprouvés ou commandés sur mesure.
- 10.3 • Tous les frais de transport, la manutention, l'emballage et l'assurance pour retourner la marchandise seront à la charge de l'acheteur, qui sera aussi responsable de réclamer tout dommage ou perte qui pourrait résulter de cette circonstance.
- 10.4 • Fricosmos se réserve le droit de refuser l'admission des marchandises retournées jusqu'à leur inspection de la qualité et la quantité dans nos installations à Móstoles.
- 10.5 • Tout retour génère un *solde en faveur* du client, qui sera décompté lors des achats suivants ou ultérieurs.

## 11.0 Réserve de propriété

- 11.1 • Le vendeur se réserve la propriété des marchandises vendues jusqu'au paiement complet de toutes les quantités dues par l'acheteur.
- 11.2 • Le vendeur se réserve le droit d'annuler le contrat si l'acheteur n'exécute pas une ou plusieurs des conditions générales de vente, ici signalées, d'exiger les remboursements, les garanties ou l'indemnisation des dommages qui conviennent à ses intérêts qu'il y ait lieu en droit.

## 12.0 Législation applicable

L'interposition de ces conditions de vente est encadrée dans le Code Civil, dans le Code de Commerce, dans la loi espagnole 7/1.998 du 13 avril de « Condiciones Generales de la Contratación » et dans la loi espagnole 16/1.987 de 30 juillet de Ordenación de los Transportes Terrestres

## 13.0 Jurisdiction

- 13.1 • Le contrat de vente sera entendu comme réalisé toujours en Espagne, s'y appliquant la normative légale espagnole en tout ce qui n'est pas prévu dans les présentes conditions générales de vente.
- 13.2 • Toute divergence qui puisse surgir comme conséquence du contrat de vente établi devra être solutionnée devant les tribunaux de Móstoles (Madrid) Espagne, auxquels se soumettent de forme expresse tant l'acheteur que le vendeur, renonçant expressément à ceux qui en fait pourrait leur correspondre.
- 13.3 • Il est surtout convenu que tous les virements non payés ou les délais échus seront demandés, ainsi que l'acte d'exécution qui en dérive, devant les tribunaux de Móstoles (Madrid) Espagne, même quand le domicile de l'acceptant ou l'endroit du paiement des lettres soit ailleurs.





[www.FRICOSMOS.com](http://www.FRICOSMOS.com)

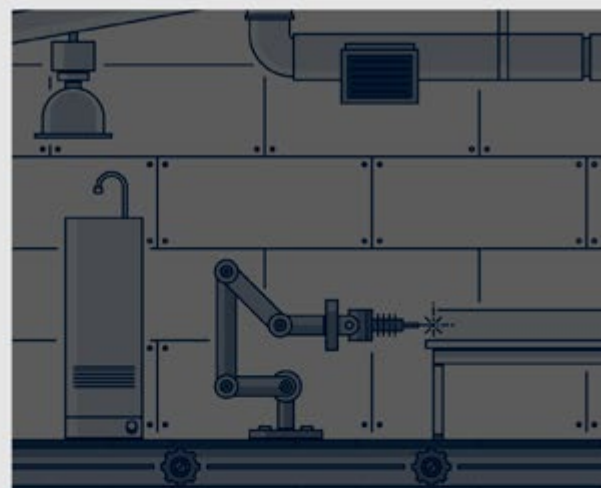

Fricosmos, S. A.  
Polígono industrial nº 1  
C/ Cámara de la Industria, 11A  
28938 Móstoles (Madrid)  
ESPAÑA  
[www.fricosmos.com](http://www.fricosmos.com)



[info@fricosmos.com](mailto:info@fricosmos.com)